

EPIC® Rectangular Connectors

HBE 6 Plugs & Receptacles



HBE 6 SCREW & CRIMP TERMINATED INSERTS

SCREW TERMINATED

CRIMP TERMINATED

View from Cable Side

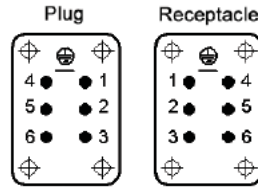

Contacts Sold Separately

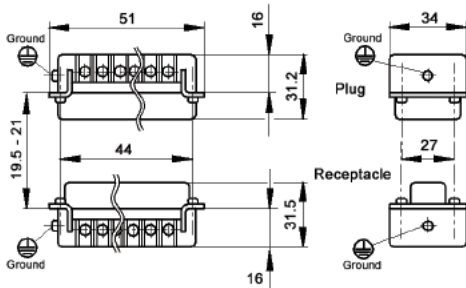

All dimensions are in mm.

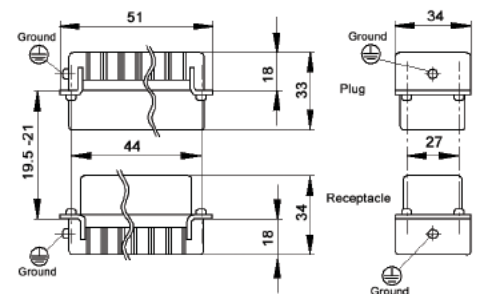

Description	Plug	Receptacle
Screw Terminated with wire protection	10190000	10191000
Screw Terminated without wire protection	10190100	10191100
Crimp Terminated: Machine	10180000	10181000



MACHINED CONTACTS: DIAMETER 2.5 MM²

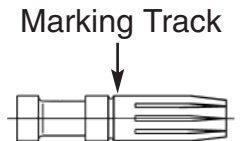
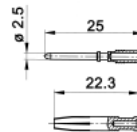

Bags of 100							
mm ²	AWG	Silver		Gold		Stripping Length (mm)	# of Marking Tracks
		Pin	Socket	Pin	Socket		
0.5	20	11190000	11195000	11192000	11197000	Pin=7.4, Socket =7.3	-
.75 - 1.0	18	11190100	11195100	11192100	11197100	Pin=7.4, Socket =7.3	1
1.5	16	11190200	11195200	11192200	11197200	Pin=7.4, Socket =7.3	2
2.5	14	11190300	11195300	-	-	Pin=7.4, Socket =7.3	3
4.0	12	11190400	11195400	-	-	Pin=7.4, Socket =7.3	-

Part number= 1 contact



Crimp Tool
11147000



Crimp Dies
11147100



Locator
11147200

For removal of contacts use a slotted screwdriver.
No special tool is necessary.

Please note that the crimp range for this tool is 0.14 to 4.0 mm² (AWG 26 - 12) with the appropriate crimp dies.

EPIC® Rectangular Connectors

HBE 10 Plugs & Receptacles



HBE 10 SCREW & CRIMP TERMINATED INSERTS

SCREW TERMINATED



View from Cable Side

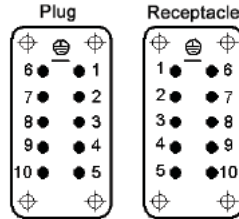

CRIMP TERMINATED



Contacts Sold Separately

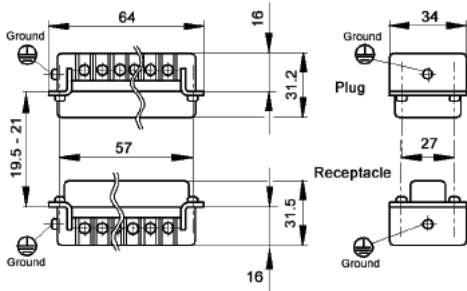

All dimensions are in mm.

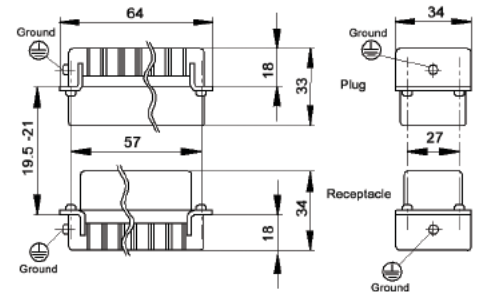

Description	Plug	Receptacle
Screw Terminated with wire protection	10192000	10193000
Screw Terminated without wire protection	10192100	10193100
Crimp Terminated: Machine	10182000	10183000



MACHINED CONTACTS: DIAMETER 2.5 MM²

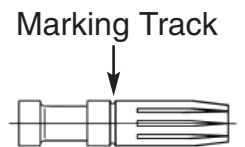
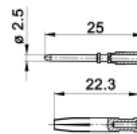

mm ²	AWG	Bags of 100				Stripping Length (mm)	# of Marking Tracks
		Silver		Gold			
		Pin	Socket	Pin	Socket		
0.5	20	11190000	11195000	11192000	11197000	Pin=7.4, Socket =7.3	-
.75 - 1.0	18	11190100	11195100	11192100	11197100	Pin=7.4, Socket =7.3	1
1.5	16	11190200	11195200	11192200	11197200	Pin=7.4, Socket =7.3	2
2.5	14	11190300	11195300	-	-	Pin=7.4, Socket =7.3	3
4.0	12	11190400	11195400	-	-	Pin=7.4, Socket =7.3	-

Part number= 1 contact



Crimp Tool
11147000



Crimp Dies
11147100



Locator
11147200

For removal of contacts use a slotted screwdriver.
No special tool is necessary.

Please note that the crimp range for this tool is 0.14 to 4.0 mm² (AWG 26 - 12) with the appropriate crimp dies.

EPIC® Rectangular Connectors

HBE 16 Plugs & Receptacles



HBE 16 SCREW & CRIMP TERMINATED INSERTS

SCREW TERMINATED



View from Cable Side

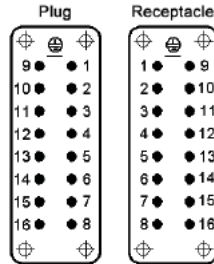

CRIMP TERMINATED



Contacts Sold Separately

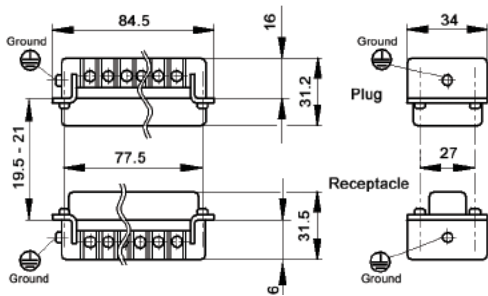

All dimensions are in mm.

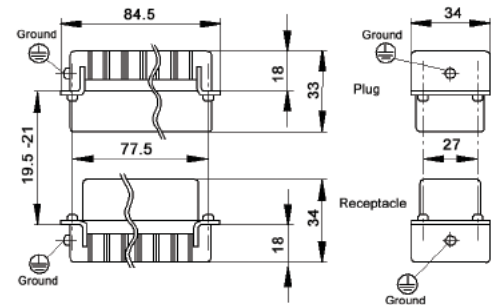

Description	Plug	Receptacle
Screw Terminated with wire protection	10194000	10195000
Screw Terminated without wire protection	10194100	10195100
Crimp Terminated: Machine	10184000	10185000



MACHINED CONTACTS: DIAMETER 2.5 MM²



Bags of 100							
mm ²	AWG	Silver		Gold		Stripping Length (mm)	# of Marking Tracks
		Pin	Socket	Pin	Socket		
0.5	20	11190000	11195000	11192000	11197000	Pin=7.4, Socket =7.3	-
.75 - 1.0	18	11190100	11195100	11192100	11197100	Pin=7.4, Socket =7.3	1
1.5	16	11190200	11195200	11192200	11197200	Pin=7.4, Socket =7.3	2
2.5	14	11190300	11195300	-	-	Pin=7.4, Socket =7.3	3
4.0	12	11190400	11195400	-	-	Pin=7.4, Socket =7.3	-

Part number= 1 contact



Crimp Tool
11147000



Crimp Dies
11147100



Locator
11147200

For removal of contacts use a slotted screwdriver.
No special tool is necessary.

Please note that the crimp range for this tool is 0.14 to 4.0 mm² (AWG 26 - 12) with the appropriate crimp dies.

EPIC® Rectangular Connectors

HBE 6 Housings: Single Lever on Base



HOODS

TOP ENTRY

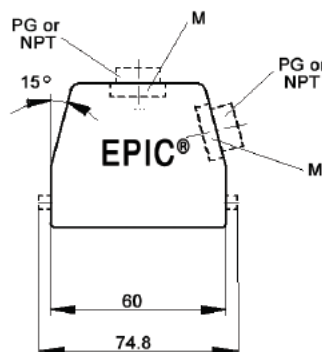
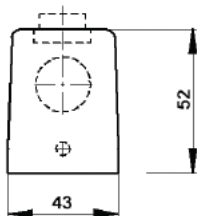

SIDE ENTRY



All dimensions are in mm.

Specifications: DIN 43652
Temperature Range: -40°C to +125°C
Protection class: NEMA 4, NEMA 12, IP65
Material: Aluminum alloy, powder coated

Position of Cable Entry	Size of Entry			Part Numbers			Complete your installation with a SKINTOP®, Pg 352			
	PG	NPT	Metric	PG	NPT	Metric	PG- Nylon	PG- Metal	Metric- Nylon	Metric- Metal
Top Entry	13.5	1/2"	20	10011000	100110NP	19011000	53015130	52015700	53111020	53112020
	16	1/2"	25	10021000	100210NP	19021000	53015140	52015740	53111030	53112030
Side Entry	13.5	1/2"	20	10012000	100120NP	19012000	53015130	52015700	53111020	53112020
	16	1/2"	25	10022000	100220NP	19022000	53015140	52015740	53111030	53112030

Top Entry metric hoods do not come with a neck.

HIGH PROFILE HOODS

TOP ENTRY

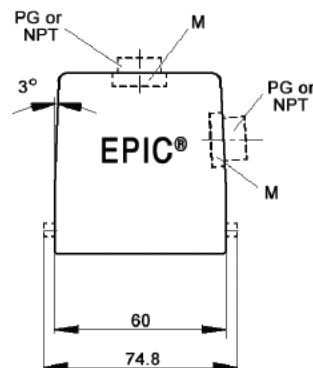
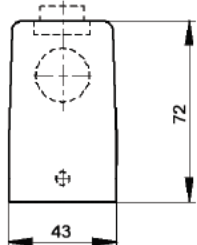

SIDE ENTRY



All dimensions are in mm.

Specifications: DIN 43652
Temperature Range: -40°C to +125°C
Protection class: NEMA 4, NEMA 12, IP65
Material: Aluminum alloy, powder coated

Position of Cable Entry	Size of Entry			Part Numbers			Complete your installation with a SKINTOP®, Pg 352			
	PG	NPT	Metric	PG	NPT	Metric	PG- Nylon	PG- Metal	Metric- Nylon	Metric- Metal
Top Entry	21	3/4"	25	70020200	700202NP	79020200	53015150	52015750	53111030	53112030
	29	1"	32	70020400	700204NP	79020400	53015160	52015760	53111040	53112040
Side Entry	21	3/4"	25	70022200	700222NP	79022200	53015150	52015750	53111030	53112030
	29	1"	32	70022400	700224NP	79022400	53015160	52015760	53111040	53112040

High Profile Metric hoods do not come with a neck.

EPIC® Rectangular Connectors



HBE 6 Housings: Single Lever on Base

PANEL MOUNT BASES

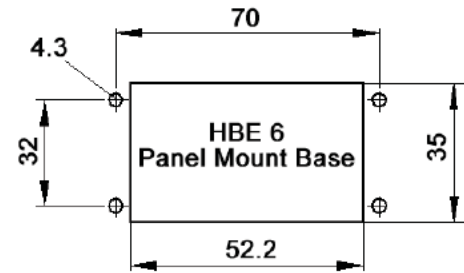
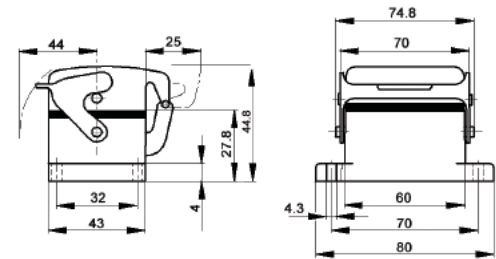

All dimensions are in mm.

Specifications: DIN 43652
Temperature Range: -40°C to +125°C
Protection class: NEMA 4, NEMA 12, IP65
Material: Aluminum alloy, powder coated

Description	Part Numbers
Panel Mount without Dust Cover	100030C0
Panel Mount with Dust Cover	100040C0

SURFACE MOUNT BASES

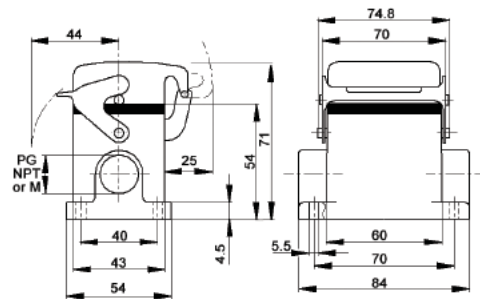

Specifications: DIN 43652
Temperature Range: -40°C to +125°C

All dimensions are in mm.

Protection class: NEMA 4, NEMA 12, IP65
Material: Aluminum alloy, powder coated

# of Entries	Size of Entry			Part Numbers			Complete your installation with a SKINTOP®, Pg 352			
	PG	NPT	Metric	PG	NPT	Metric	PG- Nylon	PG-Metric	Metric- Nylon	Metric- Metal
2 Entries	16	1/2"	20	100060C0	100060NP	19006000	53015140	52015740	53111020	53112020
1 Entry	16	1/2"	20	100050C0	100050NP	19005000	53015140	52015740	53111020	53112020
	-	-	25	-	-	79005600	-	-	53111030	53112030
2 Entries with dust cover	16	1/2"	20	100090C0	100090NP	19009000	53015140	52015740	53111020	53112020
	-	-	25	-	-	79016600	-	-	53111030	53112030
1 Entry with dust cover	16	1/2"	20	100070C0	100070NP	19007000	53015140	52015740	53111020	53112020
	-	-	25	-	-	79015600	-	-	53111030	53112030

DUST COVERS WITH ATTACHMENT STRING



Material: Thermoplastic Resin

Temperature: -40°C to 125°C

	Part #
Dust cover with single lever and gasket for HBE 6 Hoods	10016500
Dust cover with single lever bolts for HBE 6 Panel Mount or Surface Mount Base/ Cable Coupler Hood	10015000

EPIC® Rectangular Connectors



HBE 10 Housings: Single Lever on Base

HOODS

TOP ENTRY

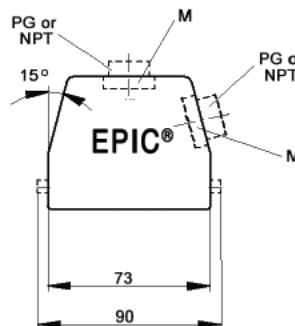
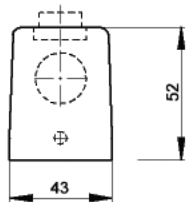

SIDE ENTRY



All dimensions are in mm.

Specifications: DIN 43652
Temperature Range: -40°C to +125°C

Protection class: NEMA 4, NEMA 12, IP65
Material: Aluminum alloy, powder coated

Position of Cable Entry	Size of Entry			Part Numbers			Complete your installation with a SKINTOP®, Pg 352			
	PG	NPT	Metric	PG	NPT	Metric	PG- Nylon	PG- Metal	Metric- Nylon	Metric- Metal
Top Entry	16	1/2"	20	10040900	100409NP	19040900	53015140	52015740	53111020	53112020
	21	3/4"	25	10040700	100407NP	19040700	53015150	52015750	53111030	53112030
Side Entry	16	1/2"	20	10042900	100429NP	19042900	53015140	52015740	53111020	53112020
	21	3/4"	25	10042800	100428NP	19042800	53015150	52015750	53111030	53112030

Top Entry metric hoods do not come with a neck.

HIGH PROFILE HOODS

TOP ENTRY

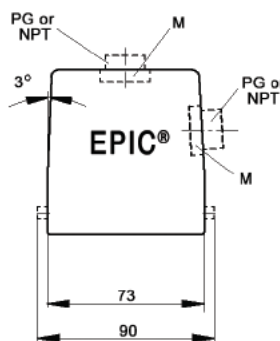
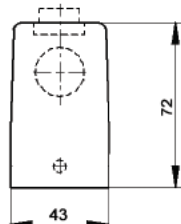

SIDE ENTRY



All dimensions are in mm.

Specifications: DIN 43652
Temperature Range: -40°C to +125°C

Protection class: NEMA 4, NEMA 12, IP65
Material: Aluminum alloy, powder coated

Position of Cable Entry	Size of Entry			Part Numbers			Complete your installation with a SKINTOP®, Pg 352			
	PG	NPT	Metric	PG	NPT	Metric	PG- Nylon	PG- Metal	Metric- Nylon	Metric- Metal
Top Entry	21	3/4"	25	70044200	700442NP	79044200	53015150	52015750	53111030	53112030
	29	1"	32	70044400	700444NP	79044400	53015160	52015760	53111040	53112040
Side Entry	21	3/4"	25	70054200	700542NP	79054200	53015150	52015750	53111030	53112030
	29	1"	32	70054400	700544NP	79054400	53015160	52015760	53111040	53112040

High Profile Metric hoods do not come with a neck.

EPIC® Rectangular Connectors



HBE 10 Housings: Single Lever on Base

PANEL MOUNT BASES

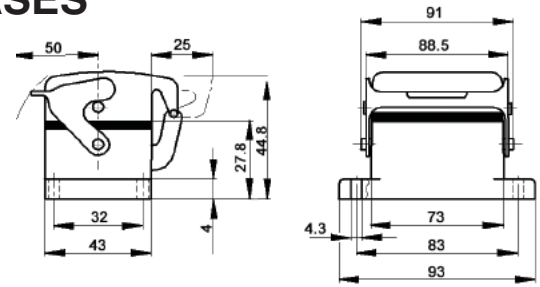

Specifications: DIN 43652
Temperature Range: -40°C to +125°C
Protection class: NEMA 4, NEMA 12, IP65
Material: Aluminum alloy, powder coated

Description	Part Numbers
Panel Mount without Dust Cover	10032900
Panel Mount with Dust Cover	10033900

All dimensions are in mm.

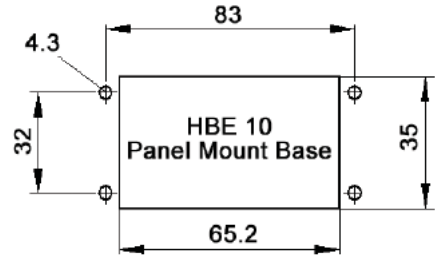

SURFACE MOUNT BASES

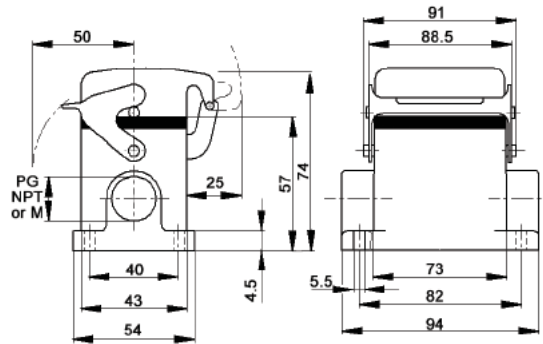

All dimensions are in mm.



Specifications: DIN 43652
Temperature Range: -40°C to +125°C

Protection class: NEMA 4, NEMA 12, IP65
Material: Aluminum alloy, powder coated

# of Entries	Size of Entry			Part Numbers			Complete your installation with a SKINTOP®, Pg 352			
	PG	NPT	Metric	PG	NPT	Metric	PG- Nylon	PG- Metal	Metric- Nylon	Metal
2 Entries	16	1/2"	20	10035900	100359NP	19035900	53015140	52015740	53111020	53112020
1 Entry	16	1/2"	20	10034900	100349NP	19034900	53015140	52015740	53111020	53112020
	21	3/4"	25	10034700	100347NP	19034700	53015150	52015750	53111030	53112030
2 Entries w/ dust cover	16	1/2"	20	10038900	100389NP	19038900	53015140	52015740	53111020	53112020
1 Entry with dust cover	16	1/2"	20	10036900	100369NP	19036900	53015140	52015740	53111020	53112020

DUST COVERS WITH ATTACHMENT STRING



Material: Thermoplastic Resin

Temperature: -40°C to 125°C

	Part #
Dust cover with single lever for HBE 10 Hoods	10048600
Dust cover with single lever bolts for HBE 10 Panel Mount or Surface Mount Base/ Cable Coupler Hood	10048700

EPIC® Rectangular Connectors



HBE 16 Housings: Single Lever on Base

HOODS

TOP ENTRY

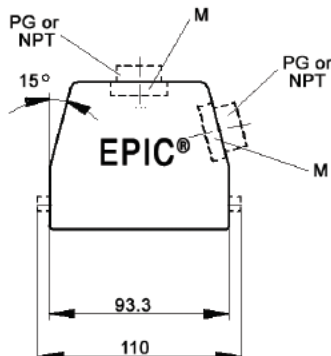
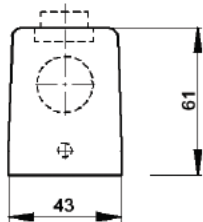

SIDE ENTRY



All dimensions are in mm.

Specifications: DIN 43652
Temperature Range: -40°C to +125°C

Protection class: NEMA 4, NEMA 12, IP65
Material: Aluminum alloy, powder coated

Position of Cable Entry	Size of Entry			Part Numbers			Complete your installation with a SKINTOP®, Pg 352			
	PG	NPT	Metric	PG	NPT	Metric	PG- Nylon	PG- Metal	Metric- Nylon	Metric- Metal
Top Entry	21	3/4"	25	10080900	100809NP	19080900	53015150	52015750	53111030	53112030
Side Entry	21	3/4"	25	10082900	100829NP	19082900	53015150	52015750	53111030	53112030
	29	1"	32	10092900	100929NP	19092900	53015160	52015760	53111040	53112040

Top Entry Metric hoods do not come with a neck.

HIGH PROFILE HOODS

TOP ENTRY

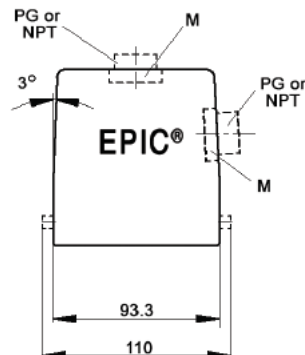
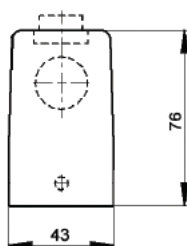

SIDE ENTRY



All dimensions are in mm.

Specifications: DIN 43652
Temperature Range: -40°C to +125°C

Protection class: NEMA 4, NEMA 12, IP65
Material: Aluminum alloy, powder coated

Position of Cable Entry	Size of Entry			Part Numbers			Complete your installation with a SKINTOP®, Pg 352			
	PG	NPT	Metric	PG	NPT	Metric	PG- Nylon	PG- Metal	Metric- Nylon	Metric- Metric
Top Entry	21	3/4"	25	70094200	700942NP	79094200	53015150	52015750	53111030	53112030
	29	1"	32	70094400	700944NP	79099400	53015160	52015760	53111040	53112040
	-	-	40	-	-	79094600	-	-	53111050	53112050
Side Entry	21	3/4"	25	70104200	701042NP	79104200	53015150	52015750	53111030	53112030
	29	1"	32	70104400	701044NP	79104400	53015160	52015760	53111040	53112040
	-	-	40	-	-	79104800	-	-	53111050	53112050

High Profile Metric hoods do not come with a neck.

EPIC® Rectangular Connectors



HBE 16 Housings: Single Lever on Base

PANEL MOUNT BASES

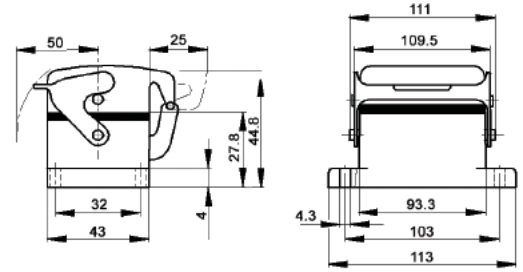

Specifications: DIN 43652
Temperature Range: -40°C to +125°C
Protection class: NEMA 4, NEMA 12, IP65
Material: Aluminum alloy, powder coated



Description	Part Numbers
Panel Mount without Dust Cover	10072900
Panel Mount with Dust Cover	10073900

All dimensions are in mm.

SURFACE MOUNT BASES

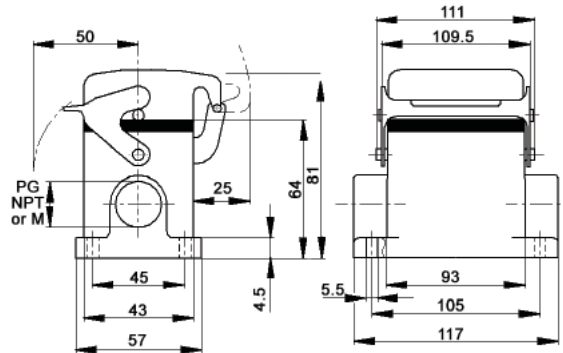

All dimensions are in mm.

Specifications: DIN 43652
Temperature Range: -40°C to +125°C

Protection class: NEMA 4, NEMA 12, IP65
Material: Aluminum alloy, powder coated

# of Entries	Size of Entry			Part Numbers			Complete your installation with a SKINTOP®, Pg 352			
	PG	NPT	Metric	PG	NPT	Metric	PG- Nylon	PG- Metal	Metric- Nylon	Metric- Metal
2 Entries	21	3/4"	25	10075900	100759NP	19075900	53015150	52015750	53111030	53112030
1 Entry	21	3/4"	25	10074900	100749NP	19074900	53015150	52015750	53111030	53112030
2 Entries w/ dust cover	21	3/4"	25	10078900	100789NP	19078900	53015150	52015750	53111030	53112030
1 Entry with dust cover	21	3/4"	25	10076900	100769NP	19076900	53015150	52015750	53111030	53112030

DUST COVERS WITH ATTACHMENT STRING



Material: Thermoplastic Resin

Temperature: -40°C to 125°C

	Part #
Dust cover with single lever for HBE 16 Hoods	10088600
Dust cover with single lever bolts for HBE 16 Panel Mount or Surface Mount Base/ Cable Coupler Hood	10088700

EPIC® Rectangular Connectors



HBE 16 Housings: Double Levers on Base

HOODS

TOP ENTRY

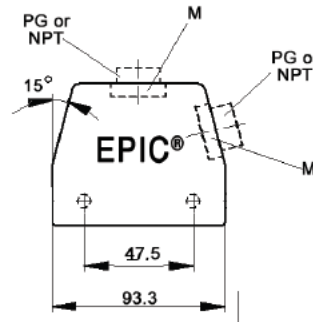
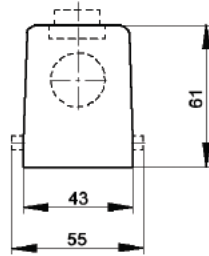

SIDE ENTRY



All dimensions are in mm.

Specifications: DIN 43652
Temperature Range: -40°C to +125°C

Protection class: NEMA 4, NEMA 12, IP65
Material: Aluminum alloy, powder coated

Position of Cable Entry	Size of Entry			Part Numbers			Complete your installation with a SKINTOP®, Pg 352			
	PG	NPT	Metric	PG	NPT	Metric	PG- Nylon	PG- Metal	Metric- Nylon	Metric- Metal
Top Entry	21	3/4"	25	100800C0	100800NP	19080000	53015150	52015750	53111030	53112030
	29	1"	32	100900C0	100900NP	19090000	53015160	52015760	53111040	53112040
Side Entry	21	3/4"	25	100820C0	100820NP	19082000	53015150	52015750	53111030	53112030
	29	1"	32	100920C0	100920NP	19092000	53015160	52015760	53111040	53112040

Top Entry metric hoods do not come with a neck.

HIGH PROFILE HOODS

TOP ENTRY

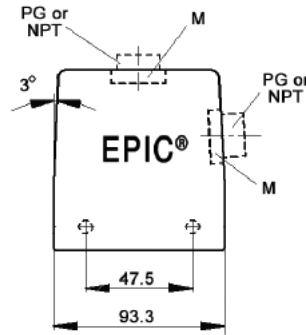
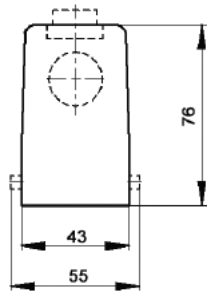

SIDE ENTRY



All dimensions are in mm.

Specifications: DIN 43652
Temperature Range: -40°C to +125°C

Protection class: NEMA 4, NEMA 12, IP65
Material: Aluminum alloy, powder coated

Position of Cable Entry	Size of Entry			Part Numbers			Complete your installation with a SKINTOP®, Pg 352			
	PG	NPT	Metric	PG	NPT	Metric	PG- Nylon	PG- Metal	Metric- Nylon	Metric- Metal
Top Entry	21	3/4"	25	701002C0	701002NP	79100200	53015150	52015750	53111030	53112030
	29	1"	32	701004C0	701004NP	79100400	53015160	52015760	53111040	53112040
	-	-	40	-	-	79100800	-	-	53111050	53112050
Side Entry	21	3/4"	25	701022C0	701022NP	79102200	53015150	52015750	53111030	53112030
	29	1"	32	701024C0	701024NP	79102400	53015160	52015760	53111040	53112040
	-	-	40	-	-	79102800	-	-	53111050	53112050

High Profile Metric hoods do not come with a neck.

EPIC® Rectangular Connectors



HBE 16 Housings: Double Levers on Base

PANEL MOUNT BASES

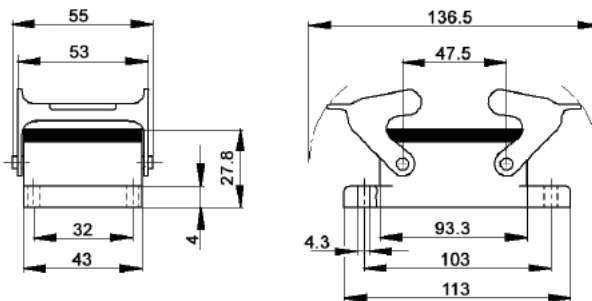

All dimensions are in mm.

Specifications: DIN 43652
Temperature Range: -40°C to +125°C
Protection class: NEMA 4, NEMA 12, IP65
Material: Aluminum alloy, powder coated

Description	Part Numbers
Panel Mount without Dust Cover	100720C0

SURFACE MOUNT BASES

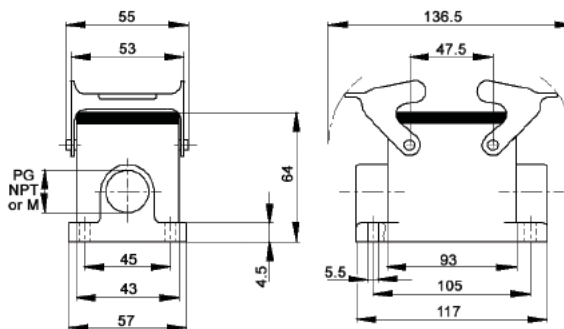

All dimensions are in mm.

Specifications: DIN 43652
Temperature Range: -40°C to +125°C

Protection class: NEMA 4, NEMA 12, IP65
Material: Aluminum alloy, powder coated

# of Entries	Size of Entry			Part Numbers			Complete your installation with a SKINTOP®, Pg 352			
	PG	NPT	Metric	PG	NPT	Metric	PG- Nylon	PG- Metal	Metric- Nylon	Metric- Metal
2 Entries	21	3/4"	25	100750C0	100750NP	19075000	53015150	52015750	53111030	53112030
1 Entry	21	3/4"	25	100740C0	100740NP	19074000	53015150	52015750	53111040	53112030

DUST COVERS WITH ATTACHMENT STRING



Material: Thermoplastic Resin **Temperature:** -40°C to +125°C

	Part #
Dust cover with double levers and gasket for HBE 16 Hoods	10088500
Dust cover with double lever bolts for HBE 16 Panel Mount or Surface Mount Base/ Cable Coupler Hood	10087000