

Time Delay Relays – Application Data

Definition:

Time Delay is defined as the controlled period between the functioning of two events. A Time Delay relay is a combination of an electromechanical output relay and a control circuit. The control circuit is comprised of solid state components and timing circuits that control operation of the relay and timing range. Typical time delay functions include On-Delay, Repeat cycle (starting off), Interval, Off-Delay, Retriggerable One Shot, Repeat cycle (starting on), Pulse Generator, One Shot, On/Off Delay, and Memory Latch. Each function is explained in the table below. Time delay relays have a broad choice of timing ranges from less than one second to many days. There are many choices of timing adjustments from calibrated external knobs, DIP switches, thumbwheel switches, or recessed potentiometer. The output contacts on the electromechanical output relay are direct wired to the output terminals. The contact load ratings are specified for each specific type of time delay relay.

Understanding the differences between all the functions available in time delay relays can sometimes be a daunting task. When designing circuits using time delay relays questions such as:

“What initiates a time delay relay?”

“Does the timing start with the application or release of voltage?”

“When does the output relay come on?”

must be asked.

Time delay relays are simply control relays with a time delay built in. Their purpose is to control an event based on time. The difference between relays and time delay relays is when the output contacts open & close: on a control relay, it happens when voltage is applied and removed from the coil; on time delay relays, the contacts will open or close before or after a pre-selected, timed interval.

Typically, time delay relays are initiated or triggered by one of two methods:

- application of input voltage (On Delay, Interval On, Flasher, Repeat Cycle, Delayed Interval & Interval/Flasher).
- opening or closing of a trigger signal (Off Delay, Single Shot & Watchdog).

These trigger signals can be one of two designs:

- a control switch (dry contact), i.e., limit switch, push button, float switch, etc.
- voltage (commonly known as a power trigger).

To help understand, some definitions are important:



Input Voltage: Control voltage applied to the input terminals (see wiring diagrams below). Depending on the function, input voltage will either initiate the unit or make it ready to initiate when a trigger signal is applied.

Trigger Signal: On certain timing functions, a trigger signal is used to initiate the unit after input voltage has been applied. As noted above, this trigger signal can either be a control switch (dry contact switch) or a power trigger (voltage).

Output (Load): Every time delay relay has an internal relay (usually mechanical) with contacts that open & close to control the load. They are represented by the dotted lines in the wiring diagrams. Note that the user must provide the voltage to power the load being switched by the output contacts of the time delay relay.

The following tables contain both written and visual descriptions on how the common timing functions operate. A Timing Chart shows the relationship between Input Voltage, Trigger Signal (if present) and Output Contacts.

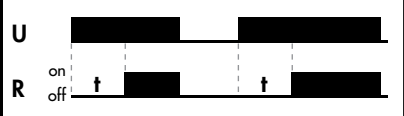
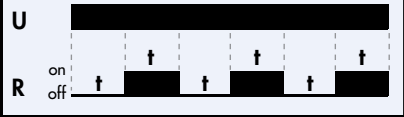
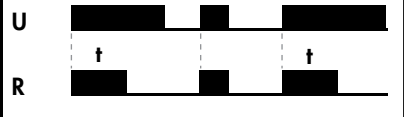
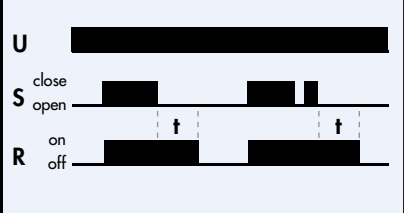
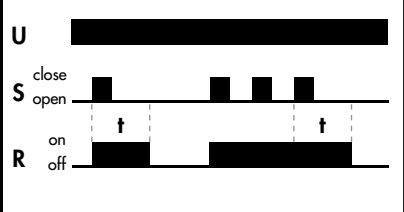
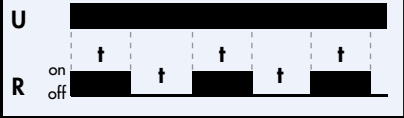
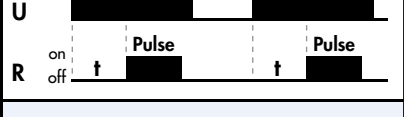
FUNCTION DEFINITION TABLE

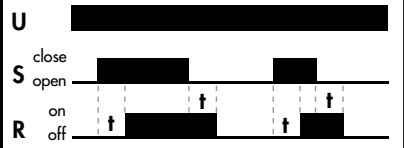
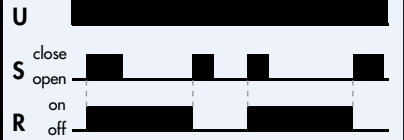
Function	Operation	Timing Chart
A. ON DELAY Power On	When the input voltage U is applied, timing delay t begins. Relay contacts R change state after time delay is complete. Contacts R return to their shelf state when input voltage U is removed. Trigger switch is not used in this function.	
B. REPEAT CYCLE Starting Off	When input voltage U is applied, time delay t begins. When time delay t is complete, relay contacts R change state for time delay t . This cycle will repeat until input voltage U is removed. Trigger switch is not used in this function.	
C. INTERVAL Power On	When input voltage U is applied, relay contacts R change state immediately and timing cycle begins. When time delay is complete, contacts return to shelf state. When input voltage U is removed, contacts will also return to their shelf state. Trigger switch is not used in this function.	
D. OFF DELAY S Break	Input voltage U must be applied continuously. When trigger switch S is closed, relay contacts R change state. When trigger switch S is opened, delay t begins. When delay t is complete, contacts R return to their shelf state. If trigger switch S is closed before time delay t is complete, then time is reset. When trigger switch S is opened, the delay begins again, and relay contacts R remain in their energized state. If input voltage U is removed, relay contacts R return to their shelf state.	
E. RETRIGGERABLE ONE SHOT	Upon application of input voltage U , the relay is ready to accept trigger signal S . Upon application of the trigger signal S , the relay contacts R transfer and the preset time t begins. At the end of the preset time t , the relay contacts R return to their normal condition unless the trigger switch S is opened and closed prior to time out t (before preset time elapses). Continuous cycling of the trigger switch S at a rate faster than the preset time will cause the relay contacts R to remain closed. If input voltage U is removed, relay contacts R return to their shelf state.	
F. REPEAT CYCLE Starting On	When input voltage U is applied, relay contacts R change state immediately and time delay t begins. When time delay t is complete, contacts return to their shelf state for time delay t . This cycle will repeat until input voltage U is removed. Trigger switch is not used in this function.	
G. PULSE GENERATOR	Upon application of input voltage U , a single output pulse of 0.5 seconds is delivered to relay after time delay t . Power must be removed and reapplied to repeat pulse. Trigger switch is not used in this function.	
H. ONE SHOT	Upon application of input voltage U , the relay is ready to accept trigger signal S . Upon application of the trigger signal S , the relay contacts R transfer and the preset time t begins. During time-out, the trigger signal S is ignored. The relay resets by applying the trigger switch S when the relay is not energized.	
I. ON/OFF DELAY S Make/Break	Input voltage U must be applied continuously. When trigger switch S is closed, time delay t begins. When time delay t is complete, relay contacts R change state and remain transferred until trigger switch S is opened. If input voltage U is removed, relay contacts R return to their shelf state.	
J. MEMORY LATCH S Make	Input voltage U must be applied continuously. Output changes state with every trigger switch S closure. If input voltage U is removed, relay contacts R return to their shelf state.	

U = Input Voltage **S** = Trigger Switch **R** = Relay Contacts **t** = Time Delay

Advantages of the TDRSOX/SRX Time Delay Relays

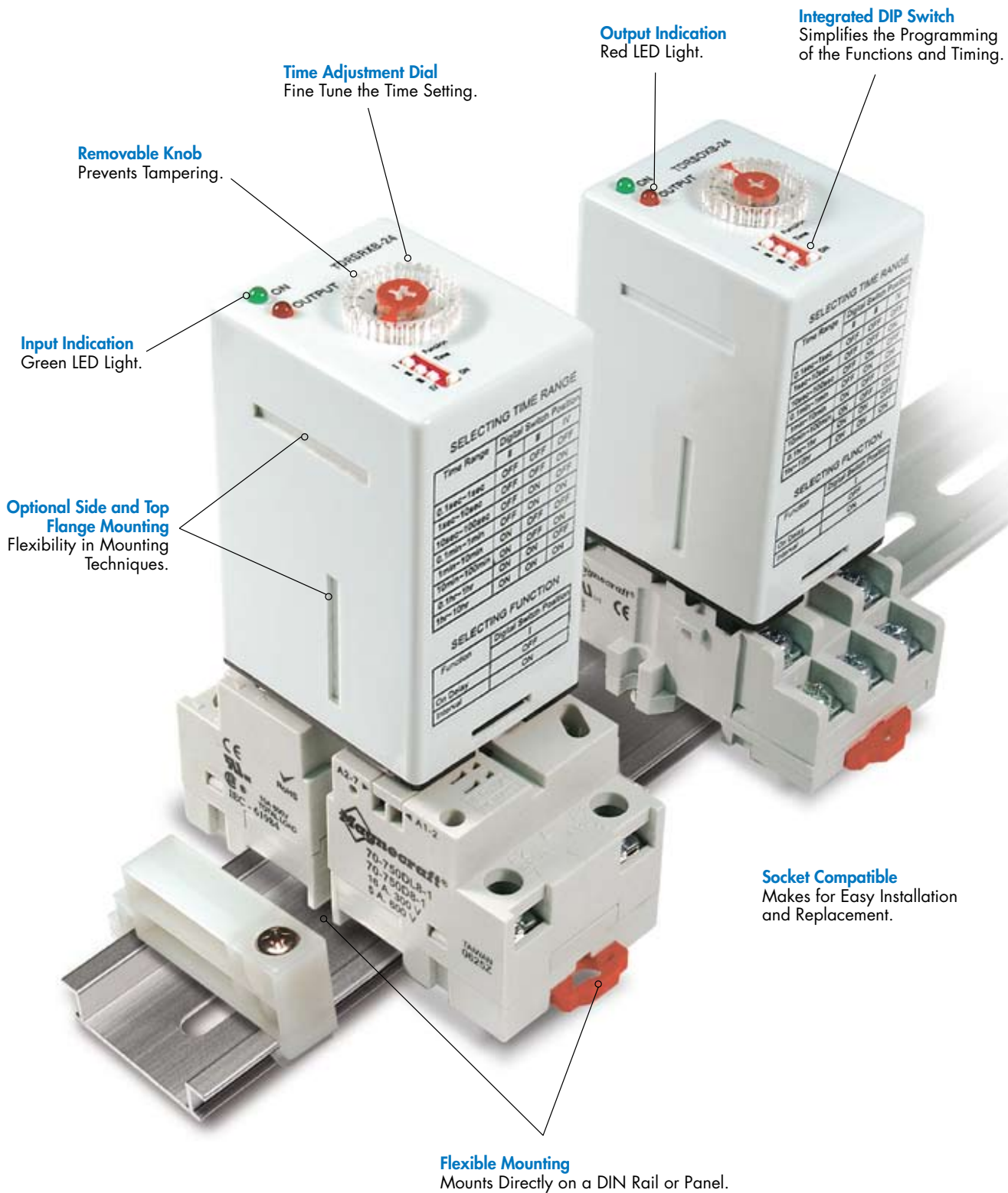

The Complete System Solution!



The TDRSOX/SRX series is a dual-function, dual-voltage time delay relay that offers a wide timing range. This cost sensitive timer features DIP switches that allow the user to set the function modes and choose between eight separate time scales. The knob on top is used for fine tuning the time setting. This dual adjustment design allows for supreme flexibility and timing accuracy. The dual LEDs allow the user to know when power is present at the coil and when the output is energized.

The SOX series features both On Delay and Interval functions, in contrast the SRX series has the capability of handling the Off Delay and Retriggerable One Shot functions. Please see the Application Data at the beginning of this section for a complete description of the above four functions. Combining all of this into one affordable package is the reason Magnecraft continues to be a leader in providing the most comprehensive line of control and timing relays.

- Offers a “one stop solution” for your power management system.
- Several configurations available to meet your individual needs.
- Switching capabilities up to 12 amps.
- The broad timing range meets most timing requirements.
- Dual voltage coils eliminate the need to specify AC or DC. (AC only for 240).
- The two LED status indicators; indicate status at a glance. The green LED is on when power is applied to the input terminals. The red LED blinks during timeout and is on when the output is energized.
- Integrated DIP switch simplifies the programming of the functions and timing.
- Color and appearance designed for high visibility in all environments.
- Engineering availability allows for customized control system solutions.

TDRSOX/SRX Time Delay Relays/DPDT 12 Amp Rating

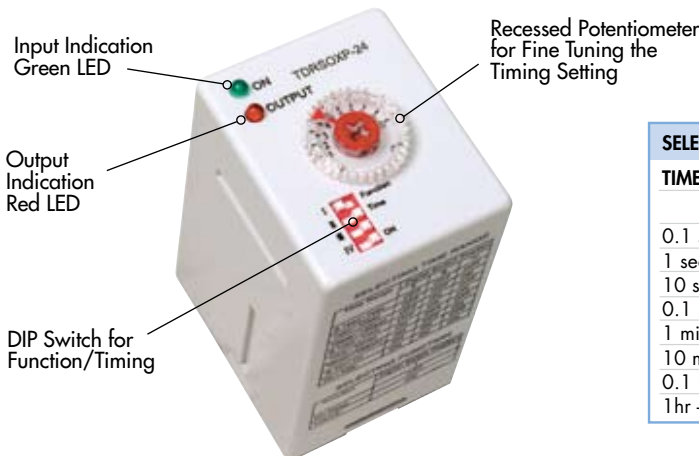

SELECTING TIME RANGES			
TIME RANGE	DIGITAL SWITCH POSITION		
	II	III	IV
0.1 sec - 1 sec	OFF	OFF	OFF
1 sec - 10 sec	OFF	OFF	ON
10 sec - 100 sec	OFF	ON	OFF
0.1 min - 1 min	OFF	ON	ON
1 min - 10 min	ON	OFF	OFF
10 min - 100 min	ON	OFF	ON
0.1 hr - 1 hr	ON	ON	OFF
1 hr - 10 hr	ON	ON	ON

General Specifications (@ 25°C) (UL 508)

Output Characteristics		Units	TDRSOX	TDRSRX
Number and type of Contacts			DPDT	DPDT
Contact Material			Silver Alloy	Silver Alloy
Current rating	@ 240 VAC, 24 VDC	A	12	12
Switching voltage		V	240 AC, 50/60 Hz	240 AC, 50/60 Hz
		V	30 DC	30 DC
		HP	1/3 @ 120VAC	1/3 @ 120VAC
		HP	1/2 @ 240 VAC	1/2 @ 240 VAC
		Pilot Duty	B300	B300
Minimum Switching Requirement		mA	100	100
Indication	LED		Red	Red
Input Characteristics				
Voltage Range		VAC / VDC	12, 24, 120	12, 24, 120
		VAC	240	240
Operating Range	% of Nominal		80% to 110%	80% to 110%
Maximum consumption		AC VA	5	5
		DC W	2.5	2.5
Indication	LED		Green	Green
Timing Characteristics				
Functions Available	(See page 5/3)		A, C	D, E
Time Scales			8	8
Time Ranges Available		sec	0.1...1	0.1...1
		sec	1...10	1...10
		sec	10...100	10...100
		min	0.1...1	0.1...1
		min	1...10	1...10
		min	10...100	10...100
		hr	0.1...1	0.1...1
		hr	1...10	1...10
Tolerance	Mechanical Setting	%	10	10
Repeatability	Constant Voltage and Temperature	%	1	1
Reset Time	Maximum	ms	150	150
Trigger Pulse Length	Minimum	ms	50	50
Performance Characteristics				
Electrical Life	Operations @ Rated Current (Resistive)		100,000	100,000
Mechanical Life	Unpowered		10,000,000	10,000,000
Dielectric strength	Input to Contacts	V	2500 AC	2500 AC
	Between Open Contacts	V	1000 AC	1000 AC
Environment				
Product certifications	Standard version		UR, UL	UR, UL
Ambient air temperature around the device	Storage	°C	-20...+85	-20...+85
	Operation	°C	-20...+55	-20...+55
Degree of protection			IP 40	IP 40
Weight		grams	85	85

SECTION 5

FUNCTION DEFINITIONS

See Section 5 p.3

SELECTING FUNCTION	
FUNCTION SOX	DIGITAL SWITCH POSITION
ON DELAY	OFF
INTERVAL	ON
FUNCTION SRX	
OFF DELAY	OFF
RETRIGGERABLE ONE SHOT	ON



TDRSOX/SRXB



TDRSOX/SRXP

Standard Part Numbers

BOLD-FACED PART NUMBERS ARE NORMALLY STOCKED

Part Number	Input Voltage	Timing Range	Contact Configuration	Rated Load Current
8 Pin Octal Base - On Delay/Interval				
TDRSOXP-12V	12 VAC/VDC	0.1s...10h	DPDT	12 Amps
TDRSOXP-24V	24 VAC/VDC	0.1s...10h	DPDT	12 Amps
TDRSOXP-120V	120 VAC/VDC	0.1s...10h	DPDT	12 Amps
TDRSOXP-240A	240 VAC	0.1s...10h	DPDT	12 Amps
11 Pin Octal Base - Off Delay/Retriggerable One Shot				
TDRSRXP-12V	12 VAC/VDC	0.1s...10h	DPDT	12 Amps
TDRSRXP-24V	24 VAC/VDC	0.1s...10h	DPDT	12 Amps
TDRSRXP-120V	120 VAC/VDC	0.1s...10h	DPDT	12 Amps
TDRSRXP-240A	240 VAC	0.1s...10h	DPDT	12 Amps
8 Blade Square Base - On Delay/Interval				
TDRSOXB-12V	12 VAC/VDC	0.1s...10h	DPDT	12 Amps
TDRSOXB-24V	24 VAC/VDC	0.1s...10h	DPDT	12 Amps
TDRSOXB-120V	120 VAC/VDC	0.1s...10h	DPDT	12 Amps
TDRSOXB-240A	240 VAC	0.1s...10h	DPDT	12 Amps
11 Blade Square Base - Off Delay/Retriggerable One Shot				
TDRSRXB-12V	12 VAC/VDC	0.1s...10h	DPDT	12 Amps
TDRSRXB-24V	24 VAC/VDC	0.1s...10h	DPDT	12 Amps
TDRSRXB-120V	120 VAC/VDC	0.1s...10h	DPDT	12 Amps
TDRSRXB-240A	240 VAC	0.1s...10h	DPDT	12 Amps

Part Number Builder

Series	Function	Terminal Style	Input Voltage
TDR = Time Delay Relay	SOX = On Delay/Interval	P = Pins Octal	12V = 12 VAC/VDC
	SRX = Off Delay/Retriggerable One Shot	B = Blade Square	24V = 24 VAC/VDC
			120V = 120 VAC/VDC
			240A = 240 VAC

WIRING DIAGRAMS

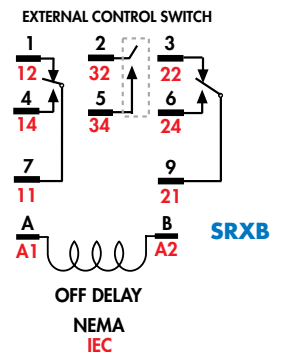
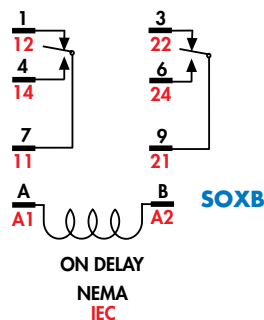
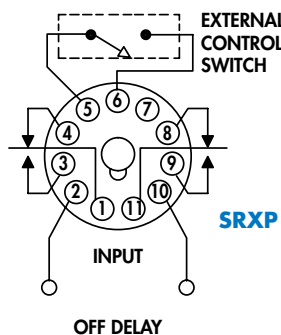
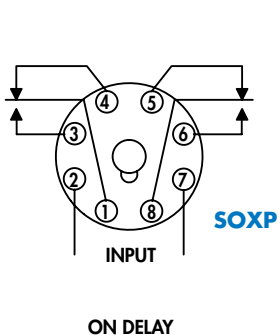

TDRSOX/SRX Time Delay Relays *continued*



UL Listed When Used With
Magnecraft Sockets.



UL Recognized
File No. E43641

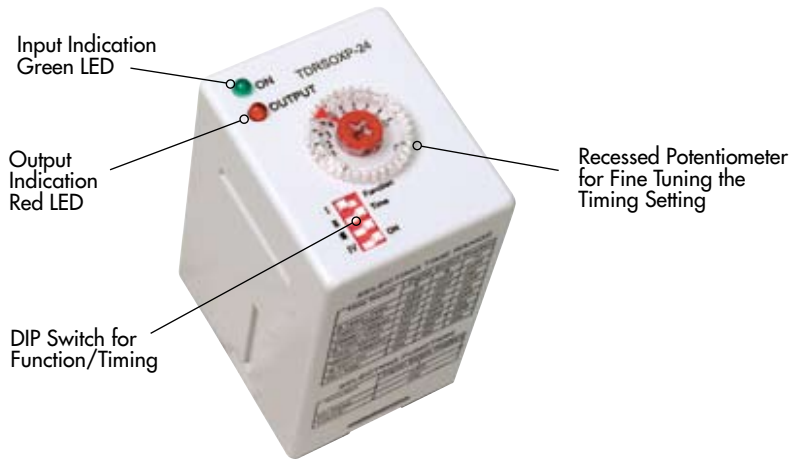

**NOTE: Terminal size is 0.187 x 0.020
(4.75 x 0.508)**

TDRSOX/SRXB

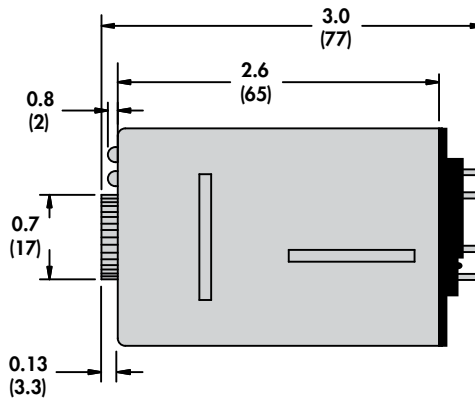
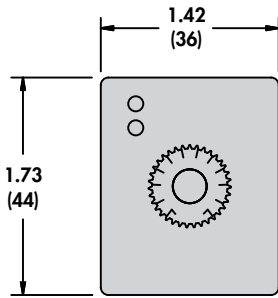

TDRSOX/SRXP

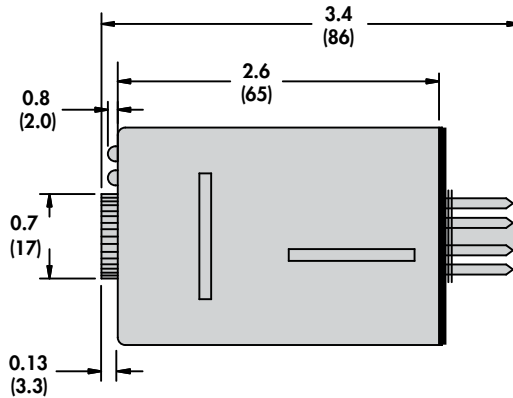

Relay Adapters



16-711C1
Section 3 p.14-16



16-711C4
Section 3 p.14-16



TDRSOX/SRXP



TDRSOX/SRXP

Other mating sockets see Section 2: 70-750E8-1, 70-750E11-1, 70-169-1, 70-170-1, 70-465-1, 70-464-1

