

DIN RAIL POWER SUPPLIES

(30-960 WATTS)

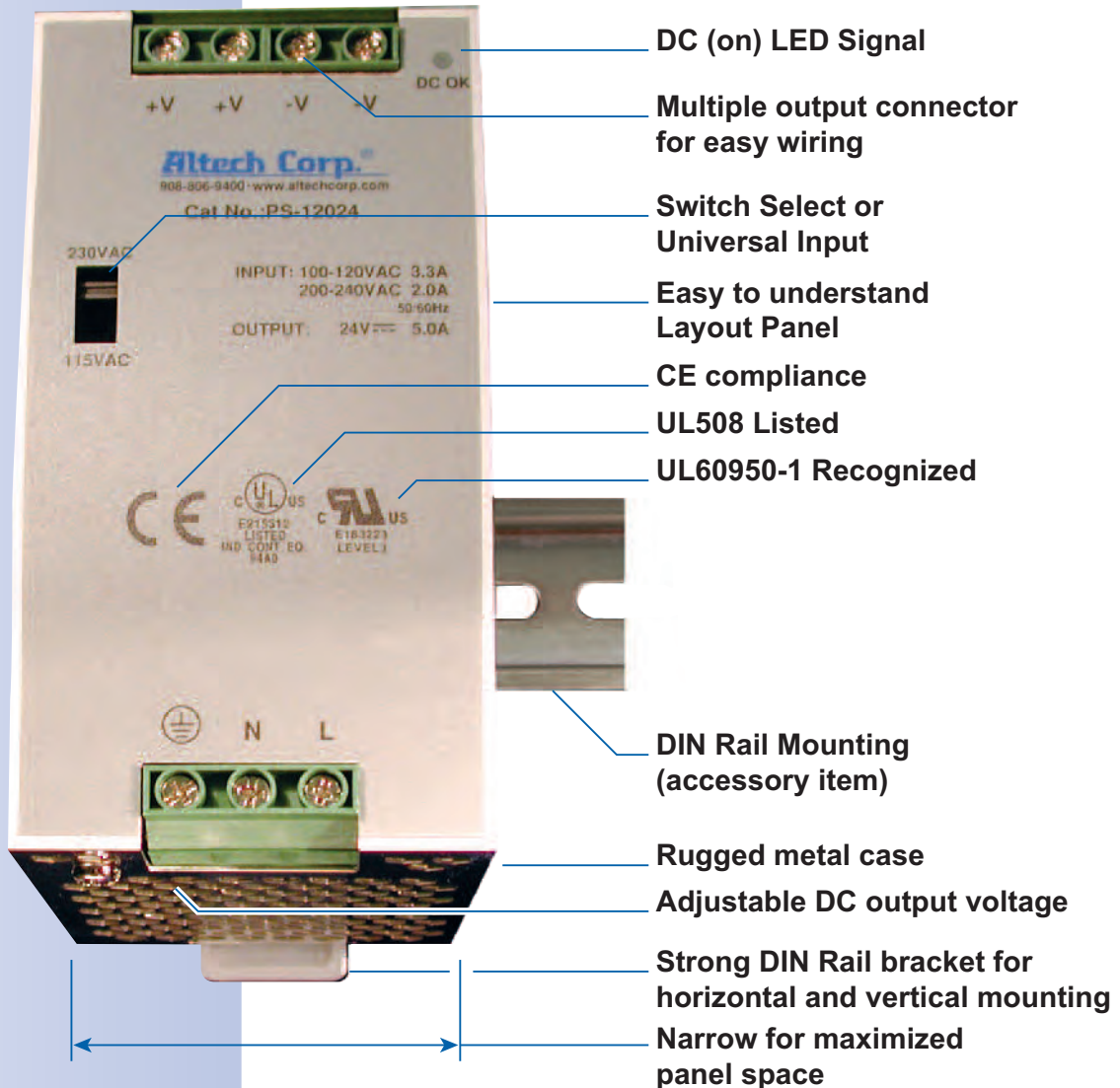

- DIN Rail Mount, 35 x 7.5 mm or 35 x 15 mm
- Wide Power Range (30W-960W)
- Wide Adjustment Range
- Rugged for Industrial Use
- High Efficiency
- Lightweight and Compact Design
- 3 year warranty
- Short Circuit Protection
- Overvoltage Protection
- Overload Protection
- Overtemperature Protection
- Cooling by free air convection
- Worldwide Approvals
- UL508 Listed and/or UL60950-1 Recognized



Altech Power SuppliesEasy to Use & Reliable!

Specifications

Input

- Input Voltage
 - 90-264V AC for the single phase
 - 340-550V AC for the three phase
- Input Frequency: 47-63 Hz
- Input Current: 0.6 A to 8A
- Inrush Current: cold start 60 A max
- Power Factor: All units are EN61000-3-2 compliant

General

- Efficiency: 72-92% (see data sheets)
- Isolation: 3000V AC Input to Output
1500V AC Input to Ground
500V AC Output to Ground

Environmental

Power supplies can run at 100% capacity inside the panel, there is no need for oversizing. See derating curves for more information.

- Operating Temperature:
-20 to +60°C (-4° to +140°F)
- Operating Humidity:
90% RH, non-condensing
- Storage Temperature:
-20 °C to +85 °C (-4° to +185°F)
- Vibration: 2 G, 10 Hz to 500 kHz,
10 min/cycle for 60 minutes each axis



Output

- Output Voltage: 5V; 12V; 15V; 24V; 48V
- Output Voltage Adjustment Range: $\pm 10\%$
- Initial Set Accuracy: $\pm 2\%$ max
- Ripple & Noise: See data sheet
- Over-voltage Protection: 115-135%
- Overload Protection: 105-150%,
constant current with auto recovery

EMC & Safety

- Emissions: EN55022/55011, Class B
- EN61000-3-2, -3
- Voltage Flicker: EN61000-3-3
- ESD Immunity: EN61000-4-2, level 3
- Radiated Immunity: EN61000-4-3, 10 V/m
- EFT/Burst: EN61000-4-4, level 3
- Surge: EN61000-4-5, level 3
- Conducted Immunity:
EN61000-4-6, 10 V rms,
- Safety Approvals:
EN60950
UL508
UL60950
CE marked
- Military Standard
MIL-HDBK-217F



20-100W Single Phase Slimline Power Supplies



Key Features

- Universal AC Input / Full Range
- NEC class 2 / LPS compliant (Only selected models; see data sheet at altechcorp.com)
- LED indicator for power on
- 100% full load burn-in test
- 3 year warranty
- Input voltage range:
 - 85-264V AC
 - 120-370V DC
- AC inrush current (*typical*):
 - Cold start: 20A at 115V AC, 40A at 230V DC
- DC adjustment range (*typical*):
 - ±10% rated output voltage
- Overload protection (*typical*):
 - 105%-160% constant current limiting, auto-recovery
- Over-voltage protection (*typical*):
 - 115%-135% rated output voltage
- Setup, rise, time (*typical*):
 - 500ms, 30ms/230V AC
 - 10000ms, 30ms/115V AC, at full load
- Withstand voltage:
 - I/P-O/P: 3KV AC, I/P-FG: 1.5KV AC, O/P-FG: 0.5KV AC,
- Working temperature:
 - 20 to +70°C (-4° to +158°F), refer to output derating curve
- Safety standards:
 - UL508, EN60950-1*
- EMC standards:
 - EN55022 class B,
 - EN61000-4-2,3,4,5,6,8,11,
 - ENV50204, EN55024, EN61000-6-1,
 - EN61204-3 Light Industry Level**, criteria A
- Military Standard
 - MIL-HDBK-217F

* Except PS-S20xx

** Heavy for PS-S40xx and PS-S60xx



20W Single Output Industrial DIN Rail Power Supply

| Cat. No. | Output V DC | A | Tol. % | Ripple & Noise | Efficiency |
|----------|----------------|-------|-----------|-------------------|------------|
| PS-S2005 | 5V DC | 3A | ±2% | 80 mVp-p | 76% |
| PS-S2012 | 12V DC | 1.67A | ±1% | 120 mVp-p | 80% |
| PS-S2015 | 15V DC | 1.34A | ±1% | 120 mVp-p | 81% |
| PS-S2024 | 24V DC | 1A | ±1% | 150 mVp-p | 84% |

Universal Input: 85-264V AC, 120-370V DC full range;
0.55A @ 115V AC; 0.35A @ 230V AC
Connection: Input - 3 poles, Output - 2 poles screw terminal
+ DC OK active signal
Size (WxHxD): 22.5x90x100mm (0.89x3.54x3.94 inches)
Packaging: 1/box; 0.48lbs / 0.19Kg



40W Single Output Industrial DIN Rail Power Supply

| Cat. No. | Output V DC | A | Tol. % | Ripple & Noise | Efficiency |
|----------|----------------|-------|-----------|-------------------|------------|
| PS-S4005 | 5V DC | 6A | ±2% | 80 mVp-p | 79% |
| PS-S4012 | 12V DC | 3.33A | ±1% | 120 mVp-p | 86% |
| PS-S4024 | 24V DC | 1.7A | ±1% | 150 mVp-p | 88% |
| PS-S4048 | 48V DC | 0.83A | ±1% | 200 mVp-p | 88% |

Universal Input: 85-264V AC, 120-370V DC full range;
1.1A @ 115V AC, 0.7A @ 230V AC
Connection: Input - 3 poles, Output - 4 poles screw terminal
+ DC OK relay contact
Size (WxHxD): 40x90x100mm (1.57x3.54x3.94 inches)
Packaging: 1/box; 0.66lbs / 0.3Kg



60W Single Output Industrial DIN Rail Power Supply

| Cat. No. | Output V DC | A | Tol. % | Ripple & Noise | Efficiency |
|----------|----------------|-------|-----------|-------------------|------------|
| PS-S6005 | 5V DC | 10A | ±2% | 80 mVp-p | 79% |
| PS-S6012 | 12V DC | 5A | ±1% | 120 mVp-p | 86% |
| PS-S6024 | 24V DC | 2.5A | ±1% | 150 mVp-p | 88% |
| PS-S6048 | 48V DC | 1.25A | ±1% | 200 mVp-p | 89% |

Universal Input: 85-264V AC, 120-370V DC full range;
1.8A @ 115V AC, 1A @ 230V AC
Connection: Input - 3 poles, Output - 4 poles screw terminal
+ DC OK relay contact
Size (WxHxD): 40x90x100mm (1.57x3.54x3.94 inches)
Packaging: 1/box; 0.73lbs / 0.33Kg



100W Single Output Industrial DIN Rail Power Supply

| Cat. No. | Output V DC | A | Tol. % | Ripple & Noise | Efficiency |
|-----------|----------------|----|-----------|-------------------|------------|
| PS-S10012 | 12V DC | 8A | ±1% | 120 mVp-p | 87% |
| PS-S10024 | 24V DC | 4A | ±1% | 150 mVp-p | 88% |
| PS-S10048 | 48V DC | 2A | ±1% | 200 mVp-p | 87% |

Connection: Input - 2 poles, Output - 4 poles screw terminal
Size (WxHxD): 55x90x100mm (2.17x3.54x3.94 inches)
Packaging: 1/box; 0.73lbs / 0.33Kg

PS-S20 Series

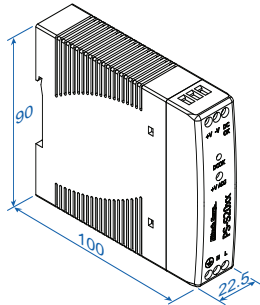

Terminal Pin. No Assign. (TB1)

| Pin No. | Assignment |
|---------|------------|
| 1 | FG Ⓢ |
| 2 | AC/N |
| 3 | AC/L |

Terminal Pin. No Assign. (TB2)

| Pin No. | Assignment |
|---------|--------------|
| 1 | DC OUTPUT +V |
| 2 | DC OUTPUT -V |
| 3 | DC OK SIGNAL |

Output Derating

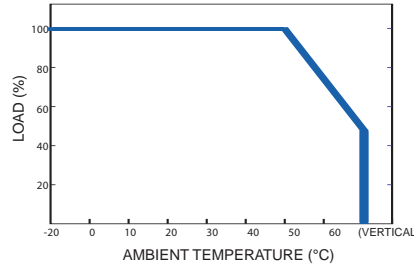

Output Derating Curve vs. Input Voltage

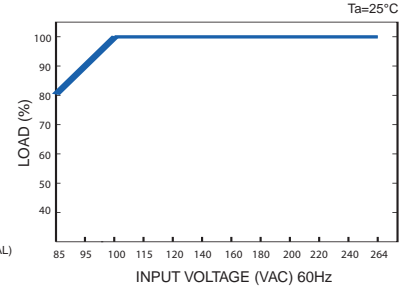

PS-S40 Series

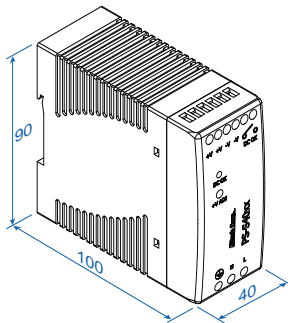

Terminal Pin. No Assign. (TB1)

| Pin No. | Assignment |
|---------|------------|
| 1 | FG Ⓢ |
| 2 | AC/N |
| 3 | AC/L |

Terminal Pin. No Assign. (TB2)

| Pin No. | Assignment |
|---------|---------------------|
| 1,2 | DC OUTPUT +V |
| 3,4 | DC OUTPUT -V |
| 5,6 | DC OK RELAY CONTACT |

Output Derating

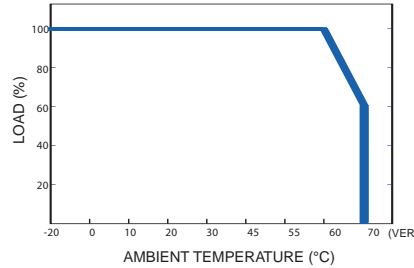

Output Derating Curve vs. Input Voltage

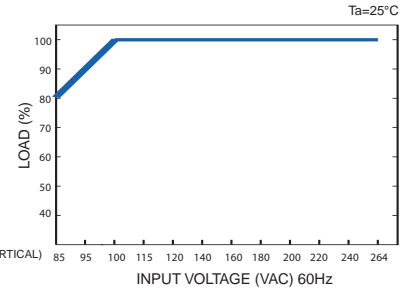

PS-S60 Series

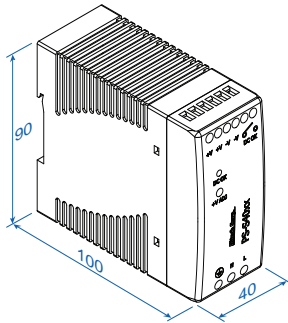

Terminal Pin. No Assign. (TB1)

| Pin No. | Assignment |
|---------|------------|
| 1 | FG Ⓢ |
| 2 | AC/N |
| 3 | AC/L |

Terminal Pin. No Assign. (TB2)

| Pin No. | Assignment |
|---------|---------------------|
| 1,2 | DC OUTPUT +V |
| 3,4 | DC OUTPUT -V |
| 5,6 | DC OK RELAY CONTACT |

Output Derating

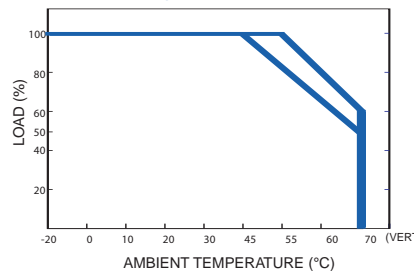

Output Derating Curve vs. Input Voltage

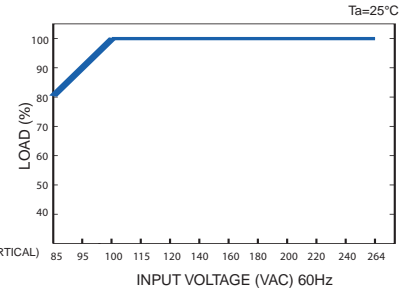

PS-S100 Series

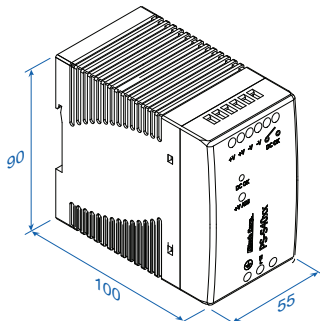

Terminal Pin. No Assign. (TB1)

| Pin No. | Assignment |
|---------|------------|
| 1 | FG Ⓢ |
| 2 | AC/N |
| 3 | AC/L |

Terminal Pin. No Assign. (TB2)

| Pin No. | Assignment |
|---------|---------------------|
| 1,2 | DC OUTPUT +V |
| 3,4 | DC OUTPUT -V |
| 5,6 | DC OK RELAY CONTACT |

Note: All dimensions are in millimeters, to convert to inches multiply by 0.03937.