

Back

- o Flat Cable Connectors SEK
- o *har-mik*®
- o D-Sub
- o InduCom





➤ Applications

## Product details

### 09 20 004 2711 Female insert, Han 4 A

Series	Han A®
Number of contacts	4 poles + PE
Size of hood/ housing	Han® 3 A
Termination	Screw termination
Insert material	Standard material
Contacts	Inclusive
Electrical data	10 A 230/400 V 4 kV 3
RoHS compliant	Yes

#### Available Downloads



Title	Format	
Data sheet	PDF	 download
CAD data 2D	DXF	 download
CAD data 3D	IGES	 download
CAD data 3D	STEP	 download

Inquiry

Alle Rechte vorbehalten/ All rights reserved

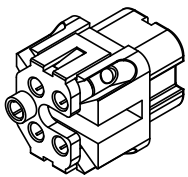
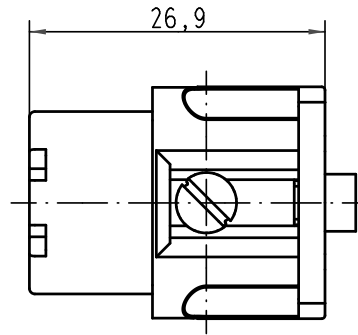
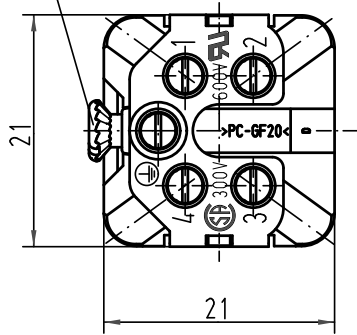
Senkschraube M3x6-4.8  
lose beigelegt  
Countersunk screw M3x6-4.8  
loose enclosed



 All Dimensions in mm Original Size DIN A 4			Techn. Character.			Nicht tolerierte Masse/ Free size tolerances	
			Det.	Name	Masstab/Scale		
413664	14.02.08	Ru I I	27.01.93	WILD	2:1	Han 4A-F	
410228	18.10.02	Loe.		HERB		Buchseneinsatz/female insert	
27851	28.06.00	Pae					
25852	16.04.99	PL				TB 09 20 004 2711	
Mod.	Dat.	Name	HARTING Electric GmbH & Co. KG D-32339 Espelkamp				Blatt/ page

Sub. /