

Extended/Direct Handle Motor Disconnect Switch

The KU/VKA...N series can be used with extended and direct handles (see page 8-9 for details).

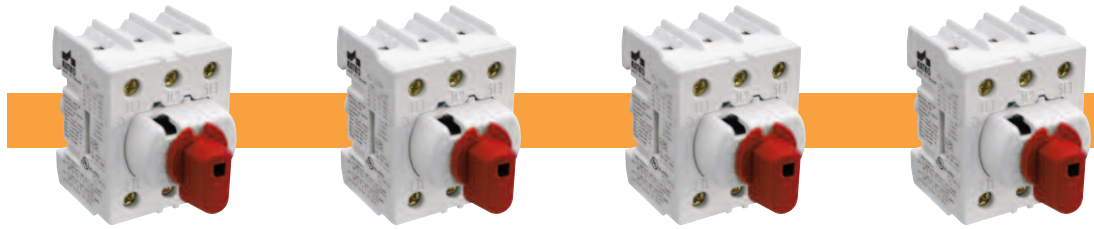

Catalog Number	KU316N	KU325N	KU340N	KU363N
No. of Poles	3 (4 pole - KU416N)	3 (4 pole - KU425N)	3 (4 pole - KU440N)	3 (4 pole - KU463N)
General Purpose Current	16A	25A	40A	60A
Maximum Voltage	600V AC	600V AC	600V AC	600V AC
Motor FLA @ 480V AC	14A	17.5A	28A	34A
Motor FLA @ 600V AC	9A	11A	18A	27A

Horsepower Rating /HP	1 Phase		3 Phase		1 Phase		3 Phase		1 Phase		3 Phase	
	110-120V AC	3/4	1 1/2	1	2	2	3	7.5	5	3	5	10
200V AC	2	3	2	5	3	7.5	5	5	5	10		
208V AC	2	3	2	5	3	7.5	5	5	5	10		
220-240V AC	2	3	3	7.5	5	10	5	5	5	10		
265V AC	2	3	3	7.5	5	10	5	5	5	10		
277V AC	2	3	3	7.5	5	10	7.5	5	5	10		
380-415V AC	3	7.5	5	10	7.5	15	10	10	10	20		
440-480V AC	5	10	7.5	15	10	20	15	15	15	25		
550-600V AC	3	7.5	5	10	7.5	15	15	15	15	25		

Short Circuit Withstand Rating at 600 V with Max. Fuse Size/Class:	10kA	10kA	10kA	10kA
K5	50A	50A	50A	60A
RK5	50A	50A	50A	60A (80A@480V AC)
RK1	80A	80A	80A	100A
J	80A	80A	80A	100A

Terminal Size Acceptability (Cu Conductors only, 75°C)	14-8AWG	14-8AWG	14-8AWG	12-4AWG
Terminal Torque	16 lb. in.	16 lb. in.	16 lb. in.	16 lb. in.

Dimensions

(to convert to inches multiply by 0.03937)



4 Pole

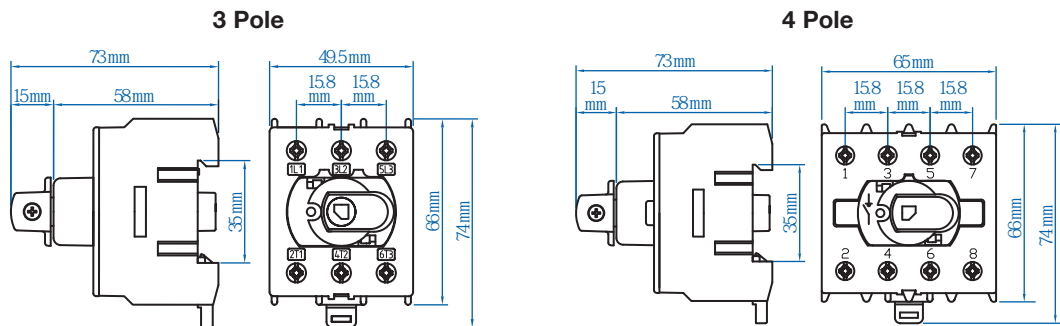

Weight	0.19Kg (0.419lb.) (3 pole) 0.23Kg (0.507lb.) (4 pole)	0.172Kg (0.379lb.) (3 pole) 0.215Kg (0.474lb.) (4 pole)	0.172Kg (0.379lb.) (3 pole) 0.215Kg (0.474lb.) (4 pole)	0.200Kg (0.441lb.) (3 pole) 0.245Kg (0.540lb.) (4 pole)
--------	--	--	--	--

Suitable Accessories

Extended Handle Version/ Door Interlock Mechanism

Shaft	L(1,2,3)00AD11-ST	L(1,2,3)00AD11-ST	L(1,2,3)00AD11-ST	L(1,2,3)00AD11-ST
Handles	LK10 (Y/R) UL, LK11 (Y/R) U	LK10 (Y/R) UL, LK11 (Y/R) U	LK10 (Y/R) UL, LK11 (Y/R) U	LK10 (Y/R) UL, LK11 (Y/R) U
Auxiliary Switch	KU1.V, KU2.V	KU1.V, KU2.V	KU1.V, KU2.V	KU1.V, KU2.V
Fuse Holder	—	—	KV 10x38, KV 10x38 CC	—

Direct Handle Version

Handle for 3 Pole	K/KU3P (Y/R)	K/KU3P (Y/R)	K/KU3P (Y/R)	K/KU3P (Y/R)
Handle for 4 Pole	K/KU4P (Y/R)	K/KU4P (Y/R)	K/KU4P (Y/R)	K/KU4P (Y/R)
Door Mounting Kits	OKA/KU LK10 x; OKA x	OKA/KU LK10 x; OKA x	OKA/KU LK10 x; OKA x	OKA/KU LK10 x; OKA x