

Back

- o Flat Cable Connectors SEK
- o *har-mik*
- o D-Sub
- o InduCom

Applications





Product details

09 33 016 2701 Female insert, Han 16 E

Series	Han E®, Han® ES/ESS, Han E® AV, Han® ES AV
Number of contacts	16 poles + PE
Size of hood/ housing	Han® 16 B
Termination	Screw term. with wire prot.
Insert material	Standard material
Contacts	Inclusive
Electrical data	16 A 500 V 6 kV 3
RoHS compliant	Yes

Inquiry

Available Downloads

Title	Format	
Data sheet	PDF	 download
CAD data 2D	DXF	 download
CAD data 3D	IGES	 download
CAD data 3D	STEP	 download

Alle Rechte vorbehalten / All rights reserved

Montageausschnitt /
panel cut out

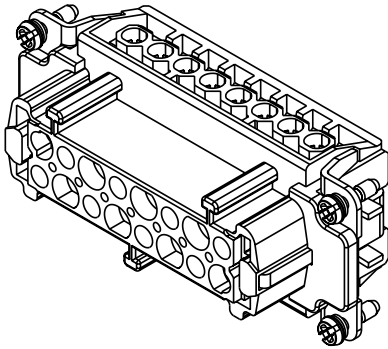
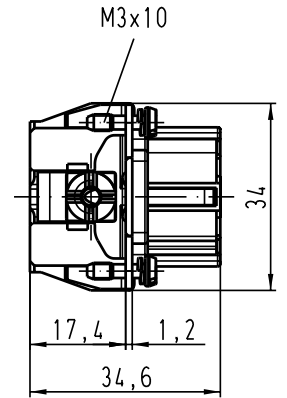
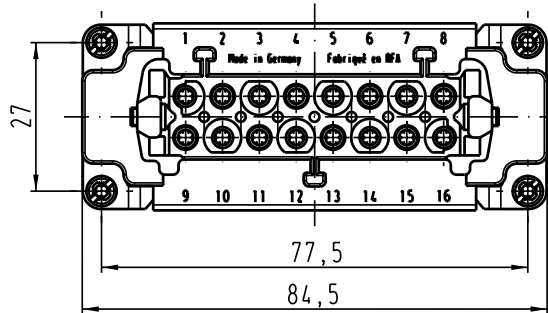
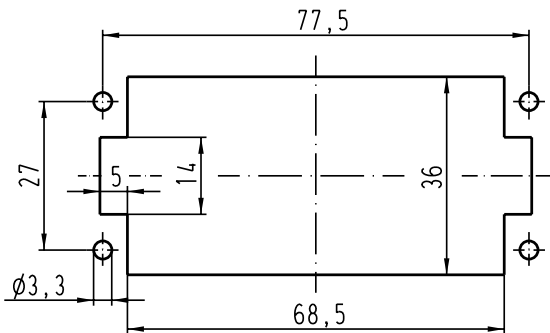

All Dimensions in mm Original Size DIN A 4		Techn. Character.			Nicht tolerierte Masse / free size tolerances	
			Dat.	Name	Massstab / Scale	Han 16E-F-s Buchseneinsatz / female insert
			Detail.	09.04.98 KR		
			Insp.	Rue.		
410526	18.07.03	Ho	Stand.		1:1	TB 09 33 016 2701 Sub.
28552	11.10.00	ROH.				
26781						
Mod.	Dat.	Name	HARTING Electric GmbH & Co. KG D-32339 Espelkamp			
						Blatt / page