

## END PLATES & ISOLATION PARTITIONS

### End Plates

End plates are used to cover the open side of sectional DIN Rail mount terminal blocks. They should be used at the end of an assembly of identical terminal blocks or whenever there is a change in the physical size of the terminal block.

- Material: polyamide 6.6
- Standard color: gray

### Isolation Partitions

Isolation partitions provide separation between terminal blocks with different potentials. When used for DC power applications, voltages of up to  $\pm 600V$  DC can be used on either side of the isolation partition. They also provide visual separation between groups of blocks.

- Material: polyamide 6.6
- Standard color: gray

### Separator Plates

Used for electrical separation of adjacent jumpers. They can be inserted after the terminal blocks have been assembled on DIN rail. There is no loss of width.

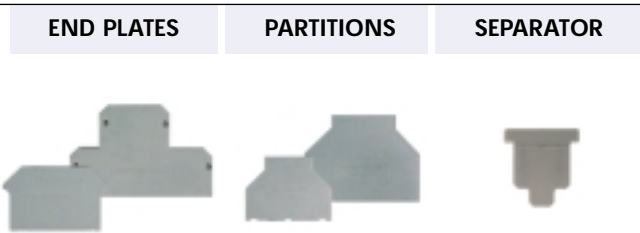

Terminal Block	END PLATES		PARTITIONS		SEPARATOR	
	Cat. No.	Std. Pk.	Cat. No.	Std. Pk.	Cat. No.	Std. Pk.
CTS2.5UN/4UN/ CTT2.5UK/T/J	EP2.5/ 4UN	50	PP2.5/4UN	50	SP2.5/4UN	100
CTS6U/10U	EP6/10U	50	PP6/10U	50		
CTS25U	EP25U	50	PP25U	50		
CTS35U	EP35U	50	PP35U	50		
CMT4/CM4S/CMT4SU	EPCMT4	50	PPCMT4	50		
CDL4U/4UIS/4U(0)/ Electronic TB	EPCDL4U	50			SPCDL4U	100
ODL4U (front)	EPODL4U	50				
ODL4U (back)	EP1ODL4U	50				
CSFL4U/CSDL4U/CSFL4U(L)	EPCSFL4U	50	PPCSFL4U	50		
DDFL4U/4U(E)/4U(E)LR/DDDL4U	EPDDL4U	25				
CAFL4U/4U(L)/4U(N)	EPCAFL4U	25				
CTL2.5U/CTL2.5U(L)	EPCTL2.5U	50				
CTL2.5UH/CTL2.5UH(L)	EPCTL2.5U-H	50				
CDTTU/CDTTU-SH	EPCDTTU	50				
CKT4U	EPCKT4U	50				
CTC4U	EPCTC4U	50				
CMC1-2	EPCMC1-2	50				
CMC2-2	EPCMC2-2	50				
CSC2.5T	EPCSC2.5T	50	PPCSC2.5T	50		
CSC4T	EPCSC4T	50	PPCSC4T	50		
CSC6T	EPCSC6T	50	PPCSC6T	50		
CSC2.5T1-2	EPCSC2.5T1-2	50				
CSC2.5T2-2	EPCSC2.5T2-2	50				
CSC4T1-2	EPCSC4T1-2	50				
CSC4T2-2	EPCSC4T2-2	50				
CMB4	EPCMB4	50			SPCM4	100

## PROTECTIVE COVER / SIDE HOLDING PLATES

For protection against dust and shock, transparent protective cover can be installed above the terminal block assembly with the aid of side/holding plates. The side holding plates can be fitted on 35 mm and 32 mm Din rails. These plates should be backed by standard end stops.

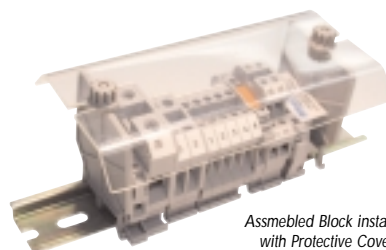

Assembled Block installed with Protective Cover



For all Rail Mounting Terminals



Mounting Accessories for CTSPC

## MARKING TAGS

The cost effective MT marking system provides quick and accurate identification. MT Push-On Marking Tags fit all Altech DIN Rail mount and panel mount terminal blocks. They can be inserted individually or as strips of 10 tags on terminal block assemblies for quick and easy marking.

MT Marking Tags are supplied blank for custom marking or they can be ordered with a horizontal or vertical imprint. The standard tag color is white with black imprint. Tags can be ordered with up to 3 characters each. Imprints can be either consecutive or identical characters. MT tags, catalog numbers MT2-MT8 are supplied in packs of identical strips, 10 tags per strip. Catalog numbers MT10-MT15 are supplied in packs of identical strips, 5 tags per strip.

MT9F is a 90 mm continuous marking strip. It can be cut to specific lengths as desired.

Group marker MTG1 is used for group identification and can be fixed on the end stop CA702.

When ordering specify strip marking as a suffix when ordering. i.e. MT2/H-1-10



Group Marker, shown imprinted and attached to CA 702. Blank and custom printing available. Cat. No. MTG1

### Tags

Blank

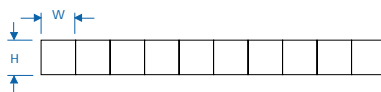

### Horizontal Tags

Consecutive Digits (Specify decade)  
Nos. 1-10, 11-20, etc. up to 100 \*  
Nos. 101-110, etc. up to 999 \*



Identical Characters (Specify digits, characters)  
Nos. 1, 2, 3 etc. up to 999 \*  
Characters A, B, up to Z,  
Symbols +, -, ⊕ \*

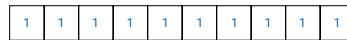

### Vertical Tags

Consecutive Digits (Specify decade)  
Nos. 1-10, 11-20, etc. up to 100  
Nos. 101-110, etc. up to 999



Identical Characters (Specify digits, characters)  
Nos. 1, 2, 3 etc. up to 999  
Characters A, B, up to Z,  
Symbols +, -, ⊕

## MT MARKING TAGS

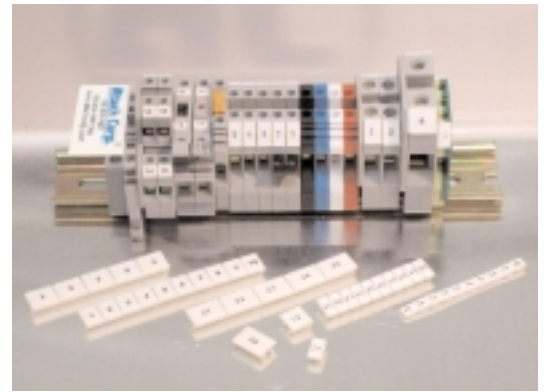

Cat. No.	Std. Strips	Pk. Tags	Dimensions	
			H	W
MT2	10	100	4.9	5.8
MT3	10	100	5.0	10.0
MT4	10	100	5.0	4.8
MT5	10	100	10.4	4.5
MT6	10	100	10.4	5.5
MT8	10	100	10.4	7.25
MT9	10	100	10.2	8.5
MT9F	10	10	10.2	90.0
MT10	20	100	10.4	10.0
MT12	20	100	10.4	11.25
MT15	20	100	10.4	15.0

Cat. No.	Std. Strips	Pk. Tags	Dimensions	
			H	W
MT2/H	10	100	4.9	5.8
MT3/H	10	100	5.0	10.0
MT4/H	10	100	5.0	4.8
MT5/H	10	100	10.4	4.5
MT6/H	10	100	10.4	5.5
MT8/H	10	100	10.4	7.25
MT9/H	10	100	10.2	8.5
MT9F/H	10	100	10.2	90.0
MT10/H	20	100	10.4	10.0
MT12/H	20	100	10.4	11.25
MT15/H	20	100	10.4	15.0

Cat. No.	Std. Strips	Pk. Tags	Dimensions	
			H	W
MT2/V	10	100	4.9	5.8
MT3/V	10	100	5.0	10.0
MT4/V	10	100	5.0	4.8
MT5/V	10	100	10.4	4.5
MT6/V	10	100	10.4	5.5
MT8/V	10	100	10.4	7.25
MT9/V	10	100	10.2	8.5
MT9F/V	10	100	10.2	90.0
MT10/V	20	100	10.4	10.0
MT12/V	20	100	10.4	11.25
MT15/V	20	100	10.4	15.0

## MARKING SYSTEMS

### Scriber VS 200

The VS200 base unit is a stand-alone plotting system with an integral keyboard and display screen. The marker fixture, plotter pen, and the memory cassette have to be inserted in the base unit to make it operational. The base unit comes in an aluminum carrying case and includes the memory cassette and the power supply. A manual is available in English and Spanish.

The VS 200 can be used to produce labels of all types, with its fixture changeable in a matter of seconds.

The Vario VS 200 makes labeling easy. The menu-driven program guides you quickly and easily through all the steps.

It can be used at any time and in any place. Easily transported in its special case, the battery-operated (battery pack sold separately) VS 200 can be operated precisely where you need it. The spacious case provides enough room for the extensive accessories.

### Plotter VS 400

The VS 400 base unit is an auxiliary plotter and has to be connected to a PC via a parallel port connection. It is a high speed plotting device and enables plotting of different markers in one setting. The marker fixture and the plotter pen have to be inserted before commencing the plotting operation. The base unit is primarily controlled through a PC with the help of Vario Sign software. Manual available in English and Spanish.

The special design of the VS 400 enables it to hold different markers from various manufacturers at the same time. It is also possible to write on relatively large markers with a maximum height 14 mm.

The Vario Sign software speeds up the labeling throughput of the VS 400.

### Fixtures

Fixtures are required for alignment of markers with respect to the plotter pen. Different marker fixtures can be mounted on the plotter bed of the VS400 at the same time thereby reducing set up times. Fixtures for different markers from various manufacturers like Altech, Allen Bradley, Connectwell, ContaClip, Entrelec, Weidmuller, Phoenix Contact, PTR, Wieland, Wago, Murrplastik, Partex, SES Sterling, etc. are available. For more information on ordering fixtures please contact Altech.

### SCRIBER VS 200



- Identifiers for connectors, wires, cables and equipment
- Cable ties, shrink tubing, labels and signs of different sizes and materials, as well as customer-specific items.
- Size: 14.9" x 7.5" x 1.77"
- Weight: 6.6 lbs.

### Ordering Information

VS 200 BASE UNIT (includes power supply, memory cassette and carrying case) .....	34000000
STARTER KIT (includes cleaning unit, pen cleaners, felt pen, plotter pen as specified) and ink cartridges .....	34000001
FIXTURES (Contact Altech for available manufactures) .....	3490xxxx
MEMORY CASSETTE .....	35500001
BATTERY PACK .....	35500000



Fixtures & Memory Cassette



Battery Pack

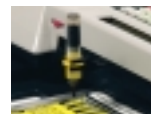

Plotter Pen, Ink Cartridge

### PLOTTER VS 400



- Identifiers for connectors, wires, cables and equipment
- Cable ties, shrink tubing, labels and signs of different sizes and materials, as well as customer-specific items.
- Size: 26.8" x 16.5" x 4.9"
- Weight: 14.3 lbs.

### Ordering Information

VS 400 BASE UNIT (includes cable) .....	34000010
STARTER KIT (includes cleaning unit, pen cleaners, felt pen, plotter pen as specified) and ink cartridges .....	34000001
FIXTURES (Contact Altech for available manufactures) .....	3490xxxx
VARIO SIGN SOFTWARE .....	34000020



Fixtures



Plotter Pen, Ink Cartridge



Vario Sign



## MARKING SYSTEMS ACCESSORIES

### PLOTTER PENS

These "tubular-nib" pens are suitable for Vario Scriber VS 200, Vario Plotter VS 400 and all current labeling and identification systems with HP penholders. They are available in six tip widths identified by body color - 0.18 mm, 0.25 mm, 0.35 mm, 0.50 mm, 0.70 mm, and 1.00 mm. Special variants for other systems are available on request. Specially designed felt-tip pens are available in a set of 4 colors (black, blue, red and green) and 2 sizes - 0.3 and 0.7 mm.



Product	Width	Order No.
EK Plotter Pen	0.18 mm	35001018
EK Plotter Pen	0.25 mm	35001025
EK Plotter Pen	0.35 mm	35001035
EK Plotter Pen	0.50 mm	35001050
EK Plotter Pen	0.70 mm	35001070
EK Plotter Pen	1.00 mm	35001100
EK Felt-tip Pen-Set	0.30 mm	35000005
EK Felt-tip Pen-Set	0.70 mm	35000010

### INK CARTRIDGES

These are easy to insert "tubular-nib" pen cartridges containing special black ink suitable for marking, identifying and labeling various plastics. It is fast drying, smudge-proof, fade resistant, and resistant to chemicals when used on suitable plastic materials.



EK Ink Cartridge (5 pieces, Black)		35100006
---------------------------------------	--	----------

### HAND PENS

The hand pens use the same special ink, as used in cartridges, and delivers the same outstanding durability and print quality. They are used for additional identification and special labeling tasks and are available in four tip widths of 0.25 mm, 0.35 mm, 0.50 mm, and 0.70 mm.



EK Hand Pen	0.25 mm	35002025
EK Hand Pen	0.35 mm	35002035
EK Hand Pen	0.50 mm	35002050
EK Hand Pen	0.70 mm	35002070

### CLEANING UNIT

It is an easy-to-use cleaning unit developed specially for EK Pens. The cleaning unit enables the pens to be rinsed thoroughly while preventing skin contact with cleaning fluid or ink. The cleaning unit can be used for up to ten cleaning cycles. The necessary precautions must be taken when disposing of cleaning fluid, the cleaning unit can be reused.



EK Cleaning Unit		35100009
------------------	--	----------



EK Pen Cleaner (2 pieces)		35100008
---------------------------	--	----------

### PEN CLEANER

This cleaning solution comes in easy to handle cartridges and is used in conjunction with the cleaning unit. A standard pack consists of two pen cleaner cartridges.

## ACCESSORIES

### Jumpering System

The jumpering systems bus potentials between terminal blocks, reducing wiring time. Adjacent blocks or selective terminal blocks within an assembly can be easily interconnected, leaving terminal clamps free for wiring. Purchase complete assemblies, which are ready for installation, or select individual components to create custom or extra long jumpers. Jumper ampacity is lower than the rated current of the respective terminal blocks, therefore, applied current must not exceed the maximum current value of the block. Internal jumpers may be used in combination with external jumpers to achieve additional jumpering possibilities.

### Internal Jumper Assemblies

Internal Jumper Assemblies consist of a Current Bar, Shorting Sleeves and screws. They install easily into the center of the terminal block and connect to the current bar. They are available as standard 2, 3, 4 or 10 pole assemblies and are ready for immediate installation.

Insulated internal jumpers provide shock protection when installed on terminal block assemblies.

### External Jumpers

External Jumpers bus potentials between terminal blocks, reducing wiring time. Adjacent or selected blocks within an assembly can be easily interconnected. Jumper poles may be removed for selective jumpering. Jumpers are insulated and available in 2, 3, 4 and 10 pole versions. They are made of tin plated brass/copper.

### Current Bars

Current Bars are offered to create custom jumper assemblies for increased number of poles or custom jumpers. Select the current bar with the required number of poles, or field cut them to the required length. They are made of tin or nickel plated copper or brass.

### Shorting Sleeves & Screws

Shorting Sleeves & Screws ensure reliable and mechanically safe electrical connections between current bars and the terminal block current bars. One shorting sleeve is required for each jumpered terminal. They are made of nickel plated brass

<sup>1</sup> Internal Jumpering System not available.

<sup>2</sup> 100 pole strip can be broken down to any number of poles desired.

## INTERNAL JUMPER



## INSULATED INTERNAL JUMPER



Terminal Series	Poles	Cat. No.	Std. Pk.	Cat. No.	Std. Pk.
CTS2.5U-N	2	CA721/2	100	CA741/2	100
	3	CA721/3	50	CA741/3	50
	4	CA721/4	50	CA741/4	50
	10	CA721/10	10	CA741/10	10
	100 <sup>2</sup>	CA721/100	5	CA741/100	5
CTS4U-N	2	CA722/2	100	CA742/2	100
	3	CA722/3	50	CA742/3	50
	4	CA722/4	50	CA742/4	50
	10	CA722/10	10	CA742/10	10
	100 <sup>2</sup>	CA722/100	5	CA742/100	5
	10 (breakable)				
CTS6U	2	CA723/2	100	CA743/2	100
	3	CA723/3	50	CA743/3	50
	4	CA723/4	50	CA743/4	50
	10	CA723/10	10	CA743/10	10
CDTTU <sup>1</sup>	2	CA724/2	100	CA744/2	100
	3	CA724/3	50	CA744/3	50
	4	CA724/4	50	CA744/4	50
	10	CA724/10	10	CA744/10	10
CDTTU-SH <sup>1</sup>	2	CA725/2	50	CA745/2	50
	3	CA725/3	25	CA745/3	25
	4	CA725/4	25	CA745/4	25
	10	CA725/10	10	CA745/10	10
CTS10U	2	CA726/2	50	CA746/2	50
	3	CA726/3	25	CA746/3	25
	4	CA726/4	25	CA746/4	25
	10	CA726/10	10	CA746/10	10
CTS25U	2	CA727/2	100	CA747/2	100
	3	CA727/3	50	CA747/3	50
	4	CA727/4	50	CA747/4	50
	10 <sup>2</sup>	CA727/10	10	CA747/10	10
	10 (breakable)				
CTS35U	2	CA729/2	100	CA749/2	100
	3	CA729/3	50	CA749/3	50
	4	CA729/4	50	CA749/4	50
	10	CA729/10	10	CA749/10	10
	10 (breakable)				
CMT4	2	CA722/2	100	CA742/2	100
	3	CA722/3	50	CA742/3	50
	4	CA722/4	50	CA742/4	50
	10	CA722/10	10	CA742/10	10
	100 <sup>2</sup>	CA722/100	5	CA742/100	5
CDL4U	2	CA729/2	100	CA749/2	100
	3	CA729/3	50	CA749/3	50
	4	CA729/4	50	CA749/4	50
	10	CA729/10	10	CA749/10	10
	10 (breakable)				
CDL4U(I.S)	2	CA729/2	100	CA749/2	100
	3	CA729/3	50	CA749/3	50
	4	CA729/4	50	CA749/4	50
	10	CA729/10	10	CA749/10	10
	10 (breakable)				
ODL4U	2	CA729/2	100	CA749/2	100
	3	CA729/3	50	CA749/3	50
	4	CA729/4	50	CA749/4	50
	10	CA729/10	10	CA749/10	10
	10 (breakable)				
CDL4U-TM	2	CA729/2	100	CA749/2	100
	3	CA729/3	50	CA749/3	50
	4	CA729/4	50	CA749/4	50
	10	CA729/10	10	CA749/10	10
	10 (breakable)				
DDFL4U	2	CA729/2	100	CA749/2	100
	3	CA729/3	50	CA749/3	50
	4	CA729/4	50	CA749/4	50
	10	CA729/10	10	CA749/10	10
	10 (breakable)				
CSFL4U <sup>1</sup>	2	CA729/2	100	CA749/2	100
	3	CA729/3	50	CA749/3	50
	4	CA729/4	50	CA749/4	50
	10	CA729/10	10	CA749/10	10
	10 (breakable)				
CSFL4U(L) <sup>1</sup>	2	CA729/2	100	CA749/2	100
	3	CA729/3	50	CA749/3	50
	4	CA729/4	50	CA749/4	50
	10	CA729/10	10	CA749/10	10
	10 (breakable)				
CSDL4U <sup>1</sup>	2	CA729/2	100	CA749/2	100
	3	CA729/3	50	CA749/3	50
	4	CA729/4	50	CA749/4	50
	10	CA729/10	10	CA749/10	10
	10 (breakable)				
CAFL4U <sup>1</sup>	2	CA729/2	100	CA749/2	100
	3	CA729/3	50	CA749/3	50
	4	CA729/4	50	CA749/4	50
	10	CA729/10	10	CA749/10	10
	10 (breakable)				
CAFL4U(L) <sup>1</sup>	2	CA729/2	100	CA749/2	100
	3	CA729/3	50	CA749/3	50
	4	CA729/4	50	CA749/4	50
	10	CA729/10	10	CA749/10	10
	10 (breakable)				
CTL2.5U	2	CA722/2	100	CA742/2	100
	3	CA722/3	50	CA742/3	50
	4	CA722/4	50	CA742/4	50
	10	CA722/10	10	CA742/10	10
	100 <sup>2</sup>	CA722/100	5	CA742/100	5
CTL2.5U(H)	2	CA722/2	100	CA742/2	100
	3	CA722/3	50	CA742/3	50
	4	CA722/4	50	CA742/4	50
	10	CA722/10	10	CA742/10	10
	100 <sup>2</sup>	CA722/100	5	CA742/100	5
CTL2.5U(L)	2	CA722/2	100	CA742/2	100
	3	CA722/3	50	CA742/3	50
	4	CA722/4	50	CA742/4	50
	10	CA722/10	10	CA742/10	10
	100 <sup>2</sup>	CA722/100	5	CA742/100	5
CTL2.5U-H(L)	2	CA722/2	100	CA742/2	100
	3	CA722/3	50	CA742/3	50
	4	CA722/4	50	CA742/4	50
	10	CA722/10	10	CA742/10	10
	100 <sup>2</sup>	CA722/100	5	CA742/100	5
CTL2.5U(I.S)	2	CA722/2	100	CA742/2	100
	3	CA722/3	50	CA742/3	50
	4	CA722/4	50	CA742/4	50
	10	CA722/10	10	CA742/10	10
	100 <sup>2</sup>	CA722/100	5	CA742/100	5
CTL2.5U(L)	2	CA722/2	100	CA742/2	100
	3	CA722/3	50	CA742/3	50
	4	CA722/4	50	CA742/4	50
	10	CA722/10	10	CA742/10	10
	100 <sup>2</sup>	CA722/100	5	CA742/100	5

## EXTERNAL JUMPER



## CURRENT BAR



## SHORTING SLEEVE & SCREWS



## Spring Clamp Terminal Block Accessories



### Jumpers



Terminal	Adjacent	Alternate	Wire Type
CSC2.5T	CA801/1	CA801/1-3	CA901/1
CSC4T	CA801/2	CA801/2-3	CA901/2
CSC6T	CA801/3	CA801/3-3	
CSC2.5T1-2	CA801/1	CA801/1-3	CA901/1
CSC2.5T2-2	CA801/1	CA801/1-3	CA901/1
CSC4T1-2	CA801/2	CA801/2-3	CA901/2
CSC4T2-2	CA801/2	CA801/2-3	CA901/2
CSCP2.5T	CA803/1		
CSCP2.5T2	CA803/1		

Cat. No.	Std. Pk.	Cat. No.	Std. Pk.	Cat. No.	Std. Pk.
CA717/2	100	CA703/01	100	CA707/S/Q/01	100
CA717/3	100	CA704/01	100	CA707/S/Q/01	100
CA717/4	100	CA705/01	100	CA707/S/Q/01	100
CA717/10	50	CA731/10	100	CA707/S/Q/01	100
CA717/100	10	CA731/100	10	CA707/S/Q/01	100
CA713/2	100	CA703/1	100	CA707/S/Q/01	100
CA713/3	100	CA704/1	100	CA707/S/Q/01	100
CA713/4	100	CA705/1	100	CA707/S/Q/01	100
CA713/10	50	CA732/10	100	CA707/S/Q/01	100
CA713/100	10	CA732/100	10	CA707/S/Q/01	100
		CA732/10-A	100	CA707/S/Q/01	100
CA710/2	100	CA703/2	100	CA707/S/Q/1	100
CA710/3	100	CA704/2	100	CA707/S/Q/1	100
CA710/4	100	CA705/2	100	CA707/S/Q/1	100
CA710/10	50	CA733/10	100	CA707/S/Q/1	100
CA718/2	100	CA703/3	100	CA707/S/Q/1	100
CA718/3	100	CA704/3	100	CA707/S/Q/1	100
CA718/4	100	CA705/3	100	CA707/S/Q/1	100
CA718/10	50	CA734/10	100	CA707/S/Q/1	100
		CA703/4	100	CA707/S/Q/2	100
		CA704/4	100	CA707/S/Q/2	100
		CA705/4	100	CA707/S/Q/2	100
		CA735/10	100	CA707/S/Q/2	100
		CA703/5	100	CA707/S/Q/2	100
		CA704/5	100	CA707/S/Q/2	100
		CA705/5	100	CA707/S/Q/2	100
		CA736/10	100	CA707/S/Q/2	100
CA714/2	100	CA703/1	100	CA607/S/Q	100
CA714/3	100	CA704/1	100	CA607/S/Q	100
CA714/4	100	CA705/1	100	CA607/S/Q	100
CA714/10	50	CA732/10	100	CA607/S/Q	100
		CA732/100	10		
		CA732/10-A	100		
CA711/2	100	CA703/6	100	CA707/S/Q/3	100
CA711/3	100	CA704/6	100	CA707/S/Q/3	100
CA711/4	100	CA705/6	100	CA707/S/Q/3	100
CA711/10	50	CA737/10	100	CA707/S/Q/3	100
CA716/2	100				
CA716/3	100				
CA716/4	100				
CA716/10	50				
CA715/2	100	CA703/1	100	CA707/S/Q/01	100
CA715/3	100	CA704/1	100	CA707/S/Q/01	100
CA715/4	100	CA705/1	100	CA707/S/Q/01	100
CA715/10	50	CA732/10	100	CA707/S/Q/01	100
		CA732/100	10	CA707/S/Q/01	100
		CA732/10-A	100	CA707/S/Q/01	100



## MOUNTING TRACKS

### For Printed Circuit Boards

### DIN Rail or Panel Mount

Mount standard or custom printed circuit boards in Mounting Tracks which can be conveniently DIN rail or panel mounted in your control panel or cabinet. These are the same tracks used for Altech interface modules. We now make them available to you to house and protect your custom boards, etc. Tracks are easily cut to size or can be ordered precut to specific lengths. They are easily assembled from standard components and snap onto 35mm DIN rail or can be panel mounted.

Each track has two sets of printed circuit board guides to accept two alternate board widths.

End Sections hold printed circuit boards securely in place and keep out foreign objects.

#### MOUNTING

When mounting extrusions on DIN rail, order two or more MTGF DIN Rail mounting feet. These feet slide into grooves on the extrusion. Then attach two EPDR DIN Rail Mount End Sections with help of EPS screws.

To panel mount, order two EPDP Panel Mount End Sections (and EPS screws), each with an integral mounting flange with a 6 x 8mm (.24 x .32 in.) hole slot.

If desired, tracks can be direct mounted using double sided tape. Order two EPDR End Sections (and EPS screws).

- Standard Lengths: 1m (3'-3") or 2m (6'-6")
- Track Material: PVC
- Temperature Limit:
  - Short Term - 80°C (176°F)
  - Continuous - 70°C (158°F)
- End Section, Foot Material: Polyamide
- Preassembled, Precut Lengths Available
- Tracks Accept Standard MT2 Marking Tags

## MTGTK

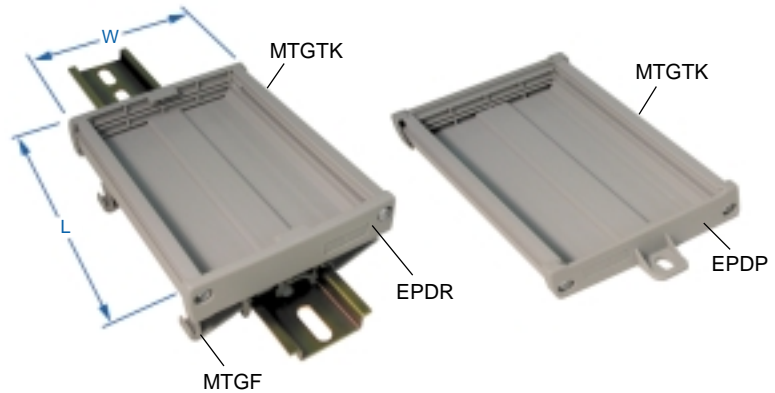

### Narrow Mounting Track Extrusion and Components

For PC Board Widths  
72.6mm (2.86) or 68.5mm (2.70)

	Cat. No.	Std. Pk.
Mounting Track		
1 meter	MTGTK/1M	5
2 meter	MTGTK	5
Accessories		
DIN Rail Mount End Section	EPDR	100
DIN Rail Mounting Foot	MTGF	100
Panel Mount End Section	EPDP	100
DIN Rail / Panel Mount End Section Screws #4x1/2", Phillips Pan head (2 required per end section)	EPS	200
Marking Tags	MT2	100

## DIN Rail Mount

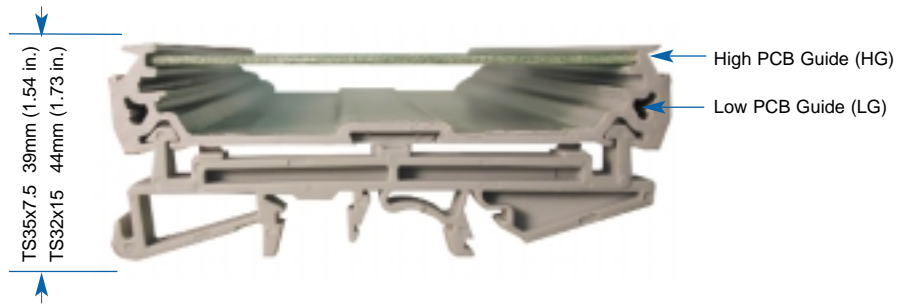

Printed circuit board shown in High Guide

## Panel Mount

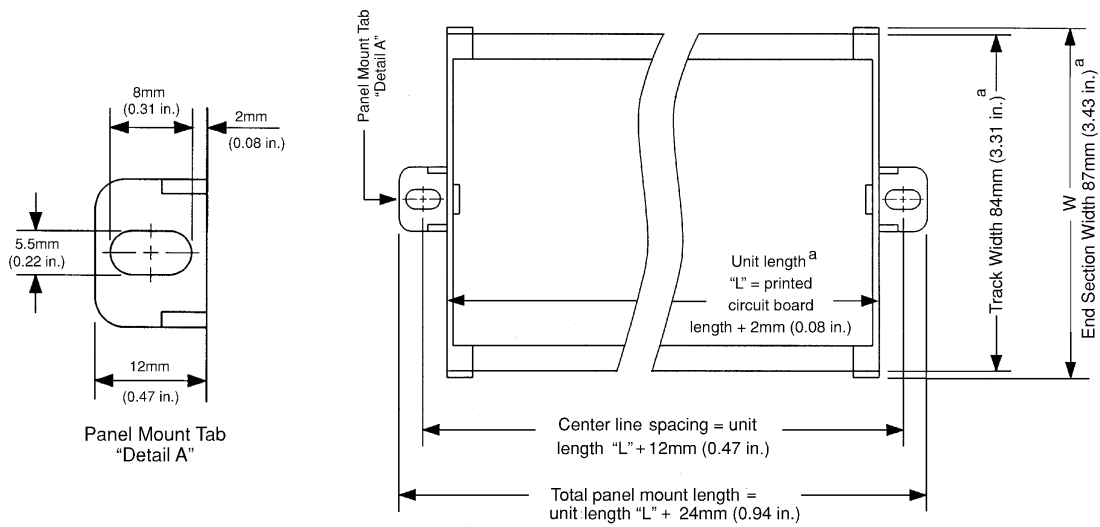

Printed circuit board shown in High Guide

## Sizing Information

Printed Circuit Board Width		
Track Type	High Guide (HG)	Low Guide (LG)
MTGTK	72.6 ± 0.2mm (2.86 ± .008 in.)	68.5 ± 0.5mm (2.70 ± .019 in.)

Mounting Track Extrusion "Cut-to-Size" Formula	
Extrusion Length = Printed Circuit Board Length - 4.5mm (.177 in.)	

<sup>a</sup>Also applies for DIN Rail Mount Unit



## RECEPTACLES

### Features:

- DIN Rail, Panel Mount or Wall Mount
- Rating: 15A/125V AC
- Finger Protection: IP20
- Available in 3 colors.

### PANEL MOUNT





### WALL MOUNT



### DIN RAIL MOUNT



External Dimension (HxWxL mm)	36.5 x 61.5 x 50	50 x 71 x 53.5	58.5 x 84 x 53.5
Stripping Length	10 mm	10 mm	10 mm
Insulation Material	Thermoplastic	Thermoplastic	Thermoplastic
Type of Connection	3 screw clamps	3 screw clamps	3 screw clamps
Approvals*			
Voltage Rating	125 V	125 V	125 V
Current Rating	15 A	15 A	15 A

	Cat. No.	Std. Pk.	Cat. No.	Std. Pk.	Cat. No.	Std. Pk.
Complete Kit:						
Blue	PMRBU	1	WMRBU	1	DMRBU	1
Gray	PMRGR	1	WMRGR	1	DMRGR	1
Black	PMRBA	1	WMRBA	1	DMRBA	1
Optional Accessory Sealing Gasket	SEALGASK	1	SEALGASK	1	SEALGASK	1

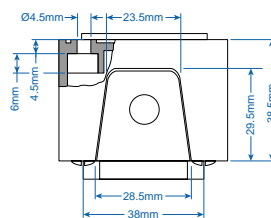
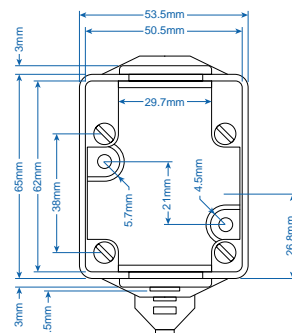
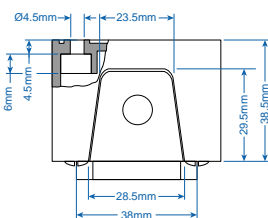
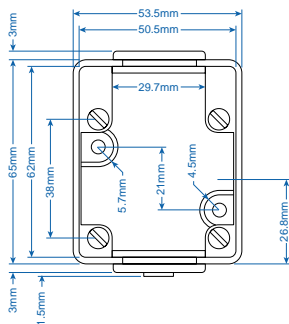
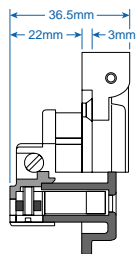
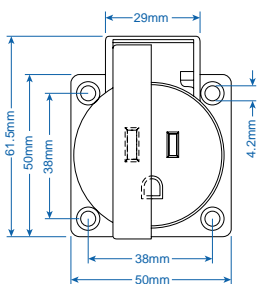

**PANEL MOUNT**

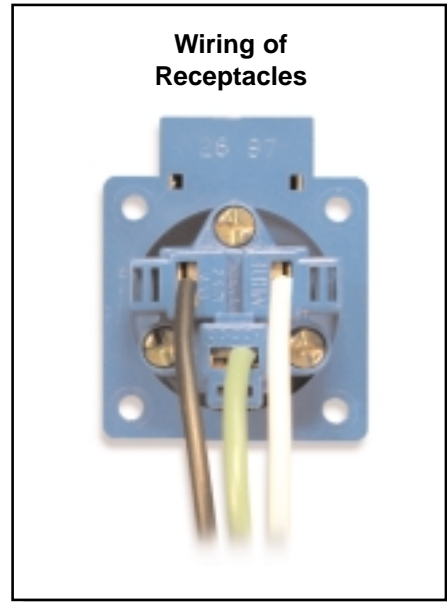
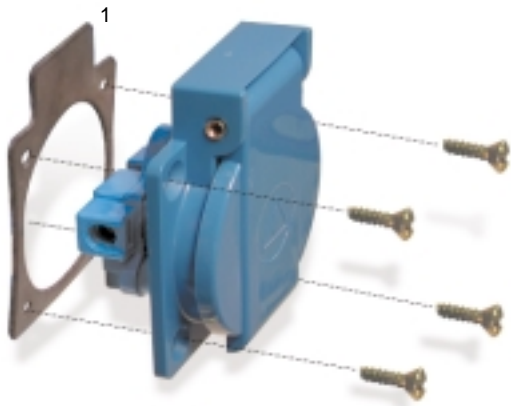

**WALL MOUNT**

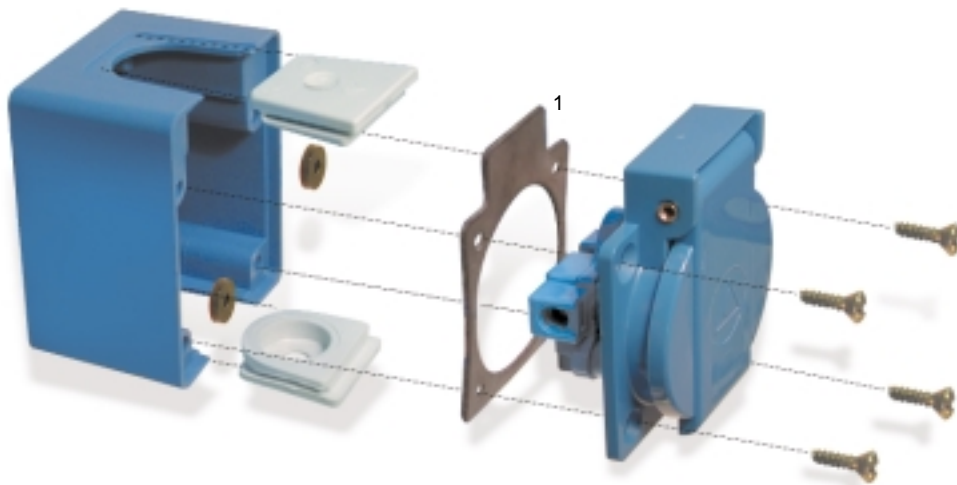

**DIN RAIL MOUNT**

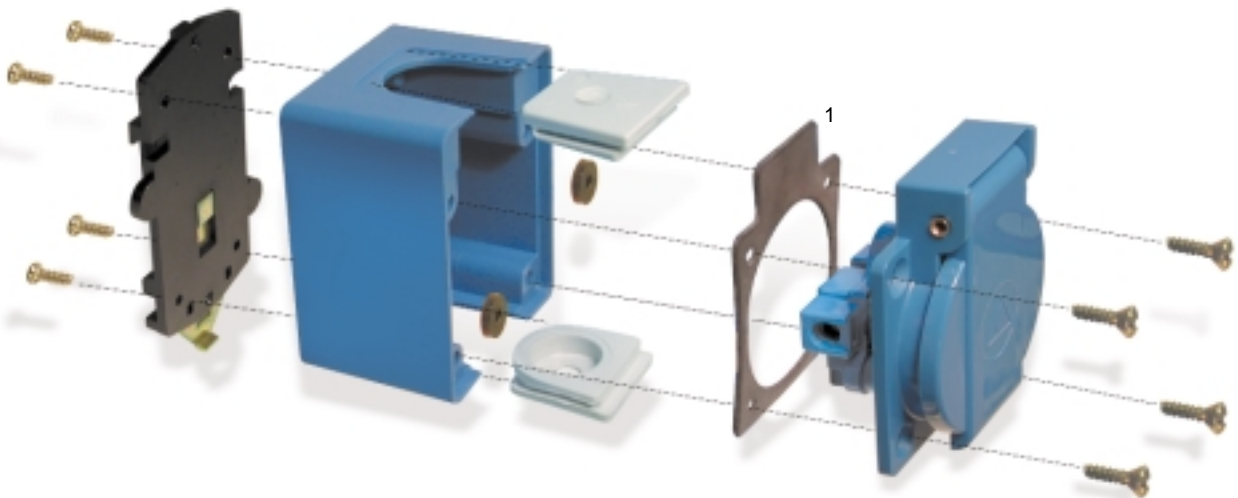

<sup>1</sup> Optional Sealing Gasket for wet environments.