

HIGH RIPPLE-REJECTION LOW DROPOUT HIGH OUTPUT CURRENT CMOS VOLTAGE REGULATOR

www.sii-ic.com

© Seiko Instruments Inc., 2007 -2010

Rev.2.0_00

The S-1172 Series, developed based on CMOS technology, is a positive voltage regulator with a super low dropout voltage, high output voltage accuracy, and low current consumption.

The S-1172 Series provides the very small dropout voltage and the large output current due to the built-in transistor with low on-resistance. The overcurrent protector prevents the load current from exceeding the capacitance of output transistor. The thermal shutdown circuit prevents damage caused by heat, the rush current control circuit limits the excessive rush current during start-up.

The ON/OFF circuit ensures longer battery life. Various capacitors, also small ceramic capacitors, can be used for this IC more than for the conventional regulator ICs which have CMOS technology.

The packages, high heat radiation HSOP-6 and small SOT-89-5 enable high-density mounting.

■ Features

- | | |
|--|---|
| • Output voltage : | 1.0 V to 5.0 V, selectable in 0.05 V step. |
| • Low equivalent series resistance capacitor : | Ceramic capacitor of 4.7 μ F or more can be used as the I/O capacitor. |
| • Input voltage : | 1.5 V to 5.5 V |
| • High-accuracy output voltage : | $\pm 1.0\%$ (1.0 V to 1.45 V output product : ± 15 mV) |
| • Low dropout voltage : | 70 mV typ. (3.0 V output product, at $I_{OUT} = 300$ mA) |
| • Low current consumption : | During operation : 70 μ A typ., 90 μ A max.
(3.0 V output product) |
| • Output current : | During shutdown : 0.1 μ A typ., 1.0 μ A max. |
| • High ripple rejection : | 1000 mA (3.0 V output product, at $V_{IN} \geq V_{OUT(S)} + 1.0$ V) ^{*1} |
| • Built-in overcurrent protection circuit : | 70 dB typ. (at 1.0 kHz, $V_{OUT} = 1.0$ V) |
| • Built-in thermal shutdown circuit : | limits overcurrent of output transistor |
| • Built-in rush current control circuit : | prevents damage caused by heat |
| • Built-in power on/off circuit : | limits excessive rush current during start-up |
| • Lead-free, Sn 100%, halogen-free ^{*2} | Longer battery life |

*1. Attention should be paid to the power dissipation of the package when the output current is large.

*2. Refer to “■ Product Name Structure” for details.

■ Applications

- Power supply for battery-powered devices
- Power supply for TV, notebook PCs and home electric appliances
- Constant-voltage power supply for portable equipment

■ Packages

- SOT-89-5
- HSOP-6

■ Block Diagram

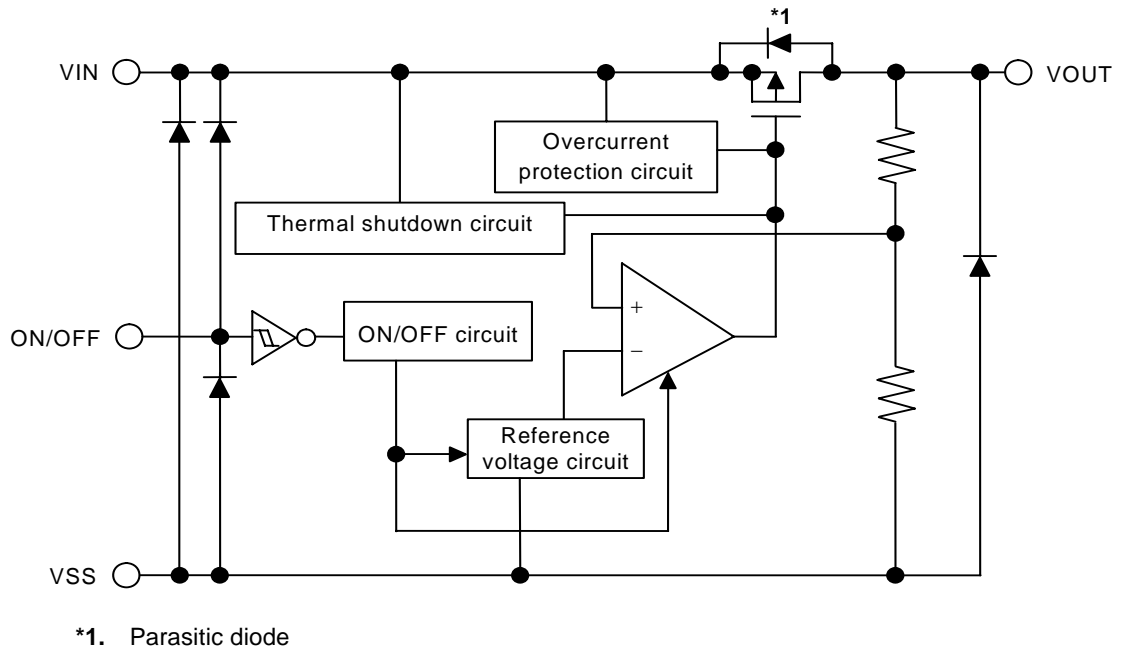
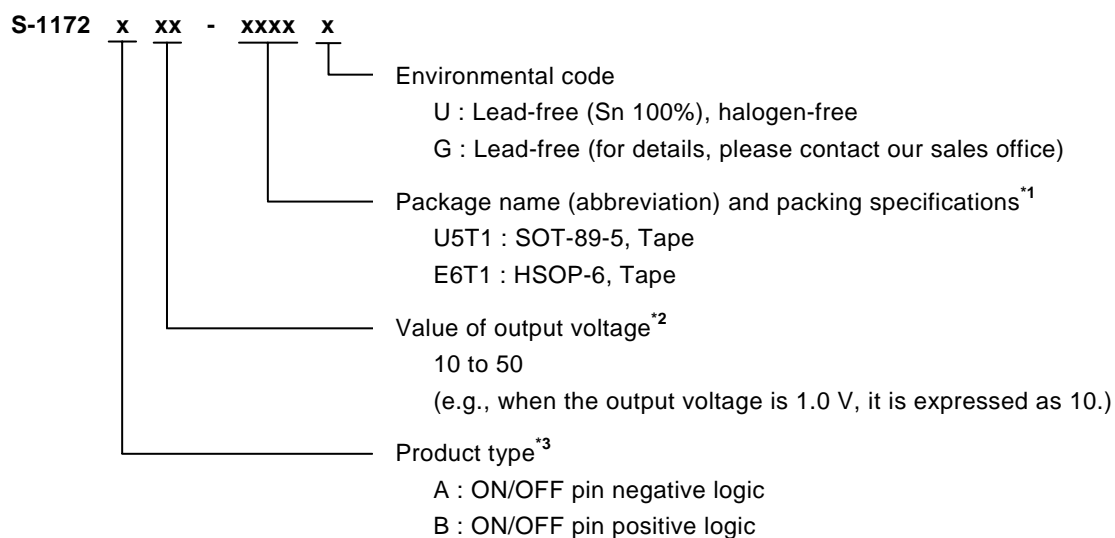

Figure 1

■ Product Name Structure

Users can select the product type, output voltage, and package type for the S-1172 Series. Refer to “1. Product Name” regarding the contents of product name, “2. Package” regarding the package drawings and “3. Product Name List” regarding details of product name.

1. Product Name



*1. Refer to the tape specifications.

*2. If you request the product which has 0.05 step, contact our sales office.

*3. Refer to “3. Shutdown pin (ON/OFF pin)” in “■ Operation”.

2. Package

Package Name	Drawing Code				
	Package	Tape	Reel	Land	
SOT-89-5	UP005-A-P-SD	UP005-A-C-SD	UP005-A-R-SD	—	
HSOP-6	Environmental code = G	FH006-A-P-SD	FH006-A-C-SD	FH006-A-R-SD	FH006-A-L-SD
	Environmental code = U	FH006-A-P-SD	FH006-A-C-SD	FH006-A-R-S1	FH006-A-L-SD

3. Product Name List

Table 1

Output Voltage	SOT-89-5	HSOP-6
1.0 V \pm 15 mV	S-1172B10-U5T1x	S-1172B10-E6T1x
1.1 V \pm 15 mV	S-1172B11-U5T1x	S-1172B11-E6T1x
1.15 V \pm 15 mV	—	S-1172B1B-E6T1x
1.2 V \pm 15 mV	S-1172B12-U5T1x	S-1172B12-E6T1x
1.25 V \pm 15 mV	S-1172B1C-U5T1x	S-1172B1C-E6T1x
1.3 V \pm 15 mV	S-1172B13-U5T1x	S-1172B13-E6T1x
1.4 V \pm 15 mV	S-1172B14-U5T1x	S-1172B14-E6T1x
1.5 V \pm 1.0%	S-1172B15-U5T1x	S-1172B15-E6T1x
1.6 V \pm 1.0%	S-1172B16-U5T1x	S-1172B16-E6T1x
1.7 V \pm 1.0%	S-1172B17-U5T1x	S-1172B17-E6T1x
1.8 V \pm 1.0%	S-1172B18-U5T1x	S-1172B18-E6T1x
1.85 V \pm 1.0%	S-1172B1J-U5T1x	S-1172B1J-E6T1x
1.9 V \pm 1.0%	S-1172B19-U5T1x	S-1172B19-E6T1x
2.0 V \pm 1.0%	S-1172B20-U5T1x	S-1172B20-E6T1x
2.1 V \pm 1.0%	S-1172B21-U5T1x	S-1172B21-E6T1x
2.2 V \pm 1.0%	S-1172B22-U5T1x	S-1172B22-E6T1x
2.3 V \pm 1.0%	S-1172B23-U5T1x	S-1172B23-E6T1x
2.4 V \pm 1.0%	S-1172B24-U5T1x	S-1172B24-E6T1x
2.5 V \pm 1.0%	S-1172B25-U5T1x	S-1172B25-E6T1x
2.6 V \pm 1.0%	S-1172B26-U5T1x	S-1172B26-E6T1x
2.7 V \pm 1.0%	S-1172B27-U5T1x	S-1172B27-E6T1x
2.8 V \pm 1.0%	S-1172B28-U5T1x	S-1172B28-E6T1x
2.85 V \pm 1.0%	S-1172B2J-U5T1x	S-1172B2J-E6T1x
2.9 V \pm 1.0%	S-1172B29-U5T1x	S-1172B29-E6T1x
3.0 V \pm 1.0%	S-1172B30-U5T1x	S-1172B30-E6T1x
3.1 V \pm 1.0%	S-1172B31-U5T1x	S-1172B31-E6T1x
3.2 V \pm 1.0%	S-1172B32-U5T1x	S-1172B32-E6T1x
3.3 V \pm 1.0%	S-1172B33-U5T1x	S-1172B33-E6T1x
3.4 V \pm 1.0%	S-1172B34-U5T1x	S-1172B34-E6T1x
3.5 V \pm 1.0%	S-1172B35-U5T1x	S-1172B35-E6T1x
3.6 V \pm 1.0%	S-1172B36-U5T1x	S-1172B36-E6T1x
3.7 V \pm 1.0%	S-1172B37-U5T1x	S-1172B37-E6T1x
3.8 V \pm 1.0%	S-1172B38-U5T1x	S-1172B38-E6T1x
3.9 V \pm 1.0%	S-1172B39-U5T1x	S-1172B39-E6T1x
4.0 V \pm 1.0%	S-1172B40-U5T1x	S-1172B40-E6T1x
4.1 V \pm 1.0%	S-1172B41-U5T1x	S-1172B41-E6T1x
4.2 V \pm 1.0%	S-1172B42-U5T1x	S-1172B42-E6T1x
4.3 V \pm 1.0%	S-1172B43-U5T1x	S-1172B43-E6T1x
4.4 V \pm 1.0%	S-1172B44-U5T1x	S-1172B44-E6T1x
4.5 V \pm 1.0%	S-1172B45-U5T1x	S-1172B45-E6T1x
4.6 V \pm 1.0%	S-1172B46-U5T1x	S-1172B46-E6T1x
4.7 V \pm 1.0%	S-1172B47-U5T1x	S-1172B47-E6T1x
4.8 V \pm 1.0%	S-1172B48-U5T1x	S-1172B48-E6T1x
4.9 V \pm 1.0%	S-1172B49-U5T1x	S-1172B49-E6T1x
5.0 V \pm 1.0%	S-1172B50-U5T1x	S-1172B50-E6T1x

- Remark 1.** Please contact our sales office for products with an output voltage other than those specified above or type A products.
2. x: G or U
 3. Please select products of environmental code = U for Sn 100%, halogen-free products.

■ Pin Configurations

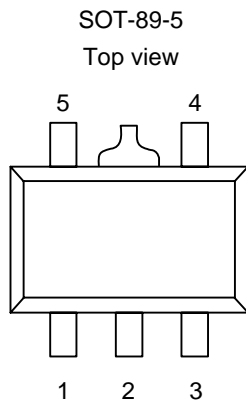

Figure 2

Table 2

Pin No.	Symbol	Description
1	ON/OFF	Shutdown pin
2	VSS	GND pin
3	NC*1	No connection
4	VIN	Input voltage pin
5	VOUT	Output voltage pin

*1. The NC pin is electrically open.
The NC pin can be connected to VIN or VSS.

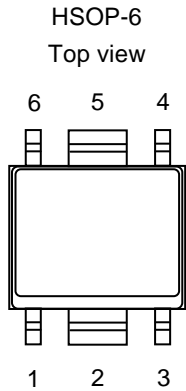

Figure 3

Table 3

Pin No.	Symbol	Description
1	VOUT	Output voltage pin
2	VSS	GND pin
3	ON/OFF	Shutdown pin
4	NC*1	No connection
5	VSS	GND pin
6	VIN	Input voltage pin

*1. The NC pin is electrically open.
The NC pin can be connected to VIN or VSS.

■ **Absolute Maximum Ratings**

Caution The absolute maximum ratings are rated values exceeding which the product could suffer physical damage. These values must therefore not be exceeded under any conditions.

Table 4

(Ta = 25°C unless otherwise specified)

Item		Symbol	Absolute Maximum Ratings	Unit
Input voltage		V _{IN}	V _{SS} - 0.3 to V _{SS} + 6	V
		V _{ON/OFF}	V _{SS} - 0.3 to V _{IN} + 0.3	V
Output voltage		V _{OUT}	V _{SS} - 0.3 to V _{IN} + 0.3	V
Power dissipation	SOT-89-5	P _D	1000 ^{*1}	mW
	HSOP-6		1900 ^{*2}	mW
Operating ambient temperature		T _{opr}	-40 to +85	°C
Storage temperature		T _{stg}	-40 to +125	°C

*1. When mounted on board

[Mounted board]

- (1) Board size : 114.3 mm × 76.2 mm × t1.6 mm
- (2) Name : JEDEC STANDARD51-7

*2. When mounted on board

[Mounted board]

- (1) Board size : 50 mm × 50 mm × t1.6 mm
- (2) Board material : Glass epoxy resin (two layers)
- (3) Wiring ratio : 50%
- (4) Test conditions : When mounted on board (wind speed : 0 m / s)
- (5) Land pattern : Refer to the recommended land pattern (drawing code : FH006-A-L-SD)

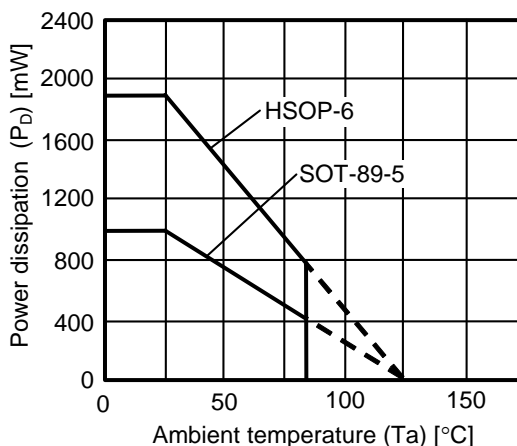

Figure 4 Power Dissipation of Package (When Mounted on Board)

Table 5

Condition	Power Dissipation	Thermal Resistance Value (θj-a)
HSOP-6 (When mounted on board)	1900 mW	53°C / W
SOT-89-5 (When mounted on board)	1000 mW	100°C / W

Power Dissipation of HSOP-6 (Reference)

Power dissipation of package differs depending on the mounting conditions.
 Consider the power dissipation characteristics under the following conditions as reference.

[Mounted board]

- (1) Board size : 50 mm × 50 mm × t1.6 mm
- (2) Board material : Glass epoxy resin (two layers)
- (3) Wiring ratio : 90%
- (4) Test conditions : When mounted on board (wind speed : 0 m / s)
- (5) Land pattern : Refer to the recommended land pattern (drawing code : FH006-A-L-SD)

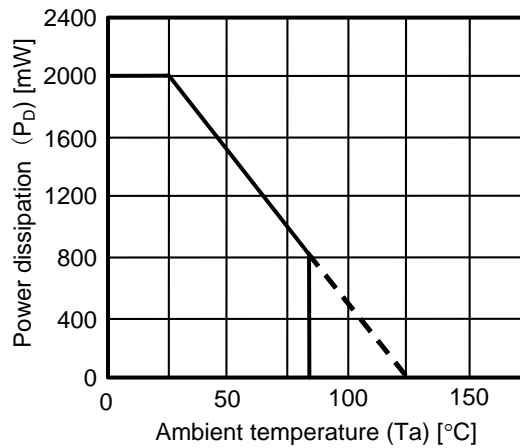

Figure 5 Power Dissipation of Package (When Mounted on Board)

Table 6

Condition	Power Dissipation (Reference)	Thermal Resistance Value (θ_{j-a})
HSOP-6 (When mounted on board)	2000 mW	50°C / W

■ Electrical Characteristics

Table 7 (1 / 2)

(Ta = 25°C unless otherwise specified)

Item	Symbol	Conditions	Min.	Typ.	Max.	Unit	Test Circuit	
Output voltage ^{*1}	V _{OUT(E)}	V _{IN} = V _{OUT(S)} + 1.0 V, I _{OUT} = 100 mA	1.0 V ≤ V _{OUT(S)} < 1.5 V	V _{OUT(S)} − 0.015	V _{OUT(S)}	V _{OUT(S)} + 0.015	V	1
			1.5 V ≤ V _{OUT(S)} ≤ 4.5 V	V _{OUT(S)} × 0.99	V _{OUT(S)}	V _{OUT(S)} × 1.01	V	1
		V _{IN} = 5.5 V, I _{OUT} = 100 mA	4.5 V < V _{OUT(S)} ≤ 5.0 V	V _{OUT(S)} × 0.99	V _{OUT(S)}	V _{OUT(S)} × 1.01	V	1
Output current ^{*2}	I _{OUT}	V _{IN} ≥ V _{OUT(S)} + 1.0 V	1.0 V ≤ V _{OUT(S)} ≤ 4.5 V	1000 ^{*5}	–	–	mA	3
		V _{IN} = 5.5 V	4.5 V < V _{OUT(S)} ≤ 5.0 V	1000 ^{*5}	–	–	mA	3
Dropout voltage ^{*3}	V _{drop}	I _{OUT} = 300 mA	1.0 V ≤ V _{OUT(S)} < 1.1 V	0.5	0.54	0.58	V	1
			1.1 V ≤ V _{OUT(S)} < 1.2 V	–	0.44	0.48	V	1
			1.2 V ≤ V _{OUT(S)} < 1.3 V	–	0.34	0.38	V	1
			1.3 V ≤ V _{OUT(S)} < 1.4 V	–	0.24	0.28	V	1
			1.4 V ≤ V _{OUT(S)} < 1.5 V	–	0.14	0.18	V	1
			1.5 V ≤ V _{OUT(S)} < 2.6 V	–	0.10	0.15	V	1
			2.6 V ≤ V _{OUT(S)} ≤ 5.0 V	–	0.07	0.10	V	1
		I _{OUT} = 1000 mA	1.0 V ≤ V _{OUT(S)} < 1.1 V	–	0.9	–	V	1
			1.1 V ≤ V _{OUT(S)} < 1.2 V	–	0.8	–	V	1
			1.2 V ≤ V _{OUT(S)} < 1.3 V	–	0.7	–	V	1
			1.3 V ≤ V _{OUT(S)} < 1.4 V	–	0.6	–	V	1
			1.4 V ≤ V _{OUT(S)} < 1.5 V	–	0.5	–	V	1
			1.5 V ≤ V _{OUT(S)} < 2.0 V	–	0.4	–	V	1
			2.0 V ≤ V _{OUT(S)} < 2.6 V	–	0.32	–	V	1
Line regulation	$\frac{\Delta V_{OUT1}}{\Delta V_{IN} \cdot V_{OUT}}$	V _{OUT(S)} + 0.5 V ≤ V _{IN} ≤ 5.5 V, I _{OUT} = 100 mA	1.0 V ≤ V _{OUT(S)} < 3.6 V	–	0.05	0.2	%/V	1
			3.6 V ≤ V _{OUT(S)} ≤ 4.8 V	–	2.5	10	mV	1
		5.3 V ≤ V _{IN} ≤ 5.5 V, I _{OUT} = 100 mA	4.8 V < V _{OUT(S)} ≤ 5.0 V	–	2.5	10	mV	1
Load regulation	ΔV _{OUT2}	V _{IN} = V _{OUT(S)} + 1.0 V, 1 mA ≤ I _{OUT} ≤ 300 mA	1.0 V ≤ V _{OUT(S)} ≤ 4.5 V	–	15	30	mV	1
		V _{IN} = 5.5 V, 1 mA ≤ I _{OUT} ≤ 300 mA	4.5 V < V _{OUT(S)} ≤ 5.0 V	–	15	30	mV	1
Output voltage temperature coefficient ^{*4}	$\frac{\Delta V_{OUT}}{\Delta Ta \cdot V_{OUT}}$	V _{IN} = V _{OUT(S)} + 1.0 V, I _{OUT} = 100 mA, −40 ≤ Ta ≤ 85°C	1.0 V ≤ V _{OUT(S)} ≤ 4.5 V	–	±130	–	ppm/°C	1
		V _{IN} = 5.5 V, I _{OUT} = 100 mA, −40 ≤ Ta ≤ 85°C	4.5 V < V _{OUT(S)} ≤ 5.0 V	–	±130	–	ppm/°C	1
Current consumption during operation	I _{SS1}	V _{IN} = V _{OUT(S)} + 1.0 V, ON/OFF pin = ON, no load, 1.0 V ≤ V _{OUT(S)} < 1.8 V		–	90	110	μA	2
		V _{IN} = V _{OUT(S)} + 1.0 V, ON/OFF pin = ON, no load, 1.8 V ≤ V _{OUT(S)} ≤ 4.5 V		–	70	90	μA	2
		V _{IN} = 5.5 V, ON/OFF pin = ON, no load, 4.5 V < V _{OUT(S)} ≤ 5.0 V		–	70	90	μA	2
Current consumption during shutdown	I _{SS2}	V _{IN} = V _{OUT(S)} + 1.0 V, ON/OFF pin = OFF, no load	1.0 V ≤ V _{OUT(S)} ≤ 4.5 V	–	0.1	1.0	μA	2
		V _{IN} = 5.5 V, ON/OFF pin = OFF, no load	4.5 V < V _{OUT(S)} ≤ 5.0 V	–	0.1	1.0	μA	2
Input voltage	V _{IN}	–	1.5	–	5.5	V	–	

Table 7 (2 / 2)

(Ta = 25°C unless otherwise specified)

Item	Symbol	Conditions	Min.	Typ.	Max.	Unit	Test Circuit	
Shutdown pin input voltage "H"	V _{SH}	V _{IN} = V _{OUT(S)} + 1.0 V, R _L = 1.0 kΩ, determined by V _{OUT} output level 1.0 V ≤ V _{OUT(S)} ≤ 4.5 V	1.0	–	–	V	4	
		V _{IN} = 5.5 V, R _L = 1.0 kΩ, determined by V _{OUT} output level 4.5 V < V _{OUT(S)} ≤ 5.0 V	1.0	–	–	V	4	
Shutdown pin input voltage "L"	V _{SL}	V _{IN} = V _{OUT(S)} + 1.0 V, R _L = 1.0 kΩ, determined by V _{OUT} output level 1.0 V ≤ V _{OUT(S)} ≤ 4.5 V	–	–	0.3	V	4	
		V _{IN} = 5.5 V, R _L = 1.0 kΩ, determined by V _{OUT} output level 4.5 V < V _{OUT(S)} ≤ 5.0 V	–	–	0.3	V	4	
Shutdown pin input current "H"	I _{SH}	V _{IN} = 5.5 V, V _{ON/OFF} = 5.5 V	–0.1	–	0.1	μA	4	
Shutdown pin input current "L"	I _{SL}	V _{IN} = 5.5 V, V _{ON/OFF} = 0 V	–0.1	–	0.1	μA	4	
Ripple rejection	RR	V _{IN} = V _{OUT(S)} + 1.0 V, f = 1 kHz, ΔV _{rip} = 0.5 V _{rms} , I _{OUT} = 100 mA	1.0 V ≤ V _{OUT(S)} < 1.2 V	–	70	–	dB	5
			1.2 V ≤ V _{OUT(S)} ≤ 3.0 V	–	65	–	dB	5
			3.0 V < V _{OUT(S)} ≤ 4.5 V	–	60	–	dB	5
		V _{IN} = 5.5 V, f = 1 kHz, ΔV _{rip} = 0.5 V _{rms} , I _{OUT} = 100 mA	4.5 V < V _{OUT(S)} ≤ 5.0 V	–	60	–	dB	5
Short-circuit current	I _{SHORT}	V _{IN} = V _{OUT(S)} + 1.0 V, ON/OFF pin = ON, V _{OUT} = 0 V 1.0 V ≤ V _{OUT(S)} ≤ 4.5 V	–	200	–	mA	3	
		V _{IN} = 5.5 V, ON/OFF pin = ON, V _{OUT} = 0 V 4.5 V < V _{OUT(S)} ≤ 5.0 V	–	200	–	mA	3	
Thermal shutdown detection temperature	T _{SD}	Junction temperature	–	150	–	°C	–	
Thermal shutdown release temperature	T _{SR}	Junction temperature	–	120	–	°C	–	

- *1. V_{OUT(S)}: Specified output voltage
V_{OUT(E)}: Actual output voltage
The output voltage when fixing I_{OUT} (= 100 mA) and inputting V_{OUT(S)} + 1.0 V or 5.5 V
- *2. The output current at which the output voltage becomes 95% of V_{OUT(E)} after gradually increasing the output current.
- *3. V_{drop} = V_{IN1} – (V_{OUT3} × 0.98)
V_{OUT3} is the output voltage when V_{IN} = V_{OUT(S)} + 1.0 V or 5.5 V, and I_{OUT} = 300 mA or 1000 mA.
V_{IN1} is the input voltage at which the output voltage becomes 98% of V_{OUT3} after gradually decreasing the input voltage.
- *4. The change in temperature [mV/°C] is calculated using the following equation.

$$\frac{\Delta V_{OUT}}{\Delta T_a} [\text{mV}/^\circ\text{C}]^{\ast 1} = V_{OUT(S)} [\text{V}]^{\ast 2} \times \frac{\Delta V_{OUT}}{\Delta T_a \bullet V_{OUT}} [\text{ppm}/^\circ\text{C}]^{\ast 3} \div 1000$$
 - *1. Change in temperature of the output voltage
 - *2. Specified output voltage
 - *3. Output voltage temperature coefficient
- *5. The output current can be at least this value.
Due to limitation of the package power dissipation, this value may not be satisfied. Attention should be paid to the power dissipation of the package when the output current is large.
This specification is guaranteed by design.

■ Test Circuits

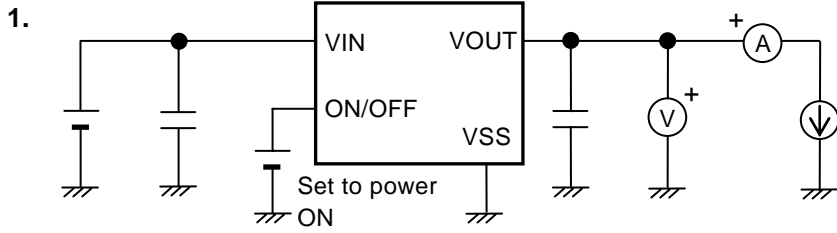

Figure 6

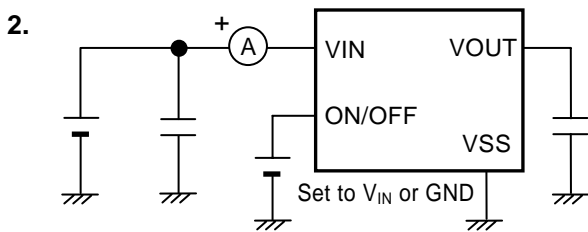

Figure 7

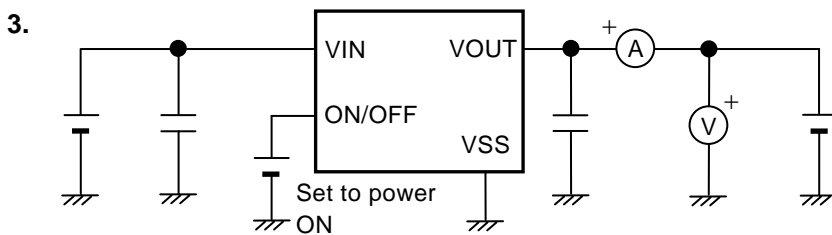

Figure 8

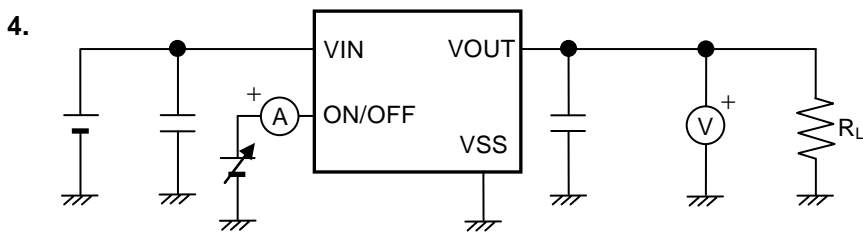

Figure 9

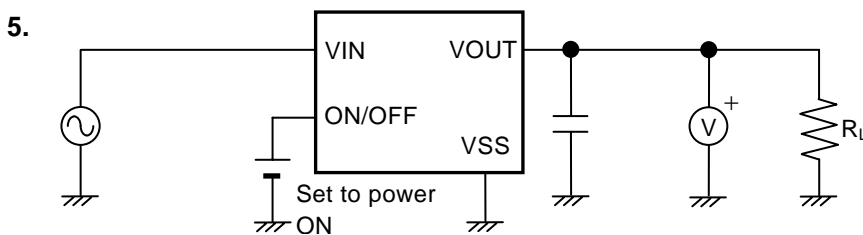
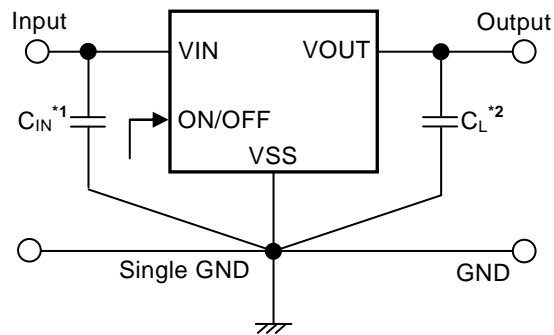

Figure 10

■ Standard Circuit



*1. C_{IN} is a capacitor for stabilizing the input.

*2. Ceramic capacitor of 4.7 μF or more can be used as C_L .

Figure 11

Caution The above connection diagram and constant will not guarantee successful operation. Perform thorough evaluation using the actual application to set the constant.

■ Application Conditions

Input capacitor (C_{IN}) : 4.7 μF or more

Output capacitor (C_L) : 4.7 μF or more (ceramic capacitor)

- Caution**
1. Set input capacitor (C_{IN}) and output capacitor (C_L) as $C_{IN} = C_L$.
 2. Generally, series regulator may oscillate depending on the external components. Confirm that no oscillation occurs in the application for which the above capacitors are used.

■ Selection of Input and Output Capacitors (C_{IN} , C_L)

The S-1172 Series requires an output capacitor between the VOUT and VSS pin for phase compensation. Operation is stabilized by a ceramic capacitor with an output capacitance of 4.7 μF or more over the entire temperature range. When using an OS capacitor, a tantalum capacitor, or an aluminum electrolytic capacitor, the capacitance must be 4.7 μF or more.

The values of output overshoot and undershoot, which are transient response characteristics, vary depending on the value of output capacitor.

The required value of capacitance for the input capacitor differs depending on the application.

Set the value for input capacitor (C_{IN}) and output capacitor (C_L) as follows.

$$C_{IN} \geq 4.7 \mu\text{F}$$

$$C_L \geq 4.7 \mu\text{F}$$

$$C_{IN} = C_L$$

Caution The S-1172 Series may oscillate if setting the value as $C_{IN} \geq 4.7 \mu\text{F}$, $C_L \geq 4.7 \mu\text{F}$, $C_{IN} < C_L$. Define the values by sufficient evaluation including the temperature characteristics under the usage condition.

■ Explanation of Terms

1. Low dropout voltage regulator

This IC's voltage regulator has the low dropout voltage due to its built-in transistor with low on-resistance.

2. Output voltage (V_{OUT})

The accuracy of the output voltage is ensured at $\pm 1.0\%$ or $\pm 15 \text{ mV}^2$ under the specified conditions of fixed input voltage^{*1}, fixed output current, and fixed temperature.

*1. Differs depending on the product.

*2. When $V_{OUT} < 1.5 \text{ V}$: $\pm 15 \text{ mV}$, When $1.5 \text{ V} \leq V_{OUT}$: $\pm 1.0\%$

Caution If the above conditions change, the output voltage value may vary and exceed the accuracy range of the output voltage. See “■ Electrical Characteristics” and “■ Characteristics (Typical Data)” for details.

3. Line regulation $\left(\frac{\Delta V_{OUT1}}{\Delta V_{IN} \bullet V_{OUT}} \right)$

Indicates the dependency of the output voltage against the input voltage. That is, the value shows how much the output voltage changes due to a change in the input voltage after fixing output current constant.

4. Load regulation (ΔV_{OUT2})

Indicates the dependency of the output voltage against the output current. That is, the value shows how much the output voltage changes due to a change in the output current after fixing output current constant.

5. Dropout voltage (V_{drop})

Indicates the difference between the output voltage and the input voltage V_{IN1} , which is the input voltage (V_{IN}) when; decreasing input voltage V_{IN} gradually until the output voltage has dropped to the value of 98% of output voltage V_{OUT3} , which is at $V_{IN} = V_{OUT(S)} + 1.0 \text{ V}$ or 5.5 V .

$$V_{drop} = V_{IN1} - (V_{OUT3} \times 0.98)$$

6. Temperature coefficient of output voltage $\left(\frac{\Delta V_{OUT}}{\Delta T_a \bullet V_{OUT}} \right)$

The shadowed area in **Figure 12** is the range where V_{OUT} varies in the operating temperature range when the temperature coefficient of the output voltage is $\pm 130 \text{ ppm}/^\circ\text{C}$.

Ex. S-1172B30 Typ.

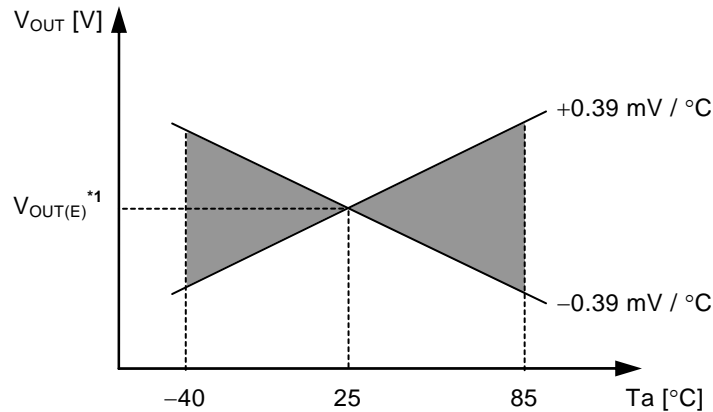

*1. $V_{OUT(E)}$ is the value of the output voltage measured at 25°C.

Figure 12

A change in the temperature of the output voltage [$\text{mV}/^\circ\text{C}$] is calculated using the following equation.

$$\frac{\Delta V_{OUT}}{\Delta T_a} [\text{mV}/^\circ\text{C}]^{*1} = V_{OUT(S)} [\text{V}]^{*2} \times \frac{\Delta V_{OUT}}{\Delta T_a \bullet V_{OUT}} [\text{ppm}/^\circ\text{C}]^{*3} \div 1000$$

- *1. Change in temperature of output voltage
- *2. Specified output voltage
- *3. Output voltage temperature coefficient

3. Shutdown pin (ON/OFF pin)

This pin starts and stops the regulator.

When the ON/OFF pin is set to the shutdown level, the entire internal circuit stops operating, and the built-in P-channel MOS FET output transistor between the VIN and VOUT pin is turned off, in order to reduce the current consumption significantly. The VOUT pin is set to the V_{SS} level by the internal dividing resistor of several hundred $k\Omega$ between the VOUT and VSS pin.

Note that the current consumption increases when a voltage of 0.3 V to 1.0 V is applied to the ON/OFF pin.

The ON/OFF pin is configured as shown in **Figure 14**. Since the ON/OFF pin is neither pulled down nor pulled up internally, do not use it in the floating state.

When not using the ON/OFF pin, connect it to the VSS pin in the product A type, and connect it to the VIN pin in B type.

Table 8

Logic Type	ON/OFF Pin	Internal Circuits	VOUT Pin Voltage	Current Consumption
A	"L": Power on	Operate	Set value	I_{SS1}
A	"H": Power off	Stop	V_{SS} level	I_{SS2}
B	"L": Power off	Stop	V_{SS} level	I_{SS2}
B	"H": Power on	Operate	Set value	I_{SS1}

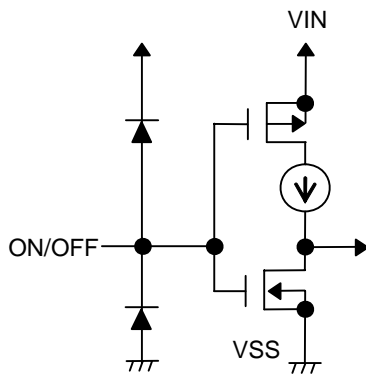

Figure 14

4. Overcurrent protection circuit

The S-1172 Series has an overcurrent protection circuit having the characteristics shown in **(1) Output Voltage vs. Output Current (When load current is increased) ($T_a = 25^\circ\text{C}$)** in "■ Characteristics (Typical Data)", in order to protect the output transistor against an excessive output current and short circuiting between the VOUT and VSS pin. The current (I_{SHORT}) when the output pin is short-circuited is internally set at approx. 200 mA (Typ.), and the initial value is restored for the output voltage, if releasing a short circuit once.

Caution This overcurrent protection circuit does not work as for thermal protection. If this IC long keeps short circuiting inside, pay attention to the conditions of input voltage and load current so that, under the usage conditions including short circuit, the loss of the IC will not exceed power dissipation of the package.

5. Thermal shutdown circuit

The S-1172 Series has a thermal shutdown circuit to protect the device from damage due to overheat. When the junction temperature rises to 150°C (Typ.), the thermal shutdown circuit operates to stop regulating. When the junction temperature drops to 120°C (Typ.), the thermal shutdown circuit is released to restart regulating. Due to self-heating of the S-1172 Series, if the thermal shutdown circuit starts operating, it stops regulating so that the output voltage drops. When regulation stops, the S-1172 does not itself generate heat so that the IC's temperature drops. When the temperature drops, the thermal shutdown circuit is released to restart regulating, thus this IC generates heat again. Repeating this procedure makes waveform of the output voltage pulse-like form. Stop / Restart of regulation continues unless decreasing either / both of the input voltage and the output voltage in order to reduce the internal current consumption, or decreasing the ambient temperature.

Table 9

Thermal Shutdown Circuit	VOUT Pin Voltage
Operation : 150°C (Typ.) ^{*1}	V _{ss} level
Release : 120°C (Typ.) ^{*1}	Set value

*1. Junction temperature

6. Rush current control circuit

The S-1172 Series has a rush current control circuit to control the rush current generated during power-on or when the ON/OFF pin is ON. This circuit limits the rush current (500 mA, Typ.) immediately after power-on or from the ON/OFF pin is ON until the specified time (100 μs min.) which is set internally.

Caution The junction temperature drops to 120°C (Typ.) by the operation of thermal shutdown circuit, after stopping regulation, the circuit is released to restart regulation; in this case, note that the period to limit rush current may become shorter (10 μs min.).

■ Precautions

- Wiring patterns for the VIN, VOUT and GND pins should be designed so that the impedance is low. When mounting an output capacitor between the VOUT and VSS pin (C_L) and a capacitor for stabilizing the input between the VIN and VSS pin (C_{IN}), the distance from the capacitors to these pins should be as short as possible.
- Note that the output voltage may increase when a series regulator is used at low load current (1.0 mA or less).
- Note that the output voltage may generally increase due to the leakage current from a driver when a series regulator is used at high temperature.
- Generally series regulator may oscillate, depending on the selection of external parts. The following conditions are recommended for this IC. However, be sure to perform sufficient evaluation under the actual usage conditions for selection, including the temperature characteristics. Regarding the equivalent series resistance (R_{ESR}) for the output capacitor, refer to **(5) Example of Equivalent Series Resistance vs. Output Current Characteristics ($T_a = 25^\circ\text{C}$)** in “**■ Reference Data**”.

Input capacitor (C_{IN}) : 4.7 μF or more

Output capacitor (C_L) : 4.7 μF or more

- The voltage regulator may oscillate when the impedance of the power supply is high and the input capacitance is small, or an input capacitor is not connected. Note that the voltage regulator may oscillate when the value of the input capacitor is greater than that of the output capacitor.
- Ringing may occur when these three conditions below are satisfied. Before selecting an input capacitor, be sure to evaluate sufficiently under the actual usage conditions, including the temperature characteristics.

The power supply inductance is high.

The load current is 100 mA or more.

The difference between the input voltage and the output voltage is close to the value of dropout voltage.

- If the output capacitance is small, power supply's fluctuation and the characteristics of load fluctuation become worse. Sufficiently evaluate the output voltage's fluctuation with the actual device.
- A momentary overshoot may be output when the power supply suddenly increases, and the output capacitance is small. It is therefore important to sufficiently evaluate the output voltage at power application in actual device.
- The application conditions for the input voltage, output voltage, and load current should not exceed power dissipation of the package.
- Do not apply an electrostatic discharge to this IC that exceeds the performance ratings of the built-in electrostatic protection circuit.
- In determining the output current, attention should be paid to the output current value specified in **Table 7** in “**■ Electrical Characteristics**” and footnote *5 of the table.
- SII claims no responsibility for any disputes arising out of or in connection with any infringement by products including this IC of patents owned by a third party.

■ **Characteristics (Typical Data)**

(1) **Output Voltage vs. Output Current (when load current is increased) (Ta = 25°C)**

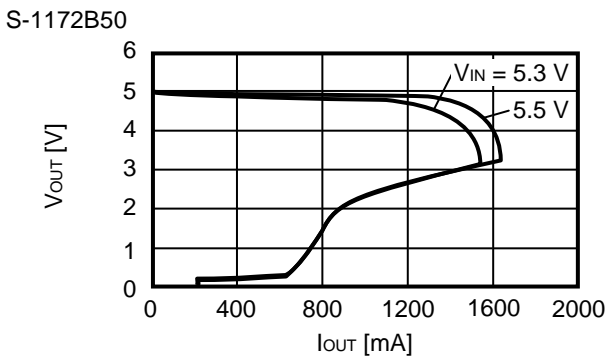
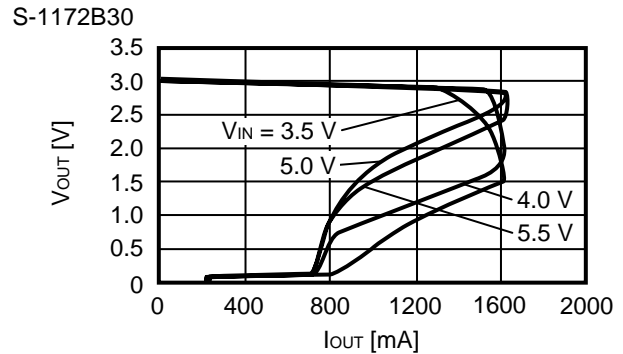
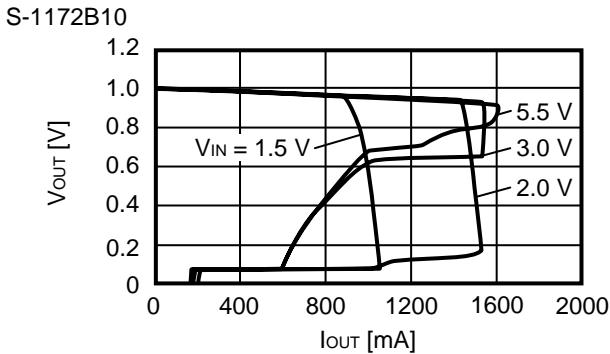

Remark In determining the output current, attention should be paid to the following.

1. The minimum value of output current in **Table 7** and footnote *5 in “■ **Electrical Characteristics**”
2. Power dissipation of the package

(2) **Output Voltage vs. Input Voltage (Ta = 25°C)**

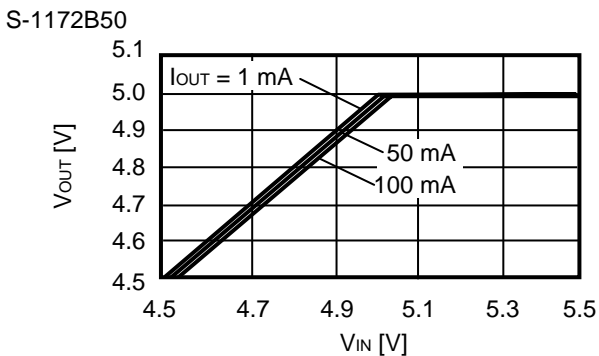
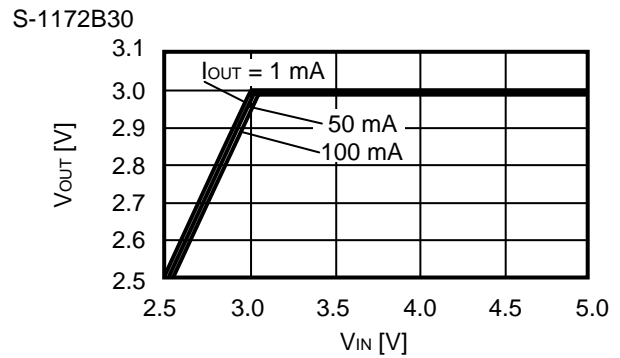
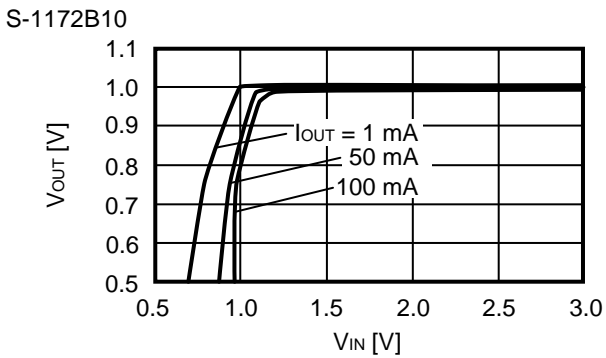

(3) Dropout Voltage vs. Output Current

S-1172B10

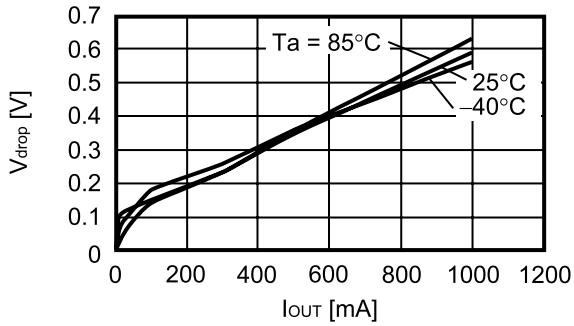

S-1172B30

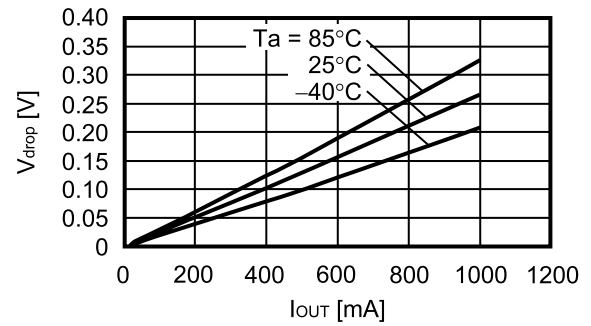

S-1172B50

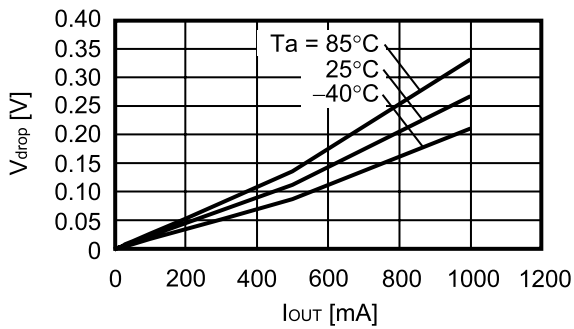

(4) Dropout Voltage vs. Set Output Voltage

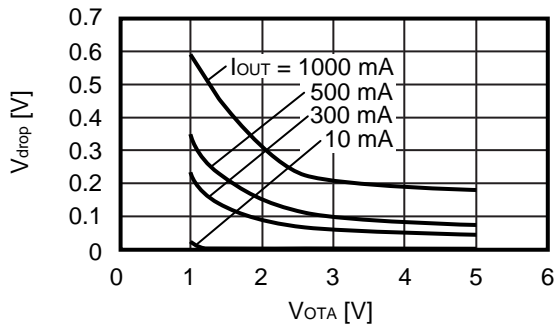

(5) Output Voltage vs. Ambient Temperature

S-1172B10

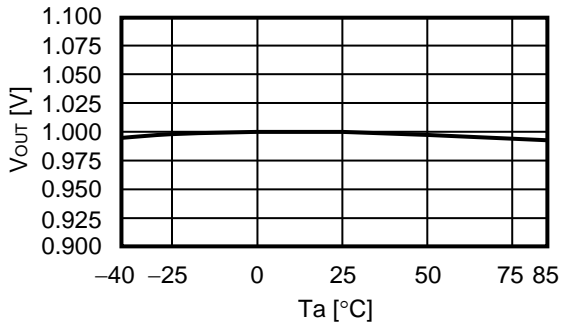

S-1172B30

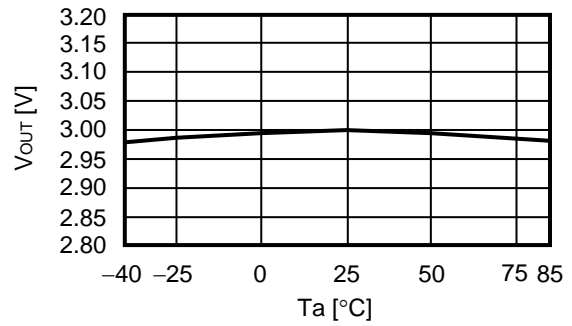

S-1172B50

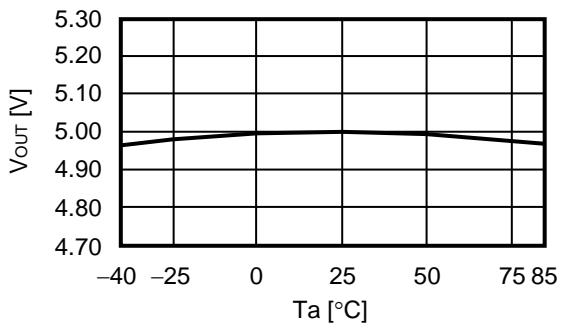

(6) Current Consumption vs. Input Voltage

S-1172B10

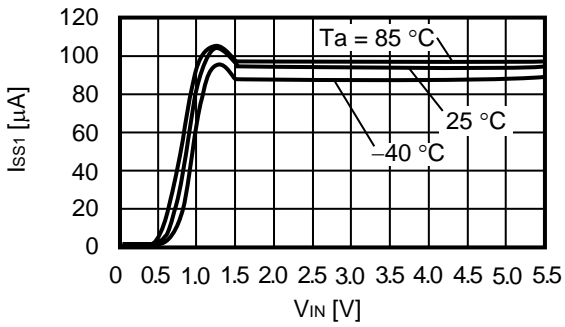

S-1172B30

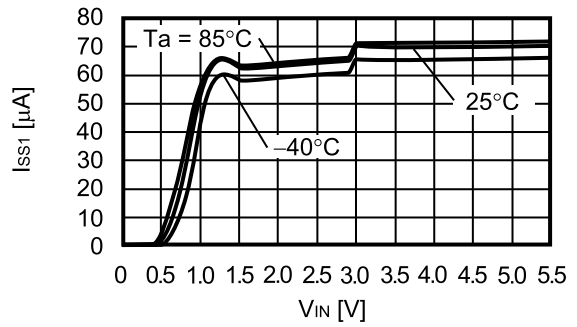

S-1172B50

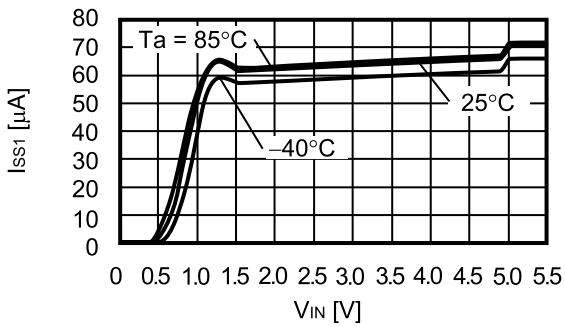

(7) Ripple Rejection ($T_a = 25^\circ\text{C}$)

S-1172B10

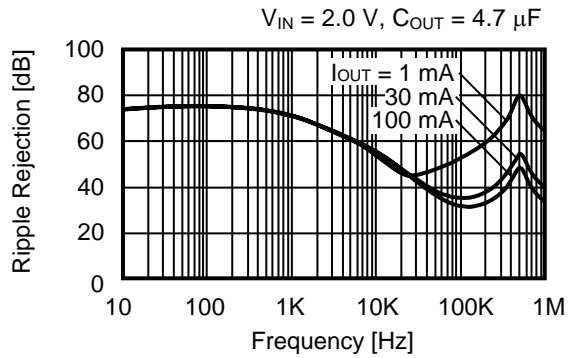

S-1172B30

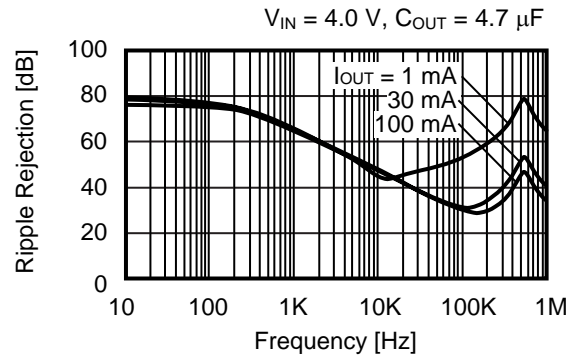

S-1172B50

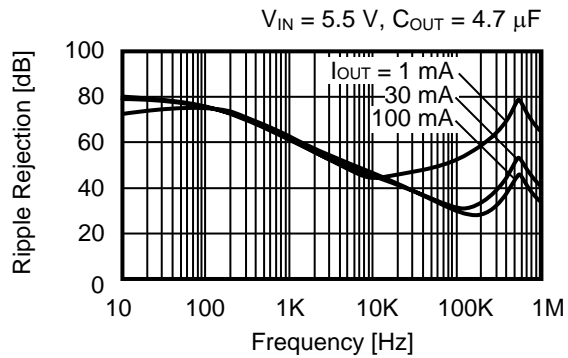

■ Reference Data

(1) Characteristics of Input Transient Response ($T_a = 25^\circ\text{C}$)

S-1172B10

$I_{OUT} = 100\text{ mA}$, $t_r = t_f = 5.0\ \mu\text{s}$, $C_{OUT} = 4.7\ \mu\text{F}$, $C_{IN} = 4.7\ \mu\text{F}$

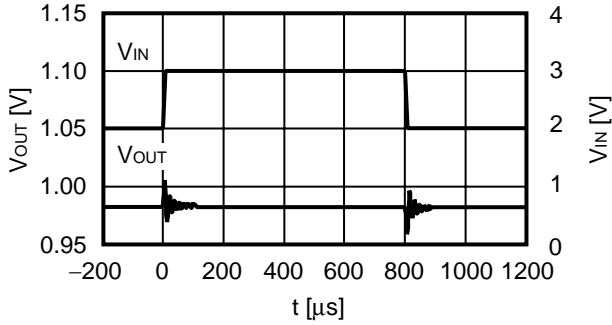

S-1172B30

$I_{OUT} = 100\text{ mA}$, $t_r = t_f = 5.0\ \mu\text{s}$, $C_{OUT} = 4.7\ \mu\text{F}$, $C_{IN} = 4.7\ \mu\text{F}$

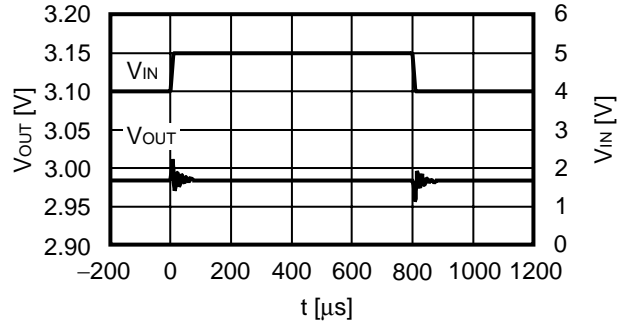

S-1172B50

$I_{OUT} = 100\text{ mA}$, $t_r = t_f = 5.0\ \mu\text{s}$, $C_{OUT} = 4.7\ \mu\text{F}$, $C_{IN} = 4.7\ \mu\text{F}$

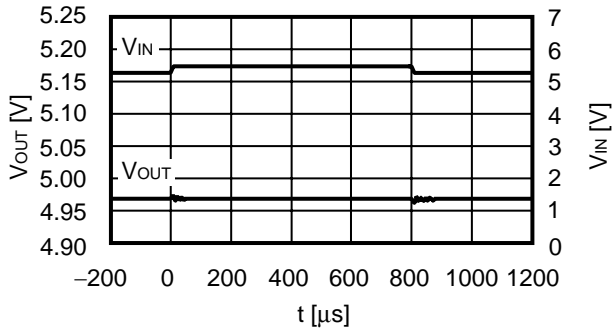

(2) Characteristics of Load Transient Response ($T_a = 25^\circ\text{C}$)

S-1172B10

$V_{IN} = 2.0\text{ V}$, $C_{OUT} = 4.7\ \mu\text{F}$, $C_{IN} = 4.7\ \mu\text{F}$, $I_{OUT} = 50 \leftrightarrow 100\text{ mA}$

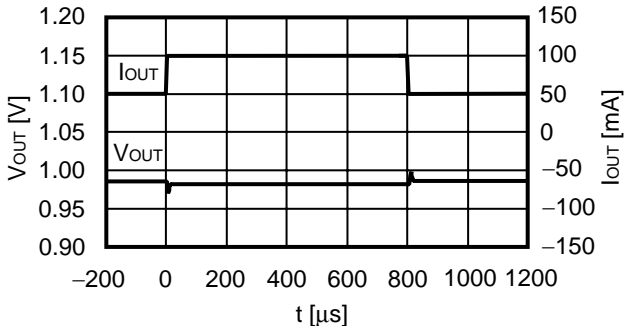

$V_{IN} = 2.0\text{ V}$, $C_{OUT} = 4.7\ \mu\text{F}$, $C_{IN} = 4.7\ \mu\text{F}$, $I_{OUT} = 100 \leftrightarrow 500\text{ mA}$

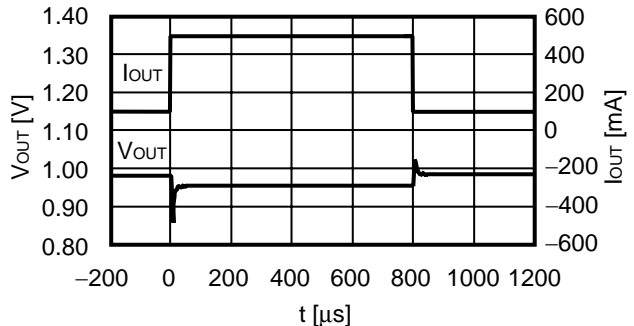

S-1172B30

$V_{IN} = 4.0\text{ V}$, $C_{OUT} = 4.7\ \mu\text{F}$, $C_{IN} = 4.7\ \mu\text{F}$, $I_{OUT} = 50 \leftrightarrow 100\text{ mA}$

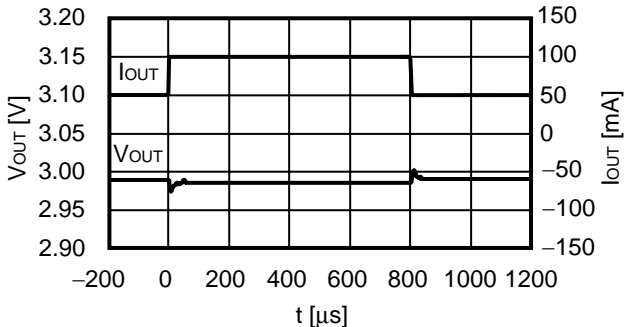

$V_{IN} = 4.0\text{ V}$, $C_{OUT} = 4.7\ \mu\text{F}$, $C_{IN} = 4.7\ \mu\text{F}$, $I_{OUT} = 100 \leftrightarrow 500\text{ mA}$

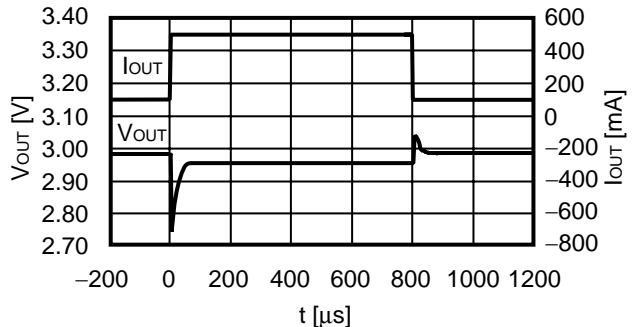

S-1172B50

$V_{IN} = 5.5\text{ V}$, $C_{OUT} = 4.7\ \mu\text{F}$, $C_{IN} = 4.7\ \mu\text{F}$, $I_{OUT} = 50 \leftrightarrow 100\text{ mA}$

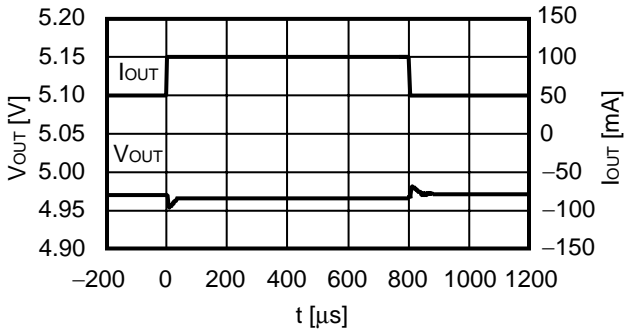

$V_{IN} = 5.5\text{ V}$, $C_{OUT} = 4.7\ \mu\text{F}$, $C_{IN} = 4.7\ \mu\text{F}$, $I_{OUT} = 100 \leftrightarrow 500\text{ mA}$

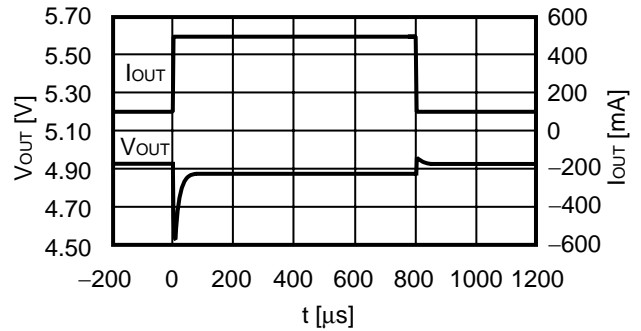

(3) Transient Response Characteristics of ON/OFF Pin ($T_a = 25^\circ\text{C}$)

S-1172B10

$V_{IN} = 2.0\text{ V}$, $C_{OUT} = 4.7\ \mu\text{F}$, $C_{IN} = 4.7\ \mu\text{F}$, $I_{OUT} = 100\text{ mA}$

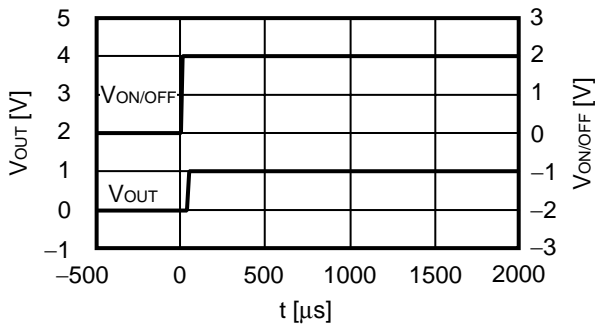

S-1172B30

$V_{IN} = 4.0\text{ V}$, $C_{OUT} = 4.7\ \mu\text{F}$, $C_{IN} = 4.7\ \mu\text{F}$, $I_{OUT} = 100\text{ mA}$

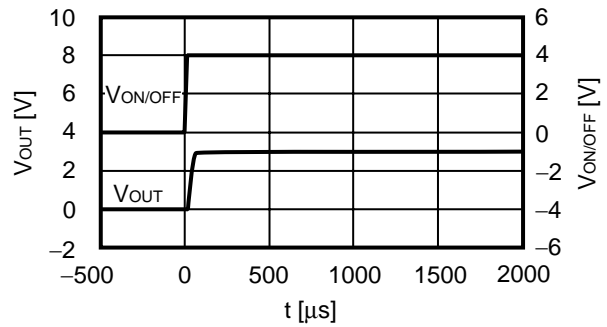

S-1172B50

$V_{IN} = 5.5\text{ V}$, $C_{OUT} = 4.7\ \mu\text{F}$, $C_{IN} = 4.7\ \mu\text{F}$, $I_{OUT} = 100\text{ mA}$

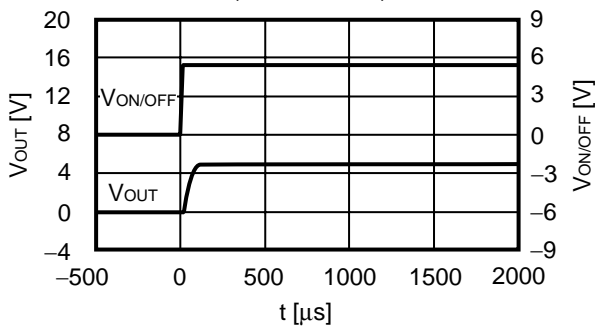

(4) Characteristics of Rush Current (Ta = 25°C)

S-1172B10

V_{IN} = 2.0 V, C_{OUT} = 4.7 μF, C_{IN} = 4.7 μF, I_{OUT} = 100 mA

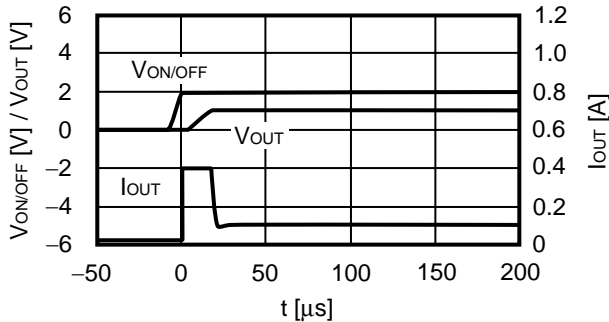

V_{IN} = 2.0 V, C_{OUT} = 4.7 μF, C_{IN} = 4.7 μF, I_{OUT} = 1000 mA

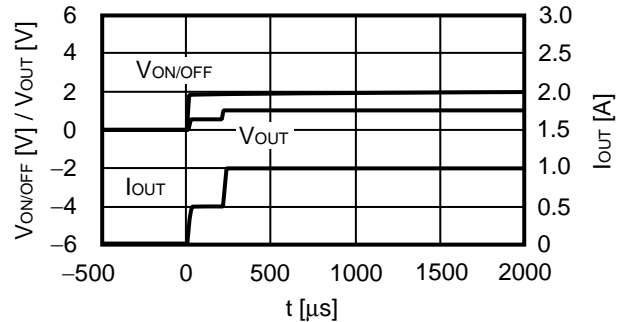

S-1172B30

V_{IN} = 4.0 V, C_{OUT} = 4.7 μF, C_{IN} = 4.7 μF, I_{OUT} = 100 mA

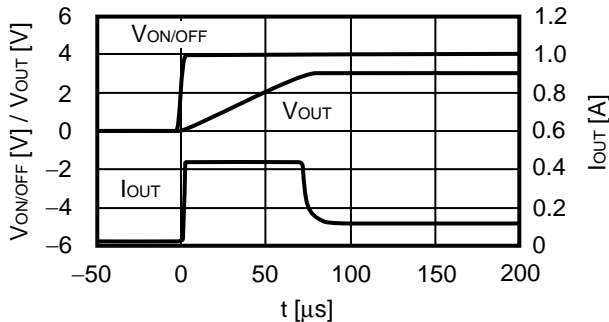

V_{IN} = 4.0 V, C_{OUT} = 4.7 μF, C_{IN} = 4.7 μF, I_{OUT} = 1000 mA

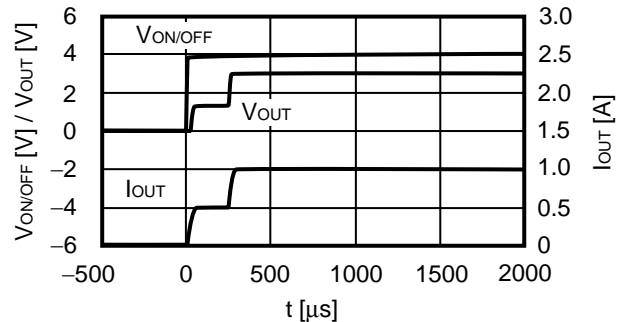

S-1172B50

V_{IN} = 5.5 V, C_{OUT} = 4.7 μF, C_{IN} = 4.7 μF, I_{OUT} = 100 mA

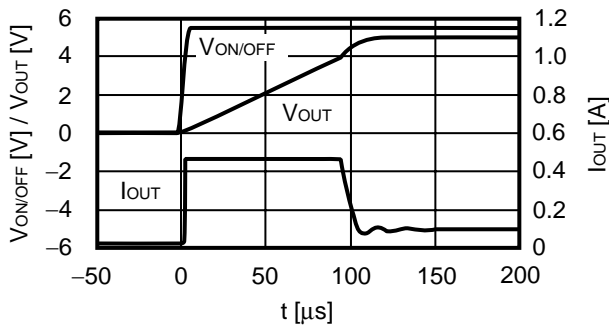

V_{IN} = 5.5 V, C_{OUT} = 4.7 μF, C_{IN} = 4.7 μF, I_{OUT} = 1000 mA

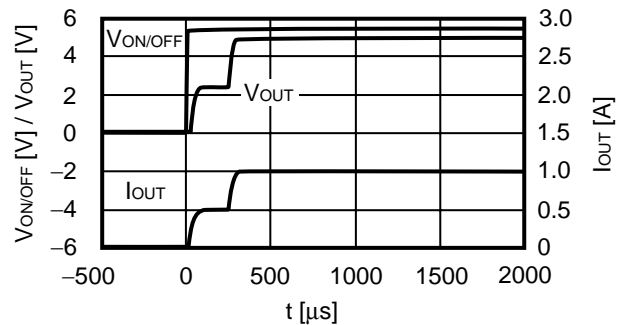

(5) Example of Equivalent Series Resistance vs. Output Current Characteristics (Ta = 25°C)

C_L : Taiyo Yuden LMK316BJ475ML (4.7 μF)

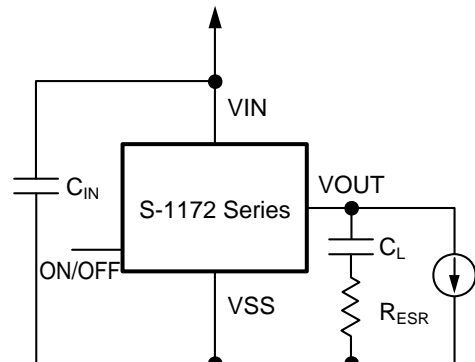
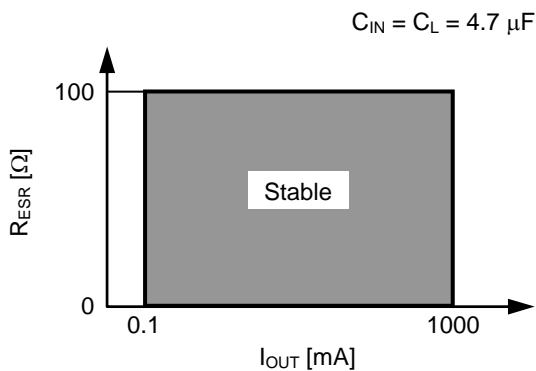

■ Marking Specifications

(1) SOT-89-5

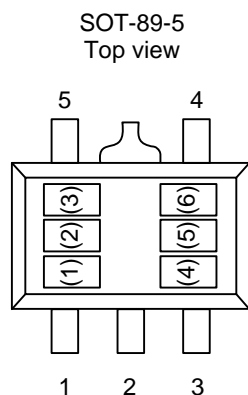

(1) to (3) : Product abbreviation (refer to **Product Name vs. Product Code**)
 (4) to (6) : Lot number

Product Name vs. Product Code

Product Name	Product Code		
	(1)	(2)	(3)
S-1172B10-U5T1x	S	O	A
S-1172B11-U5T1x	S	O	B
S-1172B12-U5T1x	S	O	C
S-1172B1C-U5T1x	S	P	S
S-1172B13-U5T1x	S	O	D
S-1172B14-U5T1x	S	O	E
S-1172B15-U5T1x	S	O	F
S-1172B16-U5T1x	S	O	G
S-1172B17-U5T1x	S	O	H
S-1172B18-U5T1x	S	O	I
S-1172B1J-U5T1x	S	O	J
S-1172B19-U5T1x	S	O	K
S-1172B20-U5T1x	S	O	L
S-1172B21-U5T1x	S	O	M
S-1172B22-U5T1x	S	O	N
S-1172B23-U5T1x	S	O	O
S-1172B24-U5T1x	S	O	P
S-1172B25-U5T1x	S	O	Q
S-1172B26-U5T1x	S	O	R
S-1172B27-U5T1x	S	O	S
S-1172B28-U5T1x	S	O	T
S-1172B2J-U5T1x	S	O	U

Product Name	Product Code		
	(1)	(2)	(3)
S-1172B29-U5T1x	S	O	V
S-1172B30-U5T1x	S	O	W
S-1172B31-U5T1x	S	O	X
S-1172B32-U5T1x	S	O	Y
S-1172B33-U5T1x	S	O	Z
S-1172B34-U5T1x	S	P	A
S-1172B35-U5T1x	S	P	B
S-1172B36-U5T1x	S	P	C
S-1172B37-U5T1x	S	P	D
S-1172B38-U5T1x	S	P	E
S-1172B39-U5T1x	S	P	F
S-1172B40-U5T1x	S	P	G
S-1172B41-U5T1x	S	P	H
S-1172B42-U5T1x	S	P	I
S-1172B43-U5T1x	S	P	J
S-1172B44-U5T1x	S	P	K
S-1172B45-U5T1x	S	P	L
S-1172B46-U5T1x	S	P	M
S-1172B47-U5T1x	S	P	N
S-1172B48-U5T1x	S	P	O
S-1172B49-U5T1x	S	P	P
S-1172B50-U5T1x	S	P	Q

- Remark 1.** Please contact our sales office for products with an output voltage other than those specified above or type A products.
2. x: G or U
 3. Please select products of environmental code = U for Sn 100%, halogen-free products.

(2) HSOP-6

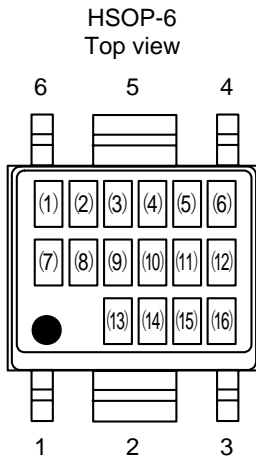

- (1) to (5) : Product name : S1172 (Fixed)
- (6) : Product type
- (7) and (8) : Value of output voltage
- (9) : Blank
- (10) to (16) : Lot number

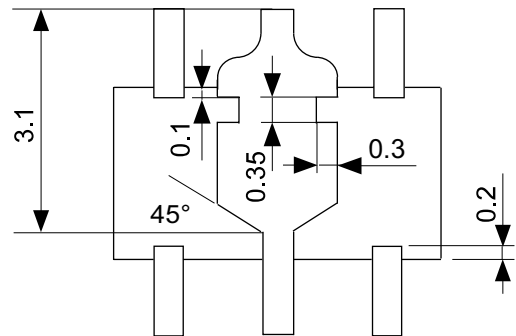
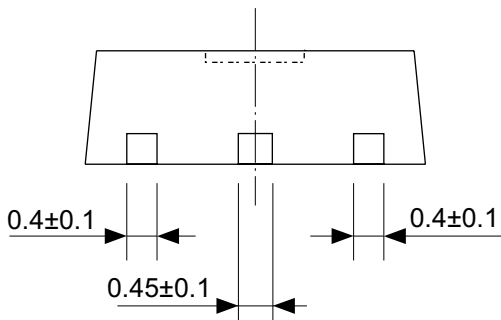
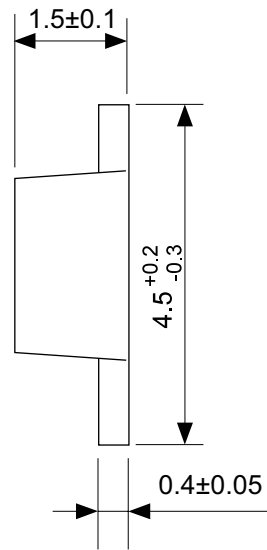
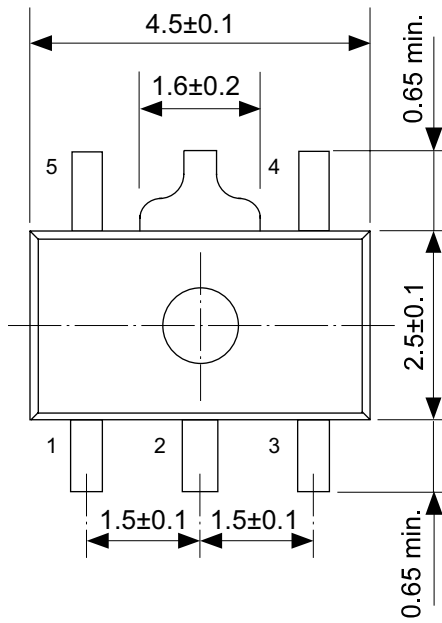

No. UP005-A-P-SD-1.1

TITLE	SOT895-A-PKG Dimensions
No.	UP005-A-P-SD-1.1
SCALE	
UNIT	mm
Seiko Instruments Inc.	

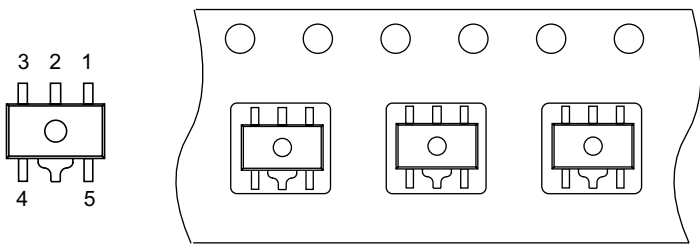
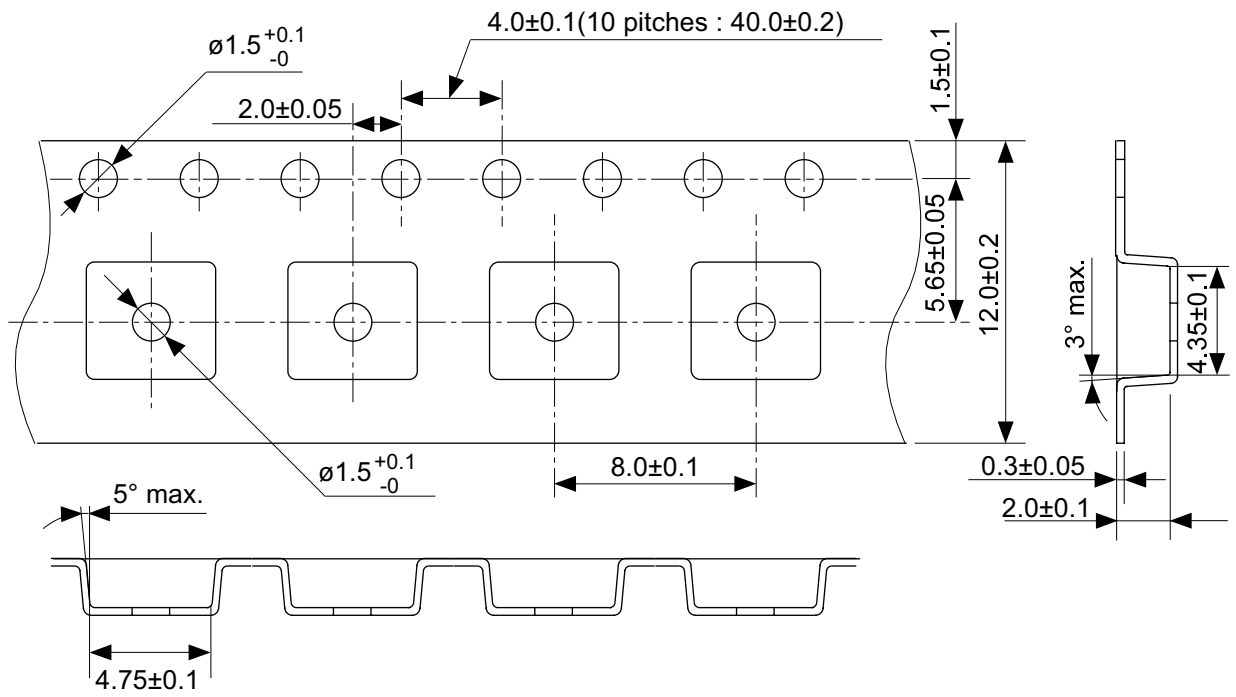

→
Feed direction

No. UP005-A-C-SD-1.1

TITLE	SOT895-A-Carrier Tape
No.	UP005-A-C-SD-1.1
SCALE	
UNIT	mm

Seiko Instruments Inc.

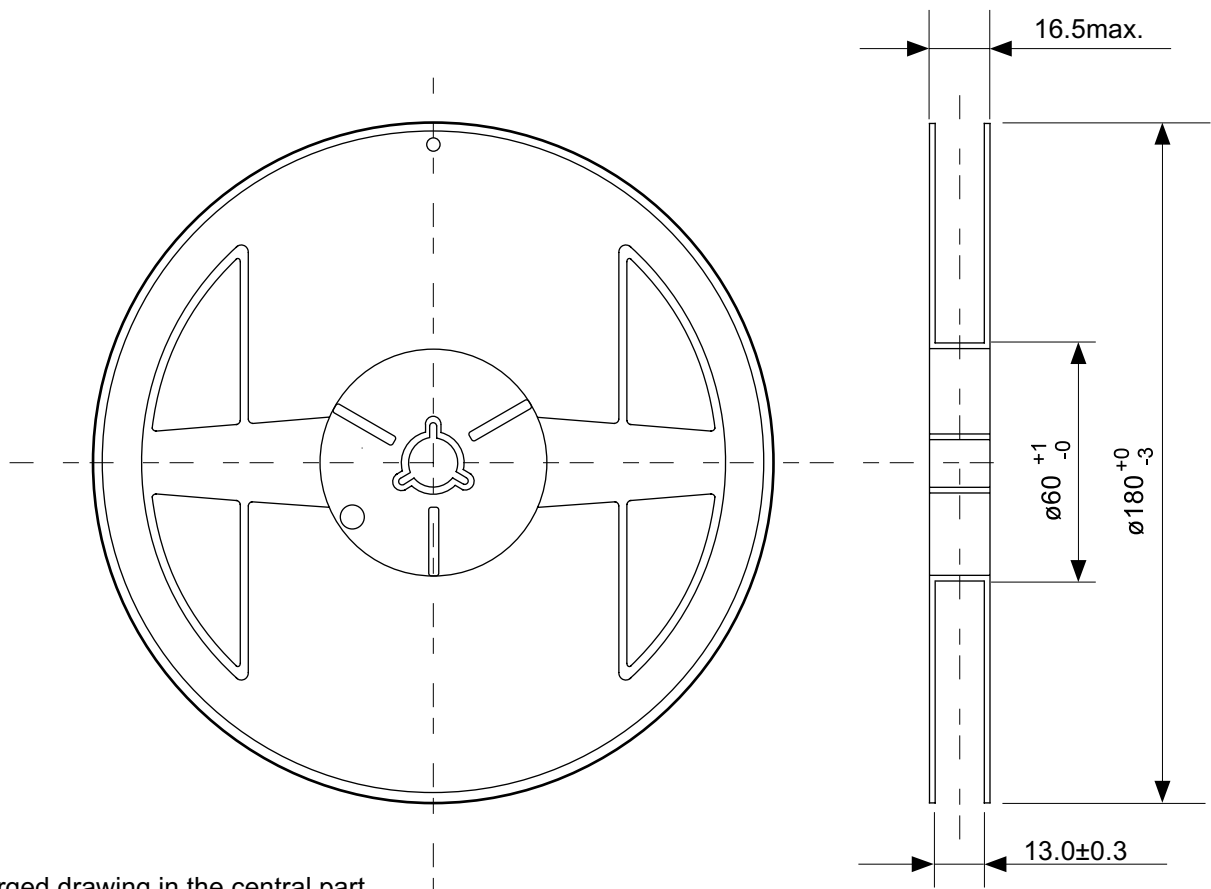

Enlarged drawing in the central part

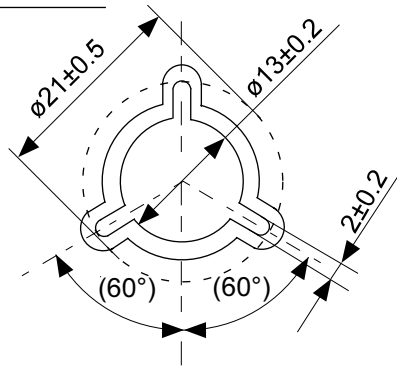

No. UP005-A-R-SD-1.1

TITLE	SOT895-A-Reel		
No.	UP005-A-R-SD-1.1		
SCALE		QTY.	1,000
UNIT	mm		
Seiko Instruments Inc.			

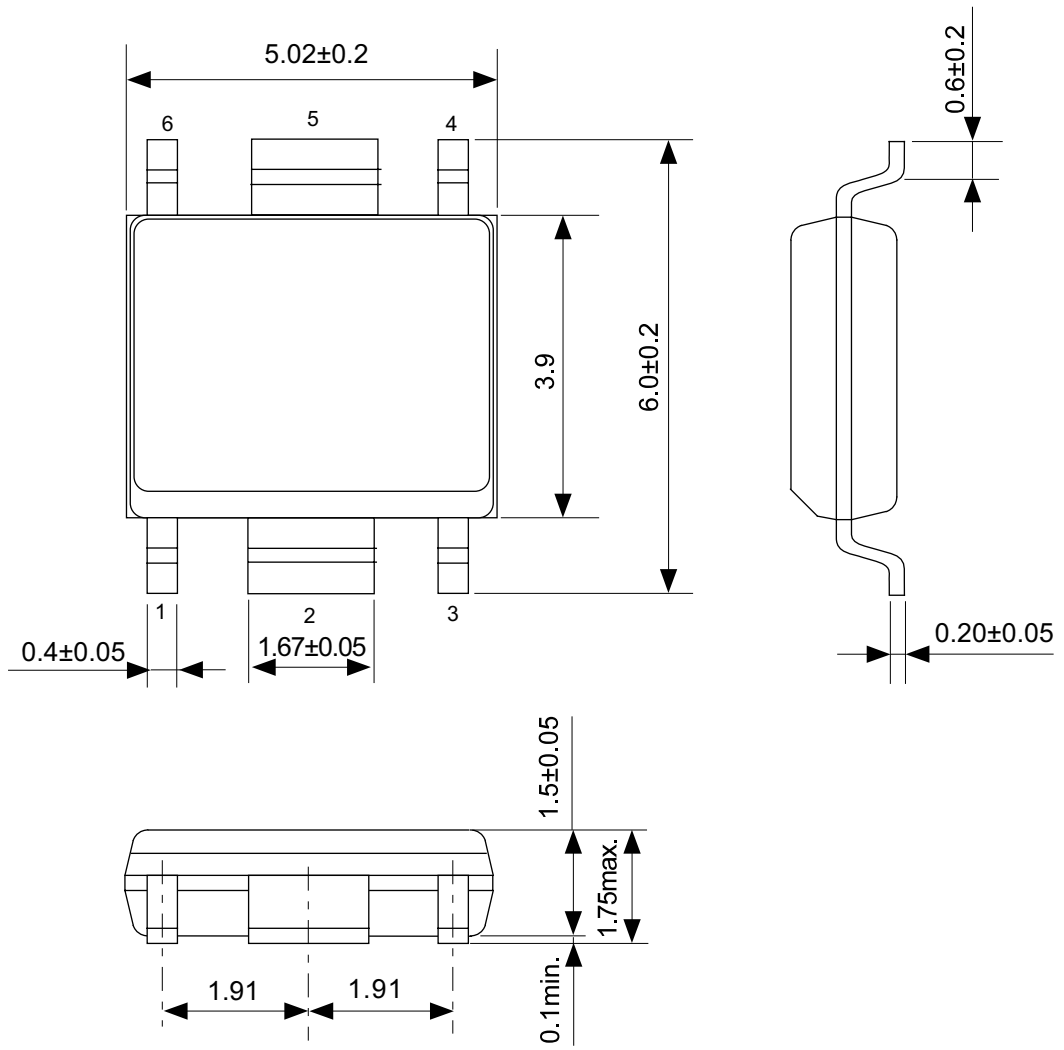

No. FH006-A-P-SD-2.0

TITLE	HSOP6-A-PKG Dimensions
No.	FH006-A-P-SD-2.0
SCALE	
UNIT	mm
Seiko Instruments Inc.	

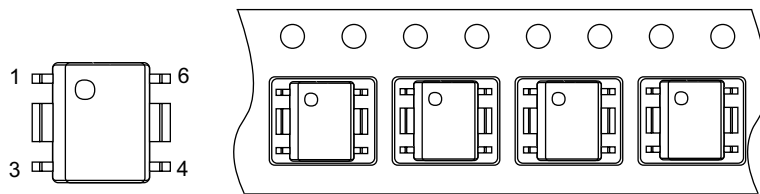
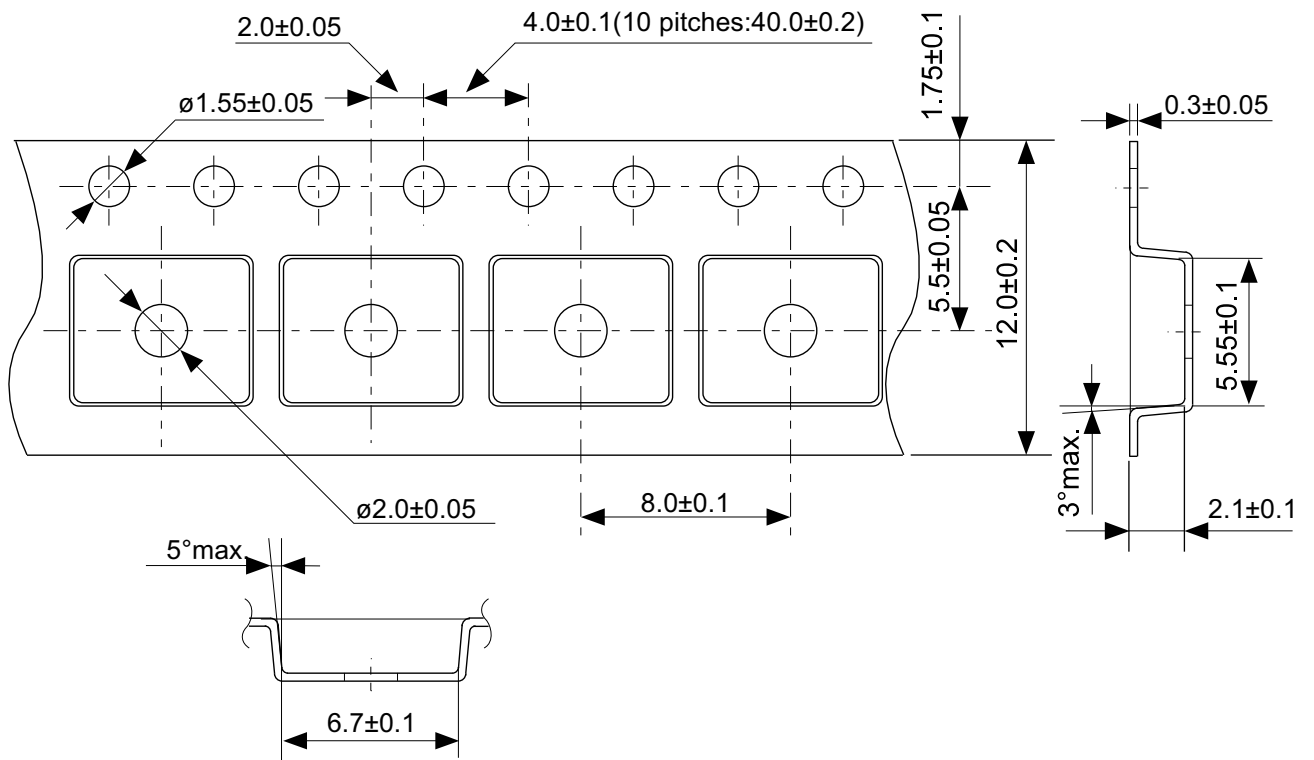

No. FH006-A-C-SD-1.0

TITLE	HSOP6-A-Carrier Tape
No.	FH006-A-C-SD-1.0
SCALE	
UNIT	mm
Seiko Instruments Inc.	

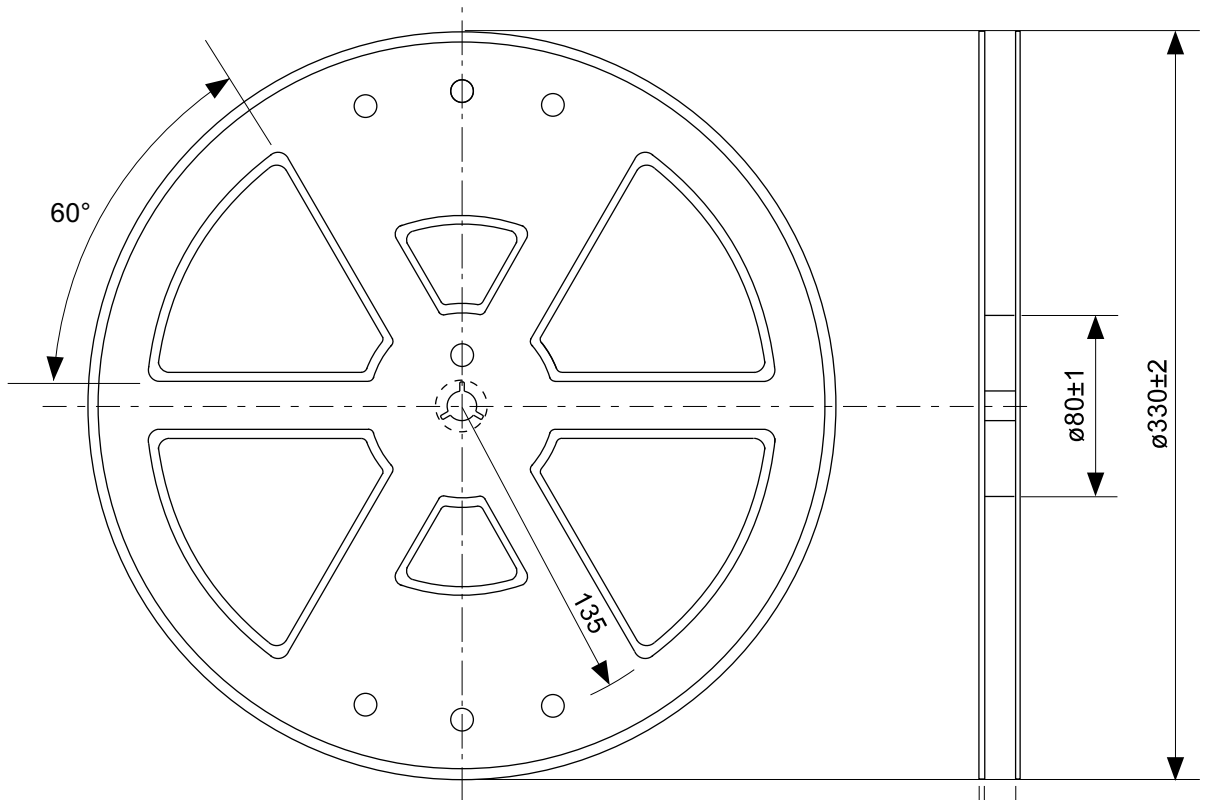

Enlarged drawing in the central part

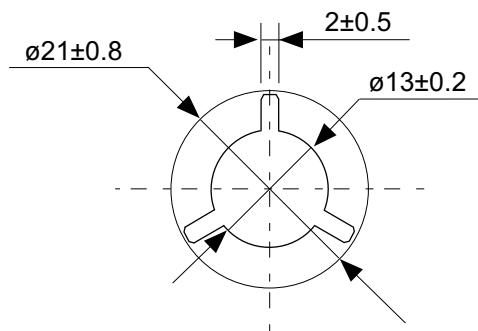
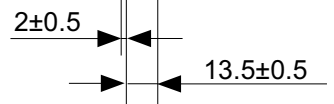

No. FH006-A-R-SD-1.0

TITLE	HSOP6-A-Reel		
No.	FH006-A-R-SD-1.0		
SCALE		QTY.	2,000
UNIT	mm		
Seiko Instruments Inc.			

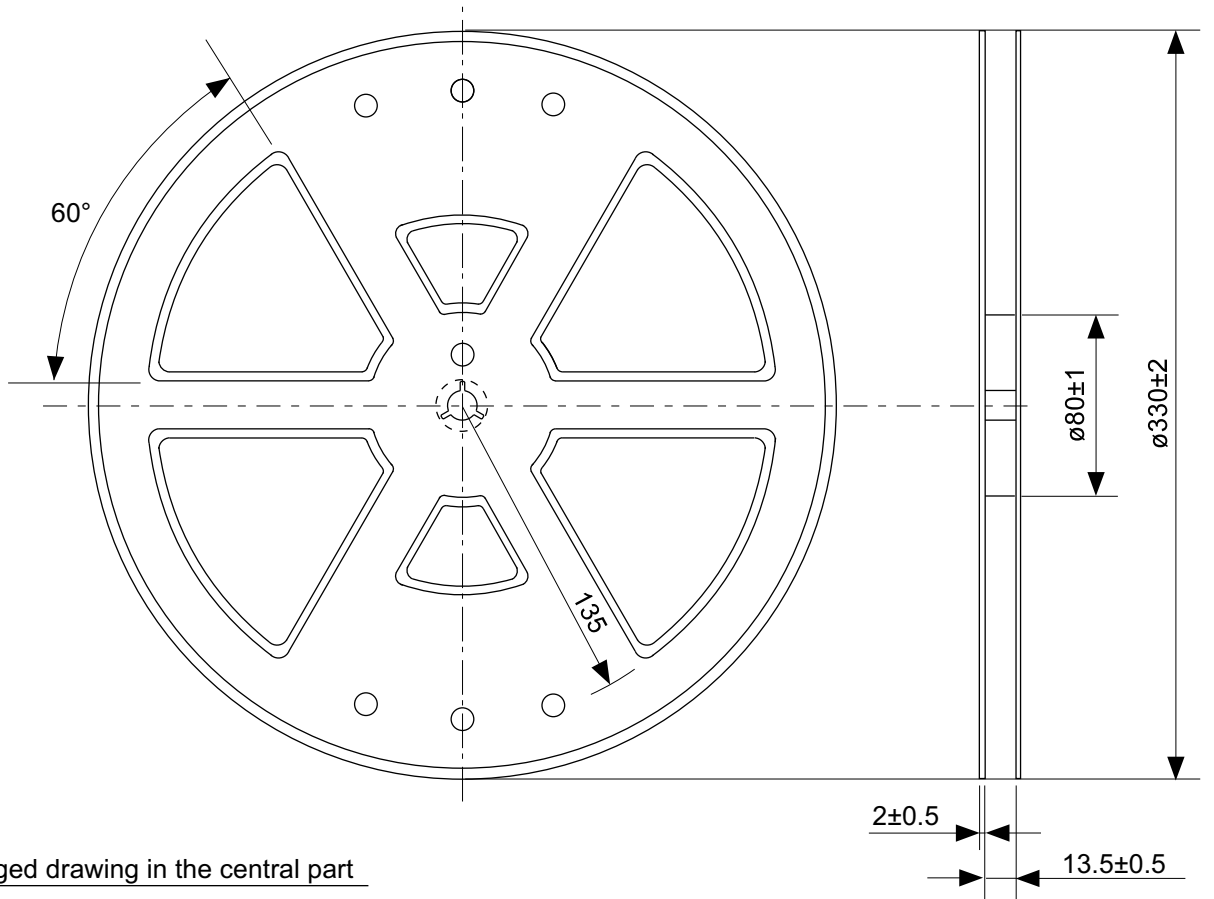

Enlarged drawing in the central part

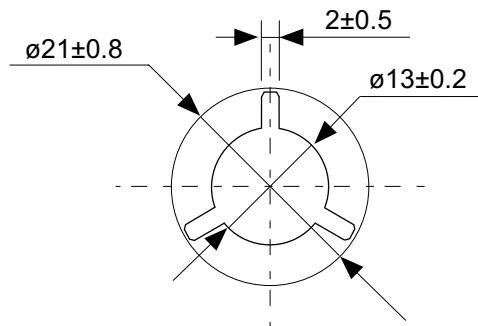

No. FH006-A-R-S1-1.0

TITLE	HSOP6-A-Reel		
No.	FH006-A-R-S1-1.0		
SCALE		QTY.	4,000
UNIT	mm		
Seiko Instruments Inc.			

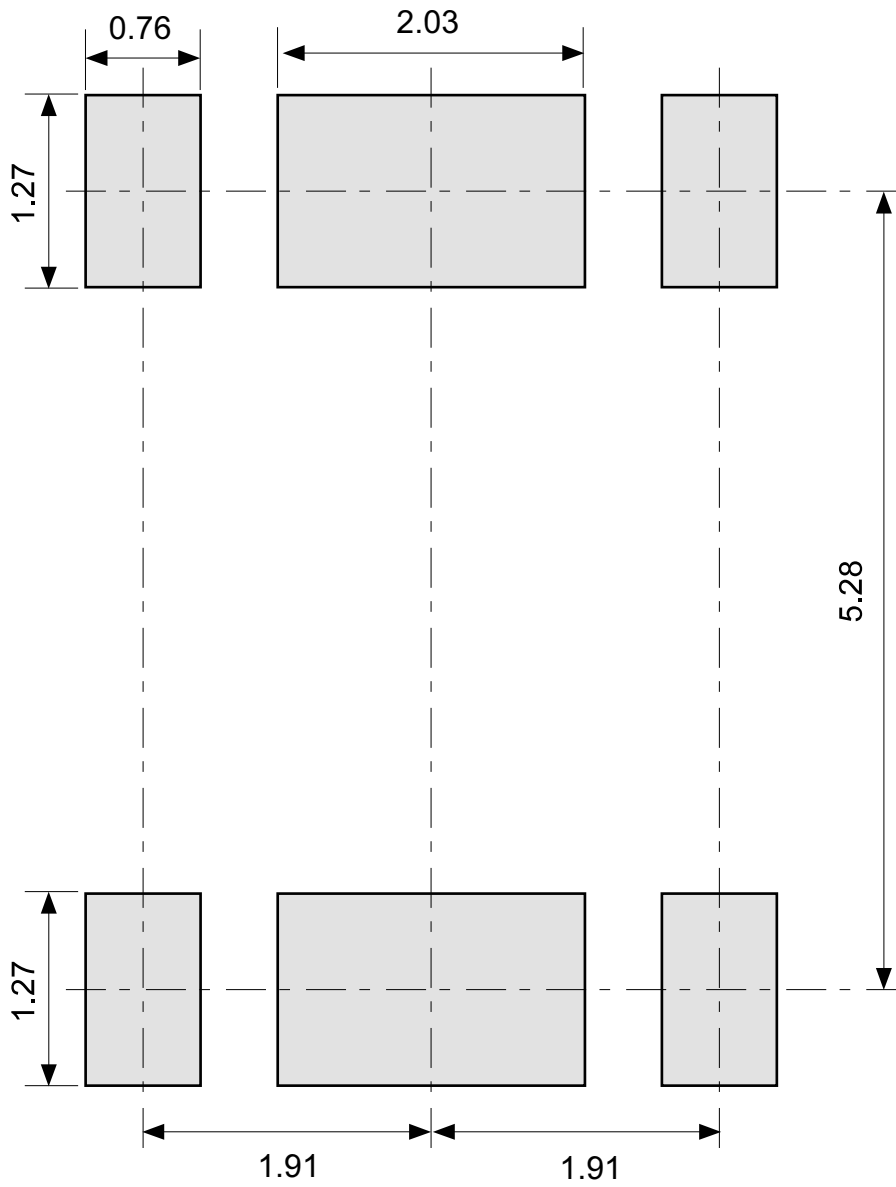

No. FH006-A-L-SD-2.0

TITLE	HSOP6-A-Land Recommendation
No.	FH006-A-L-SD-2.0
SCALE	
UNIT	mm
Seiko Instruments Inc.	



Seiko Instruments Inc.
www.sii-ic.com

- The information described herein is subject to change without notice.
- Seiko Instruments Inc. is not responsible for any problems caused by circuits or diagrams described herein whose related industrial properties, patents, or other rights belong to third parties. The application circuit examples explain typical applications of the products, and do not guarantee the success of any specific mass-production design.
- When the products described herein are regulated products subject to the Wassenaar Arrangement or other agreements, they may not be exported without authorization from the appropriate governmental authority.
- Use of the information described herein for other purposes and/or reproduction or copying without the express permission of Seiko Instruments Inc. is strictly prohibited.
- The products described herein cannot be used as part of any device or equipment affecting the human body, such as exercise equipment, medical equipment, security systems, gas equipment, or any apparatus installed in airplanes and other vehicles, without prior written permission of Seiko Instruments Inc.
- Although Seiko Instruments Inc. exerts the greatest possible effort to ensure high quality and reliability, the failure or malfunction of semiconductor products may occur. The user of these products should therefore give thorough consideration to safety design, including redundancy, fire-prevention measures, and malfunction prevention, to prevent any accidents, fires, or community damage that may ensue.