

## 5A Low Dropout Positive Voltage Regulator

TO-220



TO-263 (D<sup>2</sup>PAK)



TO-252 (DPAK)



**Pin Definition:**

- 1. Fixed / Adj
- 2. Output
- 3. Input
- Pin 2 connect to heat sink

### General Description

The TS1084 Series are high performance positive voltage regulators are designed for use in applications requiring low dropout performance at full rated current, Additionally, the TS1084 Series provides excellent regulation over variations due to changes in line, load and temperature. Outstanding features include low dropout performance at rated current, fast transient response, internal current limiting and thermal shutdown protection of the output device. The TS1084 Series are three terminal regulators with fixed and adjustable voltage options available in popular packages.

### Features

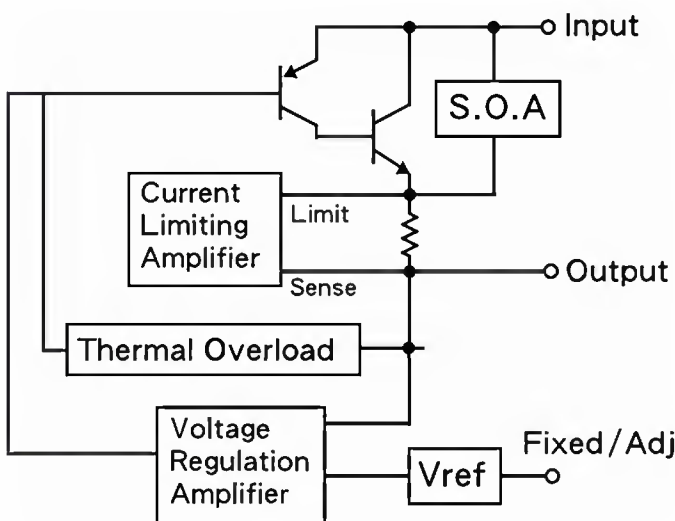
- Low Dropout Performance 1.5V max.
- Full Current Rating Over Line and Temperature
- Fast Transient Response
- ±2% Total Output Regulation Over Line, Load and Temperature
- Adjust Pin Current max 90uA Over Temperature
- Line Regulation Typical 0.015%
- Load Regulation Typical 0.05%
- Fixed / Adjustable Output Voltage
- TO-220, TO-263 and TO-252 Package

### Ordering Information

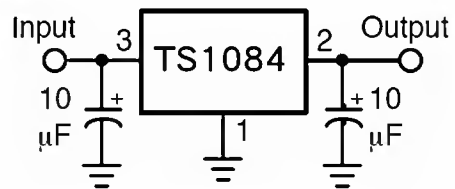
Part No.	Package	Packing
TS1084CZxx C0	TO-220	50pcs / Tube
TS1084CMxx RN	TO-263	800pcs / 13" Reel
TS1084CPxx RO	TO-252	2.5Kpcs / 13" Reel

Note: Where **xx** denotes voltage option, available are 5.0V, 3.3V, 2.5V and 1.8V. Leave blank for adjustable version. Contact factory for additional voltage options.

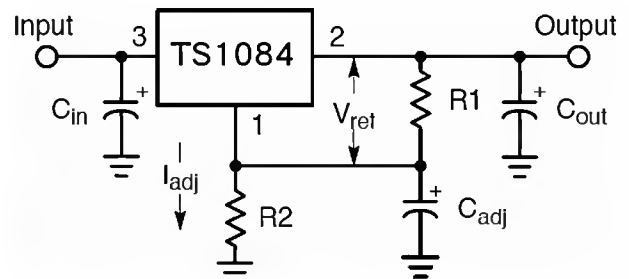
### Block Diagram



### Typical Application Circuit



#### Fixed Output Voltage Version



$$V_{OUT} = V_{REF}(1+R2/R1) + I_{adj} R2$$

**Adjustable Output Voltage Version**

### Absolute Maximum Rating (Note 1)

Parameter	Symbol	Limit	Unit
Input Supply Voltage	$V_{IN}$	12	V
Operation Input Supply Voltage	$V_{IN}$ (Opr. Typ.)	7	V
Power Dissipation (Note 2)	$P_D$	Internal limited	
Thermal Resistance Junction to Ambient	TO-220	80	°C/W
	TO-263	85	
	TO-252	105	
Operating Junction Temperature Range	$T_J$	0 ~ +125	°C
Storage Temperature Range	$T_{STG}$	-65 ~ +150	°C
Lead Soldering Temperature (260°C)	TO-220 / TO-263	10	S
	TO-252	5	

### Electrical Specification ( $T_a = 25^\circ\text{C}$ , unless otherwise specified.)

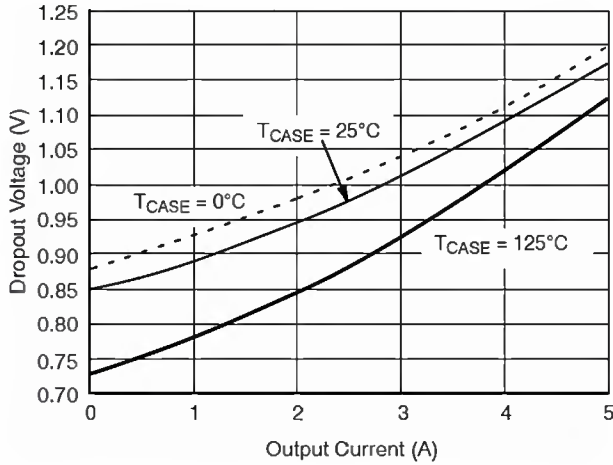
Parameter	Conditions	Min	Typ	Max	Unit
Reference Voltage	$V_{IN} = 2.75, I_o = 5$	1.225	1.25	1.275	V
Output Voltage	$V_{IN} = 3.3\text{V} \sim 7\text{V}, I_o = 5\text{A}$	1.764	1.8	1.836	V
	$V_{IN} = 4\text{V} \sim 7\text{V}, I_o = 5\text{A}$	2.450	2.5	2.550	V
	$V_{IN} = 4.8\text{V} \sim 7\text{V}, I_o = 5\text{A}$	3.235	3.3	3.366	V
	$V_{IN} = 6.5\text{V} \sim 7\text{V}, I_o = 5\text{A}$	4.900	5.0	5.100	V
Line Regulation	$V_o + 1.5\text{V} \leq V_{IN} \leq 7\text{V}, I_o = 10\text{mA}$	--	0.015	0.2	%
Load Regulation (Note 1,2)	$V_{IN} = V_{OUT} + 1.5\text{V}$ $I_o = 10\text{mA} \sim 5\text{A}$	--	0.05	1.0	%
Dropout Voltage	$I_o = 1\text{A}, \Delta V_{OUT} = 1\% V_{OUT}$	--	1.3	1.5	V
Quiescent Current	$V_{IN} = 5\text{V}$	--	8	10	mA
Adjustable Pin Current		--	90	--	uA
Output Current Limit	$V_{IN} - V_{OUT} = 3\text{V}$	2.0	--	--	A
Temperature Stability	$I_o = 10\text{mA}$ ,	--	0.5	--	%
Ripple Rejection	$F = 120\text{Hz}, I_o = 1\text{A}, C_{OUT} = 25\mu\text{F},$ $V_{IN} = V_{out} + 3\text{V}$	--	60	70	dB

Note 1: See thermal regulation specification for changes in output voltage due to heating effects. Line and load regulation are measured at a constant junction temperature by low duty cycle pulse testing. Load regulation is measured at the output lead = 1/18" from the package.

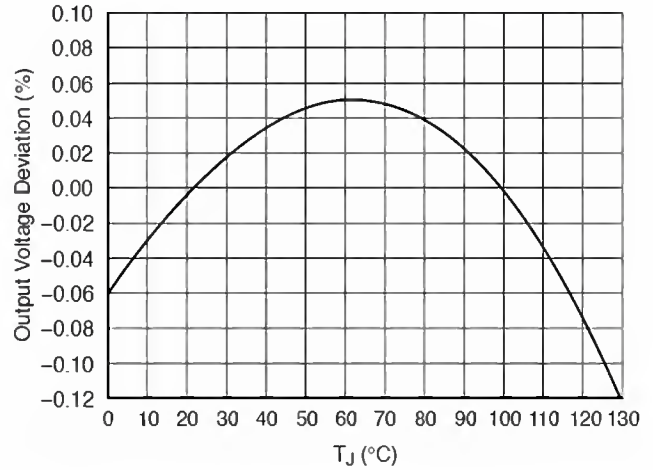
Note 2: Line and load regulation are guaranteed up to the maximum power dissipation of 15W. Power dissipation is determined by the input / output voltage difference and the output current. Guaranteed maximum power dissipation will not be available over the full input / output voltage range.

Note 3: Quiescent current is defined as the minimum output current required to maintain the regulation.

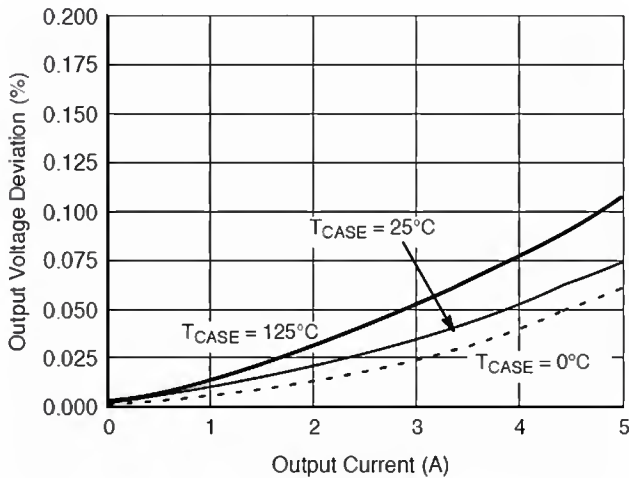
**Electrical Characteristics Curve**



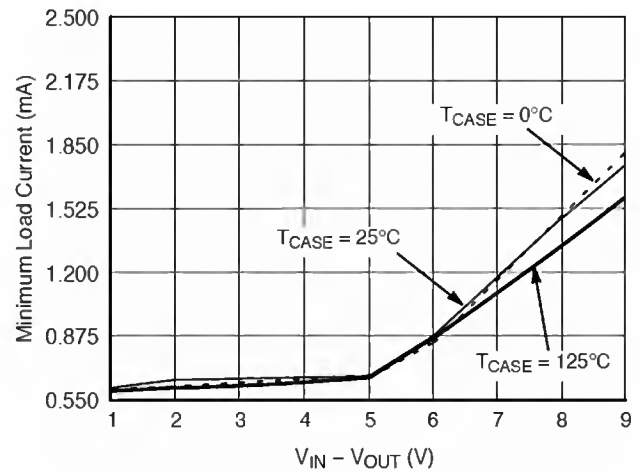
**Figure 1. Vdrop vs. Output Current**



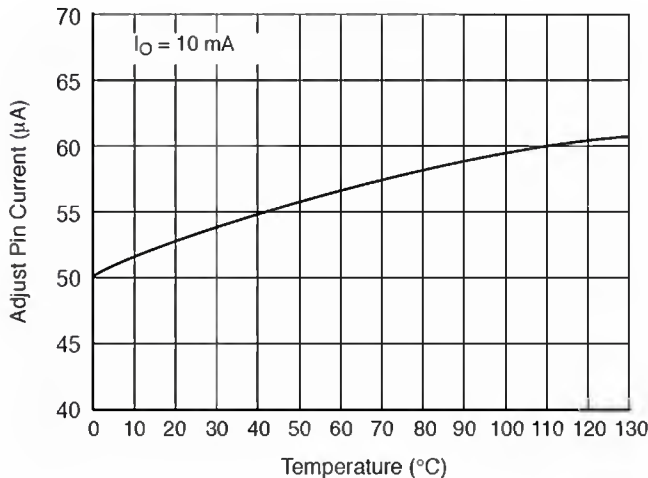
**Figure 2. Reference Voltage vs. Temperature**



**Figure 3. Load Regulation vs. Output Current**

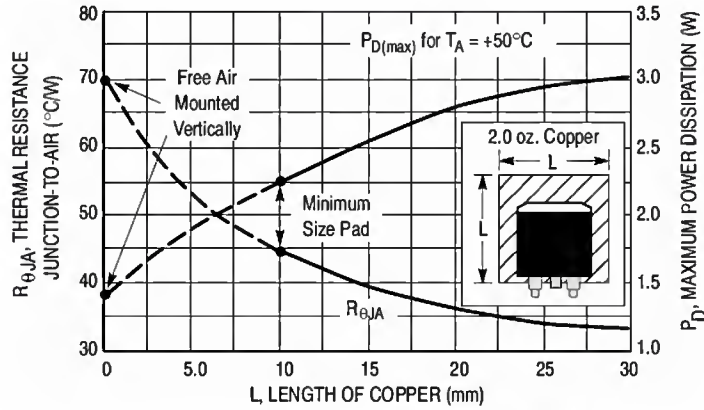


**Figure 4. Minimum Load Current**

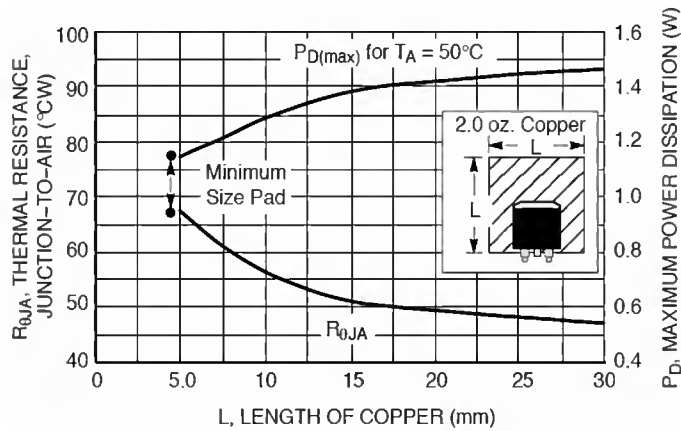


**Figure 5. Iadj Pin vs. Temperature**

**Application Information**

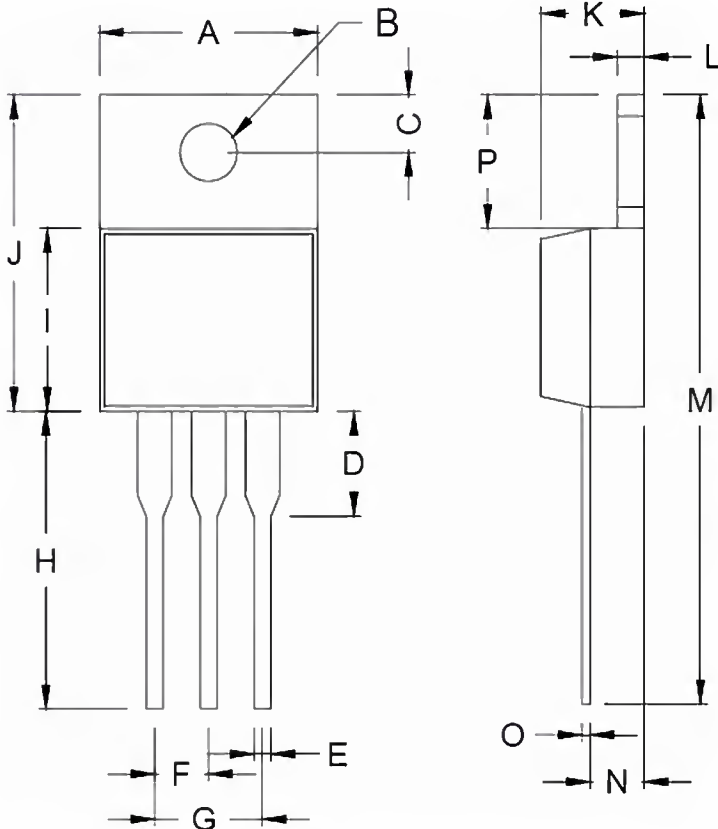


**FIGURE 6 – D<sup>2</sup>PAK Thermal Resistance and Maximum Power Dissipation vs. P.C.B Copper Length**



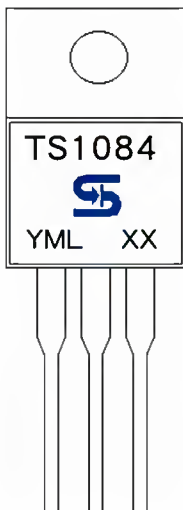
**Figure 7 – DPAK Thermal Resistance and Maximum Power Dissipation vs. P.C.B Copper Length**

**TO-220 Mechanical Drawing**



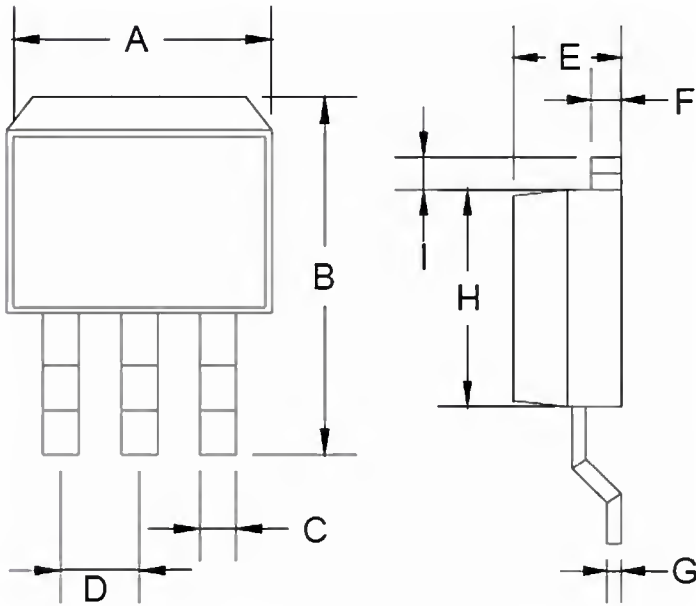
TO-220 DIMENSION				
DIM	MILLIMETERS		INCHES	
	MIN	MAX	MIN	MAX
A	10.000	10.500	0.394	0.413
B	3.740	3.910	0.147	0.154
C	2.440	2.940	0.096	0.116
D	-	6.350	-	0.250
E	0.381	1.106	0.015	0.040
F	2.345	2.715	0.092	0.058
G	4.690	5.430	0.092	0.107
H	12.700	14.732	0.500	0.581
I	8.382	9.017	0.330	0.355
J	14.224	16.510	0.560	0.650
K	3.556	4.826	0.140	0.190
L	0.508	1.397	0.020	0.055
M	27.700	29.620	1.060	1.230
N	2.032	2.921	0.080	0.115
O	0.255	0.610	0.010	0.024
P	5.842	6.858	0.230	0.270

**Marking Diagram**



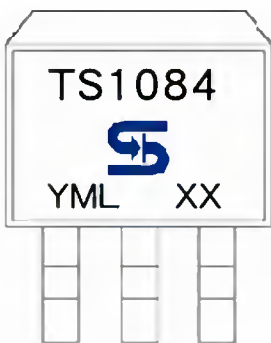
- Y** = Year Code
- M** = Month Code  
(A=Jan, B=Feb, C=Mar, D=Apl, E=May, F=Jun, G=Jul, H=Aug, I=Sep, J=Oct, K=Nov, L=Dec)
- L** = Lot Code
- XX** = Voltage Code  
(1.8=1.8V, 2.5=2.5V, 3.3=3.3V, 5.0=5V)
- = Package Code for Adjustable type  
(CZ = TO-220)

**TO-263 Mechanical Drawing**



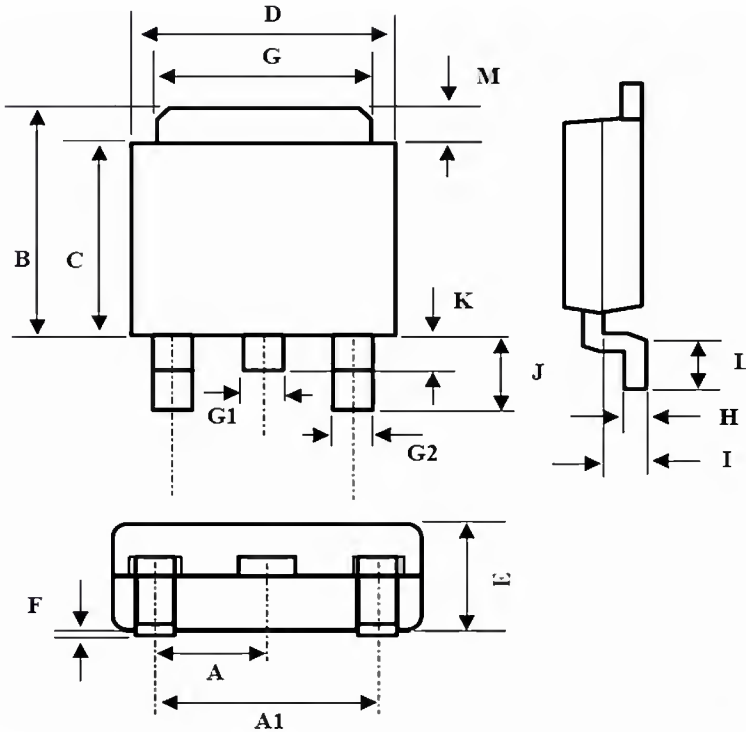
DIM	TO-263 DIMENSION			
	MILLIMETERS		INCHES	
	MIN	MAX	MIN	MAX
A	10.000	10.500	0.394	0.413
B	14.605	15.875	0.575	0.625
C	0.508	0.991	0.020	0.039
D	2.420	2.660	0.095	0.105
E	4.064	4.830	0.160	0.190
F	1.118	1.400	0.045	0.055
G	0.450	0.730	0.018	0.029
H	8.280	8.800	0.325	0.346
I	1.140	1.400	0.044	0.055
J	1.480	1.520	0.058	0.060

**Marking Diagram**



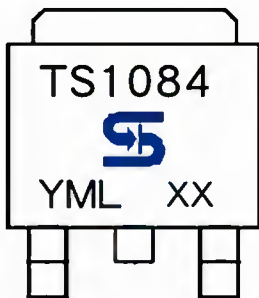
- Y** = Year Code
- M** = Month Code  
(A=Jan, B=Feb, C=Mar, D=Apl, E=May, F=Jun, G=Jul, H=Aug, I=Sep, J=Oct, K=Nov, L=Dec)
- L** = Lot Code
- XX** = Voltage Code  
(1.8=1.8V, 2.5=2.5V, 3.3=3.3V, 5.0=5V)  
= Package Code for Adjustable type  
(CM = TO-263)

**TO-252 Mechanical Drawing**



TO-252 DIMENSION				
DIM	MILLIMETERS		INCHES	
	MIN	MAX	MIN	MAX
A	2.3BSC		0.09BSC	
A1	4.6BSC		0.18BSC	
B	6.80	7.20	0.268	0.283
C	5.40	5.60	0.213	0.220
D	6.40	6.65	0.252	0.262
E	2.20	2.40	0.087	0.094
F	0.00	0.20	0.000	0.008
G	5.20	5.40	0.205	0.213
G1	0.75	0.85	0.030	0.033
G2	0.55	0.65	0.022	0.026
H	0.35	0.65	0.014	0.026
I	0.90	1.50	0.035	0.059
J	2.20	2.80	0.087	0.110
K	0.50	1.10	0.020	0.043
L	0.90	1.50	0.035	0.059
M	1.30	1.70	0.051	0.67

**Marking Diagram**



- Y** = Year Code
- M** = Month Code  
(A=Jan, B=Feb, C=Mar, D=Apr, E=May, F=Jun, G=Jul, H=Aug, I=Sep, J=Oct, K=Nov, L=Dec)
- L** = Lot Code
- XX** = Voltage Code  
(1.8=1.8V, 2.5=2.5V, 3.3=3.3V, 5.0=5V)
- = Package Code for Adjustable type  
(CP = TO-252)

### Notice

Specifications of the products displayed herein are subject to change without notice. TSC or anyone on its behalf, assumes no responsibility or liability for any errors or inaccuracies.

Information contained herein is intended to provide a product description only. No license, express or implied, to any intellectual property rights is granted by this document. Except as provided in TSC's terms and conditions of sale for such products, TSC assumes no liability whatsoever, and disclaims any express or implied warranty, relating to sale and/or use of TSC products including liability or warranties relating to fitness for a particular purpose, merchantability, or infringement of any patent, copyright, or other intellectual property right.

The products shown herein are not designed for use in medical, life-saving, or life-sustaining applications. Customers using or selling these products for use in such applications do so at their own risk and agree to fully indemnify TSC for any damages resulting from such improper use or sale.