



- Features :
 - Universal AC input / Full range
 - Built-in active PFC function
 - High efficiency up to 94%
 - Protections: Short circuit / Overload / Over voltage / Over temperature
 - Cooling by free air convection
 - OCP point adjustable through output cable or internal potential meter
 - IP67 / IP65 design for indoor or outdoor installations
 - Three in one dimming function (1~10Vdc or PWM signal or resistor)
 - Suitable for LED lighting and street lighting applications
 - Compliance to worldwide safety regulations for lighting
 - Suitable for dry / damp / wet locations
 - 5 years warranty (Note.10)



HLG-150-12 [A] Blank : IP67 rated. Cable for I/O connection.
 A : IP65 rated. Output voltage and constant current level can be adjusted through internal potential meter.
 B : IP67 rated. Constant current level adjustable through output cable with 1~10Vdc or 10V PWM signal or resistor.

SPECIFICATION

MODEL	HLG-150-12	HLG-150-15	HLG-150-20	HLG-150-24	HLG-150-30	HLG-150-36	HLG-150-42	HLG-150-48	HLG-150-54		
OUTPUT	DC VOLTAGE	12V	15V	20V	24V	30V	36V	42V	48V	54V	
	CONSTANT CURRENT REGION Note.4	6 ~ 12V	7.5 ~ 15V	10 ~ 20V	12 ~ 24V	15 ~ 30V	18 ~ 36V	21 ~ 42V	24 ~ 48V	27 ~ 54V	
	RATED CURRENT	12.5A	10A	7.5A	6.3A	5A	4.2A	3.6A	3.2A	2.8A	
	RATED POWER	150W	150W	150W	151.2W	150W	151.2W	151.2W	153.6W	151.2W	
	RIPPLE & NOISE (max.) Note.2	150mVp-p	150mVp-p	150mVp-p	150mVp-p	200mVp-p	200mVp-p	200mVp-p	200mVp-p	200mVp-p	
	VOLTAGE ADJ. RANGE Note.6	10.8 ~ 13.5V	13.5 ~ 17V	17 ~ 22V	22 ~ 27V	27 ~ 33V	33 ~ 40V	38 ~ 46V	43 ~ 53V	49 ~ 58V	
	CURRENT ADJ. RANGE	Can be adjusted by internal potential meter or through output cable									
	VOLTAGE TOLERANCE Note.3	±2.5%	±2.0%	±1.0%	±1.0%	±1.0%	±1.0%	±1.0%	±1.0%	±1.0%	
	LINE REGULATION	±0.5%	±0.5%	±0.5%	±0.5%	±0.5%	±0.5%	±0.5%	±0.5%	±0.5%	
	LOAD REGULATION	±2.0%	±1.5%	±1.0%	±0.5%	±0.5%	±0.5%	±0.5%	±0.5%	±0.5%	
SETUP, RISE TIME Note.8	2500ms, 80ms at full load 230VAC / 115VAC ; B type 2500ms, 200ms at 95% load 230VAC / 115VAC										
HOLD UP TIME (Typ.)	16ms at full load 230VAC / 115VAC										
INPUT	VOLTAGE RANGE Note.5	90 ~ 264VAC 127 ~ 370VDC									
	FREQUENCY RANGE	47 ~ 63Hz									
	POWER FACTOR	PF ≥ 0.95/230VAC				PF ≥ 0.98/115VAC at full load and rated output voltage				PF ≥ 0.9 at 60 ~ 100% load	
	EFFICIENCY (Typ.)	92%	92.5%	93%	93.5%	93.5%	93.5%	94%	94%	94%	
	AC CURRENT	1.7A / 115VAC		0.75A / 230VAC							
	INRUSH CURRENT(Typ.)	COLD START 75A/230VAC									
LEAKAGE CURRENT	<0.75mA / 240VAC										
PROTECTION	OVER CURRENT Note.4	95 ~ 108%									
	SHORT CIRCUIT	Protection type : Constant current limiting, recovers automatically after fault condition is removed									
	OVER VOLTAGE	14 ~ 17V	18 ~ 21V	23 ~ 27V	28 ~ 34V	34 ~ 38V	41 ~ 46V	47 ~ 53V	54 ~ 60V	59 ~ 65V	
	OVER TEMPERATURE	100°C ±10°C (RTH2)									
ENVIRONMENT	WORKING TEMP.	-40 ~ +60°C @ full load ; +70°C @ 60% load (Refer to derating curve)									
	WORKING HUMIDITY	20 ~ 95% RH non-condensing									
	STORAGE TEMP., HUMIDITY	-40 ~ +80°C, 10 ~ 95% RH									
	TEMP. COEFFICIENT	±0.03%/°C (0 ~ 50°C)									
	VIBRATION	10 ~ 500Hz, 5G 12min./1cycle, period for 72min. each along X, Y, Z axes									
SAFETY & EMC	SAFETY STANDARDS Note.7	UL8750, EN61347-1, EN61347-2-13 independent IP65 or IP67 approved ; Design refer to UL60950-1, TUV EN60950-1									
	WITHSTAND VOLTAGE	I/P-O/P:3.75KVAC I/P-FG:1.88KVAC O/P-FG:0.5KVAC									
	ISOLATION RESISTANCE	I/P-O/P, I/P-FG, O/P-FG:100M Ohms / 500VDC / 25°C / 70% RH									
	EMI CONDUCTION & RADIATION	Compliance to EN55015, EN55022 (CISPR22) Class B									
	HARMONIC CURRENT	Compliance to EN61000-3-2 Class C (≥ 60% load) ; EN61000-3-3									
OTHERS	EMS IMMUNITY	Compliance to EN61000-4-2,3,4,5,6,8,11; ENV50204, EN61547, EN55024, heavy industry level (surge 4KV), criteria A									
	MTBF	192.2Khrs min. MIL-HDBK-217F (25°C)									
	DIMENSION	228*68*38.8mm (L*W*H)									
NOTE	PACKING	1.15Kg; 12pcs/14.8Kg/0.76CUFT									
		1. All parameters NOT specially mentioned are measured at 230VAC input, rated load and 25°C of ambient temperature. 2. Ripple & noise are measured at 20MHz of bandwidth by using a 12" twisted pair-wire terminated with a 0.1uf & 47uf parallel capacitor. 3. Tolerance : includes set up tolerance, line regulation and load regulation. 4. Constant current operation region is within 60% ~ 100% rated output voltage. This is the suitable operation region for LED related applications, but please reconfirm special electrical requirements for some specific system design. 5. Derating may be needed under low input voltages. Please check the static characteristics for more details. 6. Type A only. 7. Safety and EMC design refer to EN60598-1, CNS15233, GB7000.1, FCC part18. 8. Length of set up time is measured at cold first start. Turning ON/OFF the power supply may lead to increase of the set up time. 9. The power supply is considered as a component that will be operated in combination with final equipment. Since EMC performance will be affected by the complete installation, the final equipment manufacturers must re-qualify EMC Directive on the complete installation again. 10. Refer to warranty statement.									

Mechanical Specification

Case No.994D Unit:mm

Blank:(HLG-150)

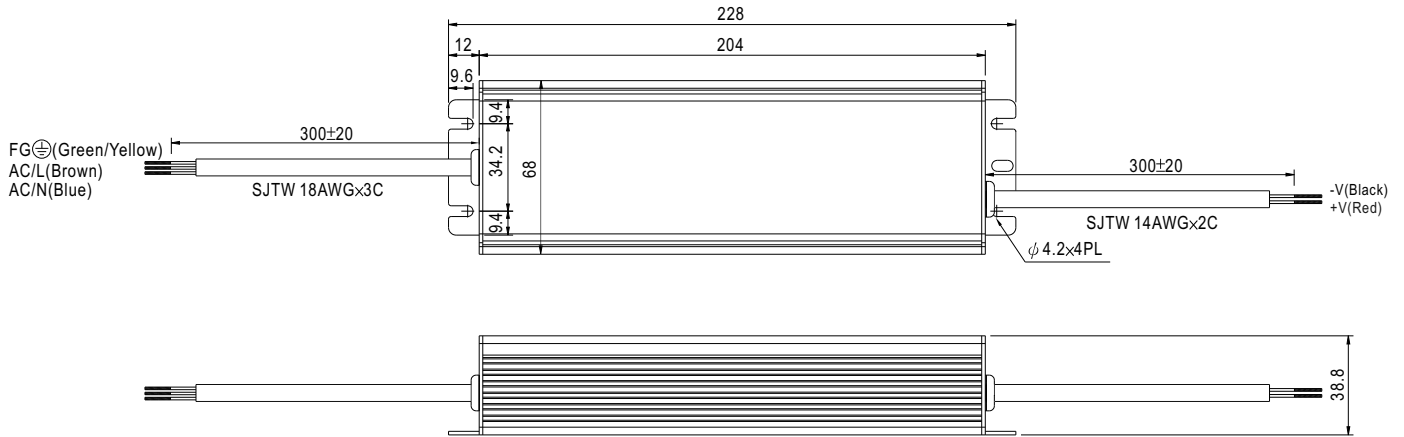

※IP67 rated. Cable for I/O connection.

A Type:(HLG-150_ A)

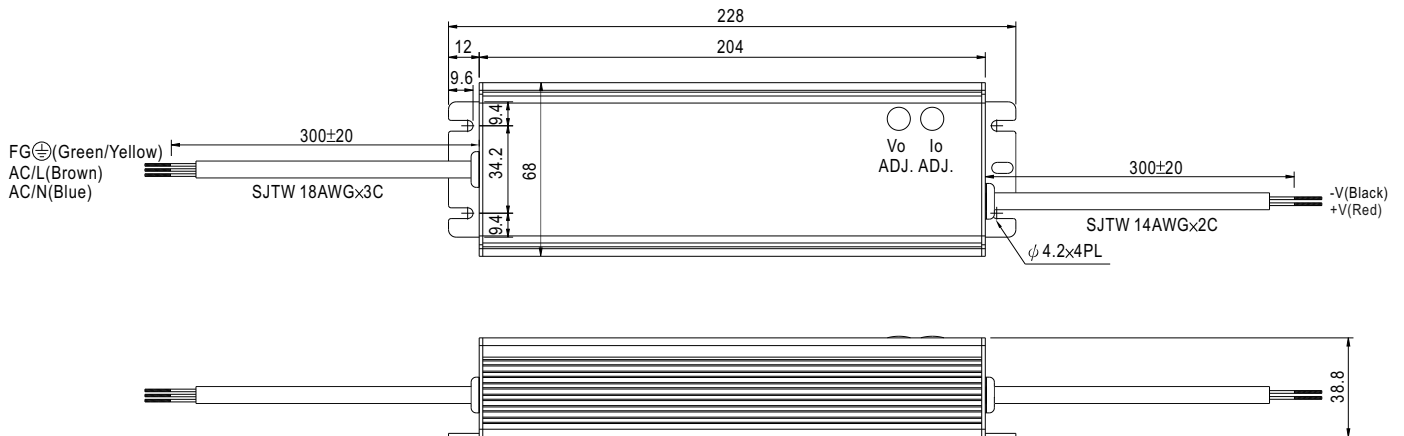

※ IP65 rated. Output voltage and constant current level can be adjusted through internal potential meter.
(Can access by removing the rubber stopper on the case.)

B Type:(HLG-150_ B)

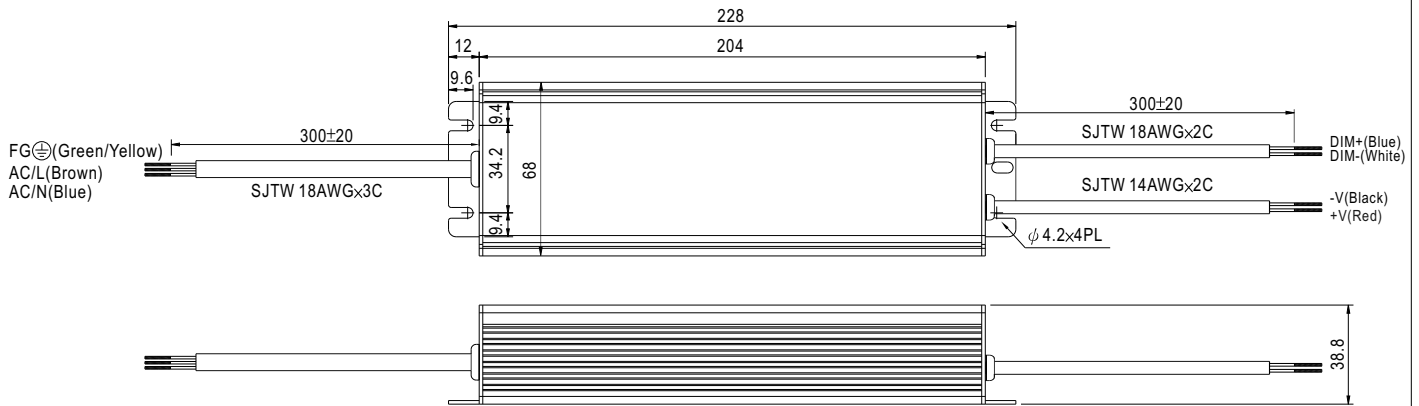

※ IP67 rated. Output constant current level can be adjusted through output cable by connecting a resistor or 1 ~ 10Vdc or 10V PWM signal between DIM+ and DIM-.

※ Please DO NOT connect "DIM-" to "-V".

※ Reference resistance value for output current adjustment (Typical)

Resistance value	10KΩ	20KΩ	30KΩ	40KΩ	50KΩ	60KΩ	70KΩ	80KΩ	90KΩ	100KΩ	OPEN
Percentage of rated current	10%	20%	30%	40%	50%	60%	70%	80%	90%	100%	102%~108%

※ 1 ~ 10V dimming function for output current adjustment (Typical)

Dimming value	1V	2V	3V	4V	5V	6V	7V	8V	9V	10V	OPEN
Percentage of rated current	10%	20%	30%	40%	50%	60%	70%	80%	90%	100%	102%~108%

※ 10V PWM signal for output current adjustment (Typical): Frequency range : 100HZ ~ 3KHz

Duty value	10%	20%	30%	40%	50%	60%	70%	80%	90%	100%	OPEN
Percentage of rated current	10%	20%	30%	40%	50%	60%	70%	80%	90%	100%	102%~108%

Block Diagram

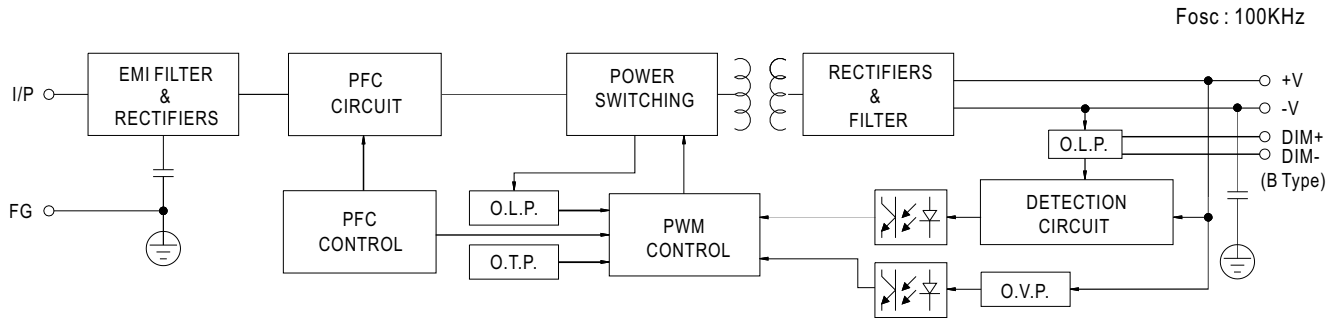

Derating Curve

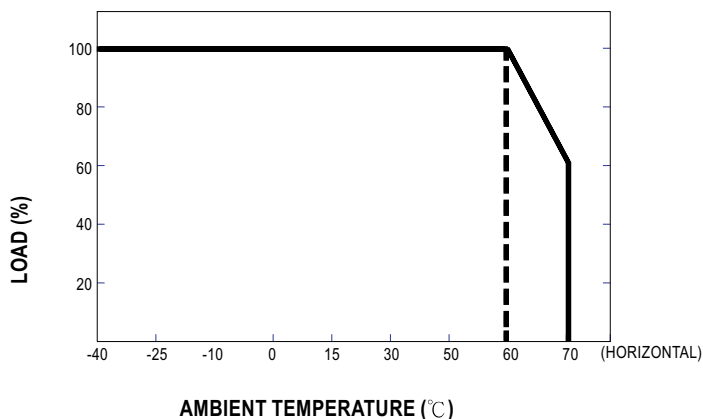

Static Characteristics

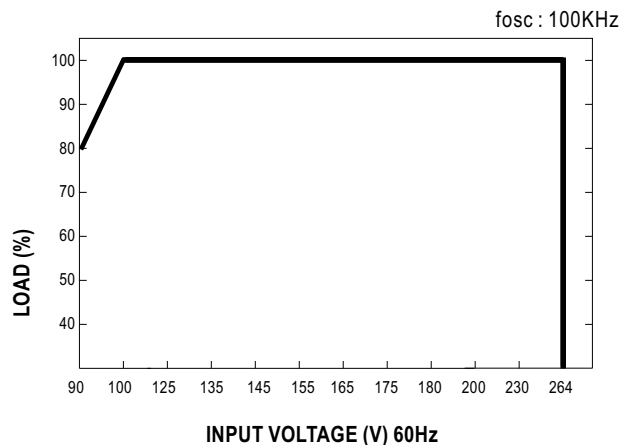

Power Factor Characteristic

Power factor will be higher than 0.9 when output loading is 60% or higher.

Constant Current Mode

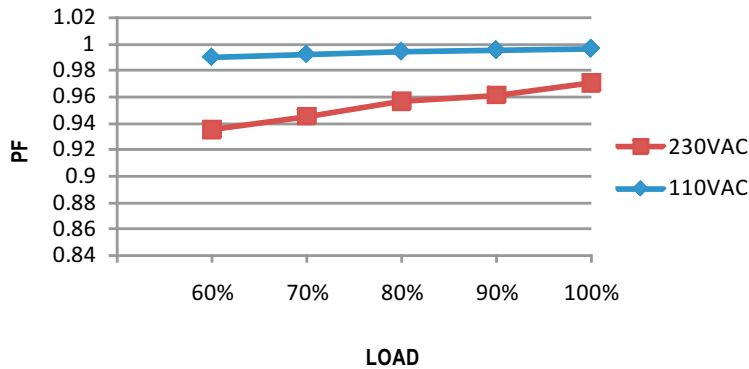

EFFICIENCY vs LOAD (48V Model)

HLG-150 series possess superior working efficiency that up to 94% can be reached in field applications.

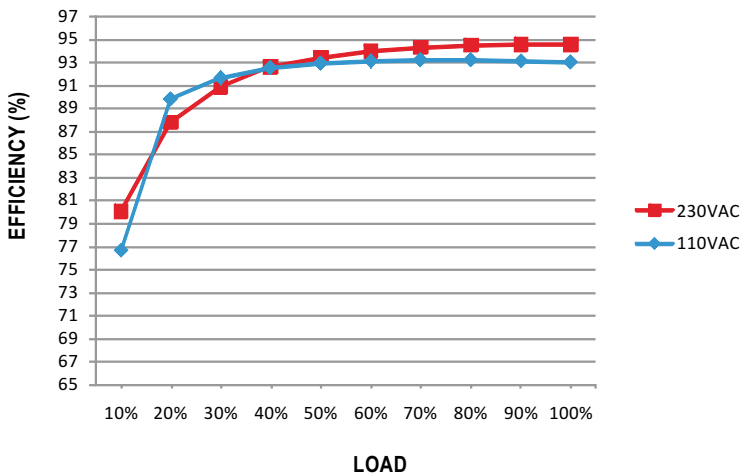

DRIVING METHODS OF LED MODULE

There are two major kinds of LED drive method "direct drive" and "with LED driver".

A typical LED power supply may either work in "constant voltage mode (CV) or constant current mode (CC)" to drive the LEDs.

Mean Well's LED power supply with CV+ CC characteristic can be operated at both CV mode (with LED driver, at area (A) and CC mode (direct drive, at area (B)).

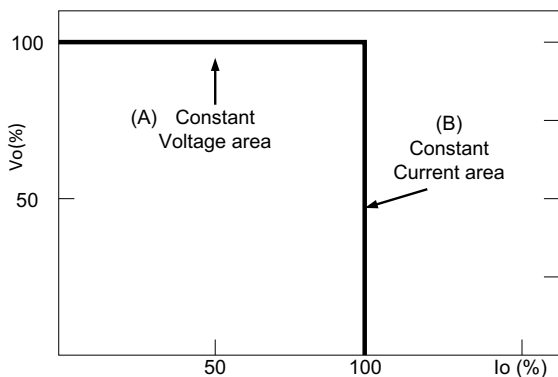

Typical LED power supply I-V curve

◎ **Direct driving :**

Under direct driving, the power supply will work in "constant current mode (CC)" and output voltage of the power supply will be clamped by sum of forward voltage (V_f) of the LED strip.

The total forward voltage of series connecting LEDs is suggested for 60%~95% of power supply rated output voltage due to concern of the best PF value and efficiency.

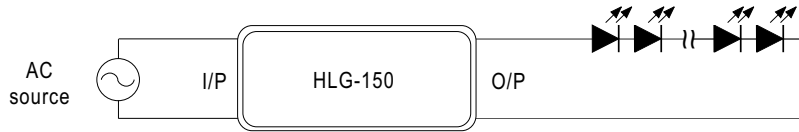

◎ **With LED driver :**

Using additional driver, the power supply will work in "constant voltage mode (CV)" and output voltage of the power supply will be kept in rated value. In this drive mode, several design issues need to be considered:

1. Output voltage of PSU must be higher than total forward voltage of series connecting LEDs by 3V minimum.
2. Input capacitor (C_{in}) of LED driver circuit should use 47 μ F ~ 100 μ F (typ.) of rating depends on the operating frequency of the LED driver.
The higher the operating frequency is used, the smaller value of C_{in} should be chosen, and vice versa.
3. Do not use B type with LED driver.

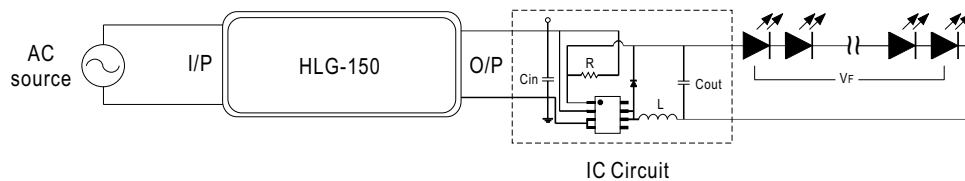

■ **DIMMING OPERATION(for B-type only)**

Using the built-in dimming function on B-type model can't turn the lighting fixture totally dark. Please refer to the connection method below to achieve 0% brightness of the lighting fixture connecting to the LED power supply unit.

◎ **Dimming connection diagram for turning the lighting fixture ON/OFF :**

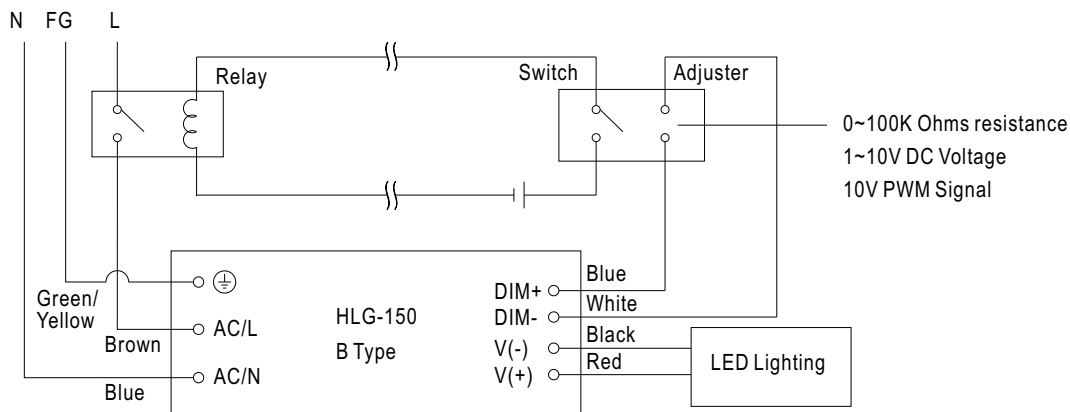

Using a switch and relay can turn ON/OFF the lighting fixture.

1. Output constant current level can be adjusted through output cable by connecting a resistor or 1~10Vdc or 10V PWM signal between DIM+ and DIM-.
2. The LED lighting fixture can be turned ON/OFF by the switch.

EMI DEBUG SUGGESTION

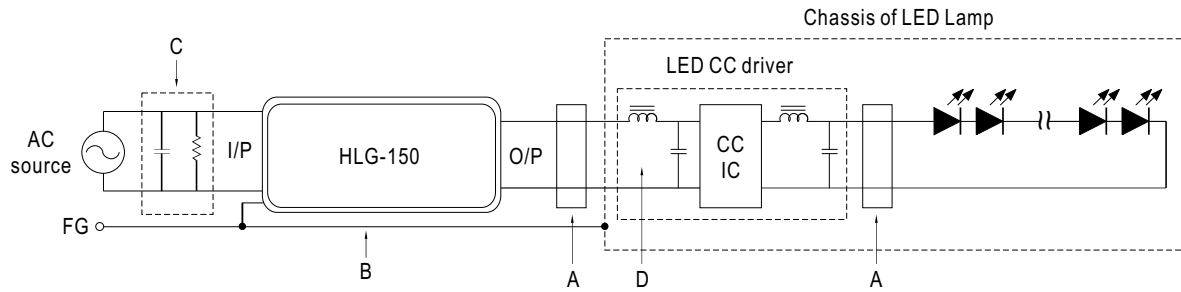

- A. Add a common mode ferrite choke on output wires to reduce the common emission between 10M ~ 300MHz per lighting EMI regulation.
- B. Chassis of LED lamp and chassis of HLG-150 or the FG wire should be connected to the safety ground to reduce the EMI noise, including the conduction and radiation emission.
- C. The additional X-Cap and discharge resistor can reduce the low frequency conduction noise between 9K ~ 1MHz per lighting EMI regulation.
- D. L-C filter should be added at the DC input of LED constant current driver to avoid the differential emission and high frequency noise generated by the CC driver.

WATERPROOF CONNECTION

◎ Waterproof connector

Waterproof connector can be assembled on the output cable of HLG-150 to operate in dry/wet/damp or outdoor environment.

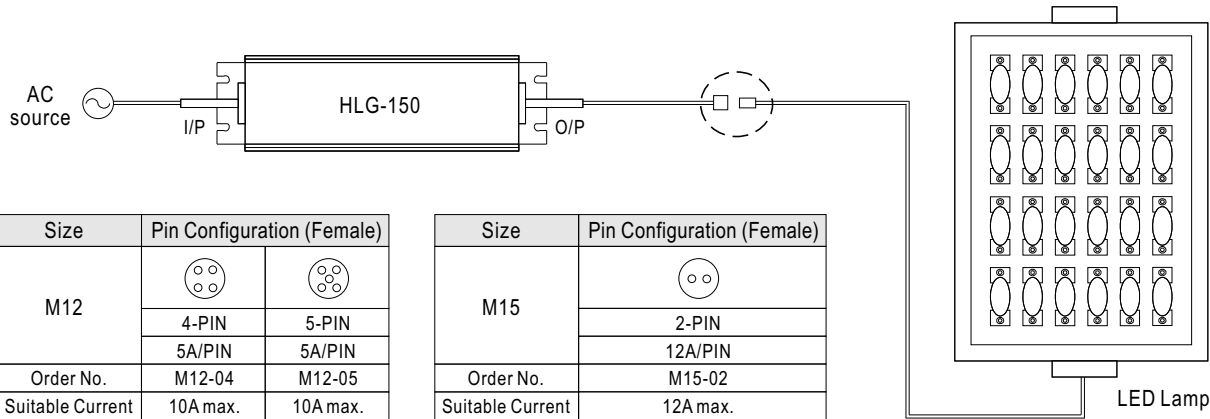

◎ Cable Joiner

