

PKB 4000B series Intermediate Bus Converters
 Input 36-75 V, Output up to 40 A / 252 W

EN/LZT 146 384 R3C January 2010

© Ericsson AB

Key Features

- Industry standard low profile Eighth-brick
 58.4 x 22.7 x 10.1 mm (2.3 x 0.894 x 0.397 in.)
- High efficiency, typ. 95 % at 12 V half load
- 1500 Vdc input to output isolation
- Meets isolation requirements equivalent to basic insulation according to IEC/EN/UL 60950
- More than 1.3 million hours MTBF

General Characteristics

- N+1 parallelable
- Input under voltage protection
- Over temperature protection
- Output over voltage protection
- Output short-circuit protection
- Remote control
- Optional baseplate
- Highly automated manufacturing ensures quality
- ISO 9001/14001 certified supplier

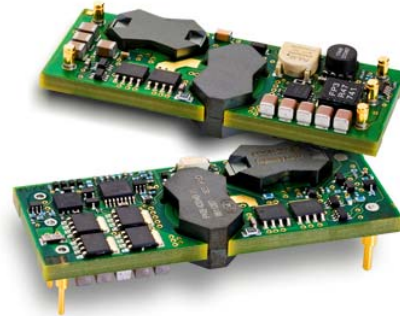

Safety Approvals



E210157

Design for Environment



Meets requirements in high-temperature lead-free soldering processes.

Contents

Ordering Information	2
General Information	2
Safety Specification	3
Absolute Maximum Ratings	4
Electrical Specification		
5.0 V, 40 A / 200 W	PKB 4201B PI	5
12.0 V, 20 A / 240 W	PKB 4204B PI	8
13.0 V, 20 A / 252 W	PKB 4207LB PI	11
EMC Specification	14
Operating Information	15
Thermal considerations	16
Connections	17
Mechanical Information	18
Soldering Information	21
Delivery Information	22
Product Qualification Specification	23

PKB 4000B series Intermediate Bus Converters Input 36-75 V, Output up to 40 A / 252 W	EN/LZT 146 384 R3C January 2010
	© Ericsson AB

Ordering Information

Product program	Output
PKB4201B PI	5 V, 40 A / 200 W
PKB4204B PI	12 V, 20 A / 240 W
PKB4207LB PI	13 V, 20 A / 252 W

Product number and Packaging

PKB4204B PI n ₁ n ₂ n ₃ n ₄ n ₅ n ₆						
Options	n ₁	n ₂	n ₃	n ₄	n ₅	n ₆
Mounting	o					
Remote control logic		o				
Baseplate			o			
Increased stand-off				o		
Pin length					o	
Delivery package information						o

Options	Description	
n ₁	PI	Through hole
	SI	Surface mount
n ₂	P	Negative *
		Positive
n ₃	HS	Open frame *
		Baseplate
n ₄	M	Increased stand-off
n ₅		5.30 mm *
	LA	3.69 mm
	LB	4.57 mm
n ₆	/B	Tray

Example: a standard through hole, positive logic, baseplate with increased stand-off short pin product would be PKB4204BPIPHSMLA.

* Standard variant (i.e. no option selected).

General Information

Reliability

The Mean Time Between Failure (MTBF) is calculated at full output power and an operating ambient temperature (T_A) of +40°C, which is a typical condition in Information and Communication Technology (ICT) equipment. Different methods could be used to calculate the predicted MTBF and failure rate which may give different results. Ericsson Power Modules currently uses Telcordia SR332.

Predicted MTBF for the series is:

- 1.5 million hours according to Telcordia SR332, issue 1, Black box technique.

Telcordia SR332 is a commonly used standard method intended for reliability calculations in ICT equipment. The parts count procedure used in this method was originally modelled on the methods from MIL-HDBK-217F, Reliability

Predictions of Electronic Equipment. It assumes that no reliability data is available on the actual units and devices for which the predictions are to be made, i.e. all predictions are based on generic reliability parameters.

Compatibility with RoHS requirements

The products are compatible with the relevant clauses and requirements of the RoHS directive 2002/95/EC and have a maximum concentration value of 0.1% by weight in homogeneous materials for lead, mercury, hexavalent chromium, PBB and PBDE and of 0.01% by weight in homogeneous materials for cadmium.

Exemptions in the RoHS directive utilized in Ericsson Power Modules products include:

- Lead in high melting temperature type solder (used to solder the die in semiconductor packages)
- Lead in glass of electronics components and in electronic ceramic parts (e.g. fill material in chip resistors)
- Lead as an alloying element in copper alloy containing up to 4% lead by weight (used in connection pins made of Brass)

Quality Statement

The products are designed and manufactured in an industrial environment where quality systems and methods like ISO 9000, 6σ (sigma), and SPC are intensively in use to boost the continuous improvements strategy. Infant mortality or early failures in the products are screened out and they are subjected to an ATE-based final test. Conservative design rules, design reviews and product qualifications, plus the high competence of an engaged work force, contribute to the high quality of our products.

Warranty

Warranty period and conditions are defined in Ericsson Power Modules General Terms and Conditions of Sale.

Limitation of Liability

Ericsson Power Modules does not make any other warranties, expressed or implied including any warranty of merchantability or fitness for a particular purpose (including, but not limited to, use in life support applications, where malfunctions of product can cause injury to a person's health or life).

© Ericsson AB 2009

The information and specifications in this technical specification is believed to be correct at the time of publication. However, no liability is accepted for inaccuracies, printing errors or for any consequences thereof. Ericsson AB reserves the right to change the contents of this technical specification at any time without prior notice.

PKB 4000B series Intermediate Bus Converters
Input 36-75 V, Output up to 40 A / 252 W

EN/LZT 146 384 R3C January 2010

© Ericsson AB

Safety Specification**General information**

Ericsson Power Modules DC/DC converters and DC/DC regulators are designed in accordance with safety standards IEC/EN/UL60950, *Safety of Information Technology Equipment*.

IEC/EN/UL60950 contains requirements to prevent injury or damage due to the following hazards:

- Electrical shock
- Energy hazards
- Fire
- Mechanical and heat hazards
- Radiation hazards
- Chemical hazards

On-board DC-DC converters and DC/DC regulators are defined as component power supplies. As components they cannot fully comply with the provisions of any Safety requirements without "Conditions of Acceptability". Clearance between conductors and between conductive parts of the component power supply and conductors on the board in the final product must meet the applicable Safety requirements. Certain conditions of acceptability apply for component power supplies with limited stand-off (see Mechanical Information for further information). It is the responsibility of the installer to ensure that the final product housing these components complies with the requirements of all applicable Safety standards and Directives for the final product.

Component power supplies for general use should comply with the requirements in IEC60950, EN60950 and UL60950 "*Safety of information technology equipment*". There are other more product related standards, e.g. IEEE802.3af "Ethernet LAN/MAN Data terminal equipment power", and ETS300132-2 "Power supply interface at the input to telecommunications equipment; part 2: DC", but all of these standards are based on IEC/EN/UL60950 with regards to safety.

Ericsson Power Modules DC/DC converters and DC/DC regulators are UL60950 recognized and certified in accordance with EN60950.

The flammability rating for all construction parts of the products meets requirements for V-0 class material according to IEC 60695-11-10.

The products should be installed in the end-use equipment, in accordance with the requirements of the ultimate application. Normally the output of the DC/DC converter is considered as SELV (Safety Extra Low Voltage) and the input source must be isolated by minimum Double or Reinforced Insulation from the primary circuit (AC mains) in accordance with IEC/EN/UL60950.

Isolated DC/DC converters

It is recommended that a slow blow fuse with a rating twice the maximum input current per selected product be used at the input of each DC/DC converter. If an input filter is used in the circuit the fuse should be placed in front of the input filter.

In the rare event of a component problem in the input filter or in the DC/DC converter that imposes a short circuit on the input source, this fuse will provide the following functions:

- Isolate the faulty DC/DC converter from the input power source so as not to affect the operation of other parts of the system.
- Protect the distribution wiring from excessive current and power loss thus preventing hazardous overheating.

The galvanic isolation is verified in an electric strength test. The test voltage (V_{iso}) between input and output is 1500 Vdc or 2250 Vdc for 60 seconds (refer to product specification). Leakage current is less than 1 μ A at nominal input voltage.

24 V DC systems

The input voltage to the DC/DC converter is SELV (Safety Extra Low Voltage) and the output remains SELV under normal and abnormal operating conditions.

48 and 60 V DC systems

If the input voltage to the DC/DC converter is 75 Vdc or less, then the output remains SELV (Safety Extra Low Voltage) under normal and abnormal operating conditions.

Single fault testing in the input power supply circuit should be performed with the DC/DC converter connected to demonstrate that the input voltage does not exceed 75 Vdc.

If the input power source circuit is a DC power system, the source may be treated as a TNV2 circuit and testing has demonstrated compliance with SELV limits and isolation requirements equivalent to Basic Insulation in accordance with IEC/EN/UL60950.

Non-isolated DC/DC regulators

The input voltage to the DC/DC regulator is SELV (Safety Extra Low Voltage) and the output remains SELV under normal and abnormal operating conditions.

PKB 4000B series Intermediate Bus Converters
 Input 36-75 V, Output up to 40 A / 252 W

EN/LZT 146 384 R3C January 2010
 © Ericsson AB

Absolute Maximum Ratings

Characteristics		min	typ	max	Unit
T_{ref}	Operating Temperature (see Thermal Consideration section)	-40		+125	°C
T_S	Storage temperature	-40		+125	°C
V_I	Input voltage	-0.5		+80	V
V_{iso}	Isolation voltage (input to output test voltage)			1500	Vdc
V_{tr}	Input voltage transient (t_p 100 ms)			100	V
V_{RC}	Remote Control pin voltage (see Operating Information section)	Positive logic option		15	V
		Negative logic option	-0.5	15	V

Stress in excess of Absolute Maximum Ratings may cause permanent damage. Absolute Maximum Ratings, sometimes referred to as no destruction limits, are normally tested with one parameter at a time exceeding the limits of Output data or Electrical Characteristics. If exposed to stress above these limits, function and performance may degrade in an unspecified manner.

Fundamental Circuit Diagram

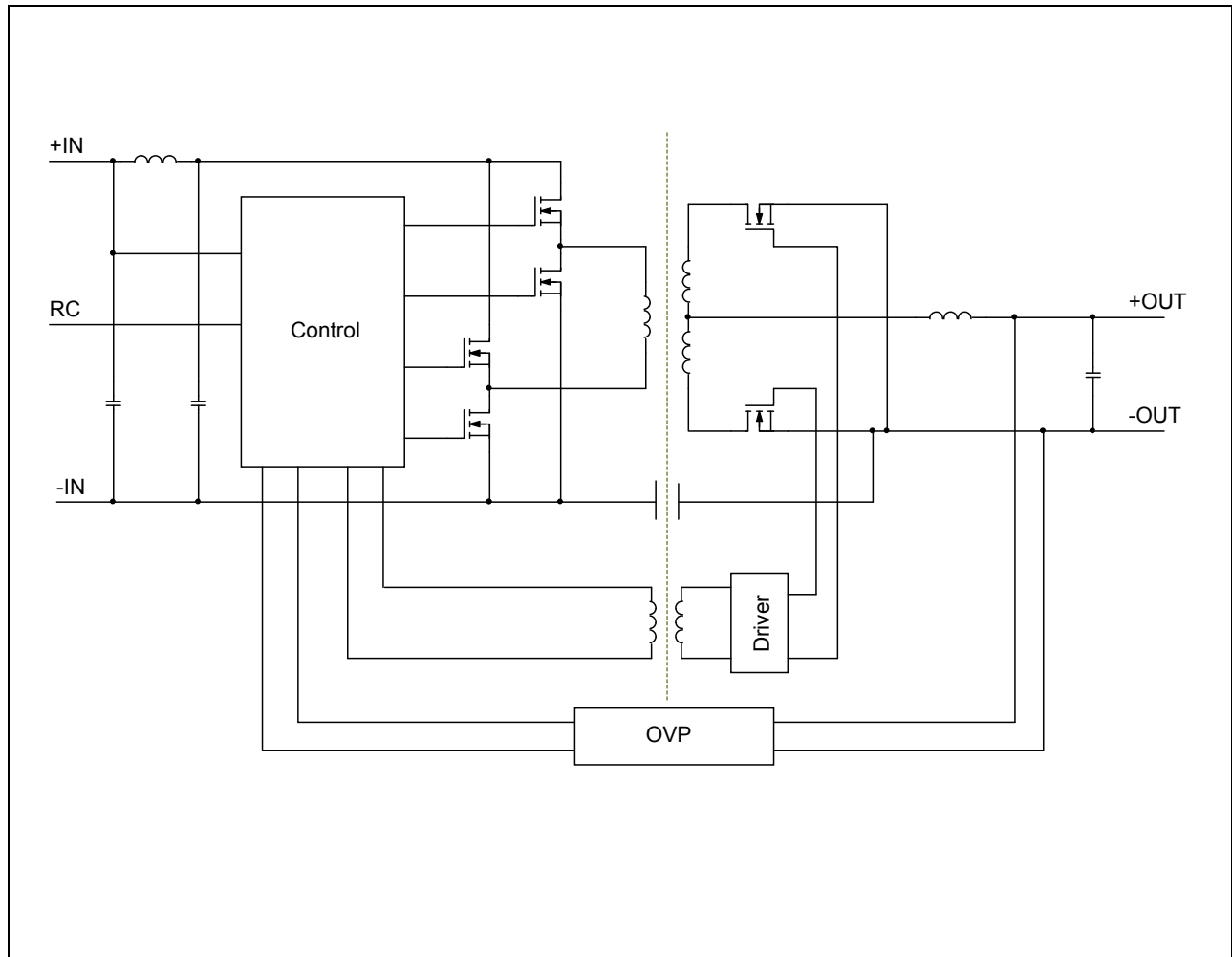

PKB 4000B series Intermediate Bus Converters Input 36-75 V, Output up to 40 A / 252 W	EN/LZT 146 384 R3C January 2010 © Ericsson AB
---	--

5 V, 40 A / 200 W Electrical Specification
PKB 4201B PI

$T_{ref} = -30$ to $+90$ °C, $V_I = 36$ to 75 V, unless otherwise specified under Conditions.
 Typical values given at: $T_{ref} = +25$ °C, $V_I = 53$ V, max I_O , unless otherwise specified under Conditions.

Characteristics	Conditions	min	Typ	max	Unit
V_I	Input voltage range	36		75	V
V_{Ioff}	Turn-off input voltage	32	33	35	V
V_{Ion}	Turn-on input voltage	33	35	36	V
C_I	Internal input capacitance		11		µF
P_O	Output power	$V_I = 75$ V	0	194	W
		$V_I = 53$ V	0	194	
		$V_I = 36$ V	0	194	
η	Efficiency	50 % of max I_O , $V_I = 53$ V	94.5		%
		max I_O , $V_I = 53$ V	94.0		
P_d	Power Dissipation	max I_O	12	18	W
P_{II}	Input idling power	$I_O = 0$ A, $V_I = 53$ V	4		W
P_{RC}	Input standby power	$V_I = 53$ V (turned off with RC)	0.12		W
f_s	Switching frequency	0-100 % of max I_O	180		kHz

V_{Oi}	Output voltage initial setting and accuracy	$T_{ref} = +25$ °C, $V_I = 53$ V, $I_O = 20$ A	4.9	5.0	5.1	V
V_O	Output voltage tolerance band	0-100 % of max I_O , $V_I = 36$ V to 75 V, see Note 3	4.5		5.5	V
	Idling voltage	$I_O = 0$ A	4.75		5.5	V
	Line regulation	$V_I = 36$ V to 75 V		0.04		V
	Load regulation	$V_I = 53$ V, 0-100 % of max I_O	0.1	0.25	0.4	V
V_{tr}	Load transient voltage deviation	$V_I = 53$ V, Load step 50-75-50 % of max I_O , di/dt = 1 A/µs, see Note 1		0.27		V
t_{tr}	Load transient recovery time			0.06		ms
t_r	Ramp-up time (from 10-90 % of V_{Oi})	0-100 % of max I_O , see Note 1 & 2	1	4	7	ms
t_s	Start-up time (from V_I connection to 90 % of V_{Oi})		5	10	14	ms
t_f	V_I shut-down fall time (from V_{Ioff} to 10 % of V_{Oi})	max I_O , see Note 1		0.5		ms
		$I_O = 0$ A, see Note 1		16		s
t_{RC}	RC start-up time	max I_O , see Note 1 & 2		7		ms
	RC shut-down fall time (from RC off to 10 % of V_{Oi})	max I_O , see Note 1		0.3		ms
		$I_O = 0$ A, see Note 1		16		s
I_O	Output current		0		40	A
I_{lim}	Current limit threshold	$T_{ref} < \max T_{ref}$	42	50	65	A
I_{sc}	Short circuit current	$T_{ref} = 25$ °C		53		A
C_{out}	Recommended Capacitive Load	$T_{ref} = 25$ °C, see Note 4	1000			µF
V_{Oac}	Output ripple & noise	See ripple & noise section, max I_O		110	220	mVp-p
OVP	Input over voltage protection			79		V
	Output over voltage protection			7.3		

Note 1: A 1 mF external output capacitance was used (ESR approx. 20 mohm).

Note 2: At ramp up with low load will the output voltage have a negative slope during a short time.

Note 3: Negative temperature coefficient: -3 mV/°C.

Note 4: Low ESR type.

PKB 4000B series Intermediate Bus Converters Input 36-75 V, Output up to 40 A / 252 W	EN/LZT 146 384 R3C January 2010 © Ericsson AB
---	--

5 V, 40 A / 200 W Typical Characteristics

PKB 4201B PI

Efficiency

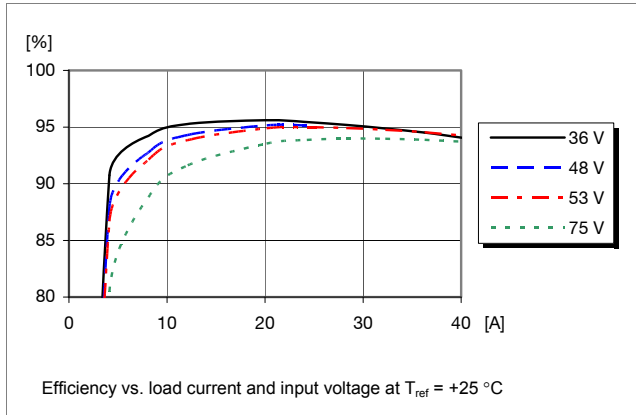

Power Dissipation

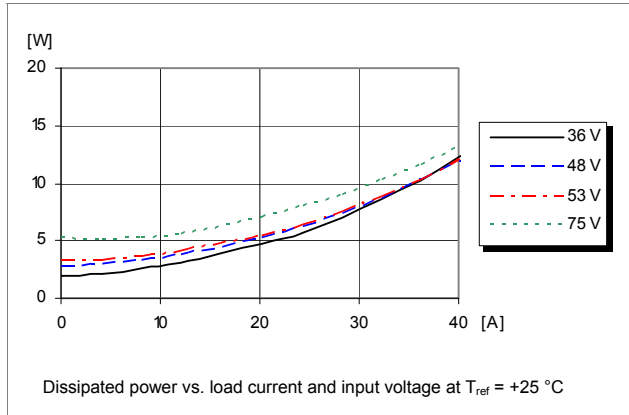

Output Current Derating, open frame

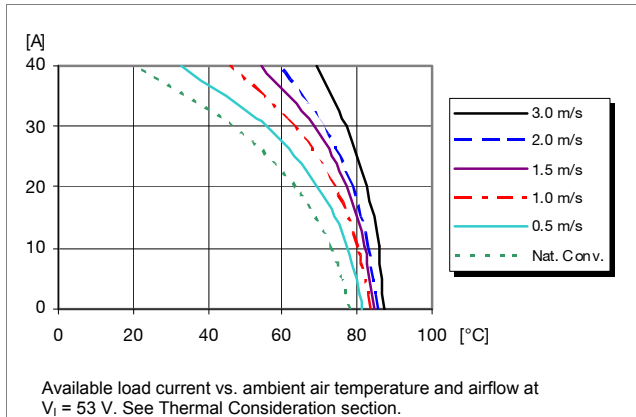

Output Current Derating, base plate option

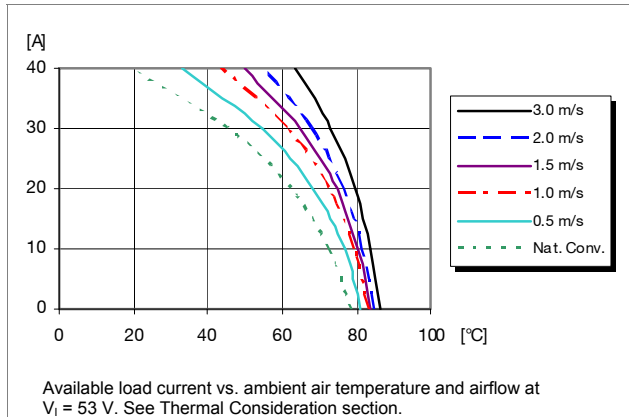

Output Characteristics

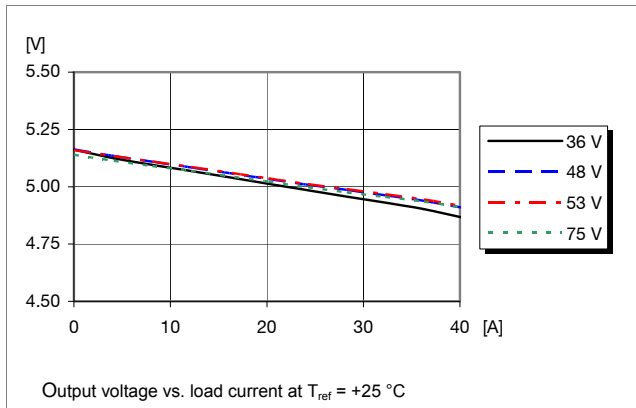

Current Limit Characteristics

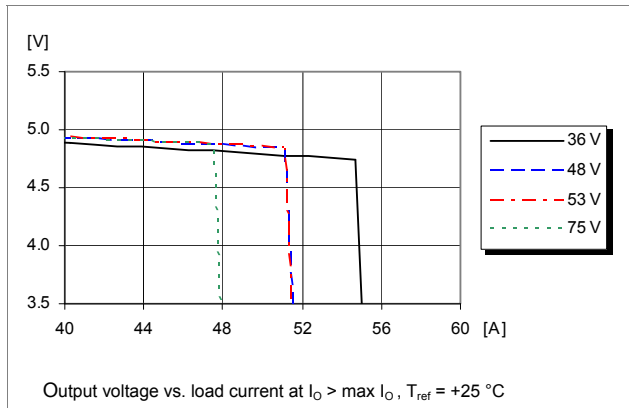

PKB 4000B series Intermediate Bus Converters
 Input 36-75 V, Output up to 40 A / 252 W

EN/LZT 146 384 R3C January 2010
 © Ericsson AB

5 V, 40 A / 200 W Typical Characteristics

PKB 4201B PI

Start-up

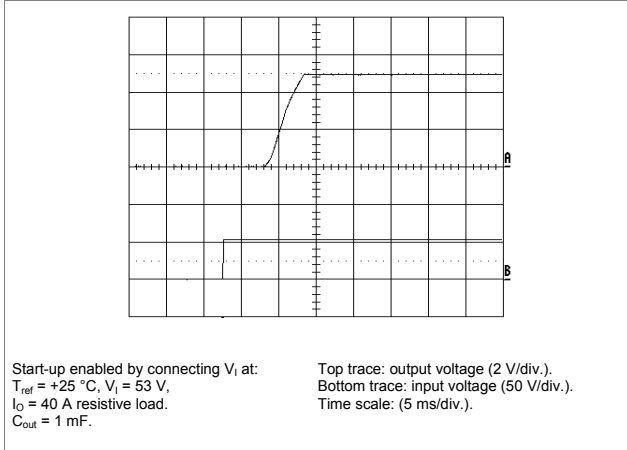

Shut-down

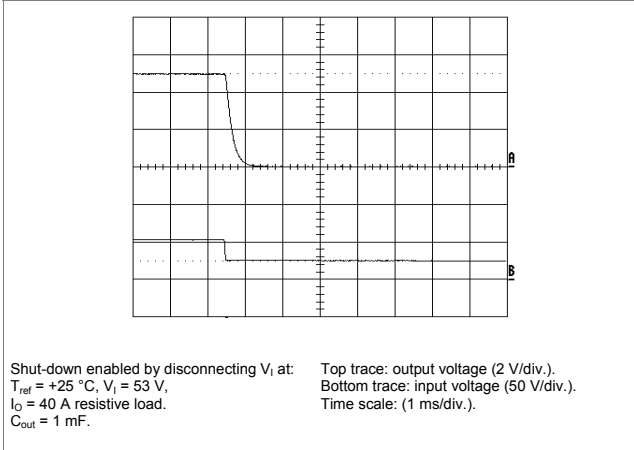

Output Ripple & Noise

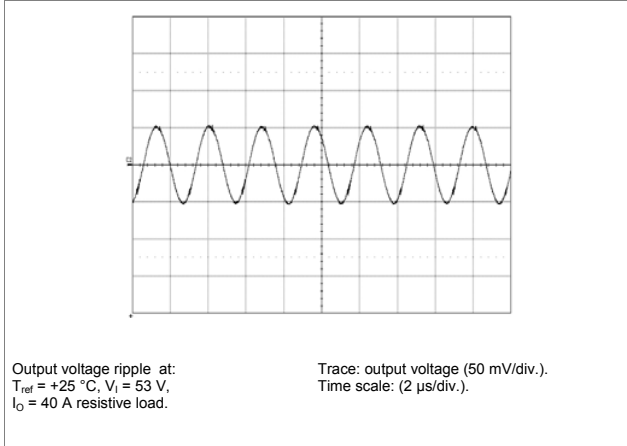

Output Load Transient Response

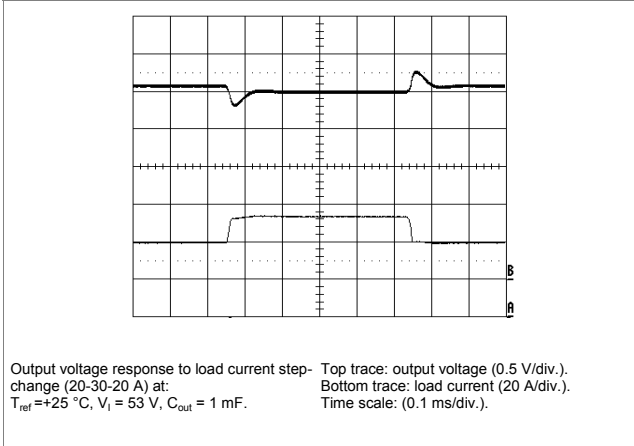

PKB 4000B series Intermediate Bus Converters Input 36-75 V, Output up to 40 A / 252 W	EN/LZT 146 384 R3C January 2010
	© Ericsson AB

12 V, 20 A / 240 W Electrical Specification
PKB 4204B PI

Tref = -30 to +90 °C, VI = 36 to 75 V, unless otherwise specified under Conditions.

Typical values given at: Tref = +25 °C, VI = 53 V, max IO, unless otherwise specified under Conditions.

Characteristics		Conditions	min	Typ	max	Unit
VI	Input voltage range		36		75	V
Vloff	Turn-off input voltage	Decreasing input voltage	32	33	34	V
Vlon	Turn-on input voltage	Increasing input voltage	34	35	36	V
CI	Internal input capacitance			11		µF
PO	Output power	VI = 75 V	0		234	W
		VI = 53 V	0		234	
		VI = 36 V	0		220	
η	Efficiency	50 % of max IO, VI = 53 V		95.5		%
		max IO, VI = 53 V		95.0		
Pd	Power Dissipation	max IO		12.3	17	W
Pli	Input idling power	IO = 0 A, VI = 53 V		3.5		W
PRC	Input standby power	VI = 53 V (turned off with RC)		0.1		W
fs	Switching frequency	0-100 % of max IO		180		kHz

VOi	Output voltage initial setting and accuracy	Tref = +25 °C, VI = 53 V, IO = 10 A	11.82	12.00	12.15	V
VO	Output voltage tolerance band	0-100 % of max IO, VI = 38 V to 75 V, see Note 1	10.8		12.5	V
	Idling voltage	IO = 0 A	11.6		12.5	V
	Line regulation	VI = 38 V to 75 V, see Note 2		0.1		V
	Load regulation	VI = 53 V, 0-100 % of max IO	0.5	0.6	0.9	V
Vtr	Load transient voltage deviation	VI = 53 V, Load step 50-75-50 % of max IO, di/dt = 1 A/µs, see Note 3		0.4		V
ttr	Load transient recovery time			0.25		ms
tr	Ramp-up time (from 10-90 % of VOi)		3	5.6	9	ms
ts	Start-up time (from VI connection to 90 % of VOi)	0-100 % of max IO	9	12	18	ms
tr	VI shut-down fall time (from VI off to 10 % of VO)	max IO		0.06		ms
		IO = 0 A		0.24		s
tRC	RC start-up time	max IO		9		ms
	RC shut-down fall time (from RC off to 10 % of VO)	max IO		0.08		ms
		IO = 0 A		0.23		s
IO	Output current		0		20	A
Ilim	Current limit threshold	Tref < max Tref	23	26	30	A
Cout	Recommended Capacitive Load	Tref = 25°C	0			µF
Isc	Short circuit current	Tref = 25 °C		27		A
VOac	Output ripple & noise	See ripple & noise section, max IO		70	130	mVp-p
OVP	Input over voltage protection			79		V
	Output over voltage protection			13.5		

Note 1: At VI = 36 V to 38 V is the lower limit 10.5 V.

Note 2: At VI = 36 V to 75 V is the typical value 0.6 V.

Note 3: A 220 µF external output capacitance was with low ESR was used.

PKB 4000B series Intermediate Bus Converters Input 36-75 V, Output up to 40 A / 252 W	EN/LZT 146 384 R3C January 2010 © Ericsson AB
---	--

12 V, 20 A / 240 W Typical Characteristics

PKB 4204B PI

Efficiency

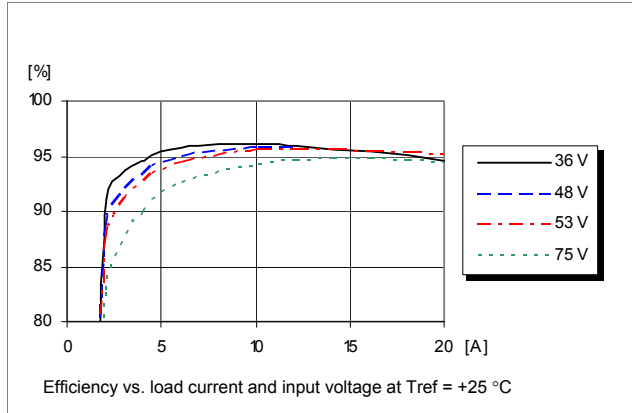

Power Dissipation

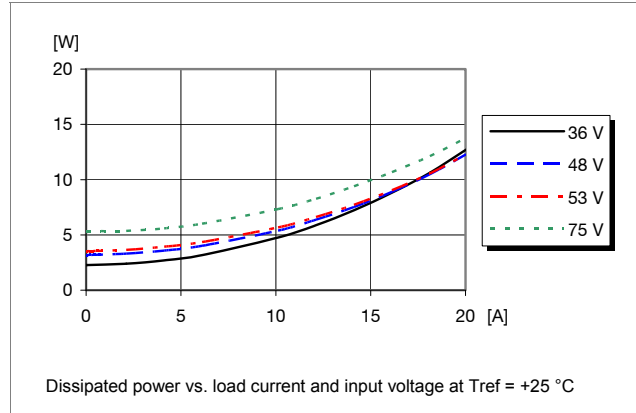

Output Current Derating, open frame

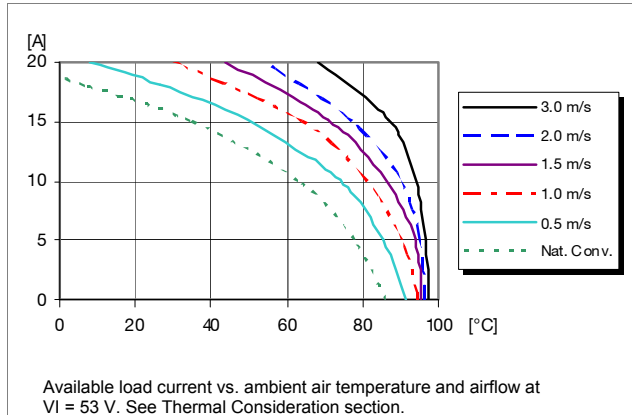

Output Current Derating, base plate option

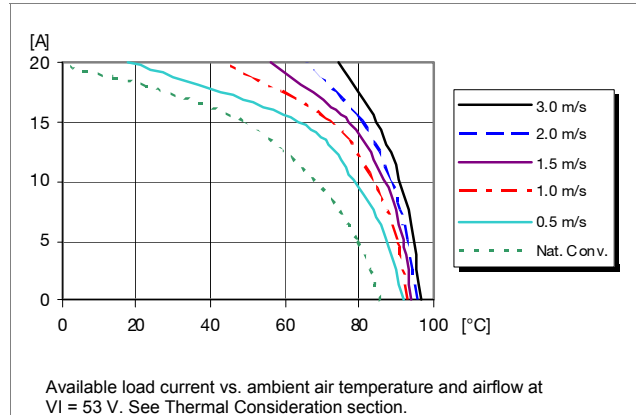

Output Characteristics

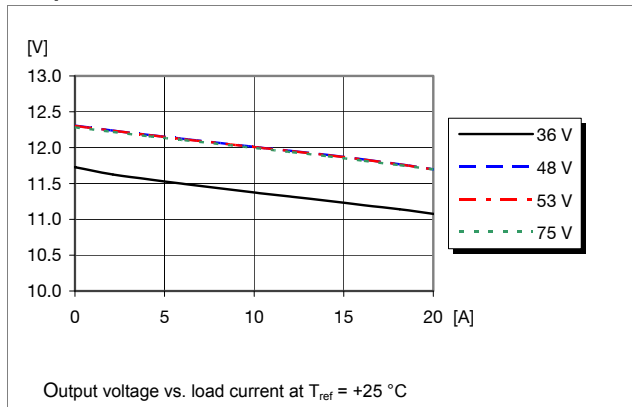

Current Limit Characteristics

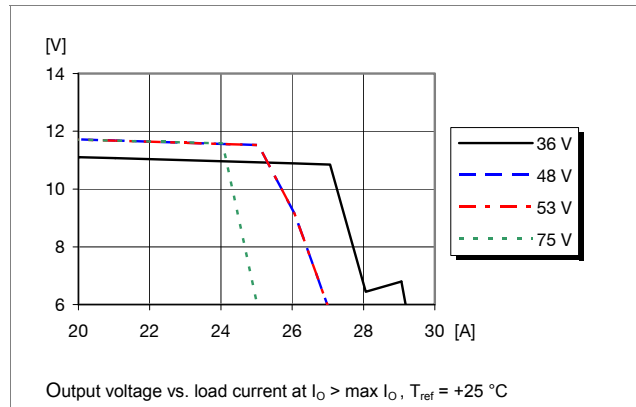

PKB 4000B series Intermediate Bus Converters
 Input 36-75 V, Output up to 40 A / 252 W

EN/LZT 146 384 R3C January 2010
 © Ericsson AB

12 V, 20 A / 240 W Typical Characteristics

PKB 4204B PI

Start-up

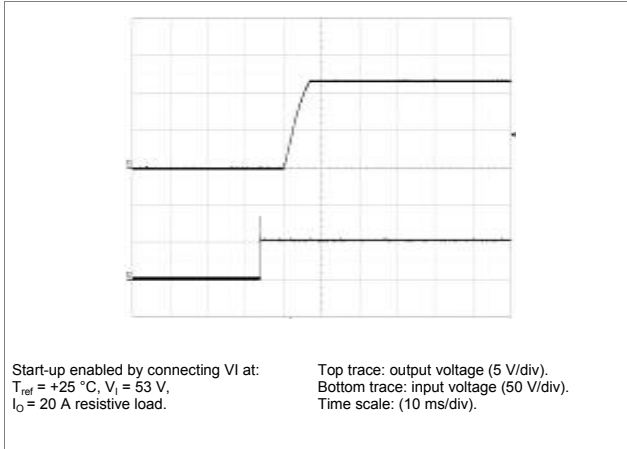

Shut-down

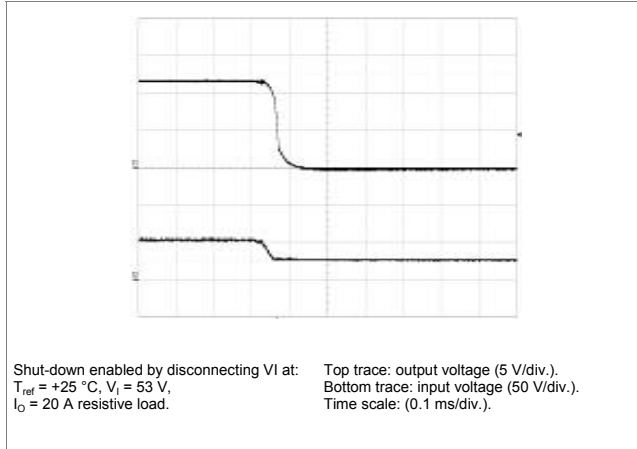

Output Ripple & Noise

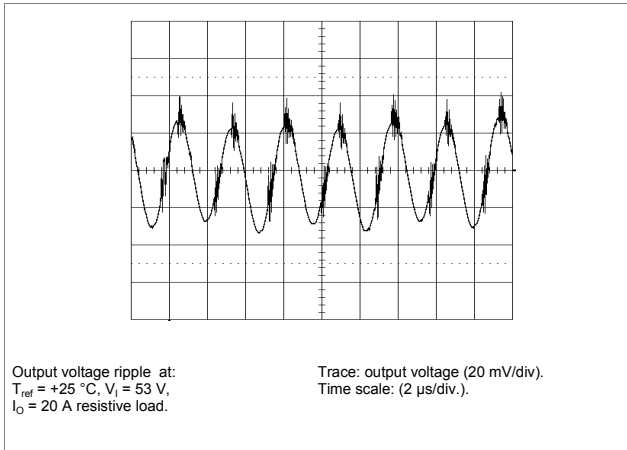

Output Load Transient Response

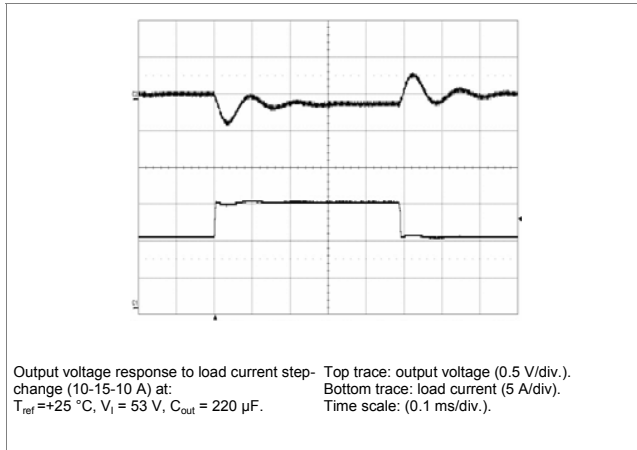

PKB 4000B series Intermediate Bus Converters
 Input 36-75 V, Output up to 40 A / 252 W

EN/LZT 146 384 R3C January 2010

© Ericsson AB

13 V, 20 A / 252 W Electrical Specification
PKB 4207LB PI
 $T_{ref} = -30$ to $+90$ °C, $V_I = 36$ to 75 V, unless otherwise specified under Conditions.

 Typical values given at: $T_{ref} = +25$ °C, $V_I = 53$ V, $I_O = 10$ A, unless otherwise specified under Conditions.

Characteristics	Conditions	min	Typ	max	Unit
V_I	Input voltage range	36		75	V
V_{Ioff}	Turn-off input voltage	32	33	35	V
V_{Ion}	Turn-on input voltage	33	35	36	V
C_I	Internal input capacitance		11		μ F
P_O	Output power	$V_I = 75$ V	0	252	W
		$V_I = 53$ V	0	252	
		$V_I = 36$ V	0	252	
η	Efficiency	50 % of max I_O , $V_I = 53$ V	95		%
		max I_O , $V_I = 53$ V	94		
P_d	Power Dissipation	max I_O	16	25	W
P_{Ii}	Input idling power	$I_O = 0$ A, $V_I = 53$ V	4		W
P_{RC}	Input standby power	$V_I = 53$ V (turned off with RC)	0.1		W
f_s	Switching frequency	0-100 % of max I_O	220		kHz

V_{Oi}	Output voltage initial setting and accuracy	$T_{ref} = +25$ °C, $V_I = 53$ V, $I_O = 10$ A	12.8	13.00	13.2	V
V_O	Output voltage tolerance band	0-100 % of max I_O , $V_I = 36$ V to 75 V	11.8		13.6	V
	Idling voltage	$I_O = 0$ A	12.4		13.6	V
	Line regulation	$V_I = 36$ V to 75 V		0.2	0.8	V
	Load regulation	$V_I = 53$ V, 0-100 % of max I_O	0.3	0.65	0.9	V
V_{tr}	Load transient voltage deviation	$V_I = 53$ V, Load step 50-75-50 % of max I_O , $di/dt = 1$ A/ μ s, see Note 1		0.4		V
t_{tr}	Load transient recovery time			0.25		ms
t_r	Ramp-up time (from 10-90 % of V_{Oi})	0-100 % of max I_O	2	5.5	9	ms
t_s	Start-up time (from V_I connection to 90 % of V_{Oi})		6	11	16	ms
t_f	V_I shut-down fall time (from V_{Ioff} to 10 % of V_{Oi})	max I_O		0.1		ms
		$I_O = 0$ A		0.8		s
t_{RC}	RC start-up time	max I_O		8		ms
	RC shut-down fall time (from RC off to 10 % of V_{Oi})	max I_O		0.1		ms
		$I_O = 0$ A		0.5		s
I_O	Output current		0		20	A
I_{lim}	Current limit threshold	$T_{ref} < \max T_{ref}$	21	27	33	A
C_{out}	Recommended Capacitive Load	$T_{ref} = 25$ °C	0			μ F
I_{sc}	Short circuit current	$T_{ref} = 25$ °C		29		A
V_{Oac}	Output ripple & noise	See ripple & noise section, max I_O		80	240	mVp-p
OVP	Input over voltage protection			79		V
	Output over voltage protection			13.5		

 Note 1: A 220 μ F external output capacitance was with low ESR was used.

PKB 4000B series Intermediate Bus Converters Input 36-75 V, Output up to 40 A / 252 W	EN/LZT 146 384 R3C January 2010
	© Ericsson AB

13 V, 20 A / 252 W Typical Characteristics

PKB 4207LB PI

Efficiency

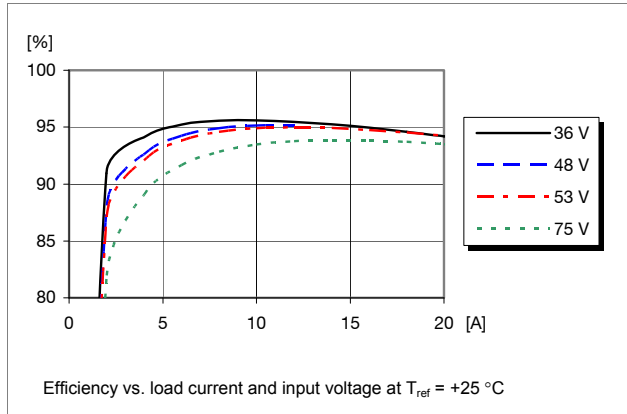

Power Dissipation

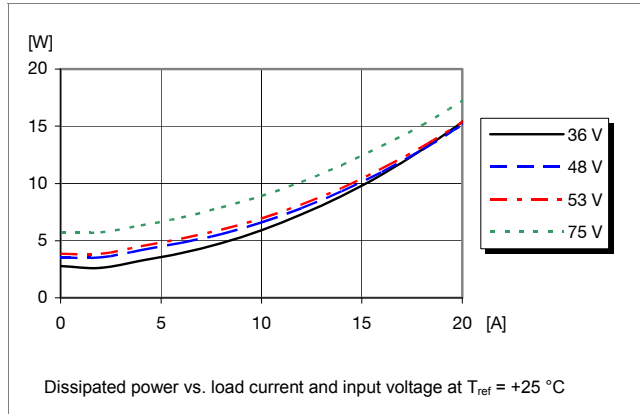

Output Current Derating, open frame

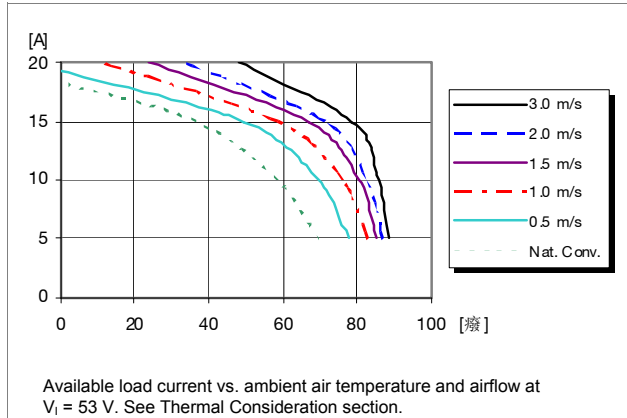

Output Current Derating, base plate option

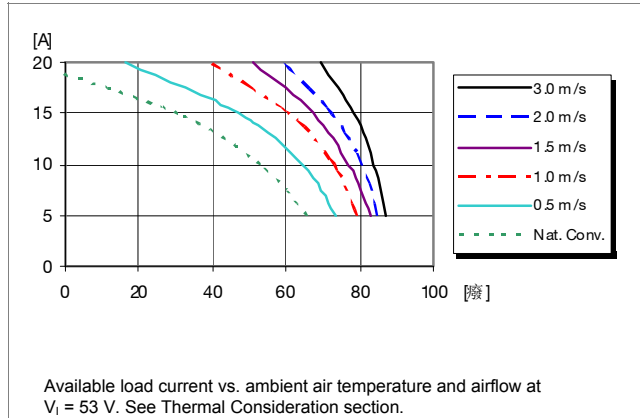

Output Characteristics

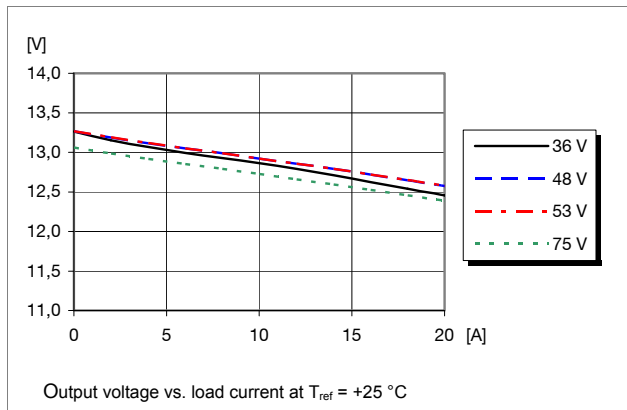

Current Limit Characteristics

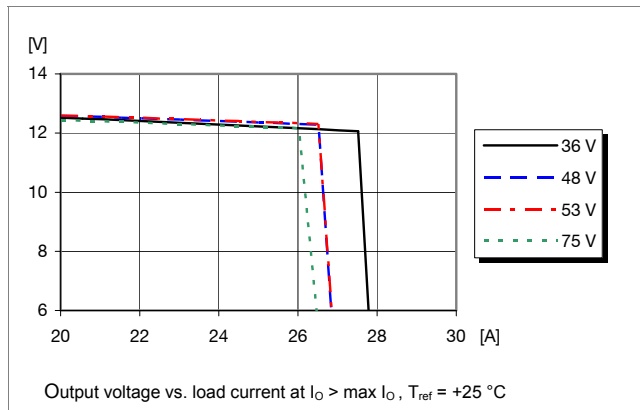

PKB 4000B series Intermediate Bus Converters
 Input 36-75 V, Output up to 40 A / 252 W

EN/LZT 146 384 R3C January 2010

© Ericsson AB

13 V, 20 A / 252 W Typical Characteristics

PKB 4207LB PI

Start-up

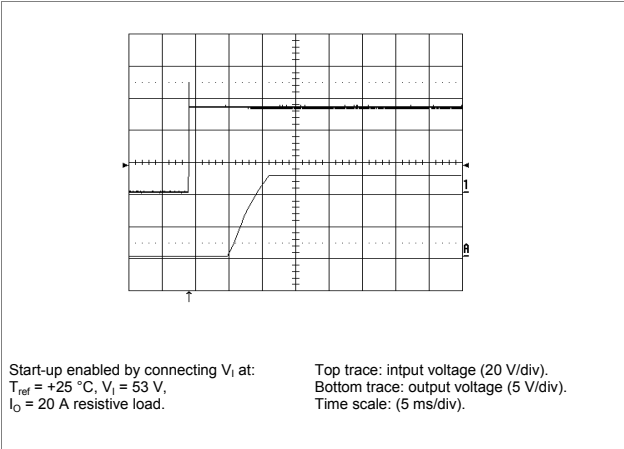

Shut-down

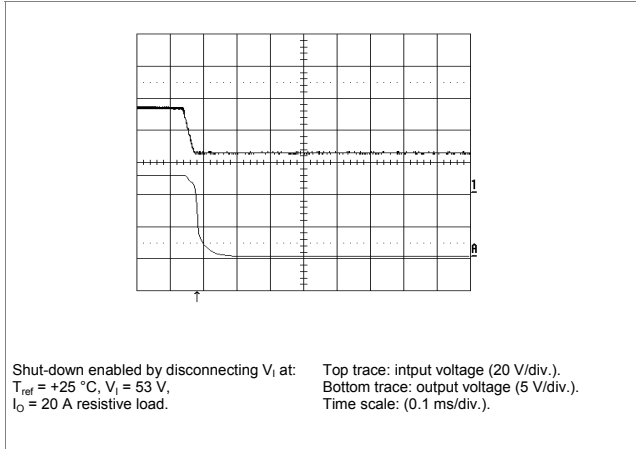

Output Ripple & Noise

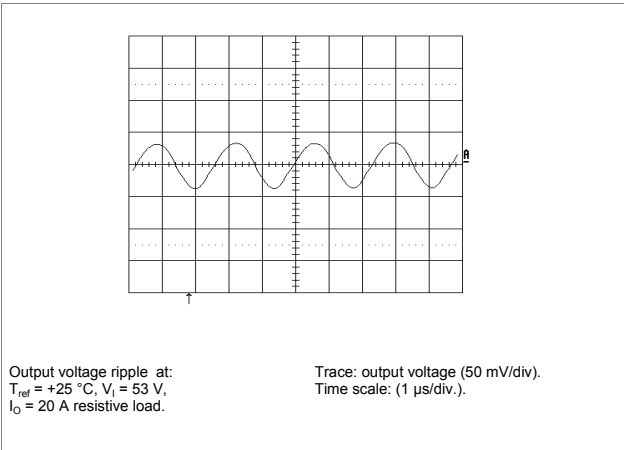

Output Load Transient Response

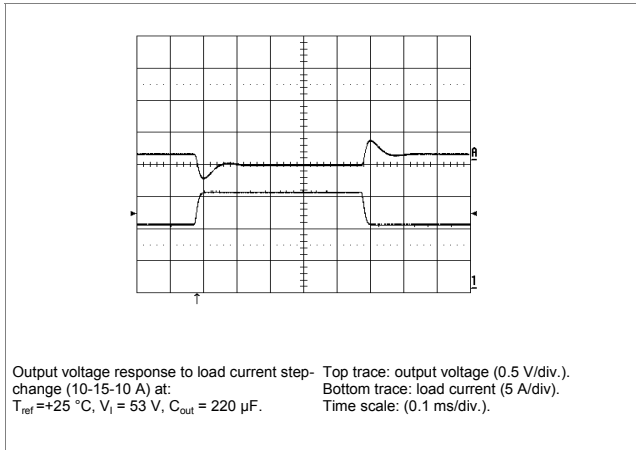

PKB 4000B series Intermediate Bus Converters Input 36-75 V, Output up to 40 A / 252 W	EN/LZT 146 384 R3C January 2010
	© Ericsson AB

EMC Specification

Conducted EMI measured according to EN55022, CISPR 22 and FCC part 15J (see test set-up). See Design Note 009 for detailed information. The fundamental switching frequency is 180 kHz for PKB 4204B PI @ $V_i = 53\text{ V}$, max I_o .

Conducted EMI Input terminal value (typ)

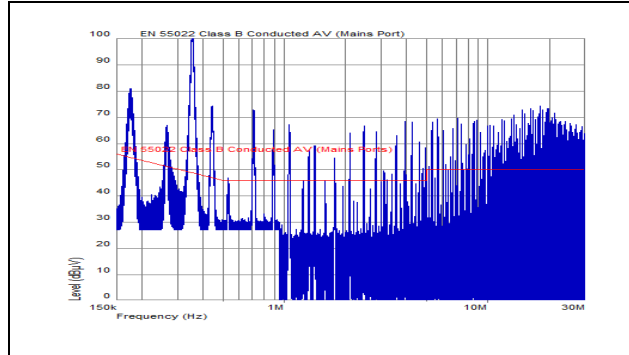

EMI without filter

External filter (class B)

Required external input filter in order to meet class B in EN 55022, CISPR 22 and FCC part 15J.

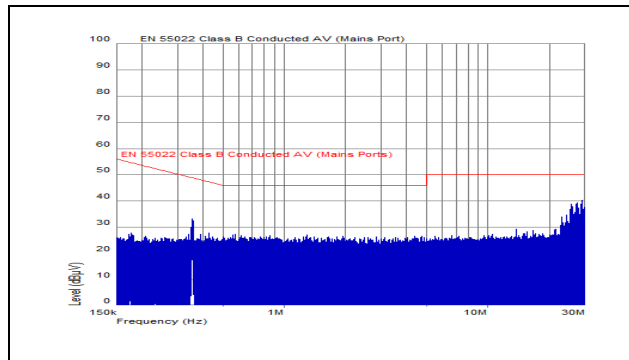
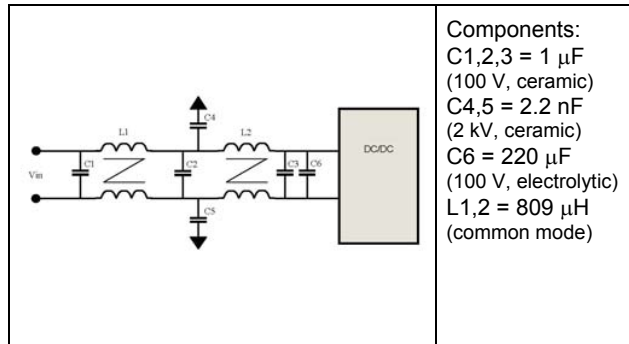

EMI with filter

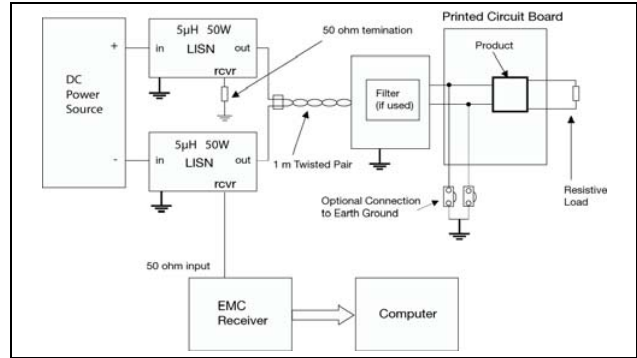

Test set-up

Layout recommendation

The radiated EMI performance of the DC/DC converter will depend on the PCB layout and ground layer design. It is also important to consider the stand-off of the DC/DC converter.

If a ground layer is used, it should be connected to the output of the DC/DC converter and the equipment ground or chassis.

A ground layer will increase the stray capacitance in the PCB and improve the high frequency EMC performance.

Output ripple and noise

Output ripple and noise measured according to figure below. See Design Note 022 for detailed information.

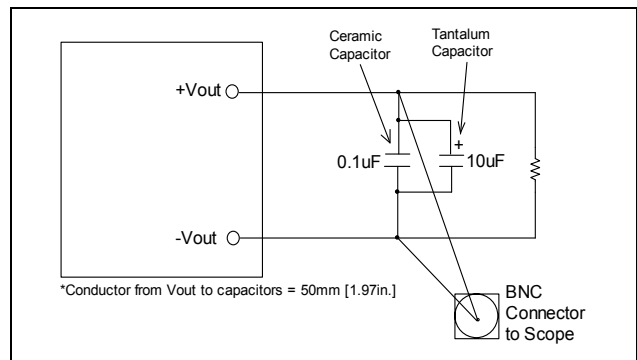

Output ripple and noise test setup

PKB 4000B series Intermediate Bus Converters

Input 36-75 V, Output up to 40 A / 252 W

EN/LZT 146 384 R3C January 2010

© Ericsson AB

Operating information

Input Voltage

The input voltage range 36 to 75 Vdc meets the requirements of the European Telecom Standard ETS 300 132-2 for normal input voltage range in -48 and -60 Vdc systems, -40.5 to -57.0 V and -50.0 to -72 V respectively. At input voltages exceeding 75 V, the power loss will be higher than at normal input voltage and T_{ref} must be limited to absolute max 125 °C. The absolute maximum continuous input voltage is 80 Vdc.

Turn-off Input Voltage

The DC/DC converters monitor the input voltage and will turn on and turn off at predetermined levels. The minimum hysteresis between on and off input voltage is 1.0 V.

Remote Control (RC)

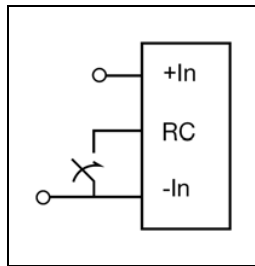

The products are fitted with a remote control function referenced to the primary negative input connection (- In), with positive logic option available. The RC function allows the product to be turned on/off by an external device like a semiconductor or mechanical switch. The RC pin has an internal pull up resistor to + In.

The maximum required sink current is less than 1 mA. When the RC pin is left open, the voltage generated on the RC pin is 5-10 V. The second option is "positive logic" remote control, which can be ordered by adding the suffix "P" to the end of the part number. The DC/DC converter will turn on when the input voltage is applied with the RC pin open. Turn off is achieved by connecting the RC pin to the - In. To ensure safe turn off the voltage difference between RC pin and the - In pin shall be less than 1 V. The DC/DC converter will restart automatically when this connection is opened.

Input and Output Impedance

The impedance of both the input source and the load will interact with the impedance of the DC/DC converter. It is important that the input source has low characteristic impedance. Minimum recommended external input capacitance is 220 μ F. The performance in some applications can be enhanced by addition of external capacitance as described under External Decoupling Capacitors.

External Decoupling Capacitors

When powering loads with significant dynamic current requirements, the voltage regulation at the point of load can be improved by addition of decoupling capacitors at the load. The most effective technique is to locate low ESR ceramic and electrolytic capacitors as close to the load as possible, using several parallel capacitors to lower the effective ESR. The ceramic capacitors will handle high-frequency dynamic load

changes while the electrolytic capacitors are used to handle low frequency dynamic load changes. Ceramic capacitors will also reduce any high frequency noise at the load. It is equally important to use low resistance and low inductance PCB layouts and cabling. The recommended absolute maximum value of output capacitance is 2 000 μ F. The user should be aware, however, that large values of capacitance will affect the ramp-up time of the DC/DC converter output voltage during start-up.

Parallel Operation

The converters can be paralleled for redundancy if external o-ring diodes are used in series with the outputs.

Over Temperature Protection (OTP)

The DC/DC converters are protected from thermal overload by an internal over temperature shutdown circuit. When T_{ref} as defined in thermal consideration section exceeds 125°C the DC/DC converter will shut down. The DC/DC converter will make continuous attempts to start up (non-latching mode) and resume normal operation automatically when the temperature has dropped below the temperature threshold.

Over Voltage Protection (OVP)

The DC/DC converters have an output over voltage protection that normally will clamp the output voltage to the OVP threshold level. If the output voltage should increase to the OVP threshold level very fast then the DC/DC converter can shut down and make attempts to start up (non-latching mode). After removal of the over voltage condition the DC/DC converter will resume to normal operation automatically.

Over Current Protection (OCP)

The DC/DC converters include current limiting circuitry for protection at continuous overload. The output voltage will decrease towards zero for output currents in excess of max output current (max I_o). The DC/DC converter will resume normal operation after removal of the overload. The load distribution should be designed for the maximum output short circuit current specified.

PKB 4000B series Intermediate Bus Converters Input 36-75 V, Output up to 40 A / 252 W	EN/LZT 146 384 R3C January 2010
	© Ericsson AB

Thermal Consideration

General

The products are designed to operate in different thermal environments and sufficient cooling must be provided to ensure reliable operation. For products mounted on a PCB without a heat sink attached cooling is achieved mainly by conduction, from the pins to the host board, and convection, which is dependant on the airflow across the product. Increased airflow enhances the cooling of the converter.

The Output Current Derating graph found in the Output section for each model provides the available output current vs. ambient air temperature and air velocity at $V_{in} = 53 V$.

The product is tested on a 254 x 254 mm, 35 μm (1 oz), 16-layer test board mounted vertically in a wind tunnel with a cross-section of 305 x 305 mm.

Proper cooling of the DC/DC converter can be verified by measuring the temperature at positions P1, P2, P3, P4 and P5. The temperature at these positions should not exceed the max values provided in the table below. The number of points may vary with different thermal design and topology.

See Design Note 019 for detailed information.

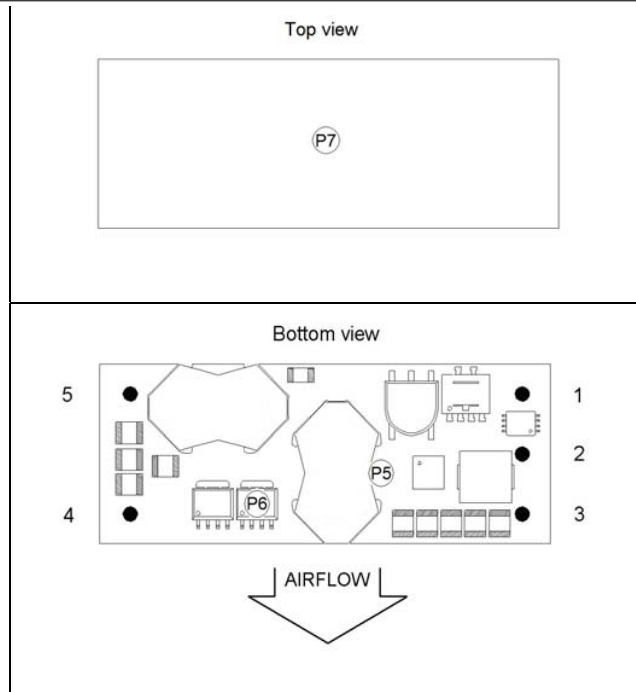

Base plate

Position	Description	Max value
P1	Reference point (T_{ref})	125 °C
P2	Transistor	125 °C
P3	Optocoupler	100 °C
P5	Reference point (T_{ref})	125 °C
P6	Transistor	125 °C
P7	Base plate	105 °C

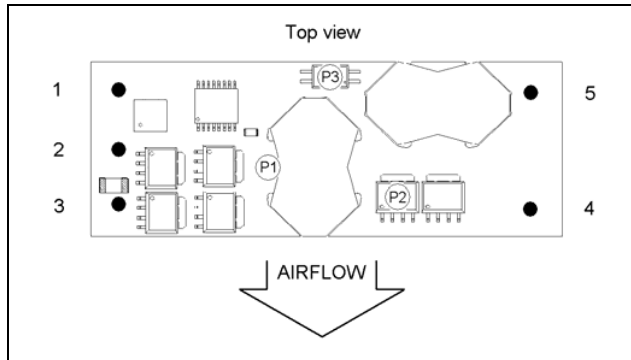

Open frame

PKB 4000B series Intermediate Bus Converters
 Input 36-75 V, Output up to 40 A / 252 W

EN/LZT 146 384 R3C January 2010

© Ericsson AB

Connections

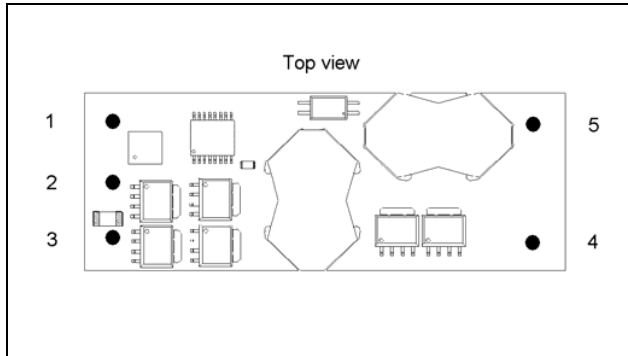

Pin	Designation	Function
1	+In	Positive input
2	RC	Remote control
3	-In	Negative input
4	-Out	Negative output
5	+Out	Positive output

PKB 400B series Intermediate Bus Converters
 Input 36-75 V, Output up to 40 A / 252 W

EN/LZT 146 384 R3C January 2010

© Ericsson AB

Mechanical Information - Hole Mount, Open Frame Version

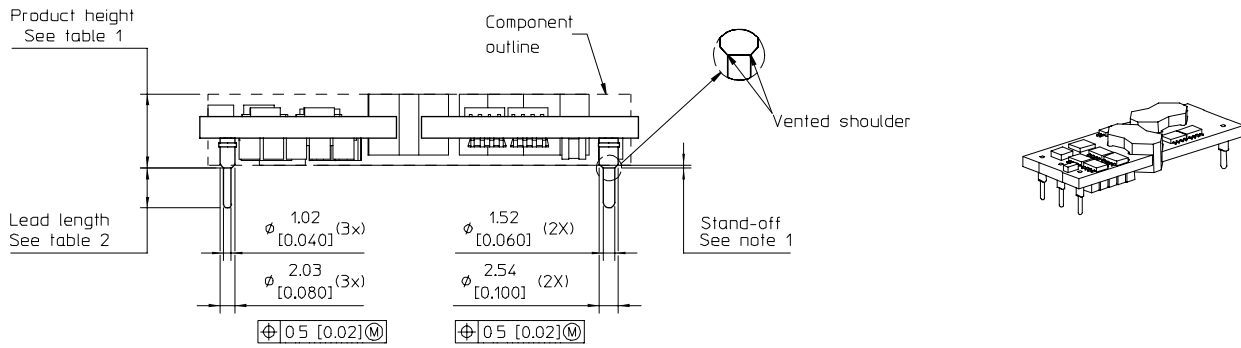

TOP VIEW
 Pin positions according to recommended footprint

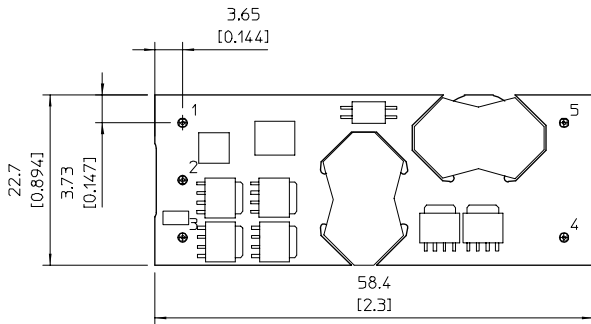

RECOMMENDED FOOTPRINT - TOP VIEW

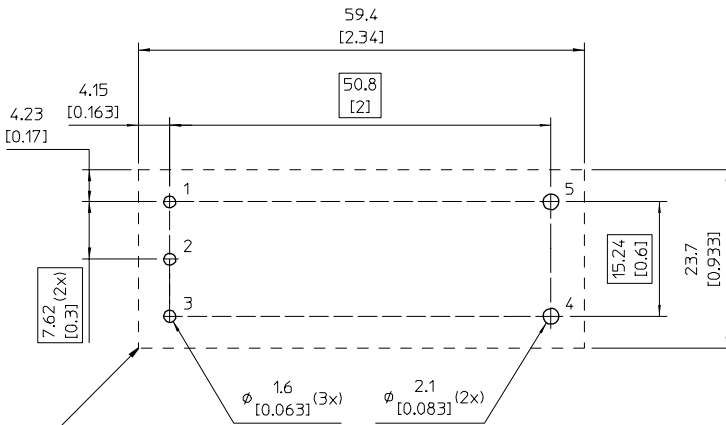

Recommended keep away area for user components
 The stand-off in combination with insulating material ensures that requirements as per IEC/EN/UL60950 are met and 1500 V isolation maintained even if open vias or traces are present under the DC/DC converter.

Table 1

Height option	Height max.
Standard	10.1 [0.397]
M	11.9 [0.468]

Table 2

Pin option	Lead length
Standard	5.33 [0.210]
LA	3.69 [0.145] cut
LB	4.57 [0.180] cut

Notes

- 1- Stand-off to non-conductive components
 min 0.1 [0.004] for Standard- option
 min 1.9 [0.075] for M- option
 Stand-off to conductive components
 min 0.9 [0.035] for Standard- option
 min 2.7 [0.106] for M- option

Pins:

Material: Copper alloy
 Plating: 0.1 μ m Gold over 2 μ m Nickel

Weight: Typical 26 g

All dimensions in mm [inch].

Tolerances unless specified

x.x \pm 0.50 [0.02], x.xx \pm 0.25 [0.01]

(not applied on footprint or typical values)



PKB 400B series Intermediate Bus Converters
 Input 36-75 V, Output up to 40 A / 252 W

EN/LZT 146 384 R3C January 2010

© Ericsson AB

Mechanical Information - Hole Mount, Base Plate Version

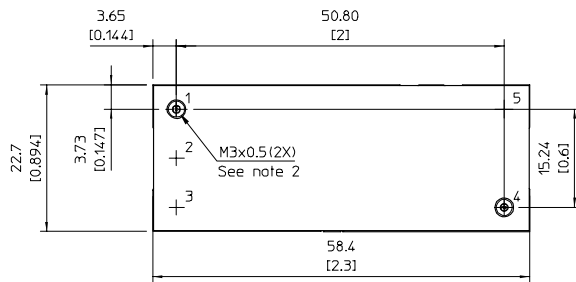
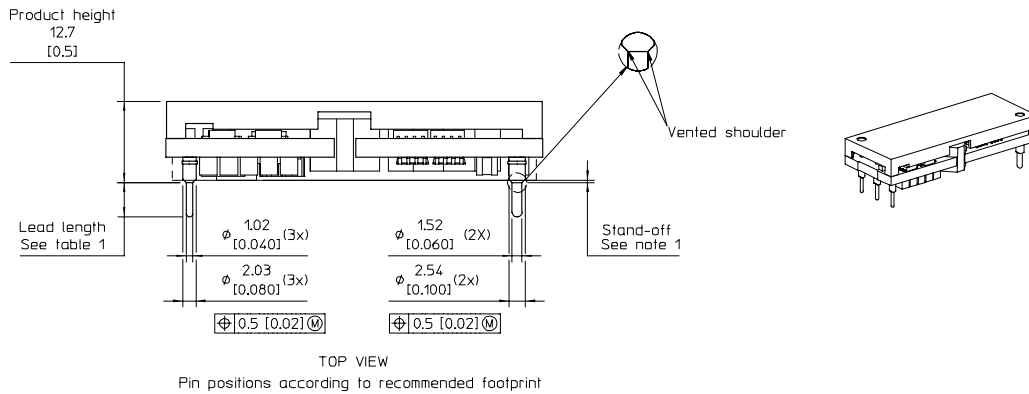
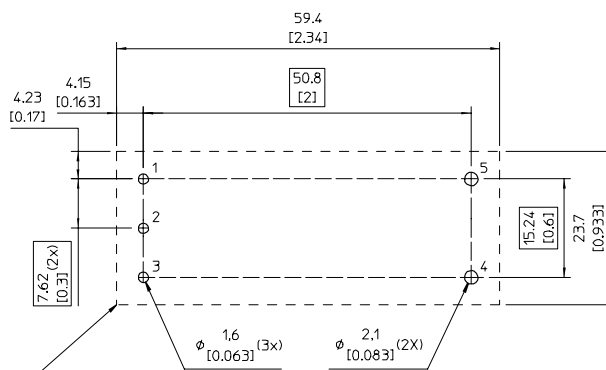

Table 1

Pin option	Lead length
Standard	5.33 [0.210]
LA	3.69 [0.145] cut
LB	4.57 [0.180] cut

RECOMMENDED FOOTPRINT - TOP VIEW



Recommended keep away area for user components
 The stand-off in combination with insulating material ensures that requirements as per IEC/EN/UL60950 are met and 1500 V isolation maintained even if open vias or traces are present under the DC/DC converter.

Notes

- 1- Stand-off to non-conductive components min 0.1 [0.004]
 Stand-off to conductive components min 0.9 [0.035]
- 2- For screw attachment apply mounting torque of max 0.44 Nm [3.9 lbf in].
 - M3 screws must not protrude more than 2.7 [0.106] into the base plate.

Case:

Material: Aluminium alloy
 Pins:
 Material: Copper alloy
 Plating: 0,1 µm Gold over 2 µm Nickel

Weight: Typical 45 g
 All dimensions in mm [inch].
 Tolerances unless specified
 x.x +0.50 [0.02], x.xx +0.25 [0.01]
 (not applied on footprint or typical values)



PKB 400B series Intermediate Bus Converters
 Input 36-75 V, Output up to 40 A / 252 W

EN/LZT 146 384 R3C January 2010

© Ericsson AB

Mechanical Information - Surface Mount Version

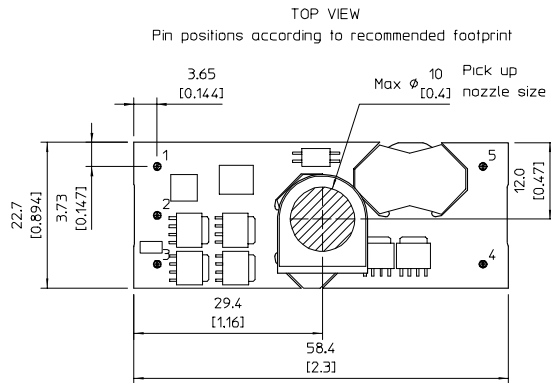
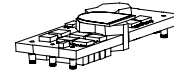
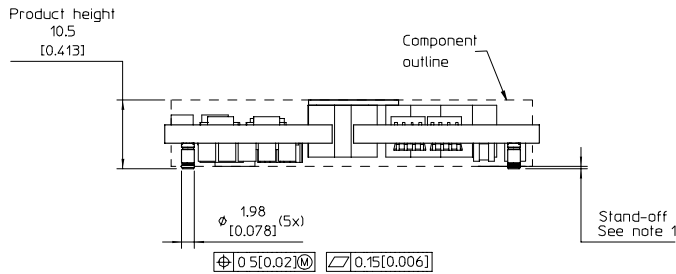

RECOMMENDED FOOTPRINT - TOP VIEW

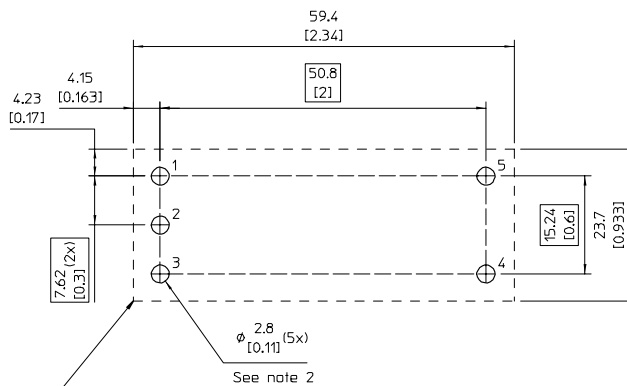

Recommended keep away area for user components

The stand-off in combination with insulating material ensures that requirements as per IEC/EN/UL60950 are met and 1500 V isolation maintained even if open vias or traces are present under the DC/DC converter.

Notes

1- Stand-off to non-conductive components
 min 0.1 [0.004]
 Stand-off to conductive components
 min 0.9 [0.035]

2- Layout considerations
 Use sufficient numbers of vias connected to output pin pads for optimal thermal and current connectivity.

Pins:
 Material: Copper alloy
 Plating: 0.1 μ m Gold over 2 μ m Nickel

Weight: Typical 26 g
 All dimensions in mm [inch].
 Tolerances unless specified
 x.x ± 0.50 [0.02], x.xx ± 0.25 [0.01]
 (not applied on footprint or typical values)



PKB 400B series Intermediate Bus Converters
 Input 36-75 V, Output up to 40 A / 252 W

EN/LZT 146 384 R3C January 2010

© Ericsson AB

Soldering Information - Surface Mounting

The surface mount product is intended for forced convection or vapor phase reflow soldering in SnPb and Pb-free processes.

The reflow profile should be optimised to avoid excessive heating of the product. It is recommended to have a sufficiently extended preheat time to ensure an even temperature across the host PCB and it is also recommended to minimize the time in reflow.

A no-clean flux is recommended to avoid entrapment of cleaning fluids in cavities inside the product or between the product and the host board, since cleaning residues may affect long time reliability and isolation voltage.

Minimum Pin Temperature Recommendations

Pin number 4 is chosen as reference location for the minimum pin temperature recommendation since this will likely be the coolest solder joint during the reflow process.

SnPb solder processes

For SnPb solder processes, a pin temperature (T_{PIN}) in excess of the solder melting temperature, (T_L , 183°C for Sn63Pb37) for more than 30 seconds and a peak temperature of 210°C is recommended to ensure a reliable solder joint.

For dry packed products only: depending on the type of solder paste and flux system used on the host board, up to a recommended maximum temperature of 245°C could be used, if the products are kept in a controlled environment (dry pack handling and storage) prior to assembly.

Lead-free (Pb-free) solder processes

For Pb-free solder processes, a pin temperature (T_{PIN}) in excess of the solder melting temperature (T_L , 217 to 221°C for SnAgCu solder alloys) for more than 30 seconds and a peak temperature of 235°C on all solder joints is recommended to ensure a reliable solder joint.

Maximum Product Temperature Requirements

Top of the product PCB near pin 2 is chosen as reference location for the maximum (peak) allowed product temperature ($T_{PRODUCT}$) since this will likely be the warmest part of the product during the reflow process.

SnPb solder processes

For SnPb solder processes, the product is qualified for MSL 1 according to IPC/JEDEC standard J-STD-020C.

During reflow $T_{PRODUCT}$ must not exceed 225 °C at any time.

Pb-free solder processes

For Pb-free solder processes, the product is qualified for MSL 3 according to IPC/JEDEC standard J-STD-020C.

During reflow $T_{PRODUCT}$ must not exceed 260 °C at any time.

Dry Pack Information

Products intended for Pb-free reflow soldering processes are delivered in standard moisture barrier bags according to IPC/JEDEC standard J-STD-033 (Handling, packing, shipping and use of moisture/reflow sensitivity surface mount devices).

Using products in high temperature Pb-free soldering processes requires dry pack storage and handling. In case the products have been stored in an uncontrolled environment and no longer can be considered dry, the modules must be baked according to J-STD-033.

General reflow process specifications		SnPb eutectic	Pb-free
Average ramp-up ($T_{PRODUCT}$)		3°C/s max	3°C/s max
Typical solder melting (liquidus) temperature	T_L	183°C	221°C
Minimum reflow time above T_L		30 s	30 s
Minimum pin temperature	T_{PIN}	210°C	235°C
Peak product temperature	$T_{PRODUCT}$	225°C	260°C
Average ramp-down ($T_{PRODUCT}$)		6°C/s max	6°C/s max
Maximum time 25°C to peak		6 minutes	8 minutes

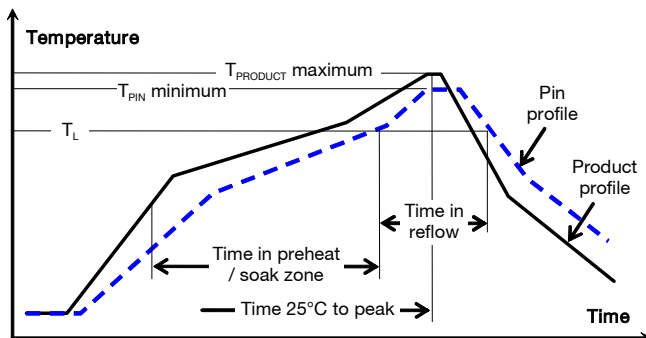

Thermocouple Attachment

Top of PCB near pin 2 for measurement of maximum product temperature, $T_{PRODUCT}$

TOP VIEW

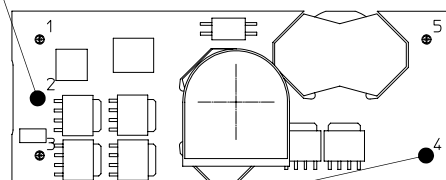

Pin 4 for measurement of minimum pin (solder joint) temperature, T_{PIN}

PKB 400B series Intermediate Bus Converters
Input 36-75 V, Output up to 40 A / 252 W

EN/LZT 146 384 R3C January 2010
© Ericsson AB

Soldering Information - Hole Mounting

The hole mounted product is intended for plated through hole mounting by wave or manual soldering. The pin temperature is specified to maximum to 270°C for maximum 10 seconds.

A maximum preheat rate of 4°C/s and maximum preheat temperature of 150°C is suggested. When soldering by hand, care should be taken to avoid direct contact between the hot soldering iron tip and the pins for more than a few seconds in order to prevent overheating.

A no-clean flux is recommended to avoid entrapment of cleaning fluids in cavities inside the product or between the product and the host board. The cleaning residues may affect long time reliability and isolation voltage.

Delivery Package Information

Surface Mount Version

The products are delivered in antistatic injection molded trays (Jedec design guide 4.10D standard).

Delivery Package Information

Hole Mount, Open Frame version

Hole Mount, Base Plate version

The products are delivered in antistatic trays.

Tray Specifications	
Material	PE Foam
Surface resistance	$10^5 < \text{Ohm/square} < 10^{12}$
Bakability	The trays are not bakeable
Tray thickness	22 mm [0.87 inch]
Box capacity	75 products (3 full trays/box)
Tray weight	Open frame version 40 g empty, 690 g full tray Base plate version 40 g empty, 1165 g full tray

Tray Specifications	
Material	Antistatic PPE
Surface resistance	$10^5 < \text{Ohm/square} < 10^{12}$
Bakability	The trays can be baked at maximum 125°C for 48 hours
Tray thickness	17.4 mm [0.685 inch]
Box capacity	100 products (5 full trays/box)
Tray weight	120 g empty, 640 g full tray

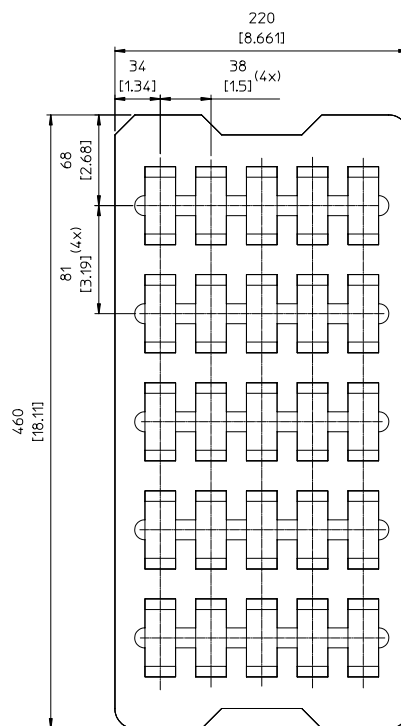
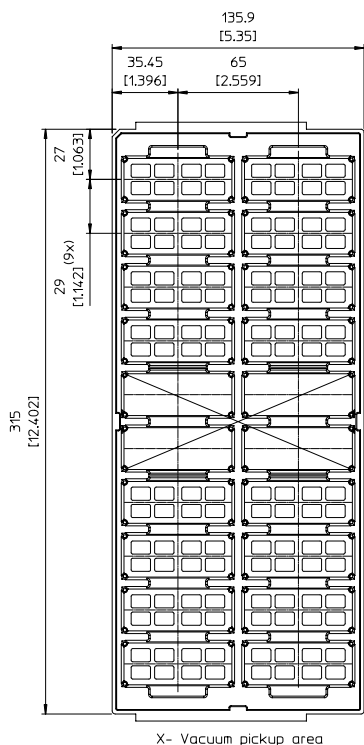

PKB 4000B series Intermediate Bus Converters Input 36-75 V, Output up to 40 A / 252 W	EN/LZT 146 384 R3C January 2010
	© Ericsson AB

Product Qualification Specification

Characteristics			
External visual inspection	IPC-A-610		
Change of temperature (Temperature cycling)	IEC 60068-2-14 Na	Temperature range Number of cycles Dwell/transfer time	-40 to 100°C 1000 15 min/0-1 min
Cold (in operation)	IEC 60068-2-1 Ad	Temperature T _A Duration	-45°C 72 h
Damp heat	IEC 60068-2-67 Cy	Temperature Humidity Duration	85°C 85 % RH 1000 hours
Dry heat	IEC 60068-2-2 Bd	Temperature Duration	125°C 1000 h
Electrostatic discharge susceptibility	IEC 61340-3-1, JESD 22-A114 IEC 61340-3-2, JESD 22-A115	Human body model (HBM) Machine Model (MM)	Class 2, 2000 V Class 3, 200 V
Immersion in cleaning solvents	IEC 60068-2-45 XA, method 2	Water Glycol ether Isopropyl alcohol	55°C 35°C 35°C
Mechanical shock	IEC 60068-2-27 Ea	Peak acceleration Duration	100 g 6 ms
Moisture reflow sensitivity ¹	J-STD-020C	Level 1 (SnPb-eutectic) Level 3 (Pb Free)	225°C 260°C
Operational life test	MIL-STD-202G, method 108A	Duration	1000 h
Resistance to soldering heat ²	IEC 60068-2-20 Tb, method 1A	Solder temperature Duration	270°C 10-13 s
Robustness of terminations	IEC 60068-2-21 Test Ua1 IEC 60068-2-21 Test Ue1	Through hole mount products Surface mount products	All leads All leads
Solderability	IEC 60068-2-58 test Td ¹	Preconditioning Temperature, SnPb Eutectic Temperature, Pb-free	150°C dry bake 16 h 215°C 235°C
	IEC 60068-2-20 test Ta ²	Preconditioning Temperature, SnPb Eutectic Temperature, Pb-free	Steam ageing 235°C 245°C
Vibration, broad band random	IEC 60068-2-64 Fh, method 1	Frequency Spectral density Duration	10 to 500 Hz 0.07 g ² /Hz 10 min in each direction

Notes

¹ Only for products intended for reflow soldering (surface mount products)

² Only for products intended for wave soldering (plated through hole products)