

Features

ICE Technology*

- Up to 89°C Ambient, no derating (40W)
- 120°C Maximum Case Temperature
- -45°C Minimum Temp. (optional: -55°C)
- Built-in FCC/EN55022 Class B Filter
- 2:1 Wide Input Voltage Range
- 40 Watts Output Power
- Ribbed, Flat or Baseplate Case Styles
- Efficiency to 92%
- 3kVDC Isolation
- Fully Protected
- Low Quiescent Current

Description

The RPP40 series 2:1 input range DC/DC converters are ideal for high end industrial applications and COTS Military applications where a very wide operating temperature range of -45°C to +120°C is required. The converters are also optionally available with a -55°C start-up temperature. Although the case size is very compact, the converter contains a built-in filter EN55022 Class B / FCC Level B without the need for any external components. The RPP is available in three case styles: the high operating temperature ribbed case, the low profile flat case and the baseplate case for high vibration or bulkhead-mounting applications. They are UL-60950-1 certified.

Selection Guide 24V and 48V Input Types

| Part Number | Input Range VDC | Output Voltage VDC | Output Current A | Input ⁽¹⁾ Current mA | Efficiency ⁽²⁾ (Typ.) | Max ⁽³⁾ Operating Temp |
|--------------|-----------------|--------------------|------------------|---------------------------------|----------------------------------|-----------------------------------|
| RPP40-243.3S | 18-36 | 3.3 | 12 | 58/1885 | 88.4% | 77°C |
| RPP40-2405S | 18-36 | 5 | 8 | 60/1831 | 91.0% | 86°C |
| RPP40-2412S | 18-36 | 12 | 3.33 | 100/1875 | 87.8% | 75°C |
| RPP40-2415S | 18-36 | 15 | 2.67 | 100/1870 | 89.5% | 81°C |
| RPP40-2424S | 18-36 | 24 | 1.67 | 100/1870 | 89.5% | 81°C |
| RPP40-483.3S | 36-75 | 3.3 | 12 | 42/923 | 90.2% | 84°C |
| RPP40-4805S | 36-75 | 5 | 8 | 37/906 | 92.0% | 89°C |
| RPP40-4812S | 36-75 | 12 | 3.33 | 5/930 | 88.9% | 78°C |
| RPP40-4815S | 36-75 | 15 | 2.67 | 5/930 | 89.7% | 81°C |
| RPP40-4824S | 36-75 | 24 | 1.67 | 5/930 | 89.7% | 81°C |
| RPP40-2412D | 18-36 | ±12 | ±1.67 | 100/1870 | 88.4% | 86°C |
| RPP40-2415D | 18-36 | ±15 | ±1.33 | 100/1870 | 89.8% | 89°C |
| RPP40-2424D | 18-36 | ±24 | ±0.84 | 100/1870 | 89.8% | 91°C |
| RPP40-4812D | 36-75 | ±12 | ±1.67 | 5/930 | 88.8% | 87°C |
| RPP40-4815D | 36-75 | ±15 | ±1.33 | 5/930 | 89.7% | 94°C |
| RPP40-4824D | 36-75 | ±24 | ±0.84 | 5/930 | 89.7% | 94°C |

** add suffixes for case, temperature or CTRL logic options.

SUFFIX INFORMATION

none = Standard Ribbed Case

-B = Baseplate Case

-F = Flat Case

-L = Low Temp (-55°C) Ribbed Case

-M = Low Temp (-55°C) Baseplate Case

-T = Low Temp (-55°C) Flat Case

add "1" before suffix for neg. CTRL logic
e.g. -1, -1B, -1F, etc.

POWERLINE+

DC/DC-Converter

with 3 year Warranty

RECOM

40 Watt

2:1 Single &

Dual Output

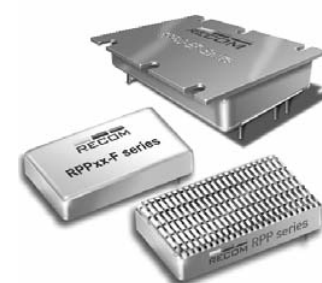

UL-60950-1 Certified
E224736

RPP40

* ICE Technology

ICE (Innovation in Converter Excellence) uses state-of-the-art techniques to minimise internal power dissipation and to increase the internal temperature limits to extend the ambient operating temperature range to the maximum. Refer to Application Notes

Derating Graph (Ambient Temperature)

RPP40-4805S

Derating graphs are valid only for the shown part numbers. Please contact Technical Support for more information info@recom-development.at

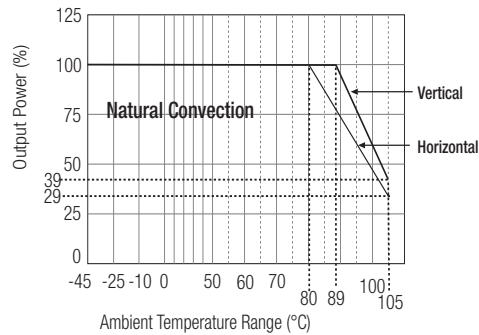

Specifications (typical at nominal input and 25°C unless otherwise noted)

| | | | |
|---|---|--------------------------|---------|
| Input Voltage Range | 24V nominal input | 18-36VDC | |
| | 48V nominal input | 36-75VDC | |
| Under Voltage Lockout | 24V input | DC-DC ON (min.) | 17.5VDC |
| | | DC-DC OFF (max.) | 17VDC |
| | 48V input | DC-DC ON (min.) | 35VDC |
| | | DC-DC OFF (max.) | 34VDC |
| Input Filter | Common Mode EMC Filter | | |
| Input Voltage Variation dv/dt (Complies with ETS300 132 part 4.4) | 5V/ms max | | |
| Input Surge Voltage (100 ms max.) | 24V Input | 50VDC | |
| | 48V Input | 100VDC | |
| Input Reflected Ripple | nominal Vin and full load | 30mA _{p-p} | |
| Start Up Time | nominal Vin and constant resistor load | 2ms typ., 5ms max. | |
| Remote ON/OFF ⁽⁴⁾ | Logic High | Open or 3.0V < Vr < 5.5V | |
| | Logic Low | Short or 0V < Vr < 1.2V | |
| Remote OFF input current | Nominal input | 2mA typ. | |
| Output Power | 50W max. | | |
| Output Voltage Accuracy | 10% Load and nominal Vin | ±1% | |
| Voltage Adjustability | ±10% | | |
| Minimum Load | 0% | | |
| Line Regulation | low line, high line at full load | ±0.3% | |
| Load Regulation | 10% to 100% full load | ±0.5% | |
| Ripple and Noise (20MHz bandwidth limited) (measured with 1µF capacitor across output) | 3.3V, 5V | 60mV _{p-p} typ. | |
| | All others | 40mV _{p-p} typ. | |
| Temperature Coefficient | ±0.04%/°C max. | | |
| Transient Response | 25% load step change | 200µs | |
| Over Load Protection | % of full load at nominal Vin | 120% typ. | |
| Short Circuit Protection | Hiccup, automatic recovery | | |
| Output Over Voltage Protection (refer to block diagram in Application Notes) | Converter shutdown if Vout > Vout nominal + 20% | | |
| Isolation Voltage | Rated at 2250VDC/1 minute, Flash tested at 3000VDC/1 second | | |
| Isolation Resistance | 10MΩ min. | | |
| Isolation Capacitance (refer to block diagram in Application Notes) | 3000pF max. | | |
| Operating Frequency | 260kHz ± 40kHz Maximum | | |
| Case Temperature | +120°C | | |
| Storage Temperature Range | -55°C to +125°C | | |
| Over Temperature Protection (refer to block diagram in Application Notes) | internal thermistor | | |

Specifications (typical at nominal input and 25°C unless otherwise noted)

| | | |
|--|--|--|
| RPP40 Operating Temperature Range | Ambient, Free Convection -55°C Version | -45°C to +87°C max (without derating) -55°C to +87°C max (without derating) |
| RPP50 Operating Temperature Range | Ambient, Free Convection -55°C Version | -45°C to +81°C max (without derating) -55°C to +81°C max (without derating) |
| Thermal Impedance (Natural convection) | Ribbed Case: Vertical Ribbed Case: Horizontal | 7.3°C/Watt 10°C/Watt |
| Relative Humidity | | 5% to 95% RH |
| Case Material ⁽⁷⁾ | | Aluminium |
| Potting Material | | Silicone (UL94-V0) |
| Weight | Ribbed Case Flat Case Basrplate Case | 39g 34g 43g |
| Packing Quantity | Ribbed and Flat Case Baseplate Case | 4 pcs per Tube Single Packed |
| Safety Standards | | certified UL-60950-1, 1st Edition |
| Thermal Cycling | | complies with MIL-STD-810F |
| Vibration | | 10-55Hz, 12G, 30 Min. along X, Y and Z |
| Conducted Emissions | EN55022 | Class B |
| Radiated Emissions | EN55022 | Class B |
| ESD | EN61000-4-2 | Perf. Criteria B |
| Radiated Immunity | EN61000-4-3 | Perf. Criteria A |
| Fast Transient ⁽⁵⁾ | EN61000-4-4 | Perf. Criteria B |
| Surge ⁽⁵⁾ | EN61000-4-5 | Perf. Criteria B |
| Conducted Immunity | EN61000-4-6 | Perf. Criteria A |
| MTBF calculated according to BELLCORE TR-NWT-000332 ⁽⁶⁾ | | 1989 x 10 ³ hours |

Notes :

1. Typical values at nominal input voltage and no load/full load.
2. Typical values at nominal input voltage and full load.
3. Typical values for ribbed case at nominal input voltage and full load in vertical orientation and with Eurocard-sized PCB ground planes to assist in heat dissipation. For horizontal orientation, reduce the maximum temperatures by 10°C.
4. The ON/OFF pin voltage is referenced to negative input. The pin is pulled high internally.
ON/OFF control is standard with positive logic: e.g. RPP40-2405SW, RPP50-4805S-B.
Add "1" before the suffix for negative logic: e.g. RPP40-2405SW-1, RPP50-4805S-1B.
Positive logic: 0= OFF, 1 = ON. The converter will be ON if the CTRL is left open.
Negative logic: 1 = OFF, 0 = ON. The converter will be OFF if the CTRL is left open.
5. Requires an external 100µF/100V low ESR capacitor to meet EN61000-4-4 and EN61000-4-5
6. Case I: 50% Stress, Temperature at 50°C (Ground Benign).
7. To ensure a good all-round electrical contact, the baseplate is pressed firmly into place within the aluminium housing. The hydraulic press can leave tooling marks and deformations to both the housing and baseplate. The case is anodised aluminium, so there will be natural variations in the case colour and the aluminium is not scratch resistant. Any resultant marks, scratches and colour variations are cosmetic only and do not affect the operation or performance of the converters.

RPP40

External Output Trimming

Refer to Application Notes for suggested Resistor Values

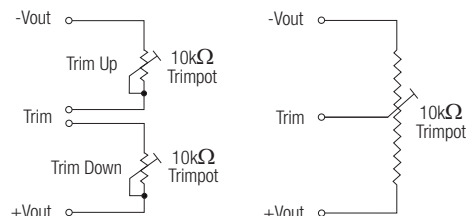

Typical Characteristics

RPP40-4805S

Efficiency VS Input Voltage

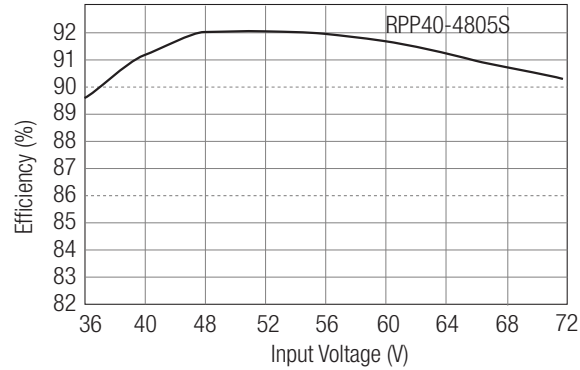

Recommended PCB Layout

Single Output

Dual Output

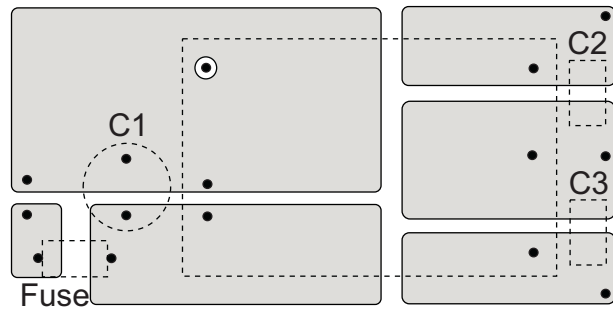
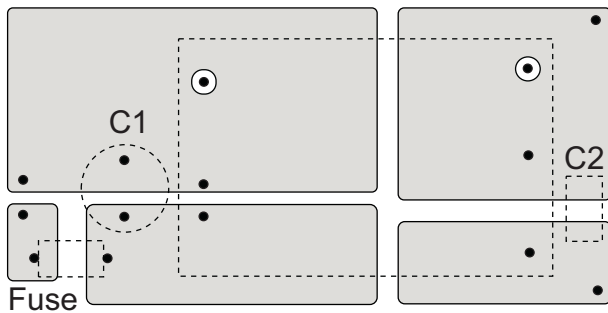

RPP40

Baseplate Case- suggested PCB layout (dual output)

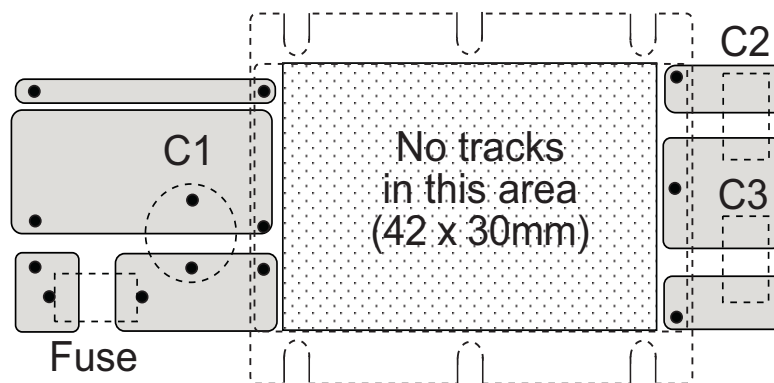

Input Fuse is recommended, but optional. Recommended fuse rating = double maximum input current, time delay type.

Input Capacitor, C1, is required to meet EN61000 Surge and Fast Transient, otherwise it is not required for normal operation.

Output Capacitors C2/C3 are recommended, but not required for normal operation. Typical capacitor values are 1µF/100V MLCC

To ensure optimum thermal performance, use large areas of copper on the PCB to assist with heat dissipation and mount the converter vertically.

POWERLINE+

DC/DC-Converter

RPP40-S_D Series

Package Style and Pinning (mm)

Ribbed Case (Standard - no Suffix)
 (Low temperature version = suffix -L)

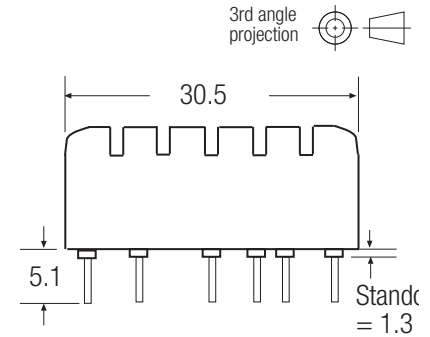
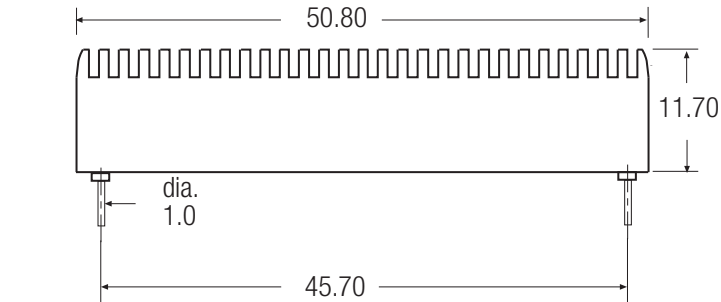

3rd angle projection

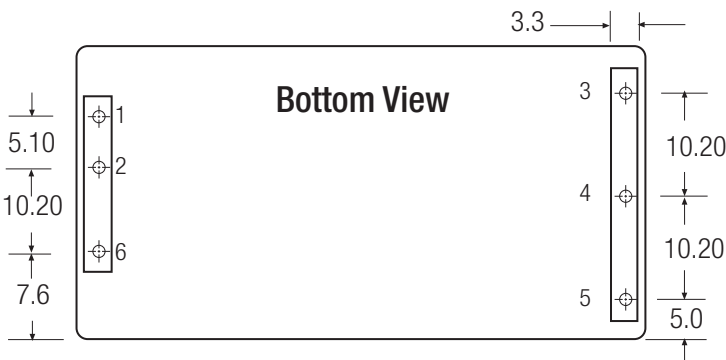

Pin Connections

| Pin # | Single | Dual |
|-------|--------|-------|
| 1 | +Vin | +Vin |
| 2 | -Vin | -Vin |
| 3 | +Vout | +Vout |
| 4 | -Vout | Com |
| 5 | Trim | -Vout |
| 6 | CTRL | CTRL |

Pin Pitch Tolerance ± 0.35 mm

Flat Case (-F Suffix)
 (Low temperature version = suffix -T)

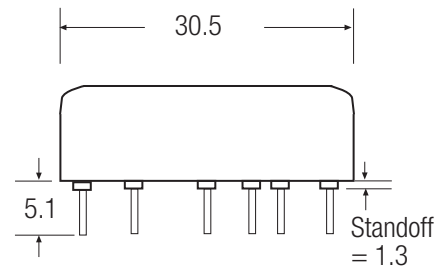
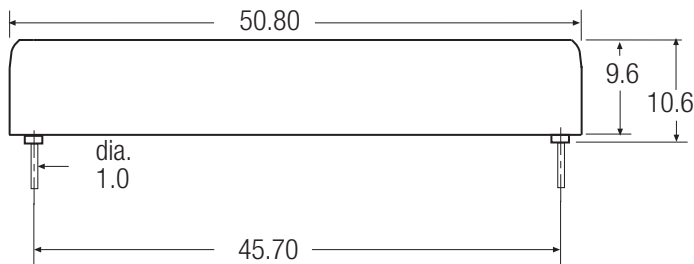

3rd angle projection

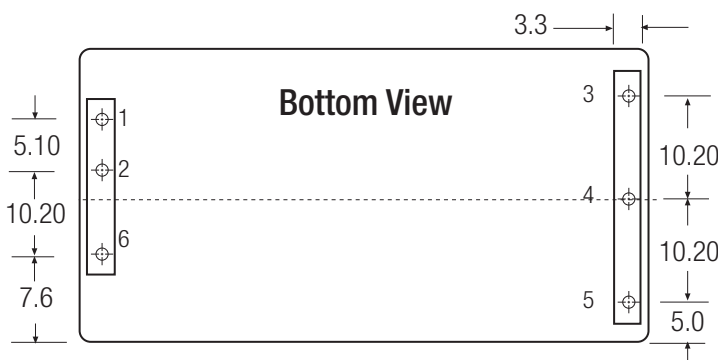

Pin Connections

| Pin # | Single | Dual |
|-------|--------|-------|
| 1 | +Vin | +Vin |
| 2 | -Vin | -Vin |
| 3 | +Vout | +Vout |
| 4 | -Vout | Com |
| 5 | Trim | -Vout |
| 6 | CTRL | CTRL |

Pin Pitch Tolerance ± 0.35 mm

RPP40

POWERLINE+

DC/DC-Converter

Typical Characteristics

RPP40-S_D Series

Baseplate Case (-B Suffix)
(Low temperature version = suffix -M)

3rd angle projection 

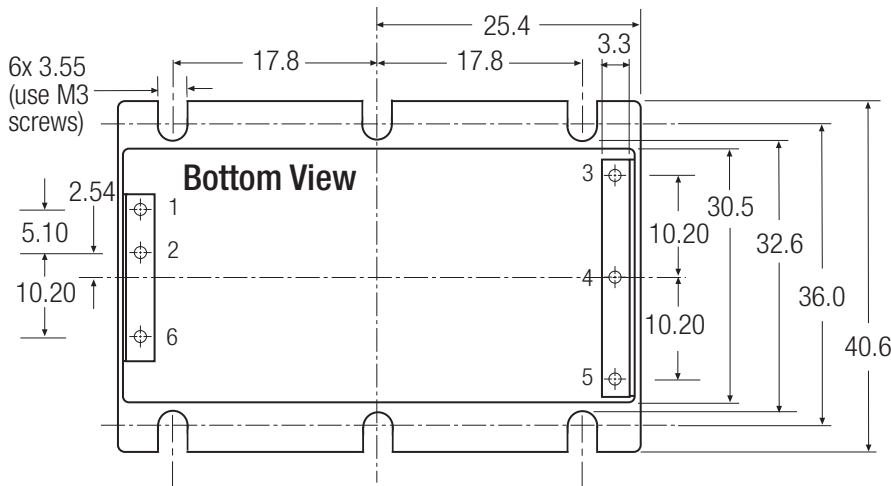
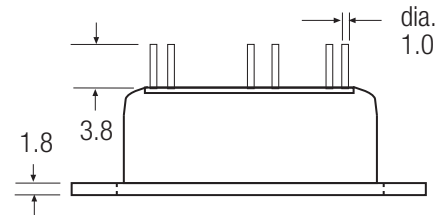
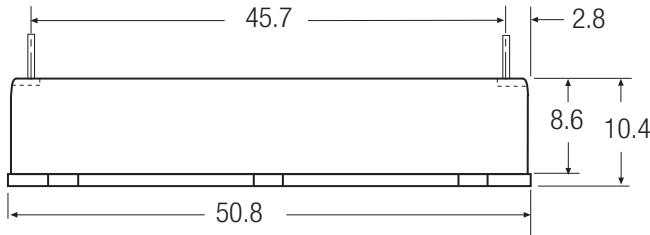

Pin Connections

| Pin # | Single | Dual |
|-------|--------|-------|
| 1 | +Vin | +Vin |
| 2 | -Vin | -Vin |
| 3 | +Vout | +Vout |
| 4 | Trim | Com |
| 5 | -Vout | -Vout |
| 6 | CTRL | CTRL |

Pin Pitch Tolerance ± 0.35 mm

RPP40

Baseplate Case Fixing - Mounting onto Heatsink/Bulkhead

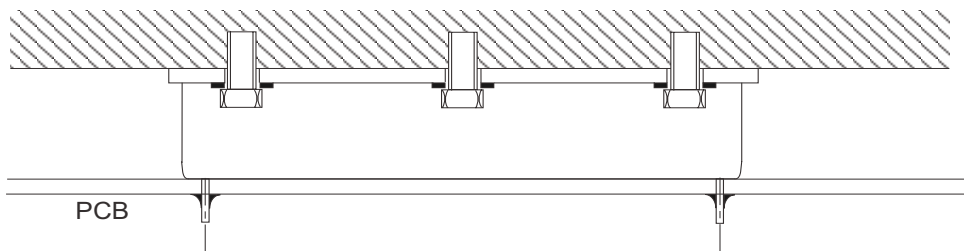

Baseplate Case Fixing - Anti Vibration Mounting onto PCB

