

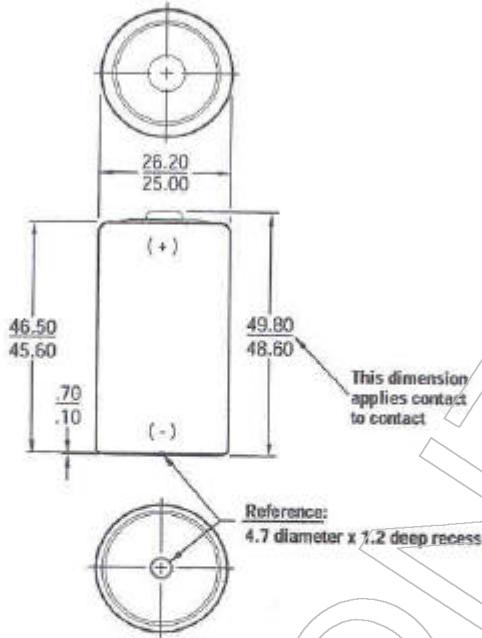

Eveready Battery Company, Inc.  
 Checkerboard Square  
 St. Louis, MO 63164  
 Telephone: 1-800-383-7323  
 Internet: www.energizer.com

## Engineering Data

### EVEREADY NO. 935



**C**  
 Zinc Chloride 1.5V  
 Classic  
 No Added Mercury or Cadmium

**Chemical System:** Zinc-Manganese Dioxide (Zn/MnO<sub>2</sub>)  
**Designation:** ANSI-14F, IEC-R14  
**Battery Voltage:** 1.5 Volts  
**Average Weight:** 47 grams (1.5 oz.)  
**Volume:** 25 cubic centimeters (1.5 cubic inch)  
**Average Service Capacity (to 0.8 Volt / cell):** 1.8 Ah  
 (Rated capacity at 25 mA continuous drain)  
**Cells:** One No. 35 (size "C")  
**Jacket:** Plastic Laminated Paper

Dimensions (mm)

Millimeters	Inches
.10	.004
.70	.028
1.20	.047
4.70	.185
25.00	.984
26.20	1.031
45.60	1.795
46.50	1.831
48.60	1.913
49.80	1.961

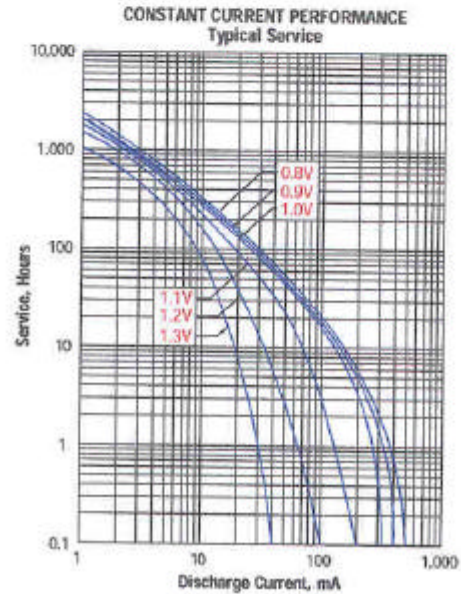
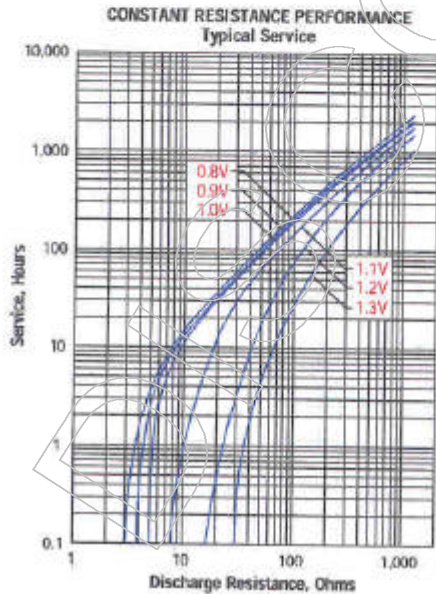

TYPICAL APPLICATIONS

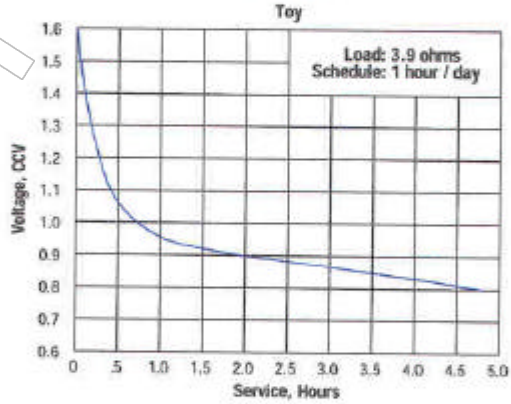
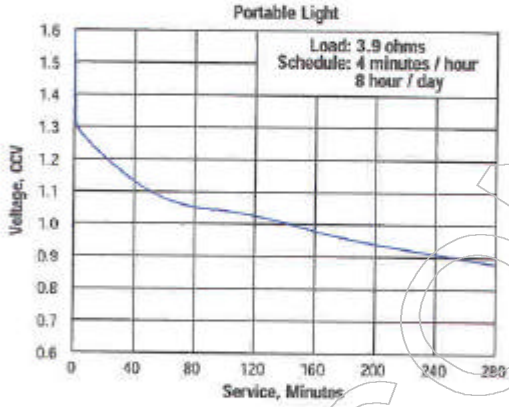
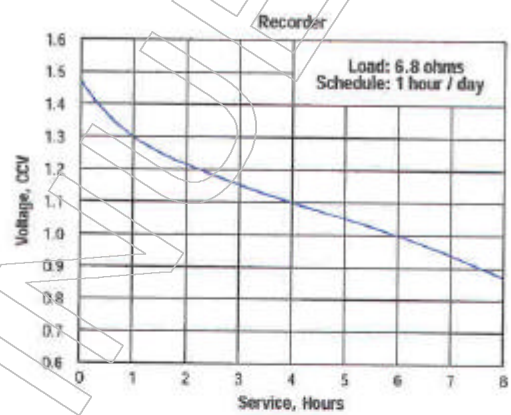
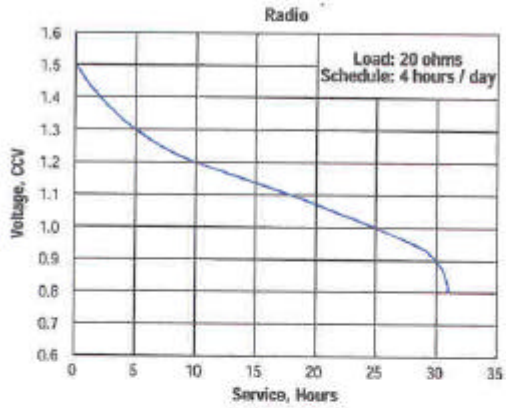

**IMPORTANT NOTICE**

This data sheet contains information specific to batteries manufactured at time of its publication. Please contact your Energizer representative for most current information. Contents herein do not constitute a warranty.