

Type	: Rechargeable Nickel Metal Hydride Cylindrical Cell
Nominal Dimension (with Sleeve)	: $\Phi = 10.5\text{mm}$ H = 44.5mm
Applications	: Recommended discharge current 80 to 2400mA
Nominal Voltage	: 1.2V
Capacity	: Nominal: 800mAh Minimum: 780mAh Typical: 800mAh When discharged at 160mA to 1.0V at 20°C
Charging Condition	: 80mA for 16 hrs at 20°C
Fast Charge	: 400mA to 800mA (0.5 to 1C) charge termination control recommended control parameters: - ΔV : 0-5mV **DT/dt : 0.8°C/min (0.5 to 0.9C) 0.8 - 1°C/min (1C) **TCO : 45 - 50°C **Timer : 105% nominal input ** for ref. only
Service Life	: >500 cycles (IEC standard)
Continuous Overcharge	: 80mA maximum current for 1 year. No conspicuous deformation and/or leakage
Weight	: 14.0g
Internal Resistance	: Average 40m Ω upon fully charged (Range 20 - 60m Ω) at 1000Hz
Max. Charging Voltage	: 1.5V at 80mA charging
Ambient Temperature Range	: Standard Charge : 0 to 45°C Fast Charging : 10 to 45°C Discharge : -20 to 50°C Storage : -20 to 35°C

Model No.: **GP80AAAHC**

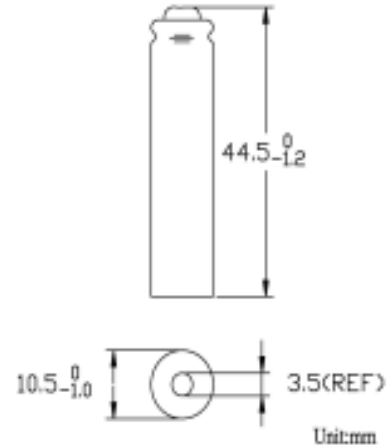

Low Rate Discharge

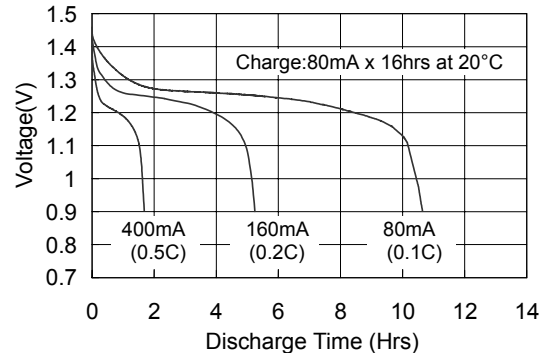

Fast Charge (Charge control required)

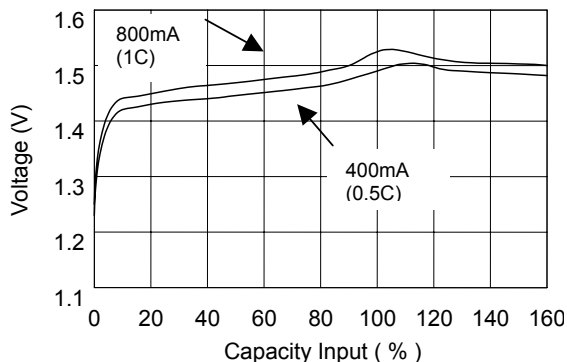

High Rate Discharge

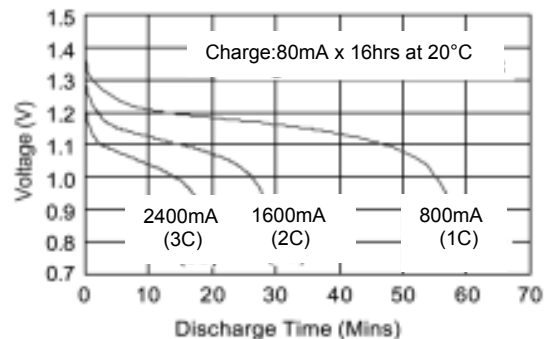

The information (subject to change without prior notice) contained in this document is for reference only and should not be used as a basis for product guarantee or warranty. For applications other than those described here, please consult your nearest GP Sales and Marketing Office or Distributors.