

## Sealed Nickel-Metal Hydride Rechargeable Batteries

Model:NH-3000SC

### Specifications

Nominal Voltage		1.2 Volt
Rated Capacity		3000 mA
Dimensions	Diameter in. (mm)	0.87 (22.1)
	Height in. (mm)	1.65 (42.0)
	Height with solder tabs	1.69 (43.0)
Weight Approx.	Weight Approx.	59 gm
	Internal Resistance	<11 mΩ
	Standard Charge (0.1C)	300 mA
	Trickle Charge	(0.03C)~(0.05C)
	Fast Charge	1500 mA
Recommended Operating Temperature Range	Std/Trickle Charge	20±5°C
	Fast Charge	20±5°C
	Discharge	20±5°C
	Storage	-20°C to 45°C
Standard Discharge (0.2C) Cut Off Voltage		1.0V per cell
High Rate Discharge (1 C) Cut Off Voltage		1.0V per cell

### Dimensions

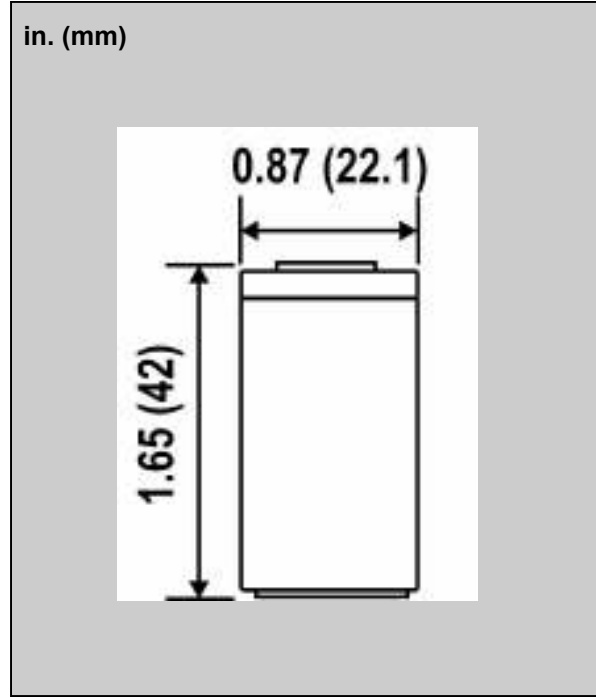

## Charging and Discharging Characteristics

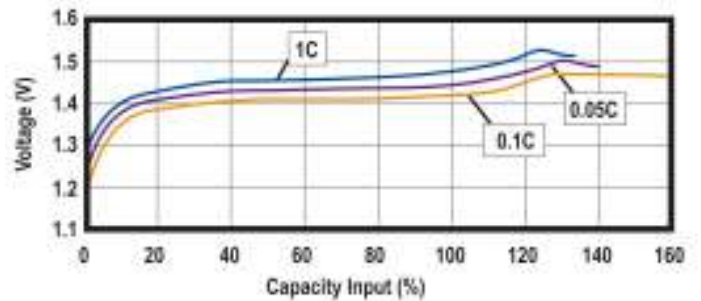
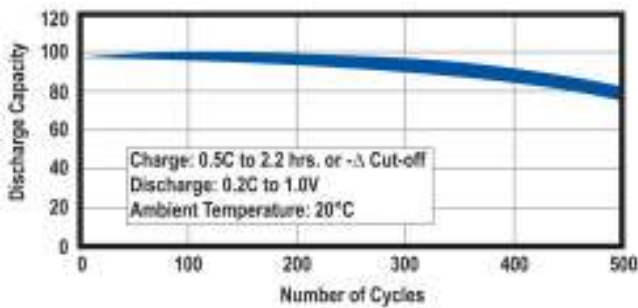

## Discharge Cycle Life      Standard Charge

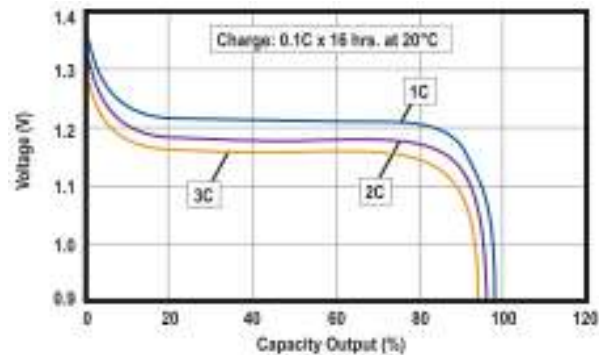
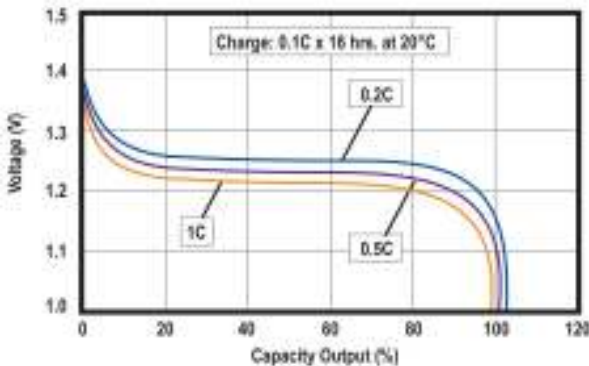

## Standard Battery Discharging (0.2C/0.5C/1C)      Standard Battery Discharging (1C/2C/3C)

Please note the following graphs are for High Temperature and High Power batteries. These batteries do not form part of our standard range, but both types are available on request subject to minimum order quantities and delivery times. Please contact us for further details.

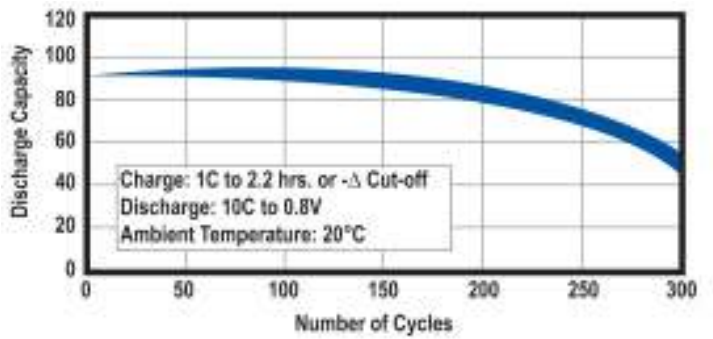
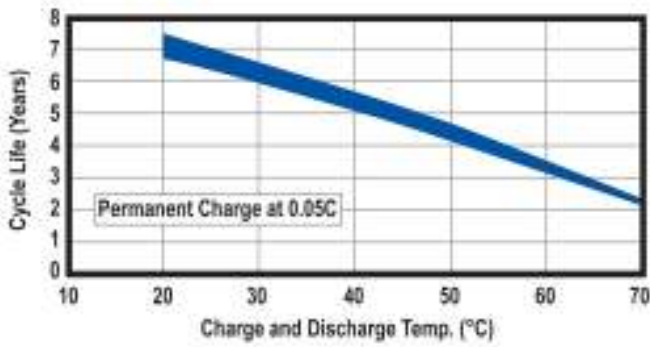

**High Temp. Battery Charging and Discharging**

**High Power (10C Discharge) Cycle Life**

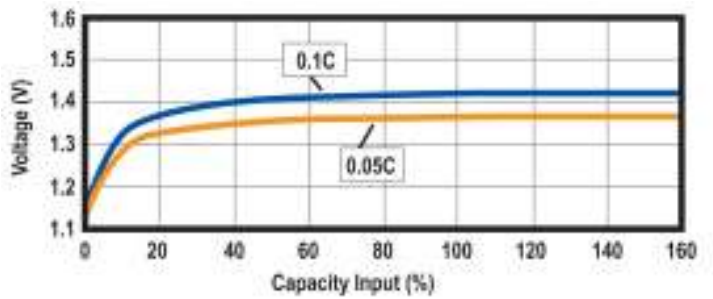
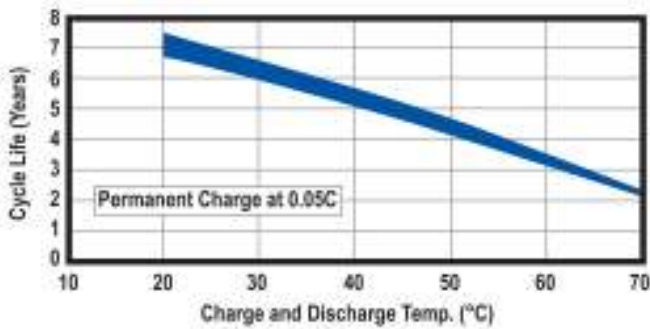

**High Temp. Battery Discharge Cycle Life**

**High Temp. Battery Trickle Charge**

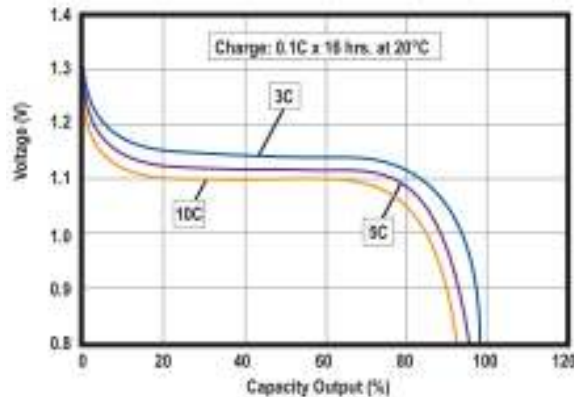

**High Power Battery Discharging (3C/5C/10C)**

**Corporate Headquarters and Domestic Sales**

Power-Sonic Corporation • 7550 Panasonic Way • San Diego, CA 92154 • U.S.A

Phone: (619) 661-2020 • Fax: (619) 661.3650

Email Sales: [national-sales@power-sonic.com](mailto:national-sales@power-sonic.com)

Email Customer Service: [customer-service@power-sonic.com](mailto:customer-service@power-sonic.com)

E-mail Technical Support: [technical-support@power-sonic.com](mailto:technical-support@power-sonic.com)

**International Sales**

Power-Sonic Corporation • P.O. Box 5242 • Redwood City, CA 94063 • U.S.A.

Phone: (650) 364-5001 • Fax: (650) 366-3662

Email Sales: [international-sales.com@power-sonic.com](mailto:international-sales.com@power-sonic.com)

**[www.power-sonic.com](http://www.power-sonic.com)**

© Copyright 2010 Power-Sonic Corporation. All rights reserved