

## Sealed Nickel Cadmium Batteries

Model: PS-F

### Specifications

Nominal Voltage		1.2 Volt
Rated Capacity		7000 mA
Dimensions	Diameter in. (mm)	1.27 (32.2)
	Height in. (mm)	3.50 (89.0)
	Height with solder tabs	3.54 (90)
	Weight Approx.	179 gm
	Internal Resistance	< 7 mΩ
	Standard Charge (0.1C)	700 mA
	Trickle Charge	(0.03C)~(0.05C)
	Fast Charge ΔV	2100 mA
Recommended Operating Temperature Range	Std/Trickle Charge	20±5°C
	Fast Charge	20±5°C
	Discharge	20±5°C
	Storage	-20°C to 45°C
Standard Discharge (0.2C) Cut Off Voltage		1.0V per cell
High Rate Discharge (1 C) Cut Off Voltage		1.0V per cell

### Dimensions

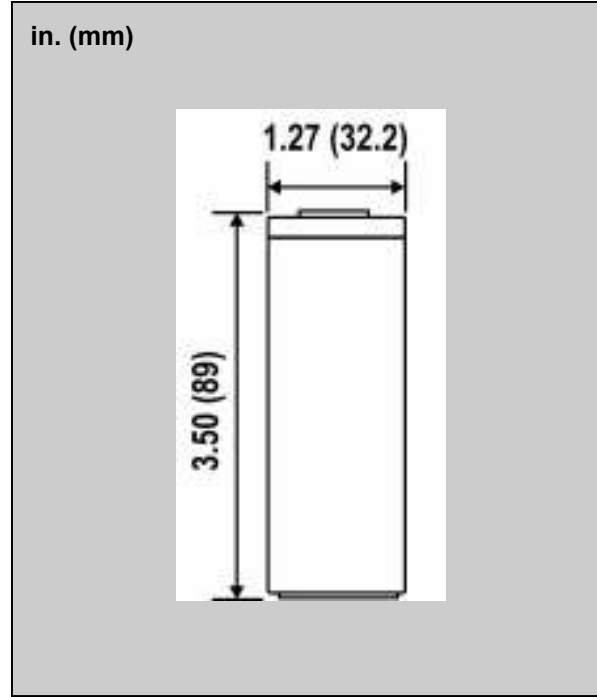

### Charging and Discharging Characteristics

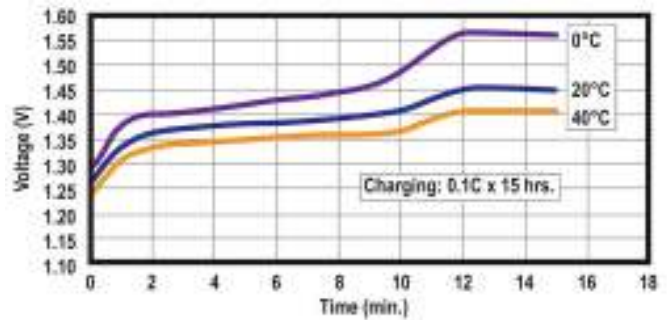
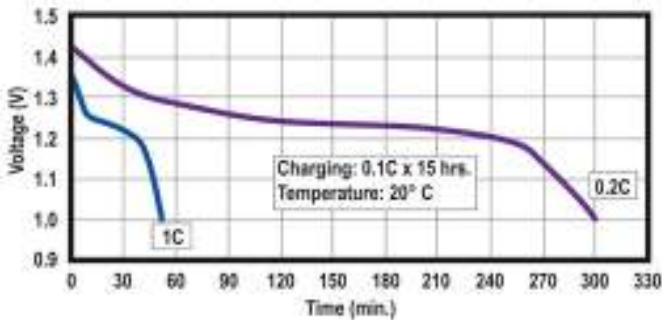

### Discharge

### Standard Charge

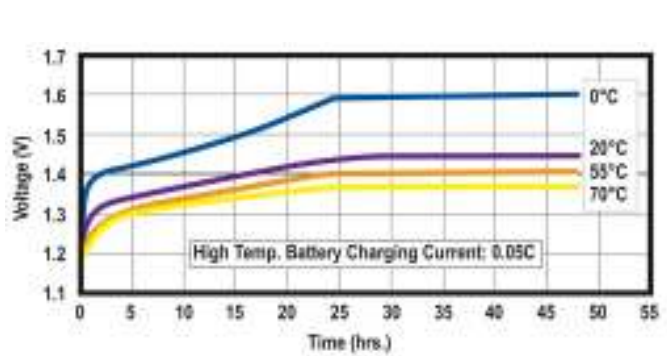
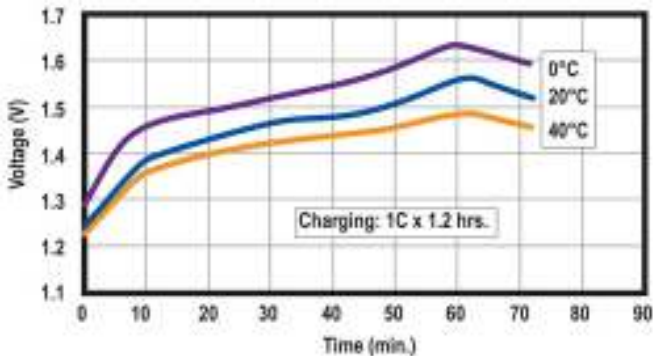

### Fast Charge

### Trickle Charge

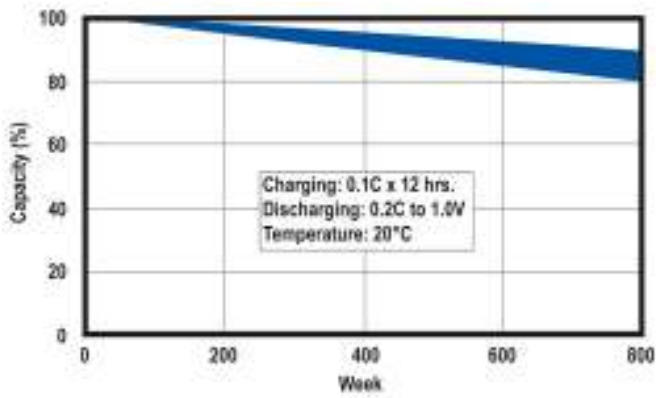

**Standard Battery Cycle Life**

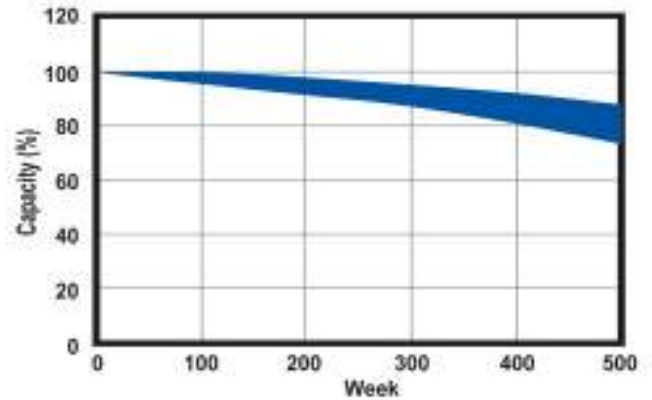

**Fast Charging Cycle Life**

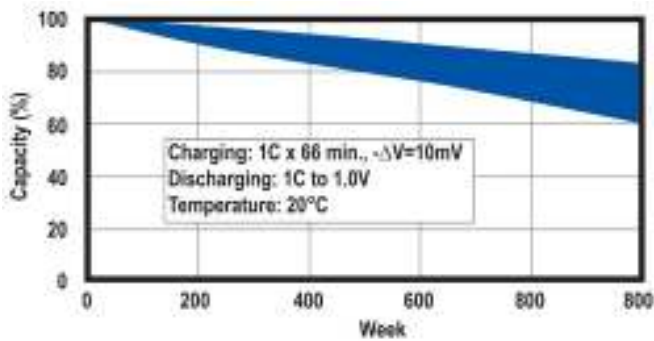

**Cycle Life Using Trickle Charging**

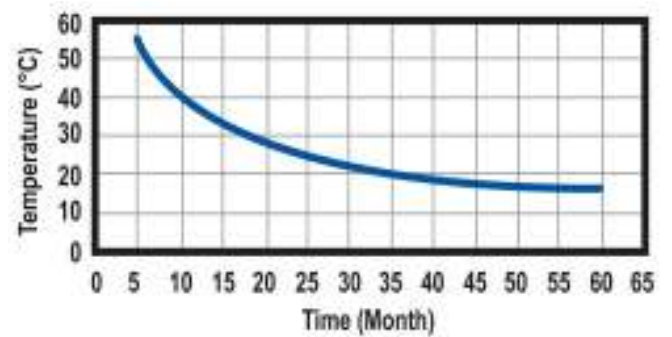

**Stand-by Battery Life**

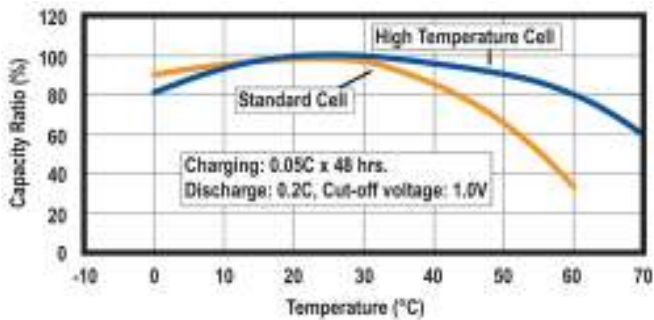

**Capacity vs. Temperature**

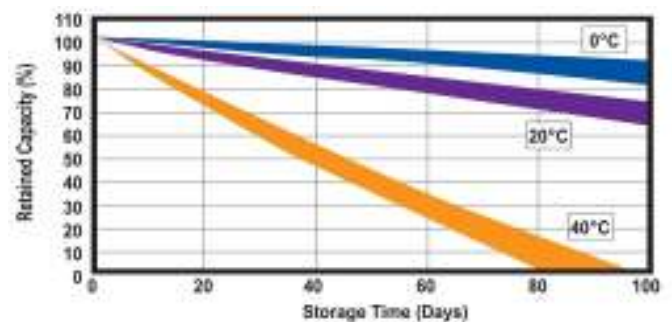

**Retained Capacity In Storage**

**Corporate Headquarters and Domestic Sales**

Power-Sonic Corporation • 7550 Panasonic Way • San Diego, CA 92154 • U.S.A

Phone: (619) 661-2020 • Fax: (619) 661.3650

Email Sales: [national-sales@power-sonic.com](mailto:national-sales@power-sonic.com)

Email Customer Service: [customer-service@power-sonic.com](mailto:customer-service@power-sonic.com)

E-mail Technical Support: [technical-support@power-sonic.com](mailto:technical-support@power-sonic.com)

**International Sales**

Power-Sonic Corporation • P.O. Box 5242 • Redwood City, CA 94063 • U.S.A.

Phone: (650) 364-5001 • Fax: (650) 366-3662

Email Sales: [international-sales.com@power-sonic.com](mailto:international-sales.com@power-sonic.com)

**[www.power-sonic.com](http://www.power-sonic.com)**

© Copyright 2010 Power-Sonic Corporation. All rights reserved