

## Sealed Nickel Cadmium Batteries

Model: PS-2/3A

### Specifications

|   |                         |                 |
|---|-------------------------|-----------------|
| Nominal Voltage                           |                         | 1.2 Volt        |
| Rated Capacity                            |                         | 600 mA          |
| Dimensions                                | Diameter in. (mm)       | 0.64 (16.3)     |
|   | Height in. (mm)         | 1.08 (27.4)     |
|   | Height with solder tabs | 1.12 (28.4)     |
| Weight Approx.                            | Weight Approx.          | 15.5 gm         |
|   | Internal Resistance     | < 30 mΩ         |
|   | Standard Charge (0.1C)  | 60 mA           |
|   | Trickle Charge          | (0.03C)~(0.05C) |
|   | Fast Charge ΔV          | 600 mA          |
| Recommended Operating Temperature Range   | Std/Trickle Charge      | 20±5°C          |
|   | Fast Charge             | 20±5°C          |
|   | Discharge               | 20±5°C          |
|   | Storage                 | -20°C to 45°C   |
| Standard Discharge (0.2C) Cut Off Voltage |                         | 1.0V per cell   |
| High Rate Discharge (1 C) Cut Off Voltage |                         | 1.0V per cell   |

### Dimensions

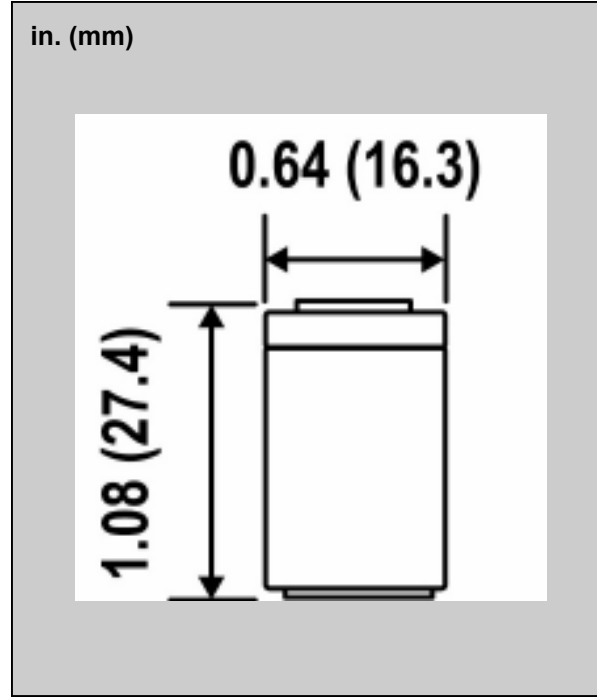

### Charging and Discharging Characteristics

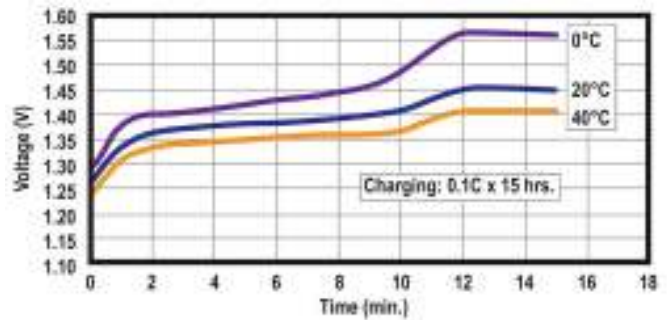
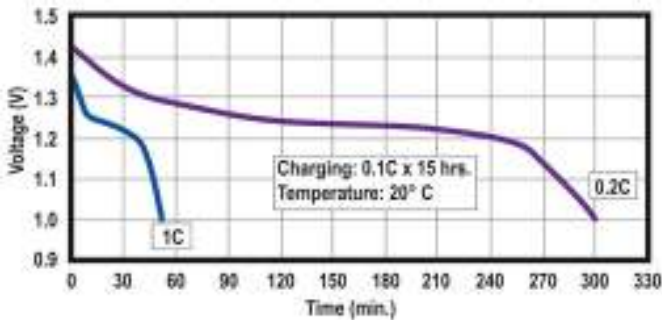

### Discharge

### Standard Charge

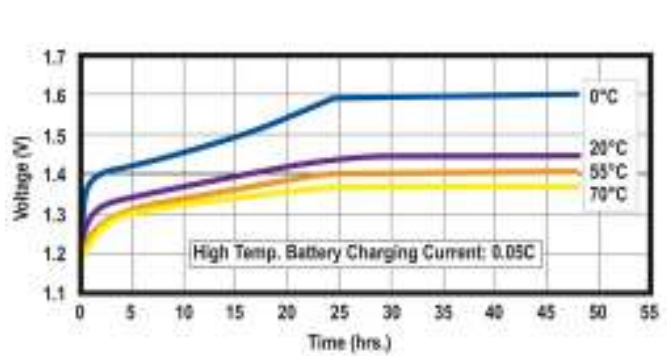
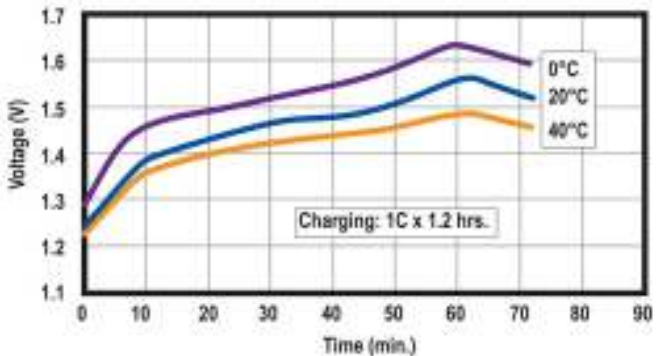

### Fast Charge

### Trickle Charge

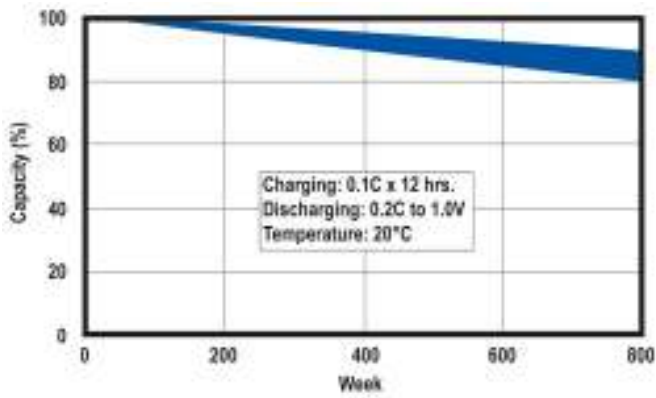

**Standard Battery Cycle Life**

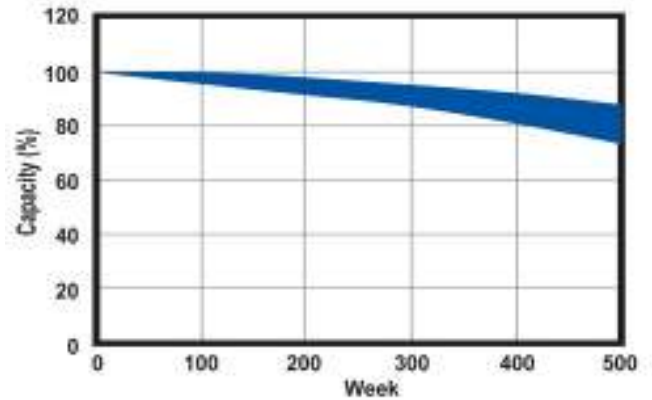

**Fast Charging Cycle Life**

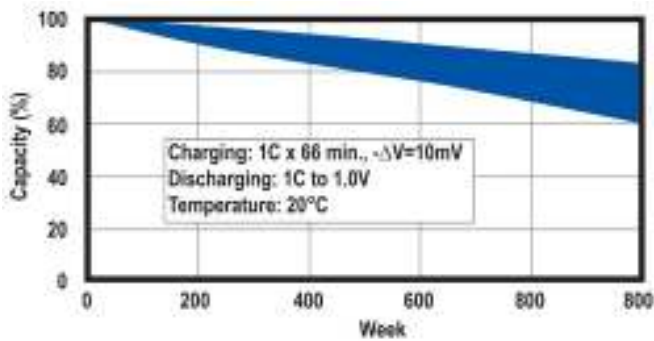

**Cycle Life Using Trickle Charging**

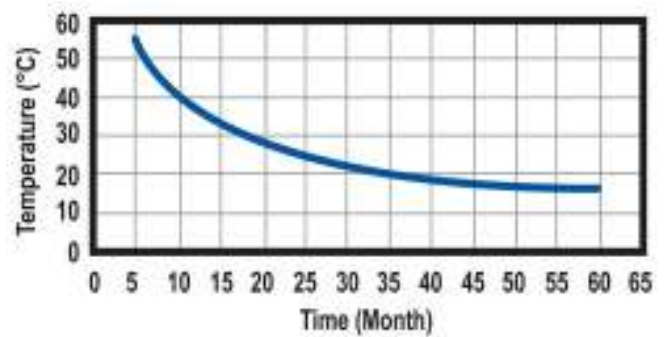

**Stand-by Battery Life**

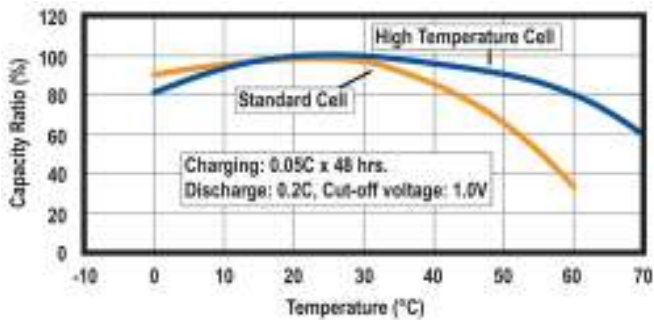

**Capacity vs. Temperature**

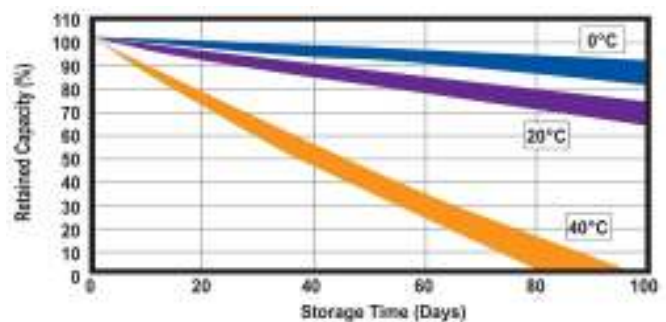

**Retained Capacity In Storage**

**Corporate Headquarters and Domestic Sales**

Power-Sonic Corporation • 7550 Panasonic Way • San Diego, CA 92154 • U.S.A

Phone: (619) 661-2020 • Fax: (619) 661.3650

Email Sales: [national-sales@power-sonic.com](mailto:national-sales@power-sonic.com)

Email Customer Service: [customer-service@power-sonic.com](mailto:customer-service@power-sonic.com)

E-mail Technical Support: [technical-support@power-sonic.com](mailto:technical-support@power-sonic.com)

**International Sales**

Power-Sonic Corporation • P.O. Box 5242 • Redwood City, CA 94063 • U.S.A.

Phone: (650) 364-5001 • Fax: (650) 366-3662

Email Sales: [international-sales.com@power-sonic.com](mailto:international-sales.com@power-sonic.com)

**[www.power-sonic.com](http://www.power-sonic.com)**

© Copyright 2010 Power-Sonic Corporation. All rights reserved