

LITHIUM - Coin Type

Coin type lithium batteries are high energy, high reliability batteries for a variety of applications. The full 3 volts in these high energy density batteries is about twice that of conventional dry batteries.

Panasonic coin type lithium batteries are available in two types: poly-carbonmonofluoride lithium batteries (BR series) for uses that require extended reliability and safety, and manganese dioxide lithium batteries (CR series) for uses that require high voltage and strong load pulse characteristics.



The CR Lithium primary coin cells contain Perchlorate over the limit specified by the state legislature of California and are therefore subject to requirements in the California Code of Regulations, title 22, division 4.5: Chapter 33 – Best Management Practices for Perchlorate Materials.

Features:

- High voltage of 3 volts - twice that of conventional dry batteries
- Extremely small self-discharge for long service and shelf life
- A wide operational temperature range
- Compact and lightweight; extremely high energy density per unit weight
- Very safe (poly-carbonmonofluoride lithium)
- Extremely strong load pulse characteristics (manganese dioxide lithium)
- Operating temperature range:
 - BR Coin Cells: -30°C ~ +80°C
 - CR Coin Cells: -30°C ~ +60°C

Applications:

- Calculators
- Cameras
- Compact, low power consuming cordless applications
- Electronic translators
- Electronic watches (digital and analog)
- Memory back-up in all types of devices (with tab terminals)

Technical Data - Table 1 - (CF)n/LI: Poly-Carbon Monofluoride (BR)

Model No.	Electrical Characteristics (20°C)		Standard Load	Dimensions			Tab Configurations
	Nominal Voltage (V)	*Nominal Capacity (mAh)	Continuous Drain (mA)	Diameter (mm)	Height (mm)	Weight (g)	
BR1220	3	35	0.03	12.5	2.00	0.7	
BR1225	3	48	0.03	12.5	2.50	0.8	
BR1632	3	120	0.03	16.0	3.20	1.5	
BR2032	3	190	0.03	20.0	3.20	2.5	
BR2325	3	165	0.03	23.0	2.50	3.2	
BR2330	3	255	0.03	23.0	3.00	3.2	
BR3032	3	500	0.03	30.0	3.20	5.5	

* Nominal capacity shown is based on standard drain and cut off voltage down to 2.0V at 20°C.

Technical Data - Table 2 - MnO₂/LI:Manganese Dioxide (CR)

Model No.	Electrical Characteristics (20°C)		Standard Load	Dimensions			Tab Configurations
	Nominal Voltage (V)	*Nominal Capacity (mAh)	Continuous Drain (mA)	Diameter (mm)	Height (mm)	Weight (g)	
CR1025	3	30	0.10	10.0	2.50	0.7	
CR1216	3	25	0.10	12.5	1.60	0.7	

Poly-carbonmonofluoride Lithium Coin Batteries: Individual Specifications

BR2325

■ Dimensions(mm)

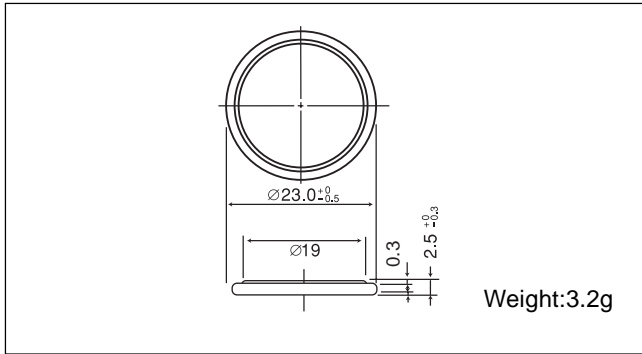

■ Specification

Nominal voltage (V)	3
Nominal capacity (mAh)	165
Continuous standard load (mA)	0.03
Operating temperature (C)	-30 ~ +80

■ Temperature Characteristics

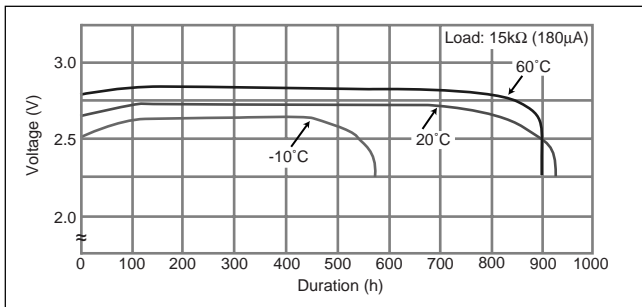

■ Operating voltage vs. load resistance (voltage at 50% discharge depth)

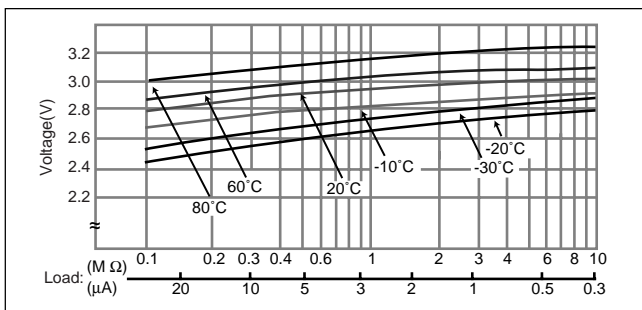

■ Capacity vs. load resistance

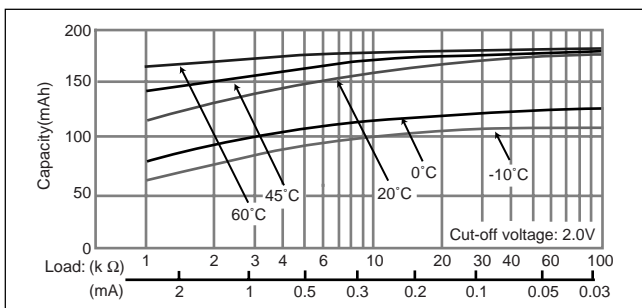

BR2330

■ Dimensions(mm)

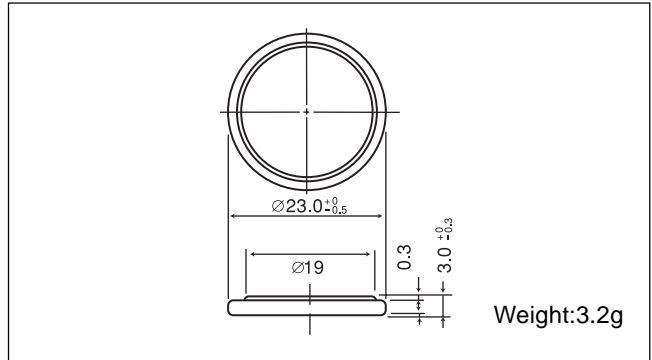

■ Specification

Nominal voltage (V)	3
Nominal capacity (mAh)	255
Continuous standard load (mA)	0.03
Operating temperature (C)	-30 ~ +80

■ Temperature Characteristics

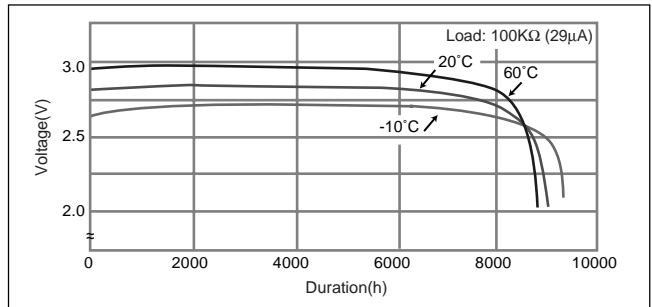

■ Operating voltage vs. load resistance (voltage at 50% discharge depth)

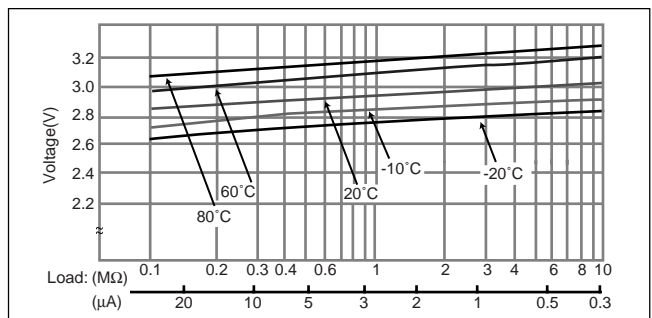

■ Capacity vs. load resistance

