

SPECIFICATIONS

"Preliminary"



Model Number: DDE893524Z1E
Part Number: 041000

April 11, 2007

Mechanical Drawing:

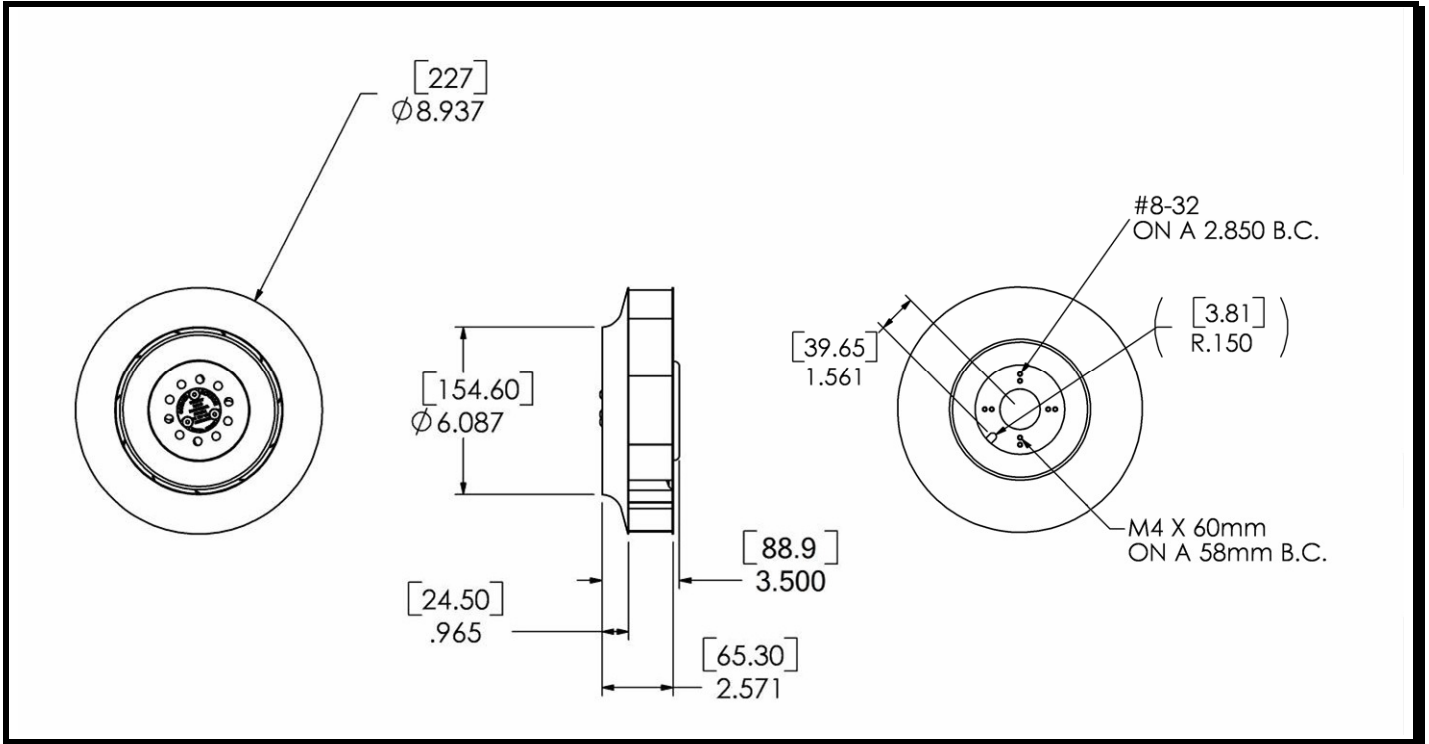

Motor:

Nominal Voltage	= 24 VDC
Operating Voltage Range	= 16 - 32 VDC
Nominal Running Current	= 5.2 amps
Locked Rotor Current	= TBD amps
Running Power	= 142 watts
Average Speed	= 3530 RPM
Bearings	= Ball
Air Flow	= 750 CFM
Static Pressure	= 3.4 (in/H ₂ O)
Acoustic	= TBD

Construction:

Motor Base: Die Cast Aluminum
Propeller: Sheet Metal, Galvanized

Agency Approvals:

Pending

Life Expectancy:

TBD

Additional Features:

Brushless DC Motor
Electronic Locked Rotor Protection
Polarity Protected
Automatic Restart Capability
Operating Temperature: -10°C to 70°C
Storage Temperature: -40°C to 85°C

Tachometer Specifications:

Output:	Open Collector
Ic:	20 mA. Max
Vcc:	32 VDC Max
Pulses per Revolution:	2
Isolated:	No

Termination:

12" Leadwires, 22 AWG, UL 1061
Red - Power (+)
Black - Return (-)
Blue/White - Tachometer (Output)