





SPECIFICATION FOR APPROVAL

TO : _____

REF. No. _____

APPROVED DATE 	CHECKED DATE  	PREPARED DATE 
---	--	---

MODEL No. AB4505MB-GD3 P.S. (B)

DESCRIPTION: DC FAN REV. B

ID No. _____

THIS OFFER IS MADE ACCORDING TO YOUR CURRENT INQUIRY.
UNLESS OTHERWISE REVISED, THIS SPECIFICATION WILL BE FINAL FOR
ALL FUTURE PRODUCTION OF ORDERS FROM YOUR RESPECTED COMPANY

KINDLY STUDY IN DETAILS AND RETURN TO US THE DUPLICATE DULLY
SIGNED AS YOUR CONFIRMATION OF SAME.



ADDA CORPORATION



ISO 9001:1994
QS-9000:1998
Certificate No. A8035

BRUSHLESS AXIAL COOLING FANS

Customer :	Ref:	
Adda Model No. :	AB4505MB-GD3	P.S:(B)
Samples attached :	piece(s),	
Safety Approval :	UL, CUL, TUV, CE	
Specifications		
=====		
ITEM	SPECIFICATION / CONDITION	
DIMENSIONS	:	45x45x10 MM
BEARING TYPE	:	BALL
RATED VOLTAGE	:	5.0 VDC
OPERATING VOLTAGE RANGE	:	4.5 VDC - 5.5 VDC
START-UP VOLTAGE	:	4.0 VDC, NOMINAL
RATED CURRENT	:	0.150 Amp. + 10% MAX
RATED POWER	:	0.75 Watt.
RATED SPEED	:	5000 RPM \pm 10%
AIR FLOW	:	2.3 CFM
STATIC AIR PRESSURE	:	0.342 Inch Water
NOISE LEVEL	:	31.1 dB
MOTOR PROTECTION	:	BY IC (FG)
CONNECTION LEAD TYPE	:	WIRE, AWG#30
LIFE EXPECTANCY	:	50000 Hours at 25°C
NET WEIGHT	:	25 Gram.
PACKING	:	720 pcs. per Export Carton.
ADDA CORPORATION	Model No.:AB4505MB-GD3	P.S:(B)
		Page 1/4



SPECIFICATION

1.0 SCOPE

This documentation defines the mechanical & electrical Characteristics of DC Brushless Fans.

2.0 MATERIAL

- 2.1 Housing : Aluminum alloy
- 2.2 Fan Blade : UL94V-0 Glass Filled polyester (P.B.T)
- 2.3 Bearing Sys. : Sleeve, oil impregnated.
 Two Ball Bearing
 One Ball one Sleeve
 Hypro Bearing

3.0 DIMENSIONS & CONSTRUCTION

All dimensions, Direction of rotation and air flow were specified as per drawing attached.

4.0 CHARACTERISTICS & DEFINITION

- 4.1 All rated characteristics were specified as per data sheet enclosed.
- 4.2 Rated Current : Rated Current shall be measured after 3 minutes of continuous rotation at rated voltage.
- 4.3 Rated Speed : Rated Speed shall be measured after 3 minutes of continuous rotation at rated voltage.
- 4.4 Start Voltage : The voltage which is able to start the fan to operate by suddenly switching 'ON'.
- 4.5 Input Power : Input Power shall be measured after 3 minutes of continuous rotation at rated voltage.
- 4.6 Locked Rotor Current : Locked current shall be measured within one minute of rotor locked, after 3 minutes of continuous rotation at rated voltage in clean air.
- 4.7 Air Flow & Static Pressure : The air flow data and static pressures should be determined in accordance with AMCA standard or DIN24163 specification in a doublechamber testing with intake-side measurement.
- 4.8 Noise Level : The measurement of noise level is carried out with reference to CNS8753 in an echoic chamber with the microphone positioned 1 meter from the air intake. Testing fan shall be hung in clean air.

NOISE LEVEL MEASUREMENT

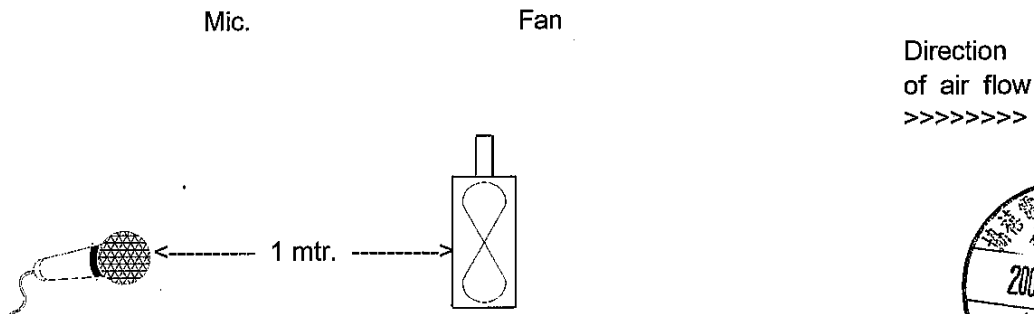

SPECIFICATION

5.0 MECHANICAL INSPECTION

5.1 Rotation Direction

Clockwise with label side facing up. The same direction also indicated by an arrow mark on one side of the housing.

5.2 Protection

All fans have integrated protection against locked rotor condition so that there will be no damage to winding or any electronic component.

Restarting is automatic as soon as any constraint to rotation has been released.

As fan placed at dead angle position, and the switch was changed from off to on. Restarting was automatic normal as soon as and proved that this fan is good fan.

5.3 Locked Rotor Protection

No damage shall be found after 72 hours continuously at condition of rotation locked.

Restarting is automatic as soon as constraint to running has been released.

5.4 Avoid the damage, check the correct voltage and proper polarity before connecting with power.

5.5 Free Drop Shock

In minimum package condition, the fan should withstand drops on any three faces from a height of 30cm onto a wood board of 10mm thick.

6.0 ELECTRICAL INSPECTION

6.1 Insulation Resistance

Not less than 10M ohm between housing and positive end of lead wire (red) at 500V DC.

6.2 Dielectric Strength

No damage should be found at 1,500 VAC for 60 seconds, measured with 5mA trip current between housing and positive end of lead wire.

6.3 Life Expectancy

The continuous duty life at given temperature after which, 90% of testing units shall still be running.

7.0 ENVIRONMENTAL

7.1 Operating Temperature / Humidity

-10°C to +70 at humidity 65%±20% RH.

7.2 Storage Temperature

All function shall be normal after 500 hours storage at -40°C to +70 °C with a 24 hour recovery period at room temperature.

7.3 Humidity

After 96 hours, 95% RH, 40±2°C per MIL-STD-202F, method 103B humidity test, the measured data on insulation resistance and dielectric strength shall meet the specification.



SPECIFICATION

8.0 REMARKS

- 8.1 Material and construction are subject to change without advance notice. The changes should be within specification.
- 8.2 All fans shall meet the quality inspection under sampling plan MIL-STD-105D as follow:

Critical	0.25%
Major	1.00%
Minor	2.50%

9.0 OUTLINE STYLING & DIMENSIONS

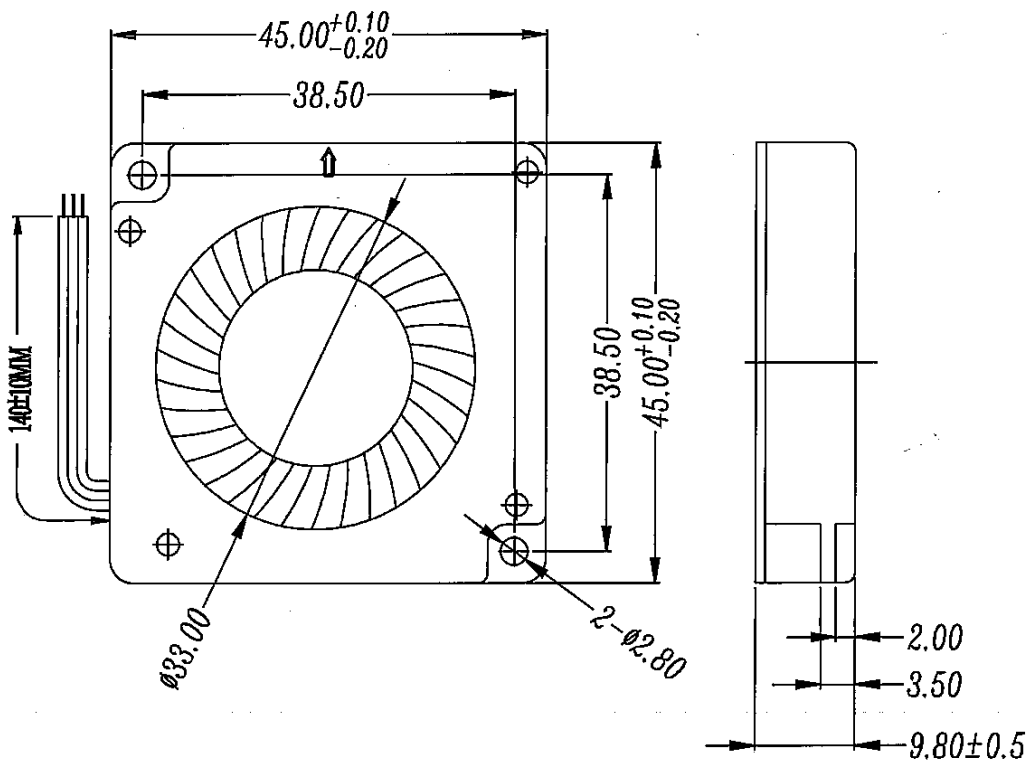

please do not touch and push Fan Blade with fingers or others.
Fan Blade and Ball Bearings may be damaged.
And it causes noise defect.

LEAD WIRES : UL 1571, AWG28 , L = 140 +/- 10 MM
Red = positive ; Black = negative.



PROVISION OF LOCKED SIGNAL (F.G)

- OUTPUT OF LOCKED SIGNAL
- ELECTRICAL SPECIFICATION

BUILT-IN RESISTOR TYPE

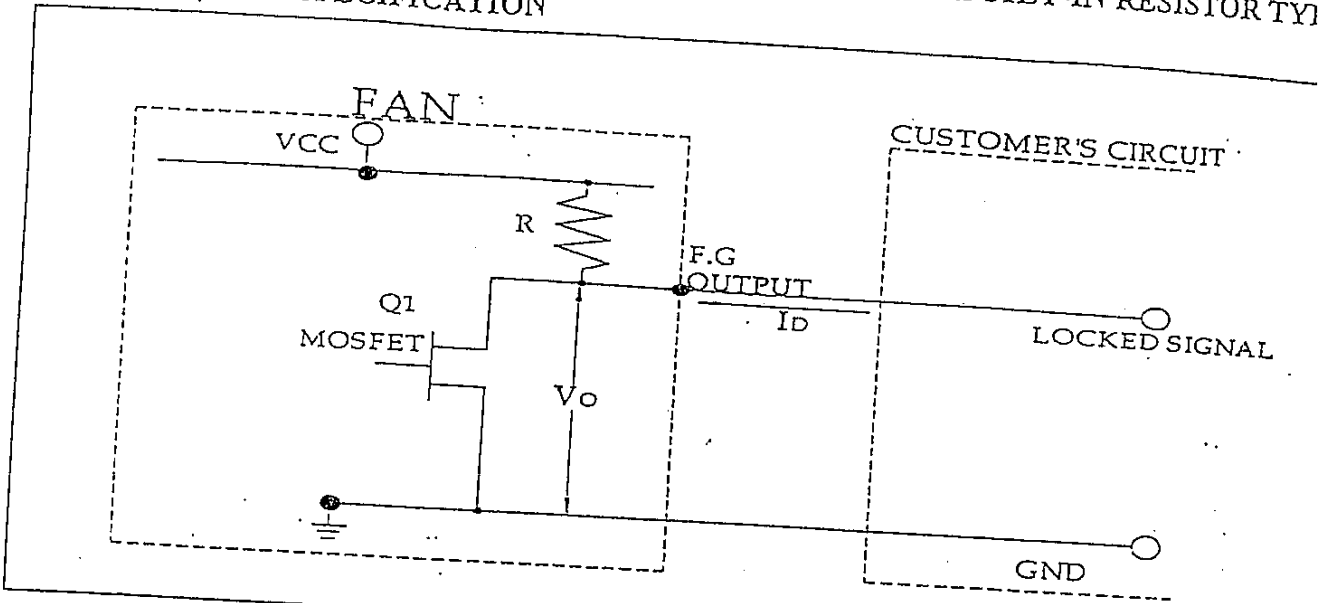

*MOSFET Q1 AT "ON" POSITION

DRAIN CURRENT -----

$I_D = 10\text{mA}$ MAX

SATURATION VOLTAGE -----

$V_{OL} = 0.5\text{V}$ MAX

*MOSFET Q1 AT "OFF" POSITION

RELEASE VOLTAGE -----

$V_{OH} = 6\text{V}$ MAX

*FAN SUPPLY VOLTAGE -----

$V_{CC} = 6\text{V}$ MAX

• OUTPUT WAVEFORM

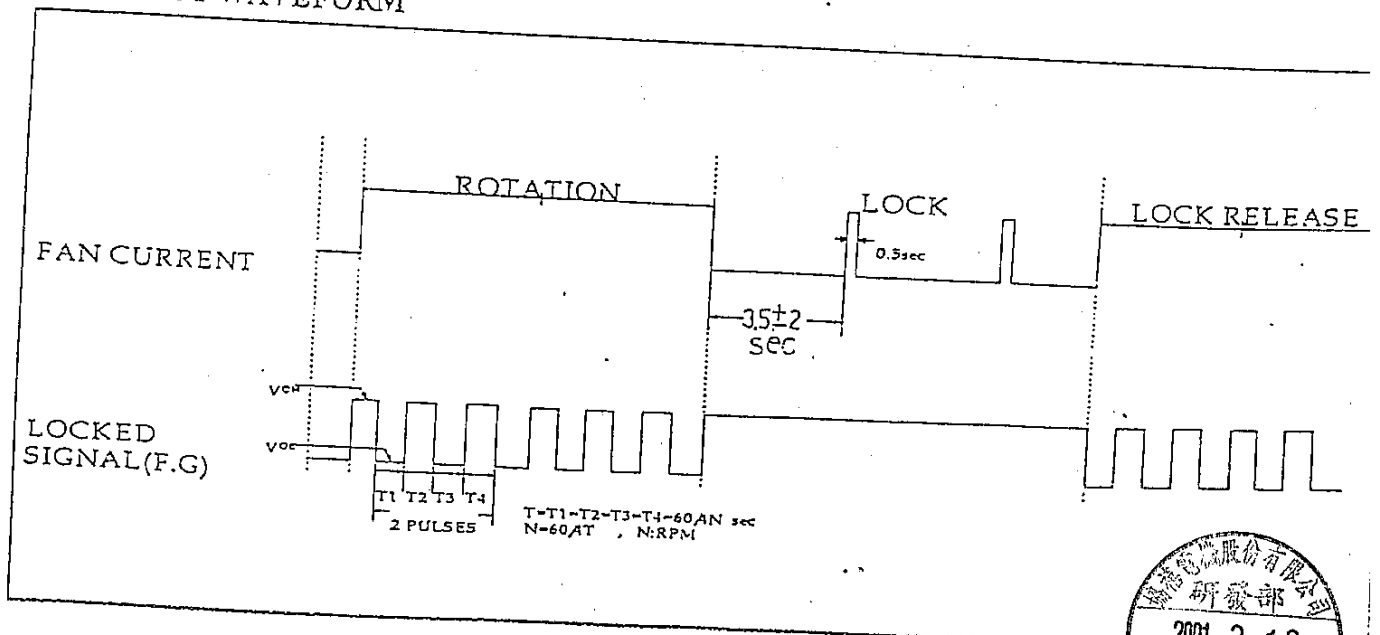

Northbrook, Illinois • (847) 272-8800
Melville, New York • (631) 271-6200
Santa Clara, California • (408) 995-2400
Research Triangle Park,
North Carolina • (919) 549-1400
Camas, Washington • (360) 617-5500

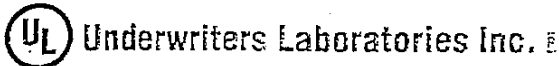

ADDA CORP
MR R SHIEH
NO 6 E SECTION INDUSTRY 6 RD
PING TUNG TAIWAN

RE: Project Number(s) - 01NK02166

Your most recent listing is shown below. Please review this information and report any inaccuracies to the UL Engineering staff member who handled your project.

For information on placing an order for UL Listing Cards in a 3 x 5 inch format, please refer to the enclosed ordering information.

GPWV8 February 27, 2001
Fans, Electric Certified For Canada - Component

ADDA CORP
NO 6 E SECTION INDUSTRY 6 RD, PING TUNG TAIWAN

E132139

Models AD08(A)(D)(C)-C70, AD09(A)(B)(C)-C70, where (A) may be 12 or 24, (B) may be H or M, (C) may be B or S, (D) may be H, L or M.
Models AD0205(A)(B)-(C)(D), AD0212(A)(B)-(C)(D), AD0305(A)(B)-(C)(D), AD0312(A)(B)-(C)(D), AD2005(A)(B)-(C)(D), AD2012(A)(B)-(C)(D)
where (A) may be D, H, L or M, (B) may be B, S or X, (C) may be G, (D) may be 50 or 70.
Model AD2512HB-BV7.
Models AD04(A)(B)(C)-G70, AD0403L(C)-G70, AD0405(D)(C)-K96, AD0424(B)(C)-C70, where (A) may be 05 or 12, (B) may be H or M, (C)
may be B, S or X, (D) may be H, L or M; Model BD0412MS-G70.
Model AD04(A), (B), (C), (D) or (E), where (A) may be 05, 12 or 24, (B) may be H, L or M, (C) may be B, S or X, (D) may be C or K, (E)
may be 50, 51, 52, 53, 56 or C3.
Models AA128(A)(B)(C)-(D), AA838(A)(E)(C)-(F), where (A) may be 1 or 2, (B) may be D, H, L or M, (C) may be B, S or X, (D) may be AT,
AW, PT or PW, (E) may be H or M, (F) may be AT or AW.
Model AD0612UB-D72GL.
Models AA1281U(A)-(B), AA1282U(A)-(B), where (A) may be B, S or X, (B) may be AT or AW.
Models AD09(A)(B)(C)-A70GL, AD12(A)(B)(C)-A71GL, AD12(A)(B)(C)-A72GL, where (A) may be 12 or 24, (B) may be H, L or M, (C) may
be B, S or X.
Models AD0912(A)(Y)-A(W)GL, AD0912(A)(Y)-A2GL, where (A) may be H, L, M or U, (Y) may be B, S or X, (W) may be 71, 72 or 73.
Models AD05(A)(B)(C)-(D), AD0505(E)(C)-G76, AD0512(E)(C)-(F), AD0512M(C)-D76, where (A) may be 05 or 12, (B) may be H or M, (C)
may be B, S or X, (D) may be D70, D71 or G90, (E) may be H, L or M, (F) may be G70 or G76.
Models AD08(A)(B)(C)-D71, AD08(D)UB-A(E)GL, AD0812(B)B-D74 where (A) may be 05 or 12, (B) may be H or M, (C) may be B, S or X,
(D) may be 12 or 24, (E) may be 71, 72 or 73.
Models AD06(A)(B)(C)-(E), AD06(A)(D)(C)-G90, AD0612(D)(C)-G96, where (A) may be 05 or 12, (B) may be H or M, (C) may be B, S or X,
(D) may be H, L or M, (E) may be D71GL, D72GL or D73GL.
Models AD0305(D)(B)-G56, AD0312L(B)-G50, AD0405(A)(B)-C50, AD0412(B)(C)-C50, where (A) may be L or M, (B) may be B, S or X, (C)
may be H, L or M, (D) may be D or L.
Model Atu05vw-xyz, where t may be B or D, u may be 03, 04, 05 or 45, v may be H, L or M, w may be B, S or X, x may be G or R, y may
be 7, B or D, z may be 1, 3 or B.
Model AD2512(A), where (A) may be MB, MS or MX.
Model AD0812H(C)-A74GL, where (C) may be B, S or X.
Models AD12(A)(B)(F)-A72G2, AD12(A)(B)(F)-A71GL, where (A) may be 12 or 24, (B) may be H, L or M, (F) may be B, S or X.
Model AD12(X1)(X2)(X3)-F(X4), where (X1) may be 12, 24 or 48, (X2) may be H, L, M or U, (X3) may be B, S or X, (X4) may be 51, 52 or 53.
Model AD09(A)(B)(F)-(C), (A) may be 12 or 24, (B) may be H, L or M, (F) may be B, S or X, (G) may be AD0GL or AD2GL.
Model AD02(A)L(B)-G70, where (A) may be 05 or 12, (B) may be B, S or X; Model AD0205L(C)-G50, where (C) may be B or X.
Model AD75(A)(B)(C), where (A) may be 12 or 24, (B) may be H or M, (C) may be B, S or X.
Models AD09(A)H(C)-A74GL, AD0912(B)(C)-A76GL, where (A) may be 12 or 24, (B) may be H, L or M, (C) may be B, S or X.
Model AD0924XY-A7ZGL.
Models AD4505H(B)-G70, AD4512(A)(B)-(C), where (A) may be H or M, (B) may be B, S or X, (C) may be G70 or G76.
Model AD1224(A)(B)-A74GL, where (A) may be H, L or M, (B) may be B, S or X.
Models AD0305L(X)-K70, AD0312L(X)-K70 where (X) may be B or X; Model AD0424MB-G70.
Models AD0612M(B)-D70GL, where (B) may be B, X or S; Model AD0812MB-D76.

349050002

Page 1 of 2

A non-for-profit organization
dedicated to public safety and
committed to quality service



Underwriters Laboratories Inc. 1

Models AD0612H(Y)-A76GL, AD0612M(Y)-A76GL, AD0612L(Y)-A76GL, where (Y) may be B, S or X.
 Models AD0305L(X)-K70, AD0312L(X)-K70 where (X) may be B or X; Model AD0424MB-G70.
 Models AD0412H(Y)-D50, AD0412H(Y)-D56, AD0412L(Y)-D50, AD0412L(Y)-D56, AD0412M(Y)-D50, AD0412M(Y)-D56 where (Y) may be B, S or X.
 Model AD0612M(B)-D70GL where (B) may be B, S or X; Model AD0812MB-D76.
 Models AD0612H(Y)-A76GL, AD0612L(Y)-A76GL, AD0612M(Y)-A76GL where (Y) may be B, S or X.
 Models AD0612D(Y)-D70GL, AD0612D(Y)-D76GL, AD0612H(Y)-D70GL, AD0612H(Y)-D76GL, AD0612L(Y)-D70GL, AD0612L(Y)-D76GL, AD0612M(Y)-D70GL, AD0612M(Y)-D76GL, where (Y) may be B, S or X.
 Model AD0624UX-A79GL.
 Models AD0612XY-C72GL, AD0612XY-C73GL, AD0612XY-C76GL, AD0624XY-C70GL, AD0624XY-C76GL Series where X may be H, L or M, Y may be B, S or X.
 Model AP45(A)(B)(C)-J(D), where (A) may be 05 or 12, (B) may be H, M or L, (C) may be B or X, (D) may be J or G, (E) may be 90 or 96.
 Models AD(P1)(P2)(P3)(P4)-G(P5), where (P1) may be 04, 05, or 45, (P2) may be 05, 12, or 24, (P3) may be L, M, H, or U, (P4) may be B, X, or S, and (P5) may be 70 or 76.
 Models AD02(A)(B)(C)-(D)(E), AD03(A)(B)(C)-(D)(E) and AD35(A)(B)(C)-(D)(E), where (A) may be 05 or 12; (B) may be L, M and D; (C) may be B or X; (D) may be G or D; (E) may be 50 or 53.
 Model AD(A)(B)(C)(D)-(E)(F), (A) may be 02, 04, 05, 08, (B) may be 05, 12 or 24, (C) may be H, M or L, (D) may be S, X or B, (E) may be D or G or K, (F) may be 53, 70, 71, 72, 76.
 Model ADabcd - efgh, where (a) may be 04, 06, 08 or 09, (b) may be 05, 12 or 48, (c) may be U, H, M or L, (d) may be B, S or X, (e) may be A, D, G, J or K, (f) may be 7, 9, A or C, (g) may be 0, 1, 3 or 6, and (h) may be GL or blank.
 Model AD(A)48H(B)-(C)(D)8(E), where (A) may be 08, 09 or 12, (B) may be B, S or X, (C) may be A or F, (D) may be 5 or 7, (E) may be GL or blank.
 Model AD(A)24(B)(C)-A7(D)GL, where (A) may be 09 or 12, (B) may be H or M, (C) may be B, S or X, and (D) may be 4 or A.
 Model AD0505(A)(B)-G70, where (A) may be H, M or L, and (B) may be B, S or X.
 Models AD0524HB-G70, AD0524HS-G70, AD0524HX-G70, AD0524MB-G70, AD0524MS-G70, AD0524MX-G70, AD0524LB-G70, AD0524LS-G70, AD0524LX-G70, AD0524HB-G76, AD0524HS-G76, AD0524HX-G76, AD0524MB-G76, AD0524MS-G76, AD0524MX-G76, AD0524LB-G76, AD0524LS-G76, AD0524LX-G76, AD0612UB-A71GL, AD0612US-A71GL, AD0612UX-A71GL, AD0612UB-A72GL, AD0612US-A72GL, AD0612UX-A72GL, AD0612UB-A73GL, AD0612US-A73GL, AD0612UX-A73GL.

Marking: Company name, model designation and the Recognized Component Mark for Canada, 

See General Information Preceding These Recognitions

For use only in equipment where the acceptability of the combination is determined by Underwriters Laboratories Inc.



Northbrook, Illinois • (847) 272-
Melville, New York • (516) 271-
Santa Clara, California • (408) 98
Research Triangle Park,
North Carolina • (919) 549-1400
Camas, Washington • (360) 817-

 Underwriters Laboratories Inc.®

ADDA CORP
MR R SHIEH
NO 6 E SECTION INDUSTRY 6 RD
PING TUNG TAIWAN

RE: Project Number(s) - 99NK17117

Your most recent listing is shown below. Please review this information and report any inaccuracies to the UL Engineering staff member who handled your project.

For information on placing an order for UL Listing Cards in a 3 x 5 inch format, please refer to the enclosed ordering information.

GPWV2
Fans, Electric - Component

October 6, 1999

ADDA CORP
NO 6 E SECTION INDUSTRY 6 RD, PING TUNG TAIWAN

E132139

Models AD0412HB-C70, -C71, AD0412HS-C70, -C71, AD0412MB-C70, -C71, AD0412MS-C70, -C71, AD0412LB-C70, -C71, AD0412LS-C70, -C71, AD06(A)(B)(C)-(F), AD0605M(C)-A70GL, AD0612(B)(C)-(E), AD08(A)(B)(C)-(D), AD08(A)(B)(C)-(G), AD0812H(C)-A74GL where (A) may be 12 or 24, (B) may be H, L or M, (C) may be B, S or X, (D) may be A70GL, A71GL, A76GL, (E) may be C70GL, C71GL, (F) may be A70GL, A71GL, A72GL or A73GL, (G) may be A72GL, A73GL.

Models AD08(A)(B)(C)-(A)(D), AD08(A)(B)(X)-(A)(E), AD09(A)(B)(C)-(A)(D), AD09(A)(B)(F)-(G), AD12(A)(B)(C)-(A)(E), AD12(A)(B)(F)-(A71GL, -A72GL where (A) may be 12 or 24, (B) may be H, L or M, (C) may be B or S, (D) may be 50, 51, 70, 71 or 72, (E) may be 70 or 71, (F) may be B, S or X, (G) may be A70GL or A72GL.

Models AD0205(A)(B)-(C)(D), AD0212(A)(B)-(C)(D), AD0305(A)(B)-(C)(D), AD0312(A)(B)-(C)(D), AD2005(A)(B)-(C)(D), AD2012(A)(B)-(C)(D) where (A) may be D, H, L or M, (B) may be B, S or X, (C) may be G, (D) may be 50 or 70.

Model AD2512HB-BV7.

Models AD0305(D)(B)-G56, AD0312L(B)-G50, AD0405(A)(B)-C50, AD0412(B)(C)-C50, where (A) may be L or M, (B) may be B, S or X, (C) may be H, L or M, (D) may be D or L.

Models AD0405LX-K90, AD0405MX-K90, AD0412MX-K90, AD0512LX-G70, AD0512MX-G70, AD0612HY-D74GL, where (Y) may be B, S or X, (X) may be B or X.

Model AD0(A)(BC)(D)(E)-C7(F) where (A) may be 8 or 9, (BC) may be 12 or 24, (D) may be H or M, (E) may be B, S or X, (F) may be 0 or 1.

Models AD12(A)(B)(C)-(F5)(D), AD1212H(C)-(F5)(E), AD1224H(C)-(F5)(F), AD1226H(C)-(F5) where (A) may be 12, 24 or 48, (B) may be H, M or L, (C) may be S, B, V or X, (D) may be 1, 2 or 3, (E) may be 4, 5, 6 or 7, (F) may be 4 or 6.

Models AD12(A)(B)(C)-(A)(E), AD12(A)(B)(D)-(A)(E)GL, where (A) may be 12 or 24, (B) may be H, L or M, (C) may be B or S, (D) may be B, S or X, (E) may be 70 or 71.

Models AD2512(A), AD2524(A) where (A) may be MB, MS or MX.

Models AD08, AD09 followed by (A)(B)(C)-A5(D) where (A) maybe 12 or 24, (B) may be H, L or M, (C) may be B or S, (D) may be 2 or 3.

Models AD0212HB-C71, AD0405HB-C91, AD0405HS-C91, AD0405MB-E81, -G91, AD0405MS-C91, AD0406MB-E81, AD0412HB-E81, -G91, AD0412HS-E81, -G91, AD0412LB-E81, AD0412LS-E81, AD0412MB-E81, -G91, AD0412MS-E81, -G91, AD0605HB-D71, AD0612HB-D71, AD0612HS-D71, AD0612LB-D71, AD0612LS-D71, AD0612MS-D71.

Models AD0 followed by 6 or 8, followed by 12 or 24, followed by H, L or M, followed by S or B, followed by A or C, followed by 50GL, 51GL, 70GL or 71GL.

Model AD75(A)(B)(C), where (A) may be 12 or 24, (B) may be H or M, (C) may be B, S or X.

Models AD04(A)(B)(C)-G70, AD0403L(C)-G70, AD0405(D)(C)-K96, AD0424(B)(C)-C70, where (A) may be 05 or 12, (B) may be H or M, (C) may be B, S or X, (D) may be H, L or M; Model BD0412MS-G70.

Models AA128(A)(B)(C)-(D), AA838(A)(E)(C)-(F), where (A) may be 1 or 2, (B) may be D, H, L or M, (C) may be B, S or X, (D) may be AT, AW, PT or PW, (E) may be H or M, (F) may be AT or AW.

Model AD05(A)(B)(C)-(D), AD0505(E)(C)-G76, AD0512(E)(C)-(F), AD0512M(C)-D76, where (A) may be 05 or 12, (B) may be H or M, (C) may be B, S or X, (D) may be D70, D71 or G90, (E) may be H, L or M, (F) may be G70 or G76.

Models AD08(A)(B)(C)-D71, AD08(D)UB-A(E)GL, AD0812(B)B-D74 where (A) may be 05 or 12, (B) may be H or M, (C) may be B, S or X, (D) may be 12 or 24, (E) may be 71, 72 or 73.

Models AD06(A)(B)(C)-(E), AD06(A)(D)(C)-G90, AD0612(D)(C)-G96, where (A) may be 05 or 12, (B) may be H or M, (C) may be B, S or X, (D) may be H, L or M, (E) may be D71GL, D72GL or D73GL.

349050002

Page 1 of 2

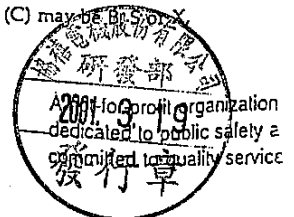

Underwriters Laboratories Inc.®

Model AD02(A)L(B)-G70, where (A) may be 05 or 12, (B) may be B, S or X; Model AD0205L(C)-G50, where (C) may be B or X.
Models AD09(A)H(C)-A74GL, AD0912(B)(C)-A76GL, where (A) may be 12 or 24, (B) may be H, L or M, (C) may be B, S or X.
Models AD0912(A)(Y)-A(W)GL, AD0912(A)(Y)-A2GL, where (A) may be H, L, M or U, (Y) may be B, S or X, (W) may be 71, 72 or 73.
Model AD0924XY-A7ZGL.
Models AD4505H(B)-G70, AD4512(A)(B)-(C), where (A) may be H or M, (B) may be B, S or X, (C) may be G7 or G76.
Model AD1224(A)(B)-A74GL, where (A) may be H, L or M, (B) may be B, S or X.
Models AD0305L(X)-K70, AD0312L(X)-K70 where (X) may be B or X; Model AD0424M(B)-G70.
Models AD0412H(Y)-D50, AD0412H(Y)-D56, AD0412L(Y)-D50, AD0412L(Y)-D56, AD0412M(Y)-D50, AD0412M(Y)-D56 where (Y) may be B, S or X.
Model AD0612M(B)-D70GL where (B) may be B, S or X; Model AD0812MB-D76.
Models AD0612H(Y)-A76GL, AD0612L(Y)-A76GL, AD0612M(Y)-A76GL where (Y) may be B, S or X.
Models AD0612D(Y)-D70GL, AD0612D(Y)-D76GL, AD0612H(Y)-D70GL, AD0612H(Y)-D76GL, AD0612L(Y)-D70GL, AD0612L(Y)-D76GL, AD0612M(Y)-D70GL, AD0612M(Y)-D76GL, AD0624H(Y)-D70GL, AD0624H(Y)-D76GL, AD0624M(Y)-D70GL, AD0624M(Y)-D76GL, where (Y) may be B, S or X.
Models AD0305L(X)-K70, AD0312L(X)-K70, where (X) may be B or X; Model AD0424MB-G70.
Model AD0612M(B)-D70GL, where (B) may be B, S or X; Model AD0812MB-D76.
Models AD0612H(Y)-A76GL, AD0612M(Y)-A76GL, AD0612L(Y)-A76GL, where (Y) may be B, S or X.
Model AD0624UX-A79GL.
Models AD0612XY-C72GL, AD0612XY-C76GL, AD0612XY-C76GL, AD0624XY-C70GL, AD0624XY-C76GL Series where X may be H, L or M, Y may be B, S or X.

Marking: Company name or trademarks  and model designation.

See General Information Preceding These Recognitions

For use only in equipment where the acceptability of the combination is determined by Underwriters Laboratories Inc.

349050002

Page 2 of 2

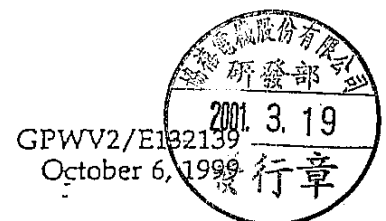



TÜV Rheinland

Technischer Überwachungs-Verein Rheinland

Appendix to TÜV Rheinland Bauart Mark Certificate No. R 2055847

Model	Rating	CFM	Model	Rating	CFM
AB4505HB-GD1	5Vdc, 0.22A	2.7	AB0505LB-RB1	5Vdc, 0.12A	2.3
AB4505HS-GD1	5Vdc, 0.22A	2.7	AB0505LS-RB1	5Vdc, 0.12A	2.3
AB4505HX-GD1	5Vdc, 0.22A	2.7	AB0505LX-RB1	5Vdc, 0.12A	2.3
AB4505MB-GD1	5Vdc, 0.15A	2.3	AB0505MB-RB3	5Vdc, 0.17A	3.0
AB4505MS-GD1	5Vdc, 0.15A	2.3	AB0505MS-RB3	5Vdc, 0.17A	3.0
AB4505MX-GD1	5Vdc, 0.15A	2.3	AB0505MX-RB3	5Vdc, 0.17A	3.0
AB4505LB-GD1	5Vdc, 0.13A	1.8	AB0505LB-RB3	5Vdc, 0.12A	2.3
AB4505LS-GD1	5Vdc, 0.13A	1.8	AB0505LS-RB3	5Vdc, 0.12A	2.3
AB4505LX-GD1	5Vdc, 0.13A	1.8	AB0505LX-RB3	5Vdc, 0.12A	2.3
AB4505HB-GD3	5Vdc, 0.22A	2.7	AD4505HB-G7B	5Vdc, 0.13A	8.2
AB4505HS-GD3	5Vdc, 0.22A	2.7	AD4505HX-G7B	5Vdc, 0.13A	8.2
AB4505HX-GD3	5Vdc, 0.22A	2.7	AD4505HS-G7B	5Vdc, 0.13A	8.2
AB4505MB-GD3	5Vdc, 0.15A	2.3	AD0505HB-G7B	5Vdc, 0.16A	11.2
AB4505MS-GD3	5Vdc, 0.15A	2.3	AD0505HX-G7B	5Vdc, 0.16A	11.2
AB4505MX-GD3	5Vdc, 0.15A	2.3	AD0505HS-G7B	5Vdc, 0.16A	11.2
AB4505LB-GD3	5Vdc, 0.13A	1.8	AD0405HB-G7B	5Vdc, 0.13A	6.7
AB4505LS-GD3	5Vdc, 0.13A	1.8	AD0405HX-G7B	5Vdc, 0.13A	6.7
AB4505LX-GD3	5Vdc, 0.13A	1.8	AD0405HS-G7B	5Vdc, 0.13A	6.7
AB0505MB-RB1	5Vdc, 0.17A	3.0	AD0305HB-G73	5Vdc, 0.11A	3.3
AB0505MS-RB1	5Vdc, 0.17A	3.0	AD0305MB-G73	5Vdc, 0.09A	2.9
AB0505MX-RB1	5Vdc, 0.17A	3.0			

Date: 09. 08. 2000

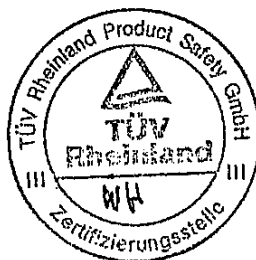

Certification Body

W. Hsu
Dipl.-Ing. Windah Hsu

1/1

