

7000 series

Rocker and paddle switches

Distinctive features and specifications



- ❑ Wide variety of actuators
- ❑ Many mounting styles for panel or PCB
- ❑ VDE, UL and CSA approved

ELECTRICAL SPECIFICATIONS

- Current/voltage rating with resistive load :

Contact	Maximum	Minimum	Level *
Silver A	3A 250VAC - 6A 125VAC - 4A 30VDC	50mA 10VDC	III and IV
Silver, gold plated AD	3A 250VAC - 6A 125 VAC - 4A 30VDC Gold plating withstands up to 100mA 30VDC.	10mA 50mV 10µA 5V	I to IV
Brass, gold plated CD	0,4 VA at 20VAC or DC	10mA 50mV 10µA 5V	I and II

- For inductive, lamp or capacitive loads, consult factory. * For details, see technical information, end of catalogue.
- Initial contact resistance : 10 mΩ
- Insulation resistance : 1.000 MΩ min. at 500VDC
- Dielectric strength :
 - 1.000 Vrms 50 Hz min. between terminals
 - 1.500 Vrms 50 Hz min. between poles
 - 1.500 Vrms 50 Hz min. between terminals and frame
- Contact bounce : 2 ms max.
- Electrical life : 50.000 cycles at full load

MATERIALS

- Case : diallyphthalate (DAP) or high temperature plastic material (UL94-V0)
- Actuator : polyamide
- Housing : stainless steel or steel tin plated
- Bracket : steel, tin plated
- Contacts
 - A : silver
 - AD : silver, gold plated
 - CD : brass, gold plated
- Terminal seal : epoxy

GENERAL SPECIFICATIONS

- Mechanical life : 100.000 cycles
- Panel thickness : 1 (.039) to 2,5 mm(.098)
- Operating temperature : -40°C to +85°C

AGENCY APPROVALS



EN 61058-1



For VDE, refer to 57000 series.

Availability : consult factory for details of approved models.

Marking : to order switches marked UL or CSA, complete appropriate box of ordering format.

7000 series

Rocker and paddle switches

Overview

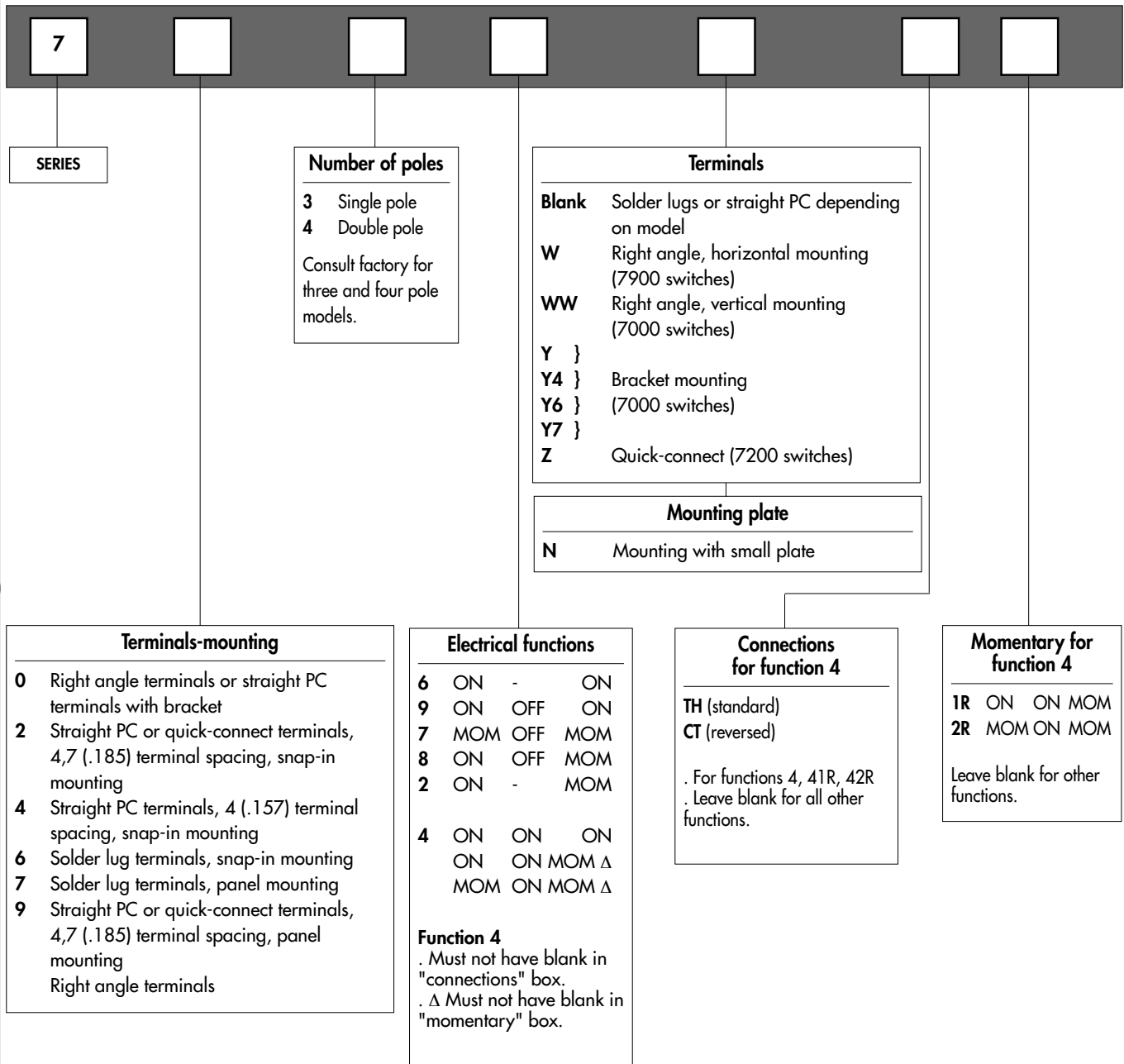
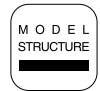

ABOUT THIS SERIES

On the following pages, you will find successively :

- model structure of switches
- options in the same order as in above chart

Dimensions : first dimensions are in mm while inches are shown as bracketted numbers.



NOTICE : please note that not all combinations of above numbers are available. Refer to the following pages for further information.



7000 series

Rocker and paddle switches

Overview

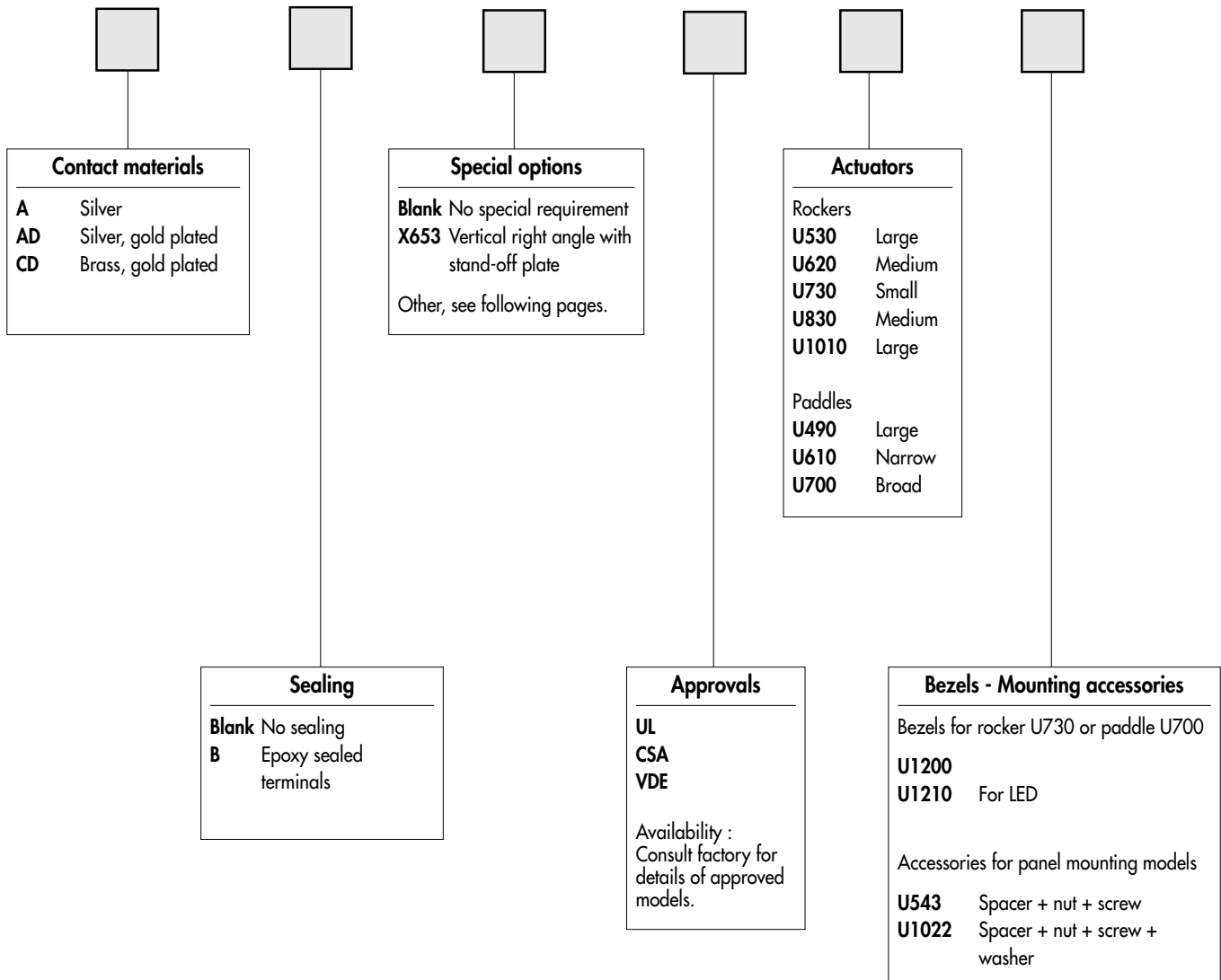

Packaging unit : 25 pieces.

7000 series

Rocker and paddle switches

Snap-in mounting : 7600 - 7200 - 7400

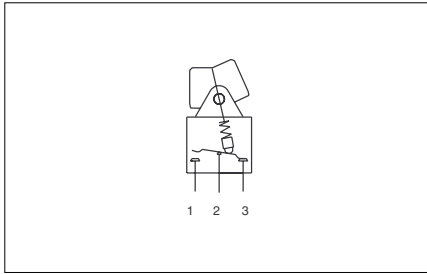

- Solder lug or straight PC terminals
- Epoxy sealing standard on models with straight PC terminals

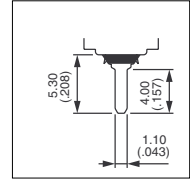
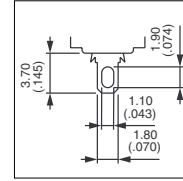

MODEL STRUCTURE

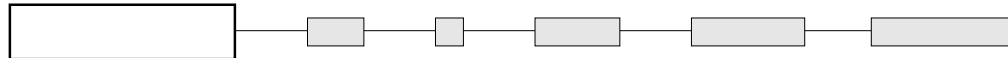

Shown with rocker U730 and bezel U1200

Solder lug terminals : 7600



Single pole	Double pole
7636	7646
7639	7649
7637	7647
7638	7648
7632	7642
	7644*
	7644 1R*
	7644 2R*

III	II	I
2-3		1-2
5-6		4-5
ON	-	ON
ON	OFF	ON
MOM	OFF	MOM
ON	OFF	MOM
ON	-	MOM
ON	ON	ON
ON	ON	MOM
MOM	ON	MOM

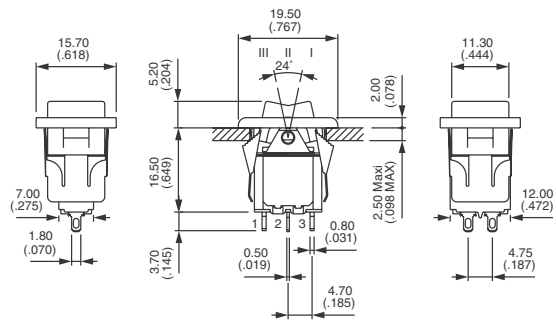

Straight PC terminals - spacing 4,7 (.185) : 7200



Single pole	Double pole
7236 B	7246 B
7239 B	7249 B
7237 B	7247 B
7238 B	7248 B
7232 B	7242 B
	7244 B*
	7244 1R B*
	7244 2R B*

III	II	I
2-3		1-2
5-6		4-5
ON	-	ON
ON	OFF	ON
MOM	OFF	MOM
ON	OFF	MOM
ON	-	MOM
ON	ON	ON
ON	ON	MOM
MOM	ON	MOM

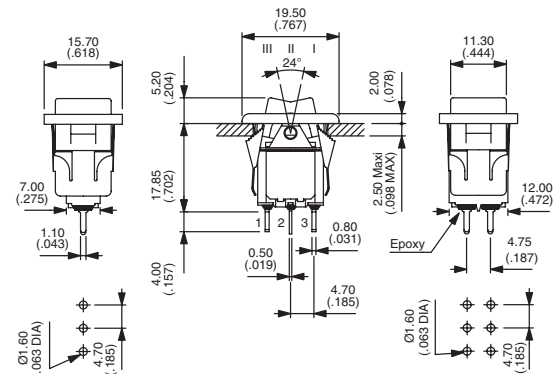

Straight PC terminals - spacing 4 (.157) : 7400



Single pole	Double pole
7436 B	7446 B
7439 B	7449 B
7437 B	7447 B
7438 B	7448 B
7432 B	7442 B
	7444 B*
	7444 1R B*
	7444 2R B*

III	II	I
2-3		1-2
5-6		4-5
ON	-	ON
ON	OFF	ON
MOM	OFF	MOM
ON	OFF	MOM
ON	-	MOM
ON	ON	ON
ON	ON	MOM
MOM	ON	MOM

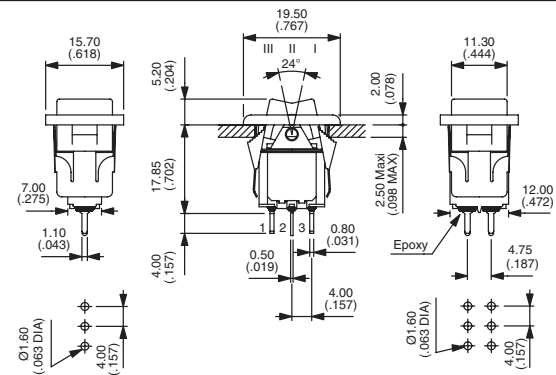

* Function 4 : SP in DP case - specify CT or TH connections, see end of catalogue.



7000 series

Rocker and paddle switches

Snap-in mounting : 7200Z

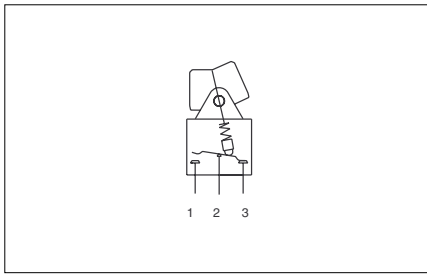

• Quick-connect terminals

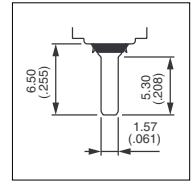

MODEL STRUCTURE

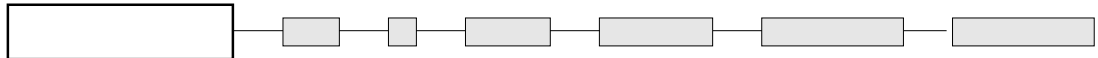

Shown with rocker U730 and bezel U1200

Quick-connect terminals : 7200Z



Single pole	Double pole
7236Z	7246Z
7239Z	7249Z
7237Z	7247Z
7238Z	7248Z
7232Z	7242Z
	7244Z*
	7244Z 1R*
	7244Z 2R*

III	II	I
2-3		1-2
5-6		4-5
ON	-	ON
ON	OFF	ON
MOM	OFF	MOM
ON	OFF	MOM
ON	-	MOM
ON	ON	ON
ON	ON	MOM
MOM	ON	MOM

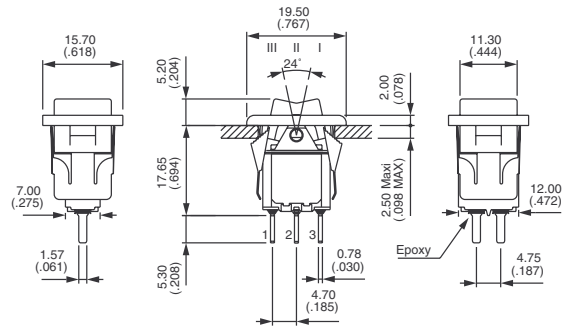

* Function 4 : SP in DP case - specify CT or TH connections, see end of catalogue.

PANEL CUT-OUT

7600 - 7200 - 7400 - 7200Z

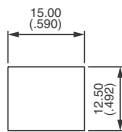

With or without bezel U1200

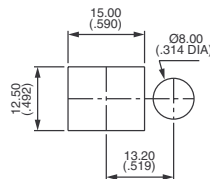

With bezel U1210



7000 series

Rocker and paddle switches

Panel mounting : 7700 - 7900

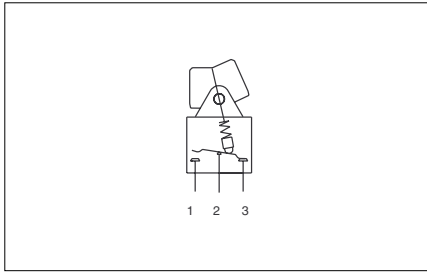
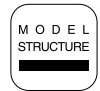

- Large rocker or paddle
- Solder lug or straight PC terminals
- Quick-connect terminals : on request
- Epoxy sealing standard on models with straight PC terminals

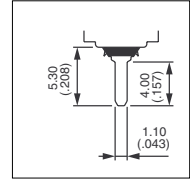
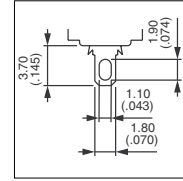

MODEL STRUCTURE

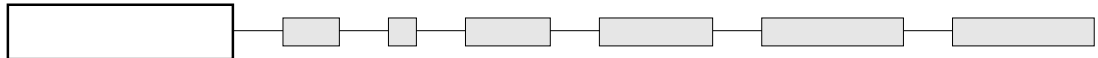

Shown with rocker U530

Solder lug terminals : 7700



Single pole	Double pole
7736	7746
7739	7749
7737	7747
7738	7748
7732	7742
	7744*
	7744 1R*
	7744 2R*

III	II	I
2-3		1-2
5-6		4-5
ON	-	ON
ON	OFF	ON
MOM	OFF	MOM
ON	OFF	MOM
ON	-	MOM
ON	ON	ON
ON	ON	MOM
MOM	ON	MOM

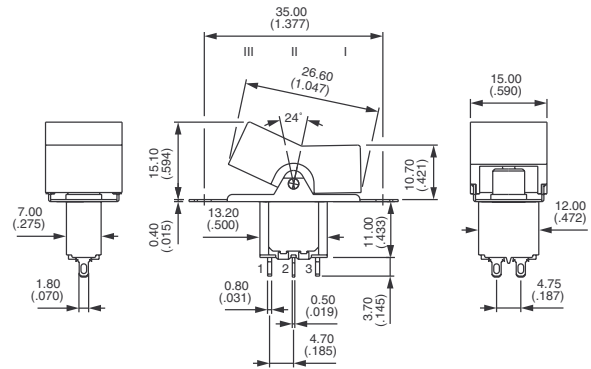

Straight PC terminals : 7900



Single pole	Double pole
7936 B	7946 B
7939 B	7949 B
7937 B	7947 B
7938 B	7948 B
7932 B	7942 B
	7944 B*
	7944 1R B*
	7944 2R B*

III	II	I
2-3		1-2
5-6		4-5
ON	-	ON
ON	OFF	ON
MOM	OFF	MOM
ON	OFF	MOM
ON	-	MOM
ON	ON	ON
ON	ON	MOM
MOM	ON	MOM

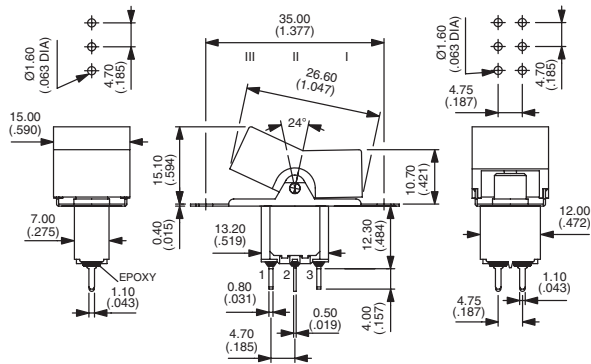

* Function 4 : SP in DP case - specify CT or TH connections, see end of catalogue.

PANEL CUT-OUT

7700 - 7900

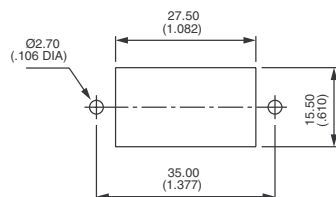



7000 series

Rocker and paddle switches

Panel mounting : 7700N - 7900N

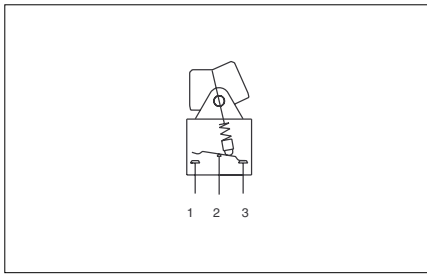

- Small or medium rocker or paddle
- Solder lug or straight PC terminals
- Quick-connect terminals : on request
- Epoxy sealing standard on models with straight PC terminals

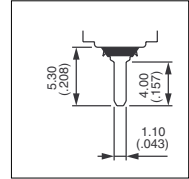
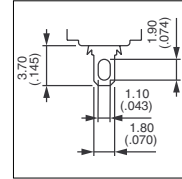

MODEL STRUCTURE

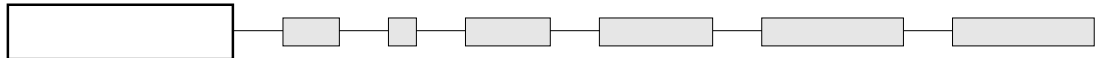

Shown with rocker U620

Solder lug terminals : 7700N



Single pole	Double pole
7736N	7746N
7739N	7749N
7737N	7747N
7738N	7748N
7732N	7742N
	7744N*
	7744N 1R*
	7744N 2R*

III	II	I
2-3		1-2
5-6		4-5
ON	-	ON
ON	OFF	ON
MOM	OFF	MOM
ON	OFF	MOM
ON	-	MOM
ON	ON	ON
ON	ON	MOM
MOM	ON	MOM

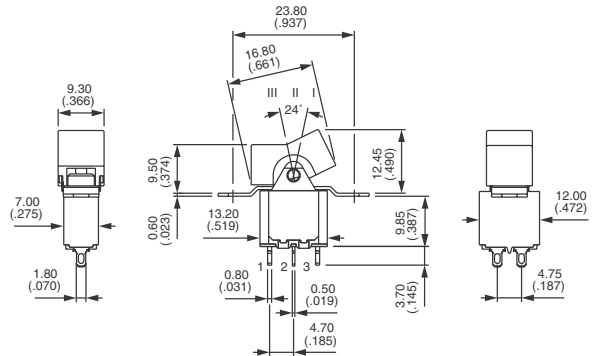

Straight PC terminals : 7900N



Single pole	Double pole
7936N B	7946N B
7939N B	7949N B
7937N B	7947N B
7938N B	7948N B
7932N B	7942N B
	7944N B*
	7944N 1R B*
	7944N 2R B*

III	II	I
2-3		1-2
5-6		4-5
ON	-	ON
ON	OFF	ON
MOM	OFF	MOM
ON	OFF	MOM
ON	-	MOM
ON	ON	ON
ON	ON	MOM
MOM	ON	MOM

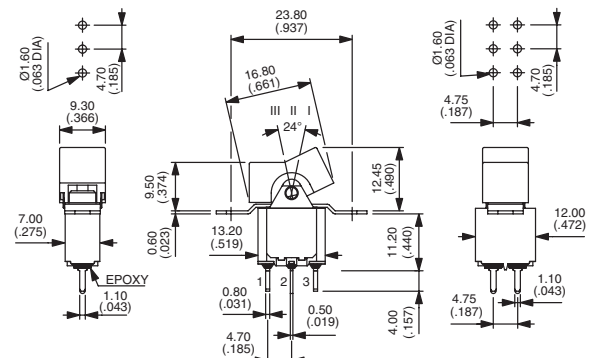

* Function 4 : SP in DP case - specify CT or TH connections, see end of catalogue.

PANEL CUT-OUT

7700N - 7900N

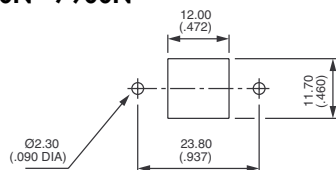

With small rocker U730
or small paddle U700

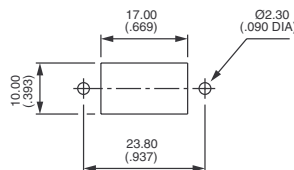

With medium rocker U620
or medium paddle U610

D

7000 series

Rocker and paddle switches

Right angle terminals - horizontal : 7900W

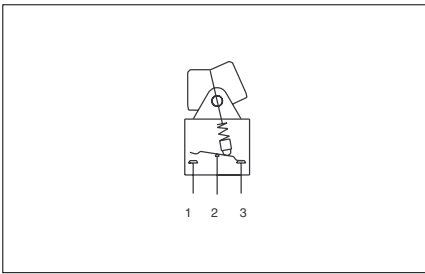
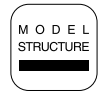

MODEL
STRUCTURE

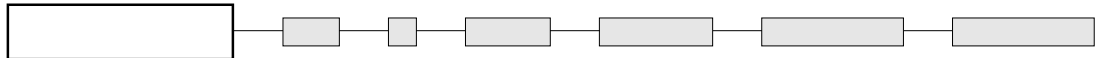

Shown with rocker U620

Single pole



7936W
7939W
7937W
7938W
7932W

III	II	I
2-3		1-2
ON	-	ON
ON	OFF	ON
MOM	OFF	MOM
ON	OFF	MOM
ON	-	MOM

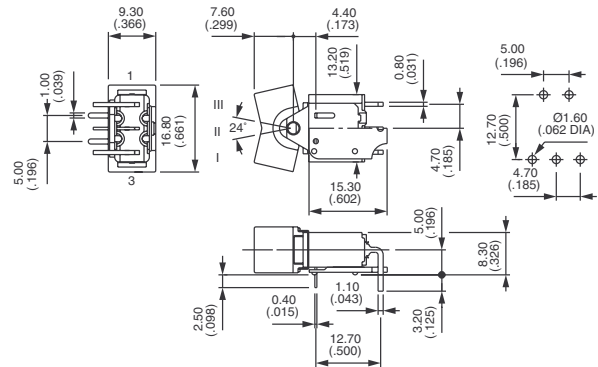

Double pole



7946W
7949W
7947W
7948W
7942W
7944W*
7944W 1R*
7944W 2R*

III	II	I
2-3		1-2
5-6		4-5
ON	-	ON
ON	OFF	ON
MOM	OFF	MOM
ON	OFF	MOM
ON	-	MOM
ON	ON	ON
ON	ON	MOM
MOM	ON	MOM

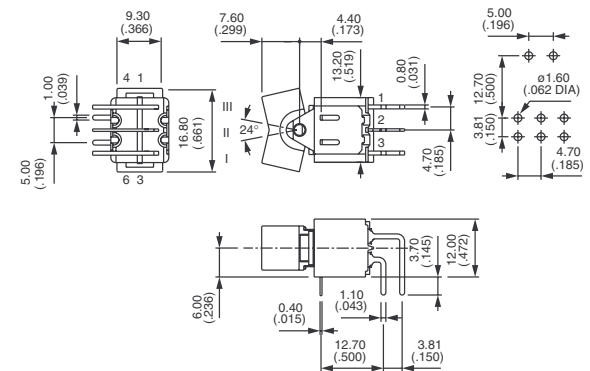

* Function 4 : SP in DP case - specify CT or TH connections, see end of catalogue.

PANEL CUT-OUT

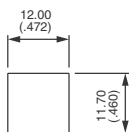

With small rocker **U730**
or small paddle **U700**

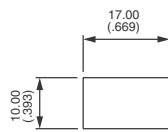

With medium rocker **U620**
or medium paddle **U610**

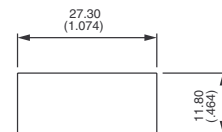

With large rocker **U1010**



7000 series

Rocker and paddle switches

Right angle terminals - vertical : 7000WW

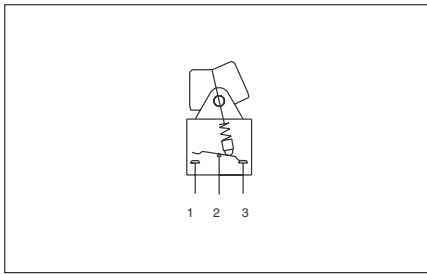

MODEL
STRUCTURE

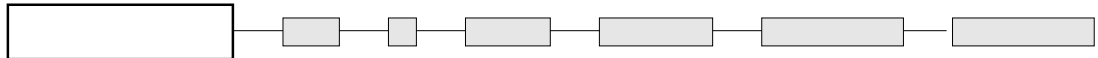

Shown with rocker U830

Single pole



7036WW
7039WW
7037WW
7038WW**
7032WW**

III	II	I
2-3		1-2
ON	-	ON
ON	OFF	ON
MOM	OFF	MOM
ON	OFF	MOM
ON	-	MOM

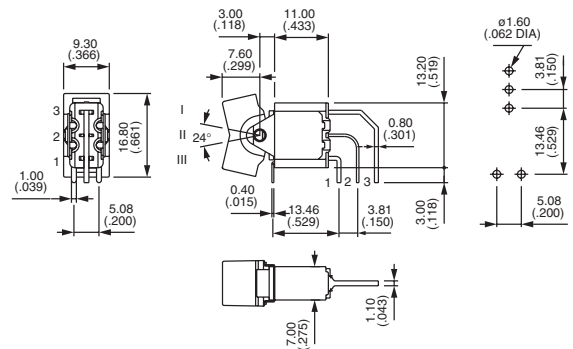

Double pole



7046WW
7049WW
7047WW
7048WW**
7042WW**
7044WW*
7044WW 1R*
7044WW 2R*

III	II	I
2-3		1-2
5-6		4-5
ON	-	ON
ON	OFF	ON
MOM	OFF	MOM
ON	OFF	MOM
ON	-	MOM
ON	ON	ON
ON	ON	MOM
MOM	ON	MOM

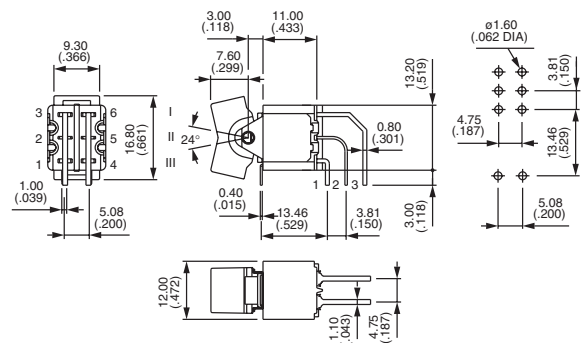

* Function 4 :SP in DP case - specify CT or TH connections, see end of catalogue.

** Functions 2 and 8 : reversed connection available. Consult factory.

PANEL CUT-OUT

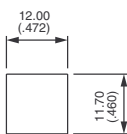

With small rocker **U730**

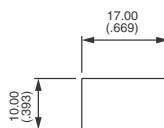

With medium rocker **U830**

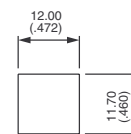

With broad paddle **U700**

7000 series

Rocker and paddle switches

Straight PC terminals - bracket mounting : 7000Y

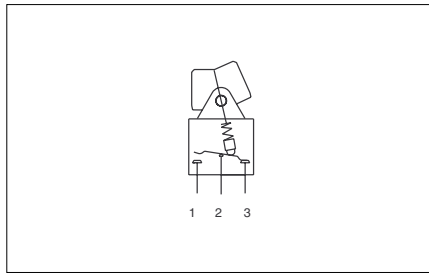
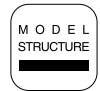

Brackets reduce mechanical stress on solder joints and increase the resistance to vibrations.

- Epoxy sealed terminals standard (B included in model structure)

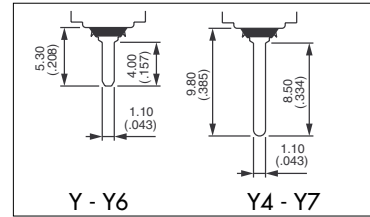

MODEL STRUCTURE

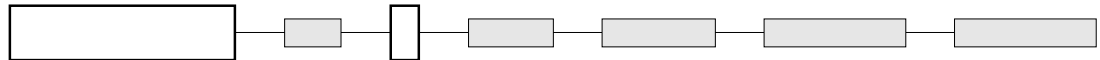

Shown with rocker U620

Short bracket - width 15,75 (.620) - single pole : 7030Y



7036Y B
7039Y B
7037Y B
7038Y B
7032Y B

III	II	I
2-3		1-2
5-6		4-5
ON	-	ON
ON	OFF	ON
MOM	OFF	MOM
ON	OFF	MOM
ON	-	MOM

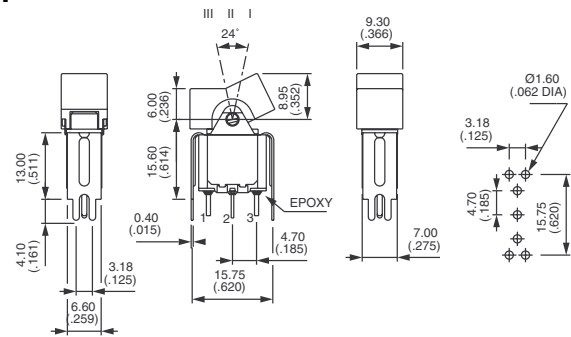

Short bracket - width 15,75 (.620) - double pole : 7040Y



7046Y B
7049Y B
7047Y B
7048Y B
7042Y B
7044Y* B
7044Y 1R* B
7044Y 2R* B

III	II	I
2-3		1-2
5-6		4-5
ON	-	ON
ON	OFF	ON
MOM	OFF	MOM
ON	OFF	MOM
ON	-	MOM
ON	ON	ON
ON	ON	MOM
MOM	ON	MOM

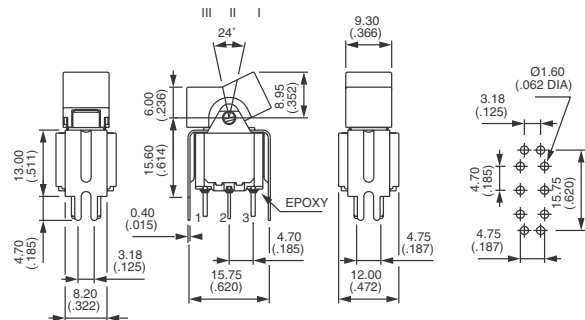

* Function 4 : SP in DP case - specify CT or TH connections, see end of catalogue.



7000 series

Rocker and paddle switches

Straight PC terminals - bracket mounting : 7000Y4 - Y6 - Y7

Tall bracket - width 15,75 (.620) : 7000Y4



Single pole	Double pole	III	II	I
7036Y4 B	7046Y4 B	2-3	-	1-2
7039Y4 B	7049Y4 B	5-6	-	4-5
7037Y4 B	7047Y4 B		ON	MOM
7038Y4 B	7048Y4 B		OFF	OFF
7032Y4 B	7042Y4 B		-	MOM
	7044Y4* B		ON	ON
	7044Y4 1R* B		ON	MOM
	7044Y4 2R* B		MOM	MOM

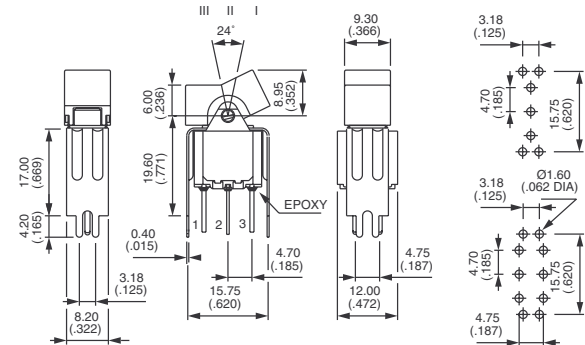

Short bracket - width 19,05 (.750) : 7000Y6



Single pole	Double pole	III	II	I
7036Y6 B	7046Y6 B	2-3	-	1-2
7039Y6 B	7049Y6 B	5-6	-	4-5
7037Y6 B	7047Y6 B		ON	MOM
7038Y6 B	7048Y6 B		OFF	OFF
7032Y6 B	7042Y6 B		-	MOM
	7044Y6* B		ON	ON
	7044Y6 1R* B		ON	MOM
	7044Y6 2R* B		MOM	MOM

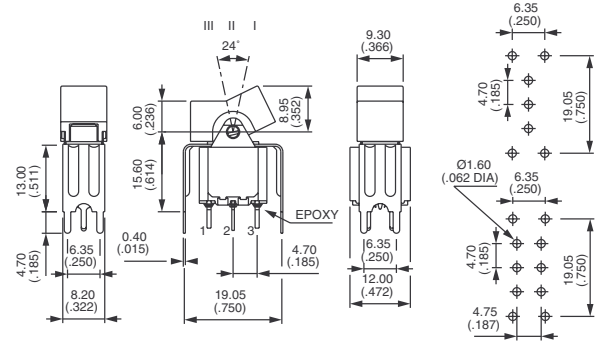

Tall bracket - width 19,05 (.750) : 7000Y7



Single pole	Double pole	III	II	I
7036Y7 B	7046Y7 B	2-3	-	1-2
7039Y7 B	7049Y7 B	5-6	-	4-5
7037Y7 B	7047Y7 B		ON	MOM
7038Y7 B	7048Y7 B		OFF	OFF
7032Y7 B	7042Y7 B		-	MOM
	7044Y7* B		ON	ON
	7044Y7 1R* B		ON	MOM
	7044Y7 2R* B		MOM	MOM

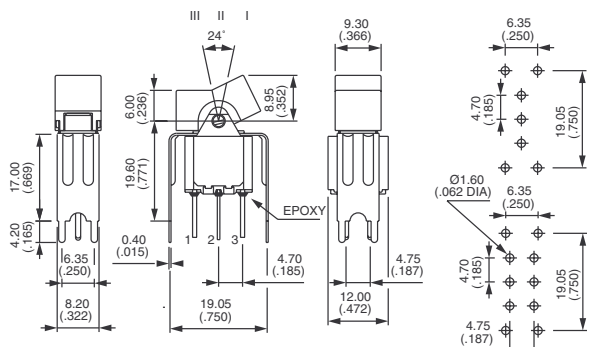

* Function 4 :SP in DP case - specify CT or TH connections, see end of catalogue.

PANEL CUT-OUT

7000Y - Y4 - Y6 - Y7

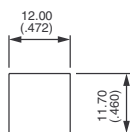

With small rocker **U730**
or small paddle **U700**

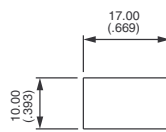

With medium rocker **U620**
or medium paddle **U610**

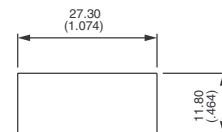

With large rocker **U1010**

7000 series

Rocker and paddle switches



CONTACT MATERIALS

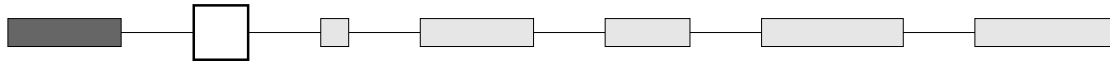

- A Silver
- AD Silver, gold plated
- CD Brass, gold plated

SEALING

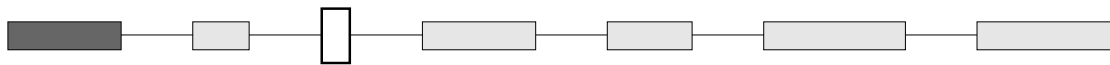

- Blank No sealing
- B Epoxy sealed terminals



D

SPECIAL OPTIONS

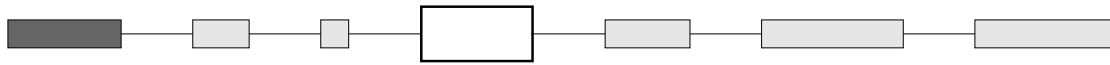

- Blank No special requirement
- X653 Vertical right angle with stand-off plate

Shown with rocker U620



	III	II	I
	2-3		1-2
	5-6		4-5
Single pole			
7036WW X653	7046WW X653	ON - ON	
7039WW X653	7049WW X653	ON OFF ON	
7037WW X653	7047WW X653	MOM OFF MOM	
7038WW X653	7048WW X653**	ON OFF MOM	
7032WW X653	7042WW X653**	ON - MOM	
	7044WW X653*	ON ON ON	
	7044 1RWW X653*	ON ON MOM	
	7044 2RWW X653*	MOM ON MOM	

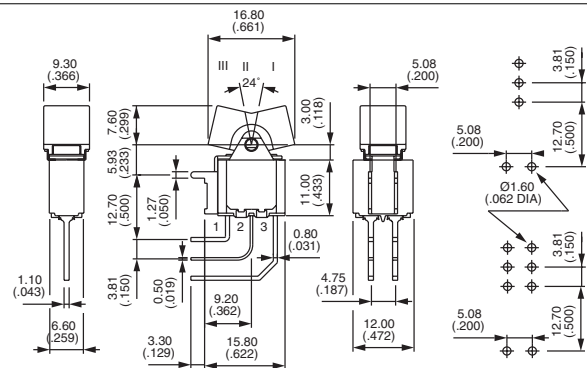

* Function 4 : SP in DP case - specify CT or TH connections, see end of catalogue.
 ** Functions 2 and 8 : reversed connection available. Consult factory.

Actuators for X653 : small rocker U730 and medium rocker U620, broad paddle U700 and narrow paddle U610.

- X601 Silver plated brass contacts
 Current voltage rating for an electrical life of 20.000 cycles : 0,2A 250VAC - 0,4A 125VAC - 0,5A 30VDC
 Minimum quantity : 5.000 pieces per model and shipment.



7000 series

Rocker and paddle switches

AGENCY APPROVALS

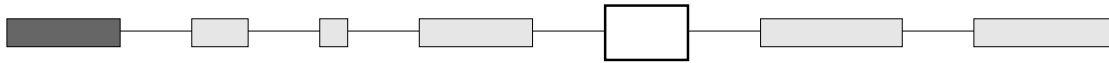

UL - CSA

All standard models

Availability : consult factory for details of approved combinations or options.

Marking : to order switches marked UL or CSA, complete above box with desired approvals.

Blank : no agency approval required.

VDE - UL - CSA

Refer to **57000** series on the following pages.

ACTUATORS

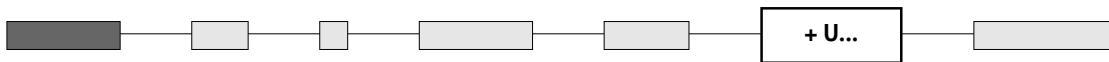

For snap-in mounting models : 7600 - 7200 - 7400 - 7200Z

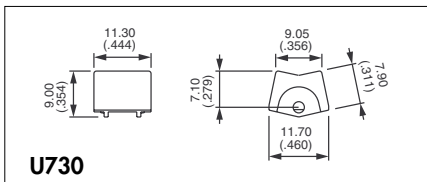

U730

Small rocker

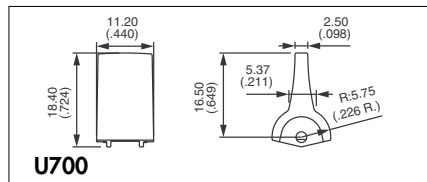

U700

Broad paddle

Actuator colours	
Replace last "0" by number	
1	blue
1/4	dark blue
2	black
3	green
4	grey
5	yellow
6	red
7	ivory
7/1	white
9	orange

For 7700 and 7900 models

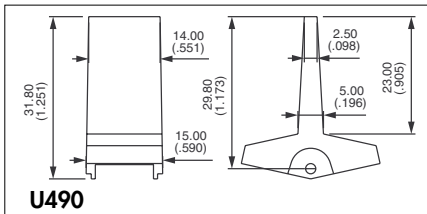

U490

Large paddle

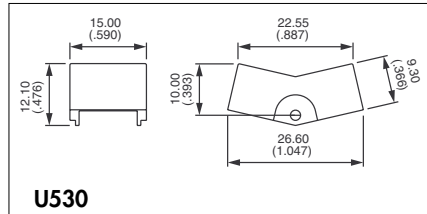

U530

Large rocker

For 7700N - 7900N - 7900W - 7000WWX653 and 7000Y models

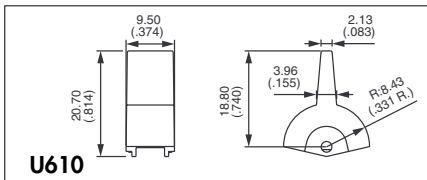

U610

Narrow paddle

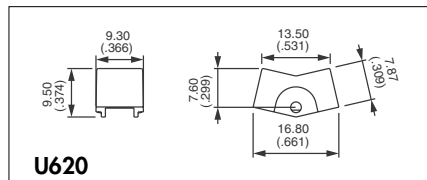

U620

Medium rocker

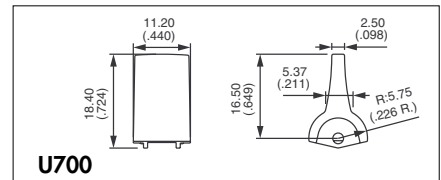

U700

Broad paddle

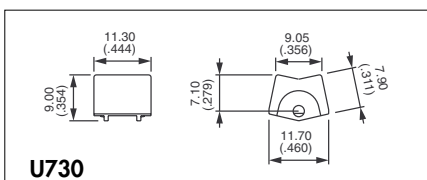

U730

Small rocker

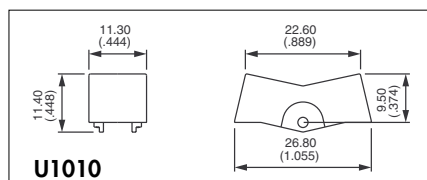

U1010

Large rocker
For 7900W, available on DP only.

7000 series

Rocker and paddle switches



ACTUATORS (continued)

For 7000WW models

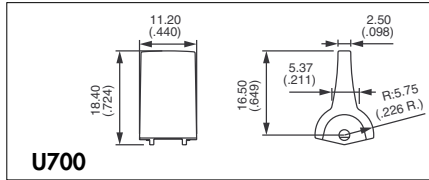

U700

Broad paddle

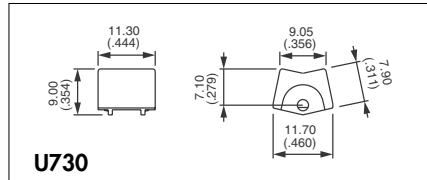

U730

Small rocker

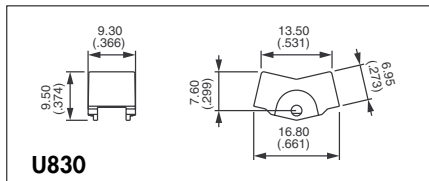

U830

Medium rocker

Actuator colours	
Replace last "0" by number	
1	blue
1/4	dark blue
2	black
3	green
4	grey
5	yellow
6	red
7	ivory
7/1	white
9	orange

BEZELS - MOUNTING ACCESSORIES



Bezels for paddle U700 and rocker U730

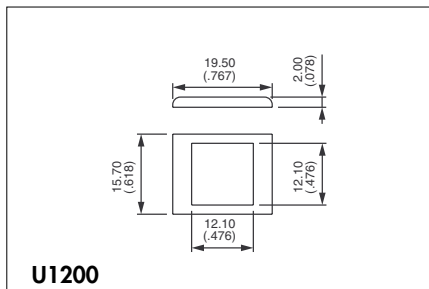

U1200

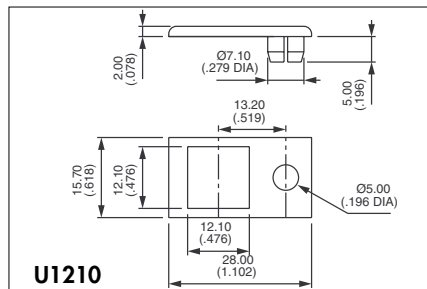

U1210

For LED Ø 5 (.196) - not supplied

Bezel colours	
Replace last "0" by number	
1	blue
1/4	dark blue
2	black
3	green
4	grey
5	yellow
6	red
7	ivory
7/1	white
9	orange

STANDARD PANEL MOUNTING

Panel thickness with bezel 1 to 2,5 mm (.039 to .098)

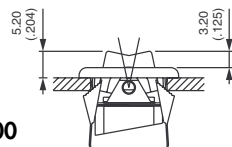

U730 + U1200

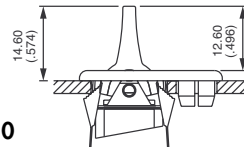

U700 + U1210

Mounting accessories

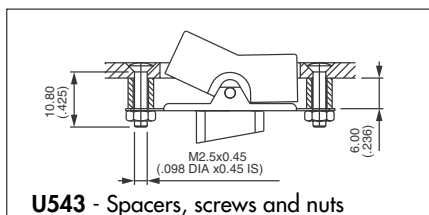

U543 - Spacers, screws and nuts

For rocker U530 or paddle U490

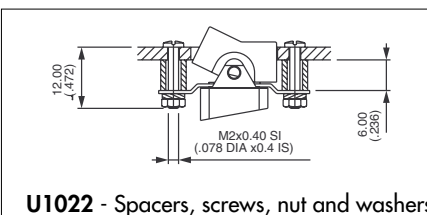

U1022 - Spacers, screws, nut and washers

For rockers U620 or U730
For paddles U610 or U700