

EM-27012-000
SHT 1.1

NOTE:

1. INCREASED PRESSURE AT SOUND INLET CAUSES A POSITIVE GOING VOLTAGE TO APPEAR AT THE OUTPUT TERMINAL, RELATIVE TO THE NEGATIVE TERMINAL.

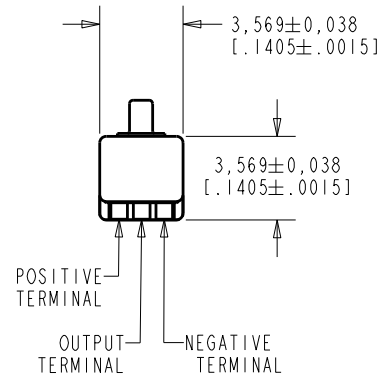
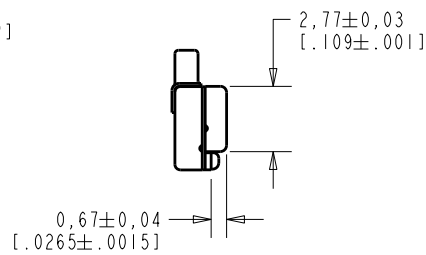
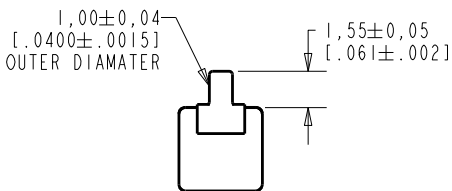
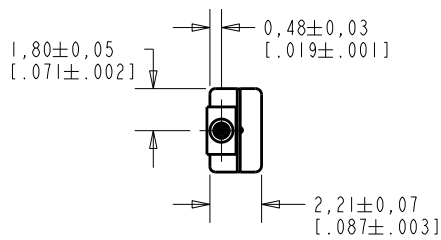

NOMINAL WEIGHT
.08 GRAMS

DIMENSIONS IN MILLIMETERS [INCHES]

Revision	C.O. #	Implementation Date	RELEASE LEVEL	REVISION
B	MI0102070	12-30-08	Active	B
A	MI0101356	1-18-07		
SCALE: 4:1			DR. BY	DATE
DO NOT SCALE DRAWING			LSY	1-18-07
			CK. BY	DATE
TITLE: MICROPHONE		EM-27012-000	GJP	1-26-07
			APP. BY	DATE
OUTLINE DRAWING		SHT 1.1	GJP	1-26-07

HE111ASIZE.FRM Rev: B



KNOWLES ELECTRONICS
ITASCA, ILLINOIS U.S.A.

PROPRIETARY NOTE: THIS DOCUMENT CONTAINS INFORMATION WHICH IS THE PROPRIETARY PROPERTY OF KNOWLES ELECTRONICS, LLC. OR ITS AFFILIATED ENTITIES. IT IS ISSUED IN STRICT CONFIDENCE AND SHALL NOT BE REPRODUCED, COPIED, USED, OR DISCLOSED TO ANY THIRD PARTY PARTIALLY OR WHOLLY IN ANY MANNER WITHOUT PRIOR WRITTEN PERMISSION OF, AND MUST BE RETURNED UPON REQUEST BY, KNOWLES ELECTRONICS, LLC.

EM-27012-000

NOTES:

1. ITEM NUMBERS (SHOWN THUS ) ON DRAWING CORRESPOND WITH ITEM NUMBERS ON BILL OF MATERIAL.

-  AIRTIGHT SEAL ALL AROUND.
-  AIRTIGHT SEAL ALONG EDGE OF TUBE FLANGE.

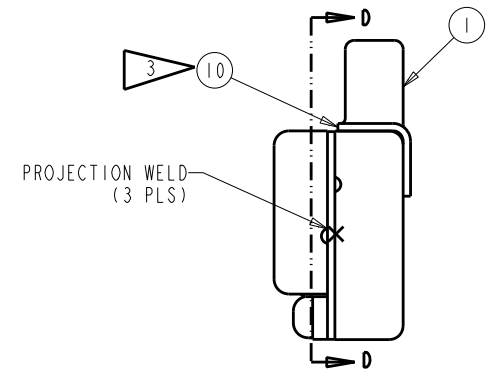
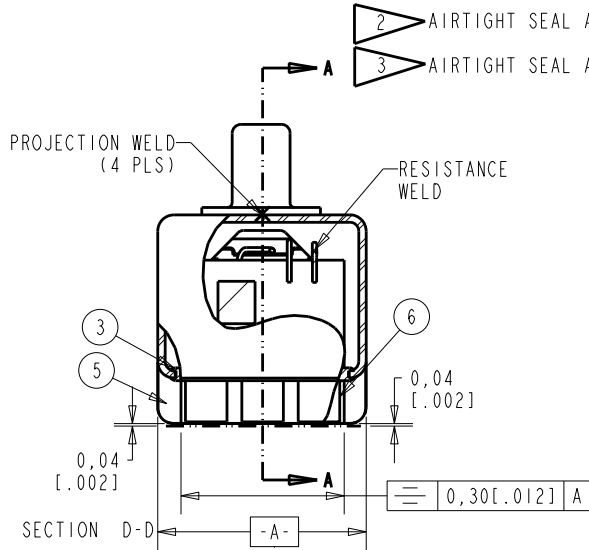
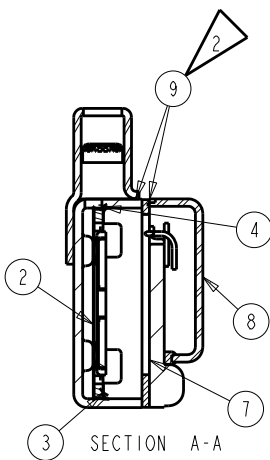

DIMENSIONS IN MILLIMETERS [INCHES]

RELEASE LEVEL	REVISION
Active	B
SCALE: 10:1	DO NOT SCALE DRAWING

MATERIAL SEE BILL OF MATERIAL

FINISH ---

KNOWLES ELECTRONICS
ITASCA, ILLINOIS U.S.A.

DR. BY	DATE
LSY	1-18-07
CH. BY	DATE
GJP	1-26-07
APP. BY	DATE
GJP	1-26-07

REF.	NONE
A	c.o. M10101356
B	c.o. M10102070
MODIFIED SHEET 1.1 SDZ 12-30-08	

UNLESS OTHERWISE SPECIFIED, DIMENSIONS ARE IN INCHES.

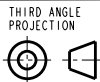

TITLE
MICROPHONE ASSEMBLY

EM-27012-000
 SHEET 3.1