

# System Configuration

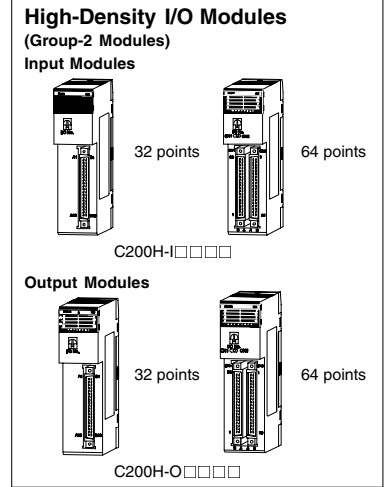
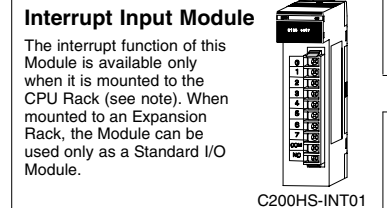
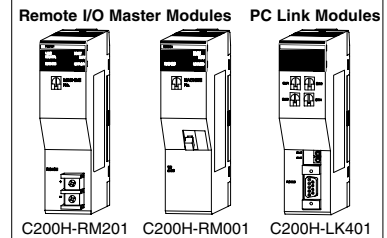
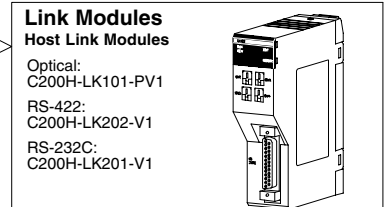
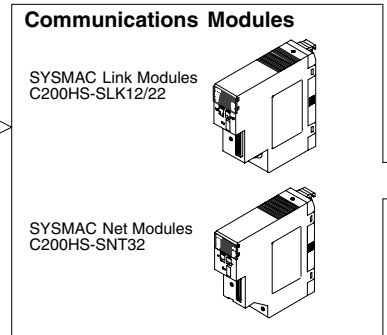
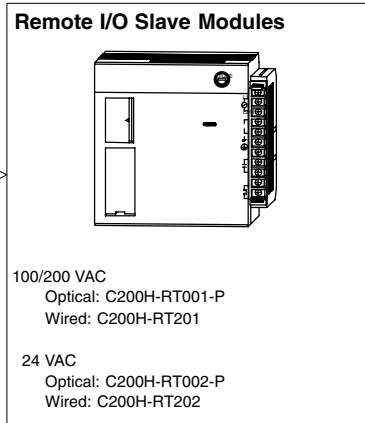
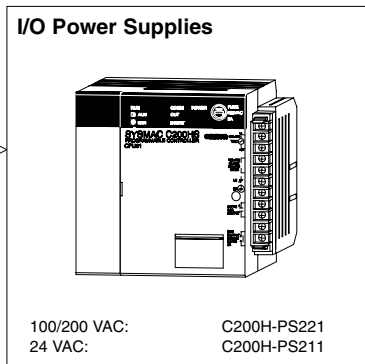
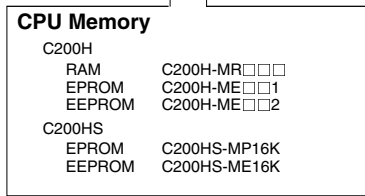
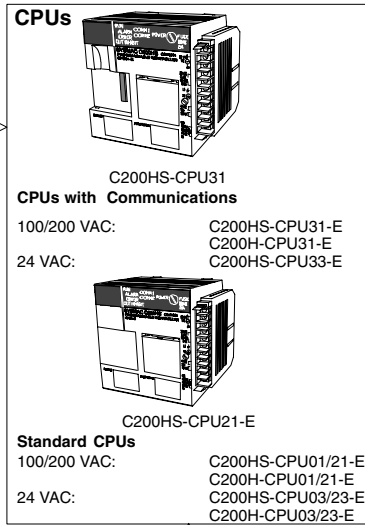
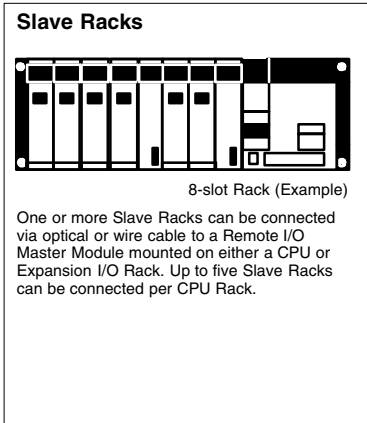
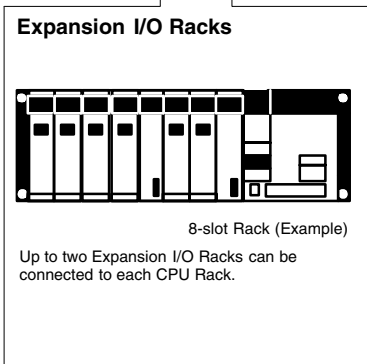
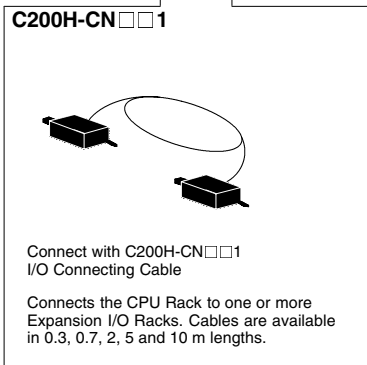
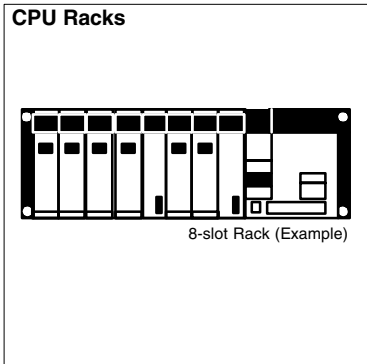

**Note:** Only one Interrupt Input Module can be used with a CPU.

# System Configuration

## Special I/O Modules

Analog Input Modules Analog Output Modules

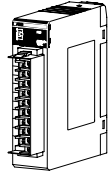

C200H-AD001/002

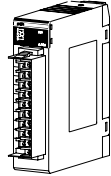

C200H-DA001

Temperature Sensor Modules

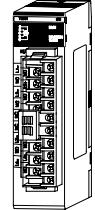

C200H-TS

Temperature Control Modules

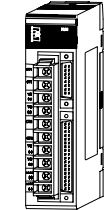

C200H-TC

Fuzzy Logic Module

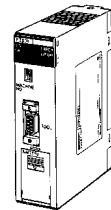

C200H-FZ001

PID Control Modules

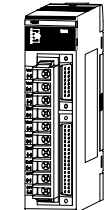

C200H-PID

High Speed Counter Modules

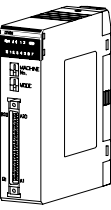

C200H-CT

Position Control Modules

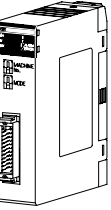

C200H-NC

Cam Position Modules



C200H-CP114

ID Sensor Module

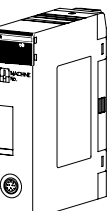

C200H-IDS

ASCII Module

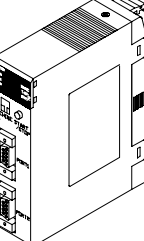

C200H-ASC02

Voice Module

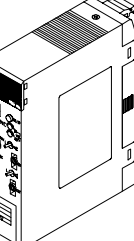

C200H-OV001

## I/O Modules

Input Modules (C200H-I)

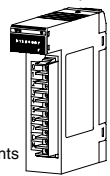

8 points

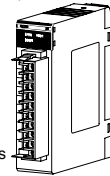

16 points

(AC, DC, AC/DC, transistor inputs)

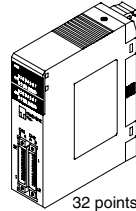

32 points

(Treated as Special I/O Module)

Output Modules (C200H-O)

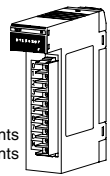

5 points

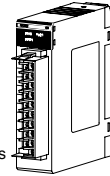

12 points

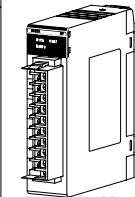

16 points

(Treated as Special I/O Module)

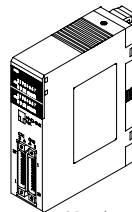

32 points

(Treated as Special I/O Module)

DC Input/Transistor Output Modules

C200H-MD (16 inputs and 16 outputs; treated as Special I/O Module.)

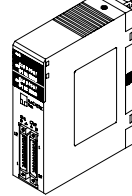

B7A Interface Modules

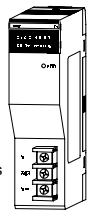

16 points Input

C200H-B7A11

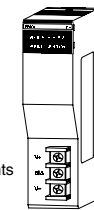

16 points Output

C200H-B7A01

Analog Timer Module

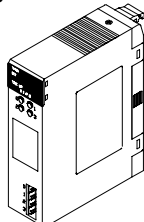

C200H-TM001

## Backplanes

The same Backplanes are used for CPU, Expansion I/O, and Slave Packs.

3-slot Backplane

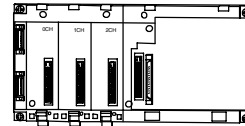

C200H-BC031-V2

5-slot Backplane

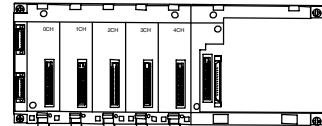

C200H-BC051-V2

8-slot Backplane

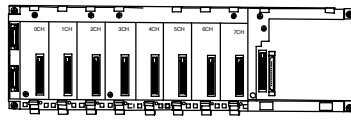

C200H-BC081-V2

10-slot Backplane



C200H-BC101-V2

# 8 Components

CPUs .....	8
Memory Packs .....	19
Backplanes .....	21
Special I/O Modules .....	22
Discrete Input/Output Modules .....	65
I/O Wiring Accessories .....	73
Input Wiring Accessories .....	75
Output Wiring Accessories .....	81
Remote Expansion .....	89
Communication Modules .....	94
Link Adapters .....	103

### General Information

The CPUs provide a wide variety of features and capabilities for applications requiring simplified configuration and ease of use, maximum reliability and maintainability, and the ability to meet the need for future change and system expansion. A variety of CPUs are available with various memory and I/O configurations allowing selection based on application requirements.

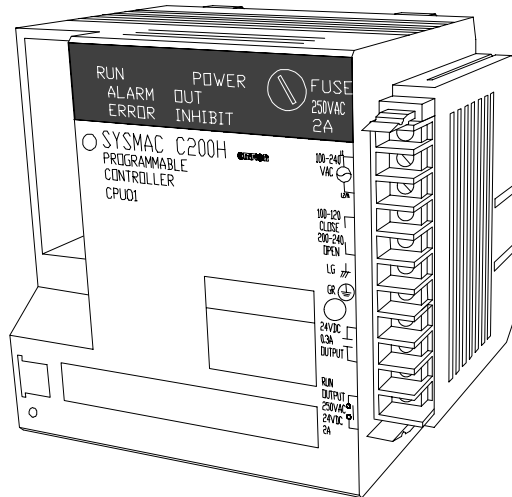

### C200H-CPU01-E/CPU03-E CPUs

#### High Spec, Small Rack Style, OEM Version

The C200H-CPU01-E and C200H-CPU03-E controllers offer big machine functions in a system designed ideally for basic OEM systems from 50 to 480 I/O. A wide variety of plug-in style I/O modules are available, including intelligent modules.

#### Basic Configuration

- ◆ Built-in 120 VAC (CPU01) or 24 VDC (CPU03) power supply
- ◆ Rack-style PLC with 3-, 5-, 8-, 10-slot racks
- ◆ Accepts two local expansion racks
- ◆ Accepts remote I/O racks

#### CPU Features

- ◆ 4K or 7K word program memory
- ◆ Expanded system memory (6,000 internal bits; 2,000 registers)
- ◆ 145 instructions
- ◆ Fast execution time (0.75-2.25  $\mu$ s per basic instruction)

#### Special Features

- ◆ Many intelligent I/O modules
- ◆ Versatile communications (Host Link, PLC-to-PLC, Remote I/O)
- ◆ ASCII/BASIC module for co-processing/communications

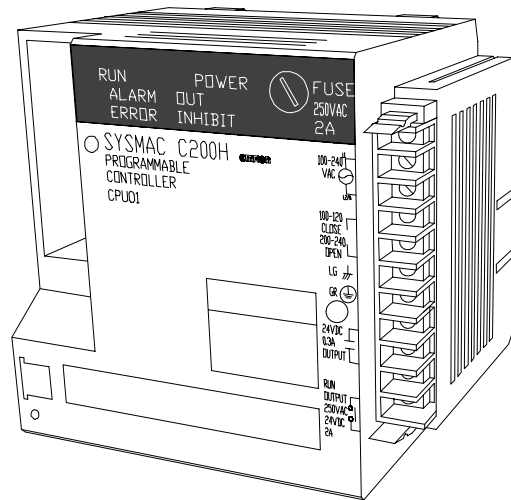

### C200H-CPU21-E/CPU23-E CPUs

#### High Spec, Small Rack Style

The C200H-CPU21-E and C200H-CPU23-E controllers offer increased I/O capacity and the same basic functionality as the OEM versions. In addition, these controllers offer an extended instruction set, clock/calendar option and larger power supplies. With new high-density I/O modules, these CPUs can be expanded to 720 local I/O.

#### Basic Configuration

*Same as CPU01, CPU03 plus the following:*

- ◆ Built-in 120 VAC (CPU21) or 24 VDC (CPU23) power supply
- ◆ Same configuration and I/O as CPU01/CPU03

#### CPU Features

*Same as CPU01, CPU03 plus the following:*

- ◆ Real-time clock/calendar option available
- ◆ Larger power supply (CPU21 only) for I/O modules
- ◆ Enhanced instruction set (168), including sine/cosine

#### Special Features

- ◆ 32- and 64-pt Group 2 High-density I/O modules

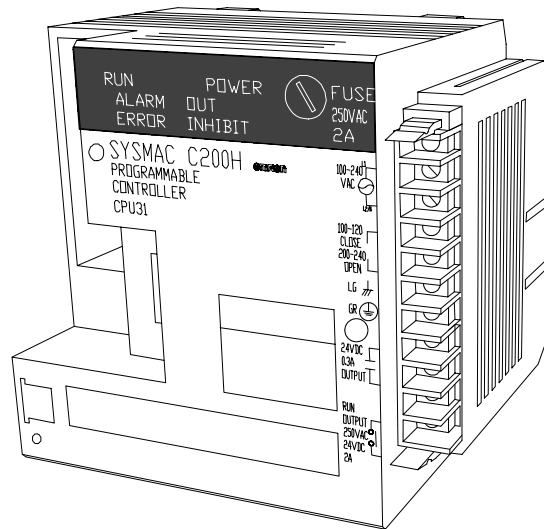

### C200H-CPU31-E CPU

#### High-Performance CIM Version

The C200H-CPU31-E controller offers a high-performance CPU especially designed for computer integrated manufacturing environments. The C200H-CPU31-E has all the capabilities of C200H CPU21/CPU23, with clock/calendar as a standard feature. This CPU is used in either SYSMAC NET and/or SYSMAC LINK communication systems.

#### Basic Configuration

*Same as CPU21, CPU23 plus the following:*

- ◆ Built-in 120 VAC power supply

#### CPU Features

*Same as CPU21, CPU23 plus the following:*

- ◆ Real-time clock/calendar

#### Special Features

*Same as CPU21, CPU23 plus the following:*

- ◆ SYSMAC LINK and SYSMAC NET capabilities. (Requires bus connector from module to PLC communications bus port.)

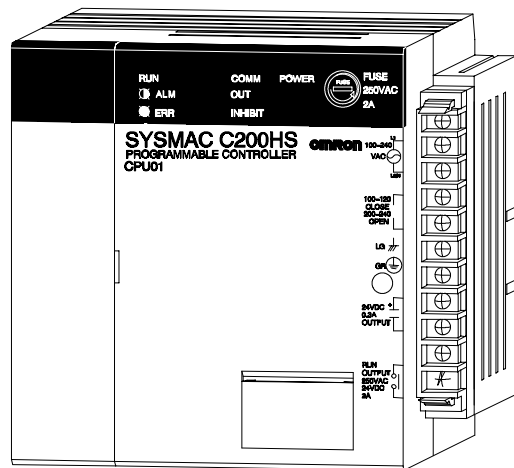

### C200HS-CPU01-E/CPU03-E CPUs

#### High Performance, Small Rack Style

The C200HS-CPU01-E and C200HS-CPU03-E controllers offer some of the same basic functionality as models C200H-CPU21-E/CPU23-E. These controllers have added capabilities ideally suited for high speed machine control, which includes larger memory, larger instruction set, and increased speed.

#### Basic Configuration

- ◆ Built-in 120 VAC (HS-CPU01) or 24 VDC (HS-CPU03) power supply
- ◆ Rack style PLC with 3-, 5-, 8-, 10- slot racks
- ◆ Accepts two local expansion racks
- ◆ Accepts remote I/O racks

#### CPU Features

- ◆ Built-in 16K ram (including 6144 READ/WRITE data memory bits)
- ◆ 0.375-1.313  $\mu$ s basic instruction execution time
- ◆ Built-in clock/calendar
- ◆ Enhanced instruction set (239), including PID and Scaling

#### Special Features

- ◆ 8-pt. Interrupt Input Module
- ◆ Group 2 High-density Modules

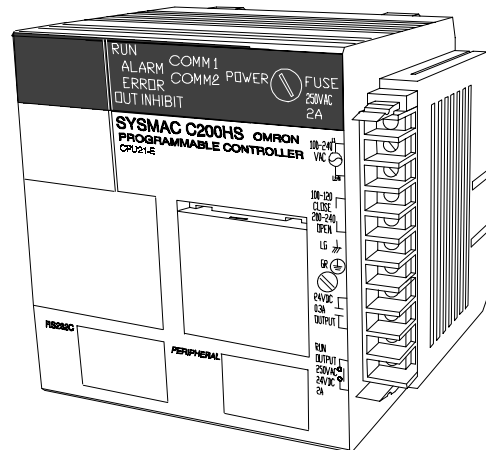

### C200HS-CPU21-E/CPU23-E CPUs

#### High Performance, Small Rack Style, Built-in RS-232C Port

The C200HS-CPU21-E and C200HS-CPU23-E controllers offer some of the same basic functionality as models C200H-CPU01-E/CPU03-E. These controllers have the added built-in RS-232C port. Host link communications are possible using the RS-232C port. By using the TXD and RXD instructions, less time consuming RS-232C communications is possible. NT link allows high-speed communications with a Programmable Terminal (PT).

#### Basic Configuration

*Same as HS-CPU01, HS-CPU03 plus the following:*

- ◆ Built-in 120 VAC (HS-CPU21) or 24 VDC (HS-CPU03) power supply
- ◆ Same configuration and I/O as HS-CPU01/HS-CPU03

#### CPU Features

*Same as HS-CPU01, HS-CPU03 plus the following:*

- ◆ Built-in RS-232C port



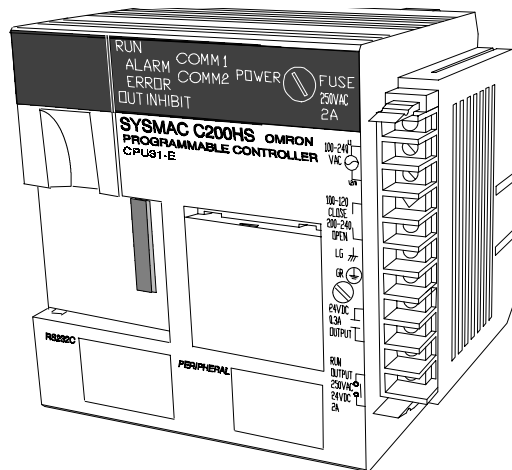

### C200HS-CPU31-E/CPU33-E CPUs

#### High-Performance CIM Version, Built-in RS-232C Port

The C200HS-CPU31-E and C200HS-CPU33-E controller offers the same basic functionality as the C200HS-CPU01-E/CPU03 controllers. This CPU may be used in either SYSMAC NET and/or SYSMAC LINK communication systems. The built-in RS-232C port supports the same communications as the C200HS-CPU21/CPU23.

#### Basic Configuration

*Same as HS-CPU01, HS-CPU03 plus the following:*

- ◆ Built-in 120 VAC (HS-CPU21) or 24 VDC (HS-CPU03) power supply
- ◆ Same configuration and I/O as HS-CPU01/HS-CPU03

#### CPU Features

*Same as HS-CPU01, HS-CPU03 plus the following:*

- ◆ Built-in RS-232C port

#### Special Features

*Same as HS-CPU01, HS-CPU03 plus the following:*

- ◆ SYSMAC LINK and SYSMAC NET capabilities. (Requires bus connector from module to PLC communications bus port.)

**C200H Comparison Table**

Item	C200H				
	CPU01-E	CPU03-E	CPU21-E	CPU23-E	CPU31-E
Group 2 High-density I/O Module compatibility C200H-ID216/ID217/OD218/OD219	No	No	Yes	Yes	Yes
Error history	No	No	Yes	Yes	Yes
Clock/calendar*	No	No	Yes	Yes	Yes
Forced Status Hold Bit (SR 25211)	No	No	Yes	Yes	Yes
TERMINAL mode for Programming Console	No	No	Yes	Yes	Yes
Optional instructions 1 (refer to Instruction Set Section): REVERSIBLE WORD SHIFT - RWS(17) SCAN TIME - SCAN(18) MULTI-WORD COMPARE - MCMP(19) LONG MESSAGE - LMSG(47) TERMINAL MODE - TERM(48) SET SYSTEM - SET(49) DOUBLE COMPARE - CMPL(60) COLUMN-TO-WORD - CTW(63) WORD-TO-COLUMN - WTC(64) HOURS-TO-SECONDS - HTS(65) SECONDS-TO-HOURS - STH(66) VALUE CALCULATE - VCAL(69) MULTIPOINT I/O REFRESH - MPRF(61)	No	No	Yes	Yes	Yes
Optional instructions 2 (refer to Instruction Set Section): PID CONTROL - PID(*) SCALING - SCL(*) TOTALIZING TIMER - TTIM(87) 2's COMPLEMENT - NEG(*) DOUBLE 2's COMPLEMENT - NEGL(*) FIND MINIMUM - MIN(*) FIND MAXIMUM - MAX(*) TENKEY INPUT - TKY(*) MATRIX INPUT - MTR(*) ASCII-to-HEX - HEX(*) AVERAGE - AVG(*) SUM - SUM(*) FAILURE POINT DETECT - FPD(*)	No	No	No	No	No
<b>Note</b> For complete list refer to instruction set section.					
SYSMAC NET, SYSMAC LINK network compatibility and instructions: NETWORK SEND - SEND(90) NETWORK RECEIVE - RECV(98)	No	No	No	No	Yes
Power supply	AC	DC	AC	DC	AC
Internal logic current capacity (for I/O modules)	1.6 A	1.6 A	3.2 A	1.6 A	3.0 A

\*A clock is built into the C200H-CPU31-E; the C200H-CPU21-E and C200H-CPU23-E can use the clock built into some of the Memory Packs. (Refer to Standard Parts.)

1

## C200HS Comparison Table

Item	C200HS					
	CPU01-E	CPU03-E	CPU21-E	CPU23-E	CPU31-E	CPU33-E
Group 2 High-density I/O Module compatibility C200H-ID216/ID217/OD218/OD219	Yes	Yes	Yes	Yes	Yes	Yes
Error history	Yes	Yes	Yes	Yes	Yes	Yes
Clock/calendar*	Yes	Yes	Yes	Yes	Yes	Yes
Forced Status Hold Bit (SR 25211)	Yes	Yes	Yes	Yes	Yes	Yes
TERMINAL mode for Programming Console	Yes	Yes	Yes	Yes	Yes	Yes
Optional instructions 1 (refer to Instruction Set Section): REVERSIBLE WORD SHIFT - RWS(17) SCAN TIME - SCAN(18) MULTI-WORD COMPARE - MCMP(19) LONG MESSAGE - LMSG(47) TERMINAL MODE - TERM(48) SET SYSTEM - SET(49) DOUBLE COMPARE - CMPL(60) COLUMN-TO-WORD - CTW(63) WORD-TO-COLUMN - WTC(64) HOURS-TO-SECONDS - HTS(65) SECONDS-TO-HOURS - STH(66) VALUE CALCULATE - VCAL(69) MULTIPOINT I/O REFRESH - MPRF(61)	Yes	Yes	Yes	Yes	Yes	Yes
Optional instructions 2 (refer to Instruction Set Section): PID CONTROL - PID(*) SCALING - SCL(*) TOTALIZING TIMER - TTIM(87) 2's COMPLEMENT - NEG(*) DOUBLE 2's COMPLEMENT - NEGL(*) FIND MINIMUM - MIN(*) FIND MAXIMUM - MAX(*) TENKEY INPUT - TKY(*) MATRIX INPUT - MTR(*) ASCII-to-HEX - HEX(*) AVERAGE - AVG(*) SUM - SUM(*) FAILURE POINT DETECT - FPD(*) <b>Note</b> For complete list refer to instruction set section.	Yes	Yes	Yes	Yes	Yes	Yes
SYSMAC NET, SYSMAC LINK network compatibility and instructions: NETWORK SEND - SEND(90) NETWORK RECEIVE - RECV(98)	No	No	No	No	Yes	Yes
Power supply	AC	DC	AC	DC	AC	DC
Internal logic current capacity (for I/O modules)	3.9 A	2.3 A	3.9 A	2.3 A	3.9 A	2.3 A
Built-In RS232C PORT	No	No	Yes	Yes	Yes	Yes

\*A clock is built into the C200H-CPU31-E; the C200H-CPU21-E and C200H-CPU23-E can use the clock built into some of the Memory Packs. (Refer to Standard Parts.)

**C200H Specifications**

Part number	C200H-CPU01-E/CPU03-E	C200H-CPU21-E/CPU23-E	C200H-CPU31-E
<b>Main Control Element</b>	MPU, CMOS, LS-TTL		
<b>Programming languages</b>	Ladder diagram		
<b>Instruction set</b>	145 (12 basic instructions + 133 special instructions)	168 (12 basic instructions + 156 special instructions)	172 (12 basic instructions + 160 special instructions)
<b>Instruction length</b>	1 to 4 words/instruction, 1 address/instruction		
<b>Execution time</b>	0.75 to 2.25 $\mu$ s (basic instructions) 34 to 724 $\mu$ s (function no. instructions)		
<b>I/O control method</b>	Cyclic, programmed, scheduled, and zero-cross refreshing		
<b>Control input signal</b>	START INPUT (in RUN mode, PLC operates when contacts are closed and stops when contacts are opened; 24 VDC, 10 mA)		
<b>Control output signal</b>	RUN OUTPUT; dry contact (contacts are closed while PLC is in RUN mode; maximum switching capacity: 2 A, 250 VAC (resistive load, p.f. = 1), 0.5 A, 250 VAC (inductive load, p.f. = 0.4), 2 A, 24 VDC)		
<b>Memory protection</b>	Status of HR bits, AR bits, preset value of counters (CNT), and contents of data memory (DM) are retained during power failure. RAM Pack, battery back-up: Program (including clock function) and data areas protected. RAM Pack, capacitor back-up: Program and data areas protected. EEPROM Pack (without clock function): Data areas protected. EEPROM Pack (with clock function): Clock function and data areas protected. C200H-CPU31-E: Program and data areas (including clock function) protected.		
<b>Battery life</b>	4 years at 25°C (77°F); shortened at temperatures higher than 25°C. Replace battery with new one within 1 week when ALARM indicator blinks.		
<b>Self-diagnostics</b>	Errors for CPU failure, Battery, Scan time, Memory failure, I/O bus, I/O verify, Remote I/O, Link error, Special I/O Modules, CPU Bus Modules		
<b>Agency approvals</b>	UL listed, file number: E95399 CSA certified, file number: LR51460		

**Memory**

<b>Memory capacity</b>	6,974 words (with 8K-word memory)		
<b>Internal relay (IR) bits</b>	Standard I/O Modules: 480 (00000 through 02915)		
	I/O Modules mounted to Remote Expansion Racks and Special I/O Modules 3,296 (03000 through 23515)	I/O Modules mounted to Remote Expansion Racks and Special I/O Modules 3,296 (03000 through 23515) Group 2 High-density I/O Modules 320 (03000 through 04915)	
<b>Special Relay (SR) bits</b>	312 (23600 through 25507)		
<b>Temporary relay (TR) bits</b>	8 (TR 0 through 7)		
<b>Holding relay (HR) bits</b>	1,600 (HR 0000 through 9915)		
<b>Auxiliary relay (AR) bits</b>	448 (AR 0000 through 2715)		
<b>Latching relay (LR) bits</b>	1,024 (LR 0000 through 6315)		
<b>Timers/Counters</b>	512 (TIM/CNT 000 through 511) TIMs: 0 through 999.9 s TIMHs: 0 through 99.99 s CNT: 0 through 9999 counts		

## C200HS Specifications

Part number	C200HS-CPU01-E/CPU03-E	C200HS-CPU21-E/CPU23-E	C200HS-CPU31-E CPU33-E
<b>Main Control Element</b>	MPU, CMOS, LS-TTL		
<b>Programming languages</b>	Ladder diagram		
<b>Instruction set</b>	239 (14 basic instructions + 225 special instructions)	239 (14 basic instructions + 225 special instructions)	243 (14 basic instructions + 299 special instructions)
<b>Instruction length</b>	1 to 4 words/instruction, 1 address/instruction		
<b>Execution time</b>	0.375-1.313 $\mu$ s (basic instructions)		
<b>I/O control method</b>	Cyclic, programmed, scheduled, and zero-cross refreshing		
<b>Control input signal</b>	START INPUT (in RUN mode, PLC operates when contacts are closed and stops when contacts are opened; 24 VDC, 10 mA)		
<b>Control output signal</b>	RUN OUTPUT: dry contact (contacts are closed while PLC is in RUN mode; maximum switching capacity: 2 A, 250 VAC (resistive load, p.f. = 1), 0.5 A, 250 VAC (inductive load, p.f. = 0.4), 2 A, 24 VDC)		
<b>Memory protection</b>	Status of HR bits, AR bits, preset value of counters (CNT), and contents of data memory (DM) are retained during power failure. RAM Pack, battery back-up: Program (including clock function) and data areas protected. RAM Pack, capacitor back-up: Program and data areas protected. EEPROM Pack (without clock function): Data areas protected. EEPROM Pack (with clock function): Clock function and data areas protected. C200H-CPU31-E: Program and data areas (including clock function) protected.		
<b>Battery life</b>	4 years at 25°C (77°F); shortened at temperatures higher than 25°C. Replace battery with new one within 1 week when ALARM indicator blinks.		
<b>Self-diagnostics</b>	Errors for CPU failure, Battery, Scan time, Memory failure, I/O bus, I/O verify, Remote I/O, Link error, Special I/O Modules, CPU Bus Modules		
<b>Agency approvals</b>	UL listed, file number: E95399 CSA certified, file number: LR51460		

## Memory

<b>Memory capacity</b>	15.2k words (with 16k word memory)
<b>Internal relay (IR) bits</b>	Standard I/O Modules: 480 (00000 through 02915)  I/O Modules mounted to Remote Expansion Racks and Special I/O Modules 6688 (03000 through 23515, 30000-51115) Group 2 High-density I/O Modules 320 (03000 through 04915)
<b>Special Relay (SR) bits</b>	1016 (23600 through 25507 and 25600 through 29915)
<b>Temporary relay (TR) bits</b>	8 (TR 0 through 7)
<b>Holding relay (HR) bits</b>	1,600 (HR 0000 through 9915)
<b>Auxiliary relay (AR) bits</b>	448 (AR 0000 through 2715)
<b>Latching relay (LR) bits</b>	1,024 (LR 0000 through 6315)
<b>Timers/Counters</b>	512 (TIM/CNT 000 through 511) TIMs: 0 through 999.9 s TIMHs: 0 through 99.99 s CNT: 0 through 9999 counts

1

**C200H/C200HS Specifications**

Part number	C200H-CPU01-E/CPU03-E	C200H-CPU21-E/CPU23-E	C200H-CPU31-E	C200HS-CPU01-E/CPU03-E C200HS-CPU21-E/CPU23-E C200HS-CPU31-E/CPU33-E
<b>Data memory (DM) words</b>	Read/write: 1,000 (DM 0000 through 0999) Read only: 1,000 (DM 1000 through 1999) DM area as in Memory Park.			Read/Write: 6144 (DM0000 through 6143) Read only: 512 (6144 through 6655) 3000 Word max. (DM7000 through 9999)
<b>Program check</b>	Program check (executed on start of RUN operation): END missing, Instruction errors, (Program can be checked by Programming Console, GPC, or LSS at three levels.)			

**Power Supply Specifications**

Part number	C200H-CPU01-E/CPU21-E/CPU31-E, C200HS-CPU01-E, C200HS-CPU21-E, C200HS-CPU31-E, C200H-PS221	C200H-CPU23-E, C200HS-CPU03-E, C200HS-CPU23-E, C200HS-CPU33-E, C200H-PS211
<b>Supply voltage</b>	100 to 120/200 to 240 VAC selectable, 50/60 Hz	24 VDC
<b>Operating voltage range</b>	85 to 132/170 to 264 VAC	20.4 to 26.4 VDC
<b>Power consumption</b>	100 VA max.	50 W max.
<b>Surge current</b>	30 A max.	30 A max.
<b>Output capacity</b>	CPU01-E: 3 A, 5 VDC (1.6 A supplied to I/O Modules) CPU-21-E: 4.6 A, 5 VDC (3.2 A supplied to I/O Modules) CPU-31-E: 4.6 A, 5 VDC (3.0 A supplied to I/O Modules) HS-CPU01-E, HS-CPU21-E, HS-CPU31-E 4.6 A, 5 VDC (3.9 A supplied to I/O Modules) Expansion I/O Rack: 3 A, 5 VDC (2.7 A supplied to I/O Modules)	CPU03-E: 3 A, 5 VDC (1.6 A supplied to I/O Modules) CPU-23-E: 3 A, 5 VDC (1.6 A supplied to I/O Modules) HS-CPU03-E, HS-CPU23-E, HS-CPU33-E: 3 A, 5 VDC (2.3 A supplied to I/O Modules) Expansion I/O Rack: 3 A, 5 VDC (2.7 A supplied to I/O Modules)
<b>Fuse</b>	2 A, 250 V, 5.2 dia. x 20 (MF51NR)	2 A, 125 V, 5.2 dia. x 20 (MF51NR)
<b>Input power supply</b>	0.3 A, 24 VDC +10%/-20%	—
<b>Insulation resistance*</b>	20 MΩ between AC terminals and the GR terminal at 500 VDC	
<b>Dielectric strength*</b>	2,000 VAC, 50/60 Hz for 1 minute between AC terminals and housing 500 VAC, 50/60 Hz for 1 minute between DC terminals and housing. Leakage current: 10 mA max.	
<b>Noise immunity</b>	1,500 Vp-p, pulse width: 100 ns to 1 ms, rise time: 1 ns (by noise simulator)	
<b>Vibration**</b>	Mechanical durability: 10 to 35 Hz, 1 mm double amplitude (2.5 G) in X, Y, and Z directions, for 2 hours each (When mounted on DIN track, 16.7 Hz, 1 mm double amplitude (0.5 G) in X, Y, and Z directions, for 1 hour each) Malfunction durability: 2 to 55 Hz, 2 G, in X, Y, and Z directions, for 20 minutes each (When mounted on DIN track, 2 to 55 Hz, 0.3 G, in X, Y, and Z directions, for 20 minutes each)	
<b>Shock</b>	10 G in X, Y, and Z directions, 3 times each	
<b>Ambient temperature</b>	Operating: 0° to 55°C (0° to 45°C for Programming Console) Storage: -20° to 65°C	
<b>Humidity</b>	35% to 85% (without condensation)	
<b>Atmosphere</b>	Must be free of the following: Corrosive gases; Abrupt temperature changes; Direct sunlight; Dust, salt, or metal filings; Water, oil, or chemicals	
<b>Grounding</b>	Less than 100 Ω	
<b>Enclosure rating</b>	IEC IP30 (mounted in a panel)	

**Note** \*Disconnect the LG terminal of the Power Supply Module from the GR terminal when performing insulation and dielectric strength tests. If the tests are performed with the LG and GR terminals short-circuited, the internal components will be damaged. Do not conduct a dielectric strength test on the C200H-CPU03-E, C200H-CPU23-E, C200H-PS211, C200H-RT002-P, or C200H-RT202 modules. The power supply input line and internal circuit of the 24 VDC power supply are not isolated from each other. If a dielectric strength test is conducted, the power supply will be damaged.

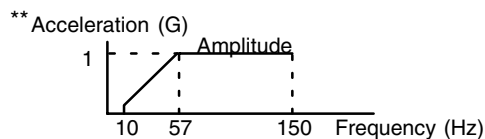

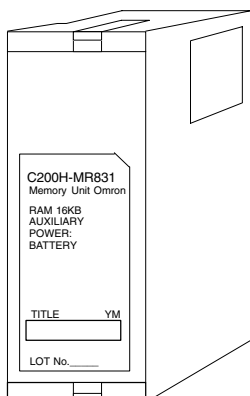

### General Information

Memory Packs store programs and data for C200H controllers. Select 4 or 8 K word memory packs to match your requirements. To take advantage of the clock/calender option for C200H-CPU21 and -CPU23, select a memory pack with clock. Increase the C200HS built-in RAM with an additional 16 K words of file memory for large processing loads.

### Features

- ◆ Three types available: EPROM, EEPROM, RAM
- ◆ Optional clock and calender for C200H-CPU21/CPU23
- ◆ File memory boards available for C200HS-CPU01/CPU03
- ◆ C200HS has built-in RAM memory



Name	Description	Part number
<b>Required Parts</b>		
Memory Packs (Not required for C200HS)	RAM, 4 K words, battery back-up; no clock	<b>C200H-MR431</b>
	RAM, 8 K words, battery back-up; no clock	<b>C200H-MR831</b>
	RAM, 4 K words, capacitor back-up; no clock	<b>C200H-MR432</b>
	RAM, 8 K words, capacitor back-up; no clock	<b>C200H-MR832</b>
	RAM, 4 K words, battery back-up; with clock (CPU21, CPU23 only)	<b>C200H-MR433</b>
	RAM, 8 K words, battery back-up; with clock (CPU21, CPU23 only)	<b>C200H-MR833</b>
	EPROM, 8 K words, no clock	<b>C200H-MP831</b>
	EEPROM, 4 K words, no clock	<b>C200H-ME431</b>
	EEPROM, 8 K words, no clock	<b>C200H-ME831</b>
	EEPROM, 4 K words, battery back-up; with clock (CPU21, CPU23 only)	<b>C200H-ME432</b>
	EEPROM, 8 K words, battery back-up; with clock (CPU21, CPU23 only)	<b>C200H-ME832</b>
<b>Optional Parts</b>		
File Memory Boards (C200HS only)	EPROM, 16 K words	<b>C200HS-MP16K</b>
	EEPROM, 16 K words	<b>C200HS-ME16K</b>

1



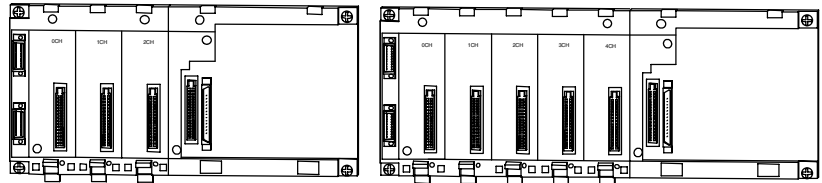

C200H-BC031-V2

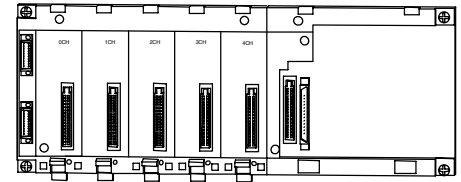

C200H-BC051-V2

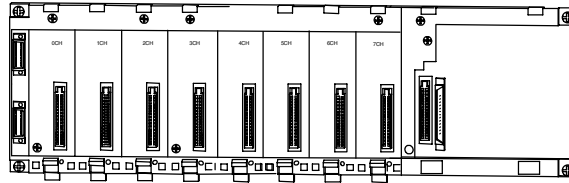

C200H-BC081-V2

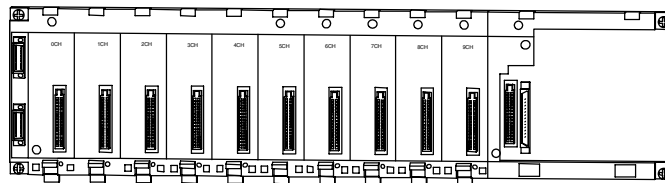

C200H-BC101-V2

### C200H Backplanes

These C200H Backplanes are used for CPU Racks, Local, and Remote Expansion Racks. They are available with 3, 5, 8, and 10 I/O slots. The power supplies for these racks are built into the SYSMAC BUS Remote Slave Modules. The CPU, Power Supply (for Local Expansion Racks), or SYSMAC BUS Remote Slave/Power Supply mounts in the right-most slot of the Rack.

Number of slots	Part number
3 slots	C200H-BC031-V2
5 slots	C200H-BC051-V2
8 slots	C200H-BC081-V2
10 slots	C200H-BC101-V2

**Two RS-232C ports**

Bidirectional serial interface to

- Computers
- Printers
- Bar code readers
- PLCs
- Other ASCII devices

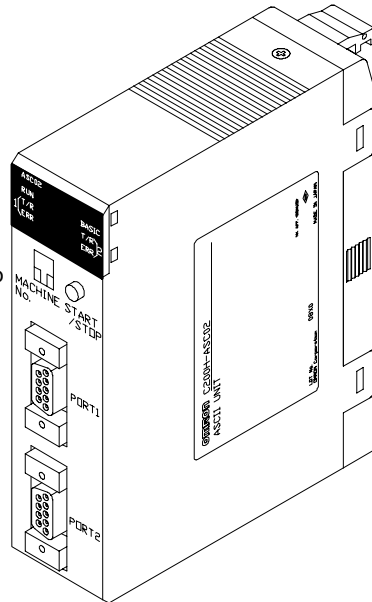

C200H-ASC02

**General Information**

The ASCII/BASIC Module provides a 24-Kbyte programmable coprocessor module that operates independently of the PLC. Two built-in RS-232C ports provide easy interface to a variety of external devices including other manufacturers' PLCs, computer terminals, operator stations, bar code readers, and any other device utilizing a serial interface. The module is programmable in either BASIC or Assembly providing a platform for complex calculations and algorithms at the PLC level. This includes PID, gas flow calculations and complex math and string manipulation functions. Communications can be initiated by either the module or the PLC.

**Features**

- ◆ 24-Kb, battery-backed RAM and 24-Kb EEPROM programmable in BASIC or Assembly languages
- ◆ Special commands to initiate communication with the PLC
- ◆ Two RS-232C ports, 19,200 baud maximum speed
- ◆ Built-in clock/calendar including year, month, day, date, hour, minute, second (accurate to 30 seconds/year)

**Specifications**

Name	Description	Part number
ASCII/BASIC Module Utility Software	For AT-compatible computers; enables program development, downloading, uploading, etc.	SYSMATE-ASC91-V1
Programming Cable	C200H-ASC02 to computer (9-pin RS-232)	C200H-CN229-EU
	C200H-ASC02 to computer (25-pin RS-232)	C200H-CN220-EU

**Specifications**

<b>Part number</b>	<b>C200H-ASC02</b>
<b>Communication mode</b>	Half duplex
<b>Synchronization</b>	Start-stop
<b>Baud rate</b>	Port 1: 300/600/1200/2400/4800/9600 bps Port 2: 300/600/1200/2400/4800/9600/19,200 bps (switch selectable)
<b>Transmission mode</b>	Point-to-point
<b>Transmission distance</b>	15 m (49 ft) max.
<b>Interface</b>	Conforms to RS-232C. Two ports (D-sub 9-pin connectors)
<b>Memory capacity</b>	24 Kbytes RAM battery backup 24 Kbytes EEPROM for program storage Multiple program storage capability
<b>Transfer capacity</b>	255 words at a maximum of 20 words per scan
<b>Transfer method</b>	Write/read data exchange I/O data exchange
<b>Clock/calendar</b>	Year, month, day, date, hour, minute, second Programmable leap year Accuracy: month +30 seconds/month at 25°C (77°F)
<b>Diagnostic functions</b>	CPU watchdog timer, battery voltage drop
<b>Battery life</b>	5 years at 25°C (77°F). Battery life is shortened if ASCII Module is used at higher temperatures.
<b>EEPROM</b>	Guaranteed lifetime of 5000 saves
<b>Manual</b>	PLC Module: W165 The manual is included with the software.

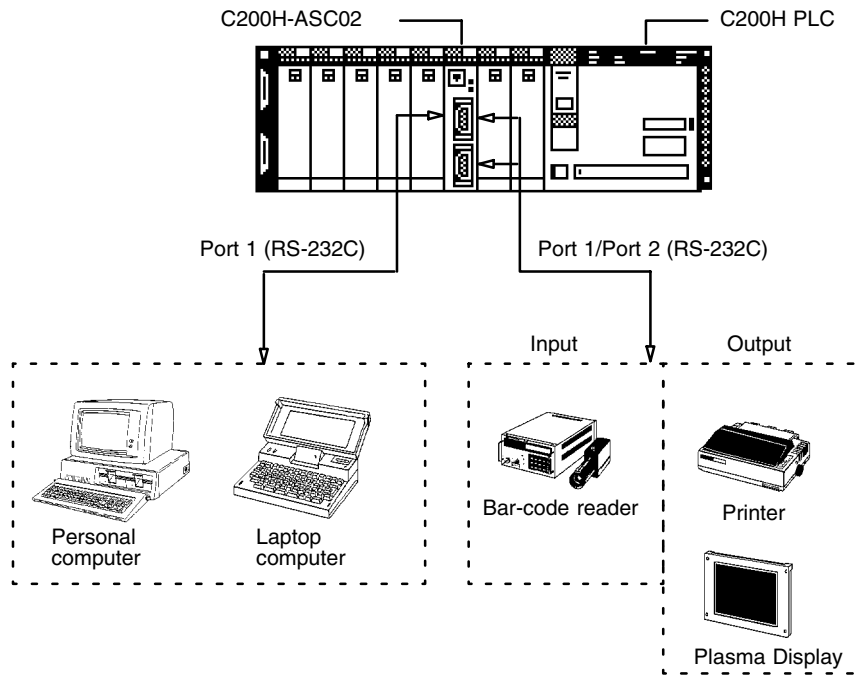

1

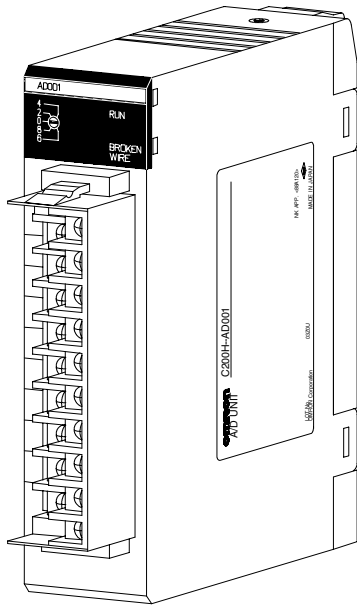

C200H-AD001

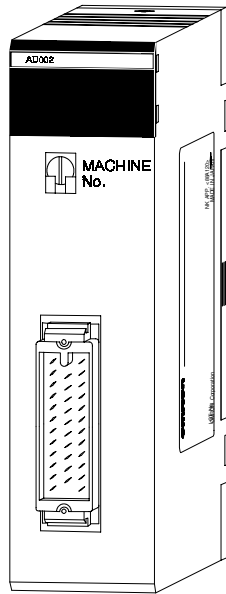

C200H-AD002

### General Information

Analog I/O Modules provide an interface to a variety of analog signals including both voltage and current ranges. Both input and output versions are available in a variety of densities.

### Features

- ◆ Cost-effective single-slot modules available with 4 or 8 analog inputs
- ◆ Opto-isolated input reliability
- ◆ 12-bit resolution
- ◆ Selectable ranges include 1 to 5 V, 0 to 10 V, and 4 to 20 mA

### Specifications

Part number	C200H-AD001	C200H-AD002
Number of points	4	8
Signal ranges	Voltage	1-5 VDC or 0-10 VDC
	Current	4-20 mA
Intelligent functions	Input conversion	Input conversion, scaling, average, Peak hold, BCD, Upper and Lower limit alarm
Resolution	12-bit	12-bit
Accuracy	±1.0% maximum full scale, at 0°C -55°C ±0.1% maximum linearity error	±0.6% maximum full scale, at 0°C -55°C, for voltage input ±0.1% maximum linearity error
A/D conversion time	2.5 ms maximum/point	2.5 ms maximum/point
Input impedance	Voltage	1 MΩ minimum
	Current	250Ω
Manual	W127	W229

### Typical Application

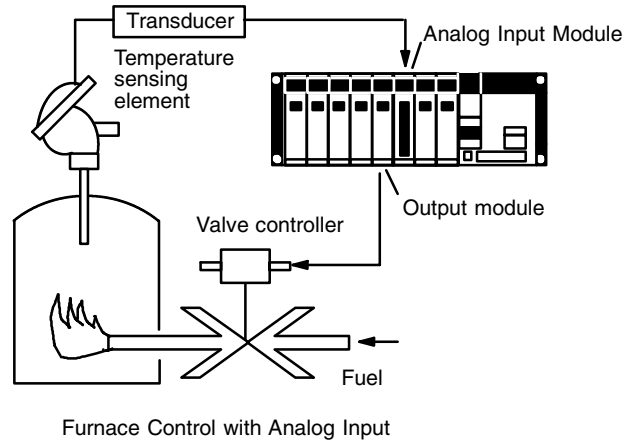

1

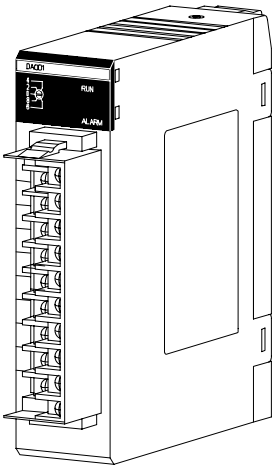

C200H-DA001

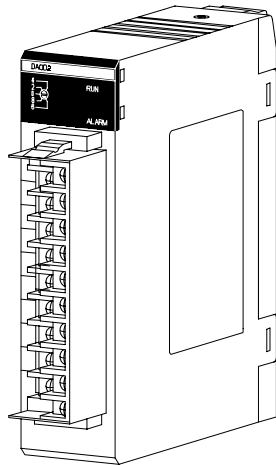

C200H-DA002

**General Information**

Analog I/O Module provides an interface to a variety of analog devices that accept voltage and current ranges.

**Features**

- ◆ Cost-effective single-slot module offers two or four analog outputs
- ◆ Selectable ranges include 1 to 5 V, 0 to 10 V, -10 to +10 V, and 4 to 20 mA

**Specifications**

Part number	C200H-DA001		C200H-DA002
Number of output points	2		4
Signal ranges	Voltage	1 to 5 V, 0 to 10 V	-10 to +10 V
	Current	4 to 20 mA	4 to 20 mA
Intelligent functions	Output limit, upper and lower limit alarms, pulse output		-
Resolution	Voltage	12-bit	13-bit
	Current	12-bit	12-bit
Accuracy	±1.0% maximum full scale, at 0°C -55°C		±1.0% maximum full scale, at 0°C -55°C
A/D conversion time	2.5 ms maximum/point		2.5 ms maximum/point
Input impedance	Max. Load	400 Ω	350 Ω
	Max. Load Current	15 mA	10 mA
Manual	W127		W260

### Typical Application

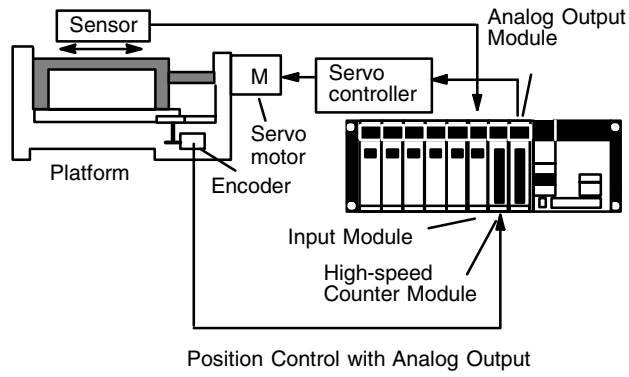

1

# High-speed Counter Modules

C200H-CT001-V1,  
C200H-CT002

# Special I/O Modules

## General Information

The high-speed counter modules provide an interface for applications where the counting speed exceeds the PLC's processing speed. Typical applications include frequency inputs, rotary encoder interface, position control, cut to length, and motion control. Built-in I/O and front panel indicators on the module allow for faster throughput and easy visual monitoring of module status. Interface signals include count inputs, integral outputs, and external resets.

## Features

- ◆ Three types of input to enable a wide variety of encoder/sensor compatibility
- ◆ Can be operated in any one of six modes
- ◆ Set values can be changed during operation
- ◆ Mode selection made through front panel DIP switches
- ◆ Up to eight external outputs

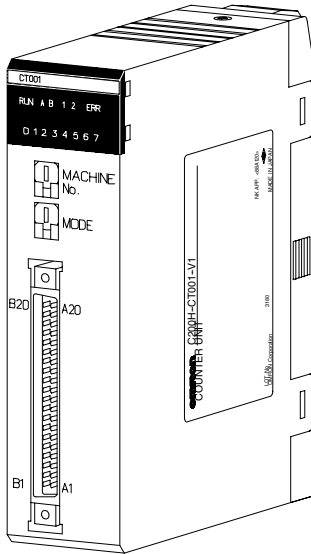

C200H-CT001-V1

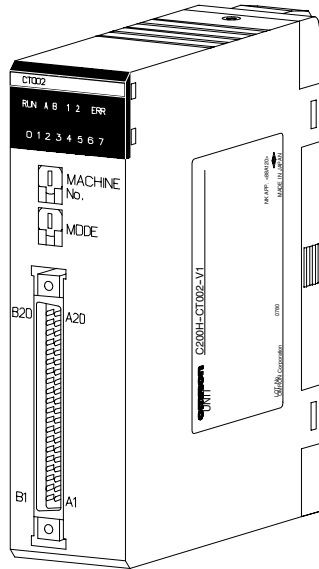

C200H-CT002

## Specifications

Part number	C200H-CT001-V1	C200H-CT002
Number of axes	One per module	
Operating modes	Any of the following six: Linear Preset Latch Circular Gate Sampling	
Count input mode	Differential, phase, up/down, pulse/direction	
Count signal level	5, 12, or 24 VDC (wired for one)	Same as RS-422 line driver (Am26LS31-compatible)
Counting speed	50 kHz max. (depends on encoder when using offset phase inputs)	75 kHz max. (depends on encoder when using offset phase inputs)
Input multiplier	x2, x4 available for offset phase input	
Input signals	Input Z Control input 1 Control input 2	
External outputs	8 total	
I/O (points) required	64 (4 words)	
Manual	W141	



### Typical Application

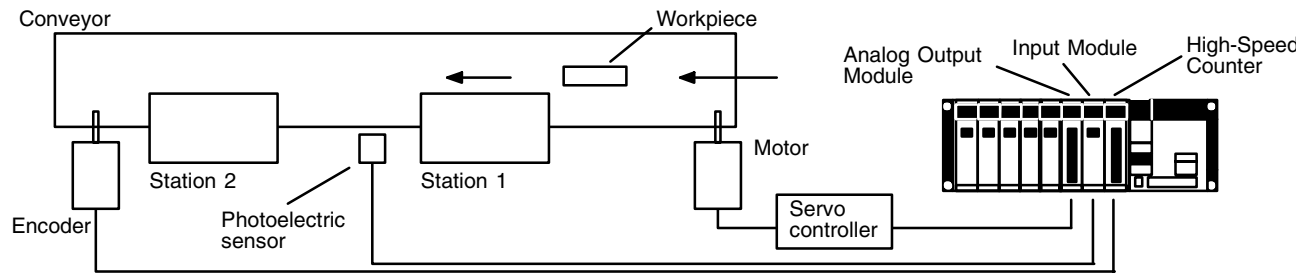

### Accessories

Description	Part number
Encoder Adapter	3G2A5-AE001

1

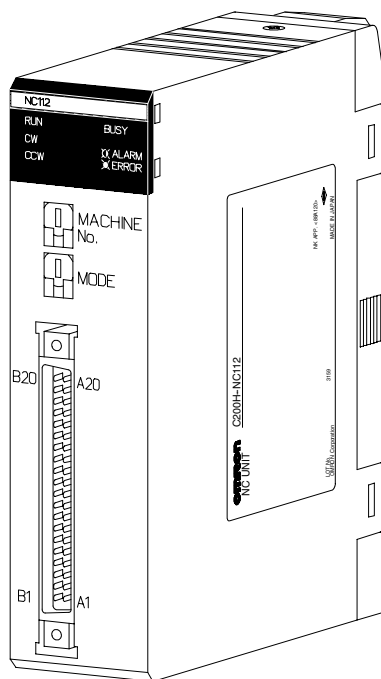

C200H-NC112

## General Information

Position control modules provide either a step and direction pulse train or CW/CCW pulse trains to control a single-axis stepper or servo motor driver. Interface signals include CW and CCW limits, origin approach, origin stop, emergency stop, and interrupt signals. Automatic backlash and origin offset functions are now included for precise positioning requirements. Move parameters can be set up in either ladder logic, or by connecting the hand-held programming console, and are stored in battery-backed memory. Extensive diagnostics are also available to the PLC for quick error detection and troubleshooting.

## Features

- ◆ Pulse output for stepper motor or servo motor driver
- ◆ Origin and backlash compensation for precision positioning
- ◆ Teach mode or storage of calculated movement parameters
- ◆ Internal diagnostics
- ◆ External signal interface for CW, CCW, origin, emergency stop, mode, and interrupt
- ◆ Parameters, speeds, and positions set in CPU DM area

## Specifications

<b>Part number</b>	<b>C200H-NC112</b>	
<b>Number of axes</b>	One axis per module	
<b>Control system</b>	Automatic trapezoidal acceleration/deceleration	
<b>Position</b>	<b>Data points</b>	53
	<b>Range</b>	-8,388,607 to +8,388,606 pulses
<b>Speed</b>	<b>Data points</b>	15
	<b>Range</b>	1 to 250,000 pulses per second
<b>Speed adjustment rate</b>	2 to 2,000 pps/s	
<b>Origin search</b>	<b>Origin proximity</b>	Selectable; absent, Normally Open, Normally Closed
	<b>Origin signal</b>	Selectable; Normally Open or Normally Closed input
	<b>Origin compensation</b>	0 to 9,999 pulses
	<b>Origin search speed</b>	High speed and proximity speed available
<b>Backlash compensation</b>	0 to 9,999 pulses	
<b>Manual operations</b>	High-speed jog, low-speed jog, inching	
<b>Manual</b>	W128	

### Typical Application

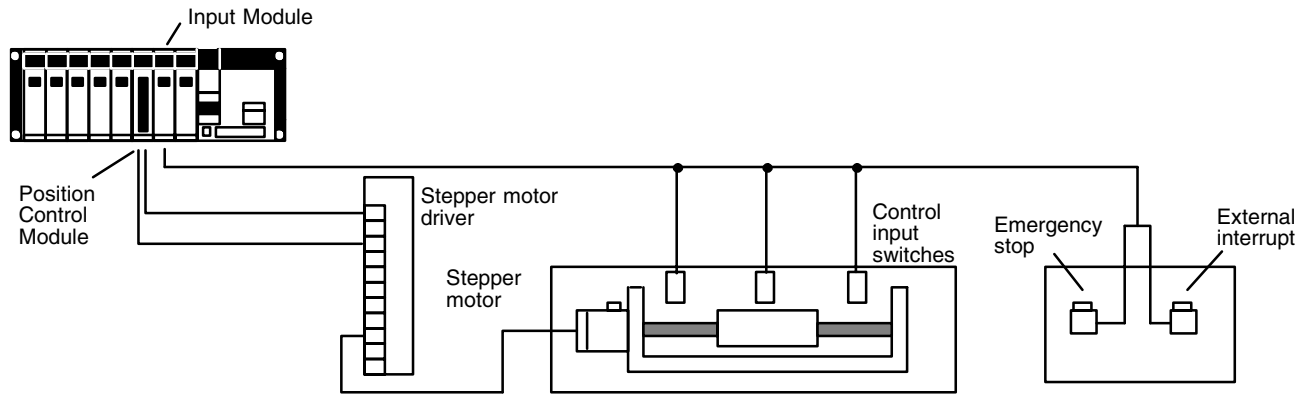

1

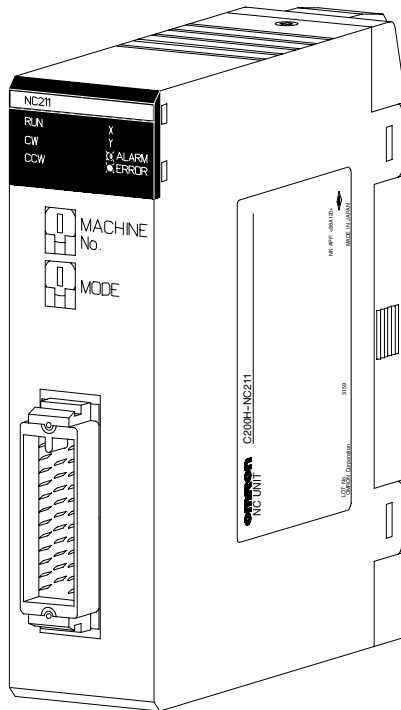

C200H-NC211

**General Information**

The two-axis position control module provides signals to control two servo motor drivers either independently or simultaneously. Interface signals include CW and CCW, origin approach, origin, stop, emergency stop, and interrupt signals. Automatic backlash and origin correction functions are now included for precise positioning requirements. Move parameters can be set up in either ladder logic, or by connecting the hand-held Programming Console, and are stored in battery-backed memory. Extensive diagnostics are available through the PLC for quick error detection and troubleshooting.

**Features**

- ◆ 2 axes of control
- ◆ Provides independent or simultaneous axis control
- ◆ Origin and backlash compensation
- ◆ Teach mode and external display for fast and efficient programming and diagnostic functions
- ◆ Linear interpolation capability

**Specifications**

<b>Part number</b>	<b>C200H-NC211</b>	
<b>Number of axes</b>	Two axes per module	
<b>Control system</b>	Automatic trapezoidal acceleration/deceleration	
<b>Position</b>	<b>Data points</b>	53 per axis
	<b>Range</b>	-8,388,607 to +8,388,606 pulses
<b>Speed</b>	<b>Data points</b>	15
	<b>Range</b>	1 to 250,000 pulses per second
<b>Acceleration/deceleration</b>	2 to 2,000 pps/1 ms	
<b>Origin search</b>	<b>Origin proximity</b>	Selectable; absent, Normally Open input, Normally Closed input
<b>Origin search</b>	<b>Origin signal</b>	Selectable; Normally Open or Normally Closed input
	<b>Origin compensation</b>	0 to +9,999 pulses
	<b>Origin search speed</b>	Selectable; high speed and proximity speed available Stop at origin signal after proximity signal has turned ON Stop at origin signal after proximity signal has turned OFF
<b>Backlash compensation</b>	0 to 9,999 pulses	
<b>Manual operations</b>	High-speed jog, low-speed jog, inch	
<b>Manual</b>	W166	

1

### Typical Application

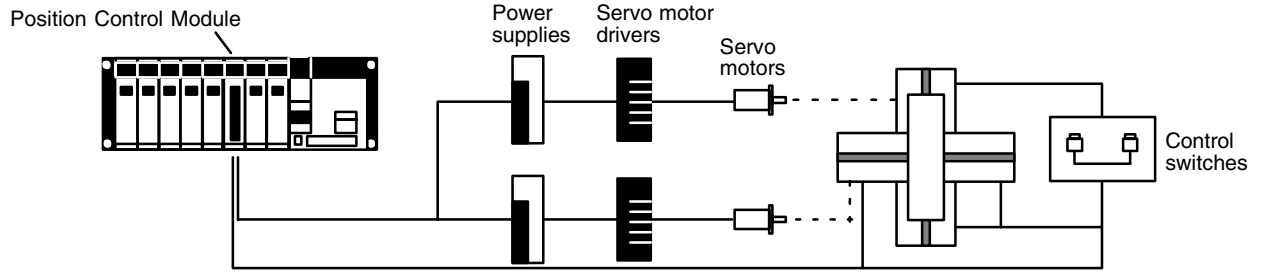

## Temperature Sensor Input Modules

C200H-TS001,  
C200H-TS101

# Special I/O Modules

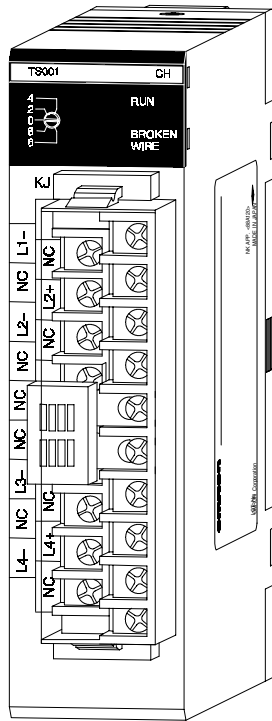

C200H-TS001

### General Information

Monitor up to 4 temperature inputs directly from the PLC rack. Choose thermocouple inputs (types J and K), or platinum RTD inputs. Each module offers multiple ranges and a choice of Fahrenheit or Celsius scaling.

### Features

- ◆ Available for thermocouple types J and K, or platinum RTD temperature sensors
- ◆ Selectable number of inputs
- ◆ Wide range of temperature settings

### Specifications

Part number	C200H-TS001	CS200H-TS101
Sensing element	Thermocouple: Type K or J selectable	Platinum RTD: Pt = 100 Ω
External input points	4 points max. per module (1, 2, or 4 points selectable)	
Output code to PLC	4-digit BCD	
Accuracy	±(1% Full scale + 1°C) max.	
Conversion time	1.2 sec max. per point	
Conversion cycle	4.8 sec max. at 4 points per module 2.4 sec max. at 2 points per module 1.2 sec max. at 1 point per module	
PLC booting time	Conversion cycle + 1 PLC scan time	
Terminal connections	Terminal block (removable)	
Insulation mode	Non-insulated between terminals. Insulated by photocoupler between terminal block and PLC backplane.	
Diagnostics	Outside range, broken wire, temperature setting error	
Manual	W124	

### Typical Application

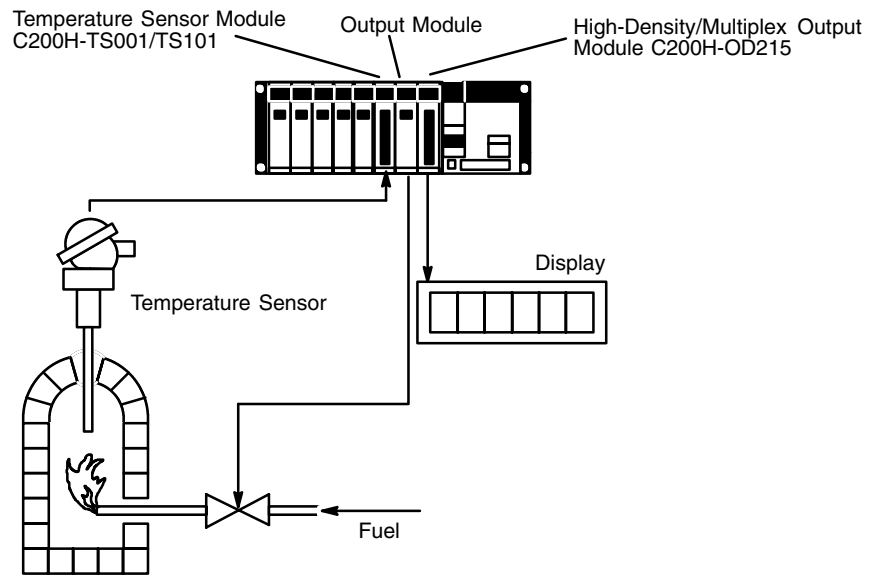

1

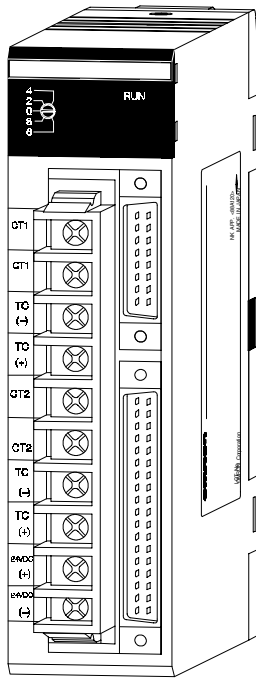

C200H-TC0\_ \_

## General Information

Omron has put two X-Series Temperature Controllers in a single slot module to provide advanced PID control with auto-tuning directly on the PLC rack. Display and set parameters with the C200H-DSC01 Data Setting Console.

## Features

- ◆ Auto-tuning of PID constants
- ◆ Eight banks of settings data
- ◆ Heater burnout detection
- ◆ Ten alarm modes
- ◆ Thermocouple or RTD inputs
- ◆ Transistor, current or voltage outputs
- ◆ Optional data setting console

## Specifications

Part numbers	C200H-TC0_ _	C200H-TC1_ _
Inputs	2 (two independent control loops)	
Temperature sensor inputs	Thermocouple (R, S, K, J, T, E, B, N, L, V)	RTD (JPt 100, Pt 100)
Control mode	PID, ON/OFF (Advanced PID with auto-tuning)	
Setting indication accuracy	$\pm 0.5\%$ of set/indication value or $\pm 2^\circ\text{C}$ whichever is larger, $\pm 1$ digit max.	$\pm 0.5\%$ of set/indication value or $\pm 1^\circ\text{C}$ whichever is larger, $\pm 1$ digit max.
Hysteresis	0.0° to 999.9°C/°F (in units of 0.1°C/°F) (during ON/OFF control)	
Proportional band	0.0° to 999.9°C/°F (in units of 0.1°C/°F)	
Integral (reset) time	0 to 9999 s (in units of 1 s)	
Derivative (rate) time	0 to 9999 s (in units of 1 s)	
Control period	1 to 99 s (in units of 1 s)	
Sampling period	500 ms	
Output refresh period	500 ms	
Input shift range	-99.9° to 999.9°C/°F (in units of 0.1°C/°F)	
Alarm output setting range	-999° to 9999°C/°F (in units of 1°C/°F)	-99.9° to 999.9°C/°F (in units of 0.1°C/°F)
Alarm modes	Upper- and lower-limit alarm, upper-limit alarm, lower-limit alarm, upper- and lower-limit range alarm, upper- and lower-limit alarm with standby sequence, upper-limit alarm with standby sequence, lower-limit alarm with standby sequence, absolute-value upper-limit alarm, absolute-value lower-limit alarm	
Manual	W225	



### Typical Application

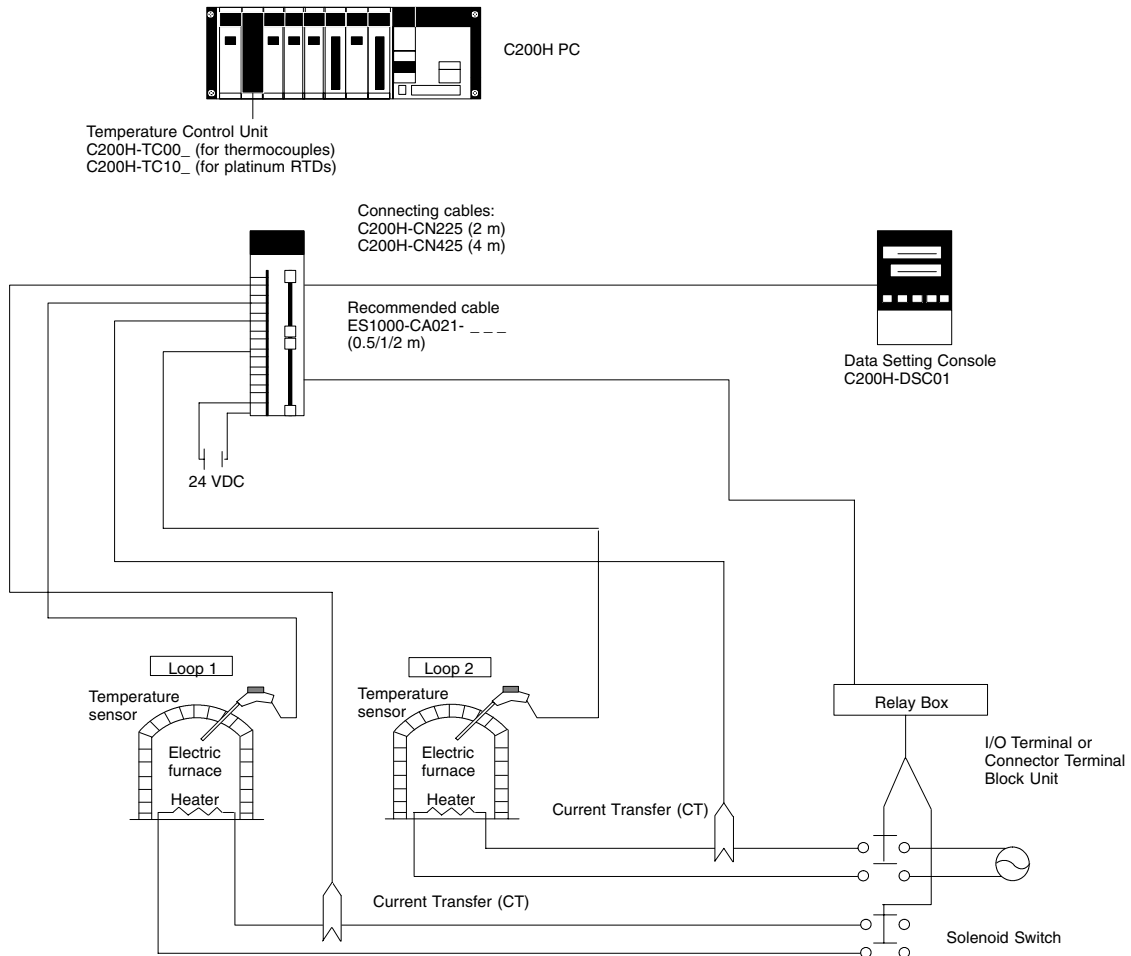

### Output Characteristics

#### Transistor Output (Pulse) C200H-TC\_01

External supply voltage	24 VDC +10%/15%
Max. load voltage	24 VDC max.
Max. load current	100 mA max.
Residual voltage when ON	3 V max.
Leakage current when OFF	0.3 mA max.

#### Voltage Output (Pulse) C200H-TC\_02

Output voltage	12 VDC
Max. load current	40 mA max. (with short-protective circuit)

#### Current Output (Linear) C200H-TC\_03

Output current	4 to 20 mA
Permissible load impedance	600Ωmax.
Current value accuracy	4 ±0.3 to 20 ±1 mA

1

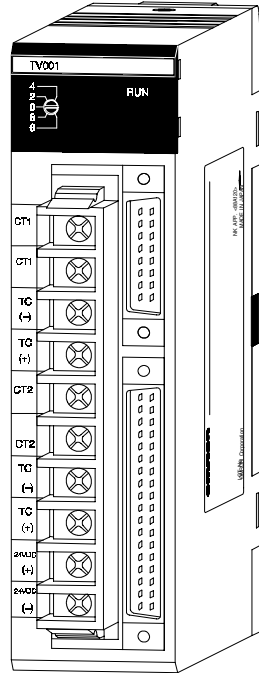

C200H-TV001

**General Information**

Two heat/cool temperature controllers are built into a single slot module. Use them to control processes near ambient temperature or an application with a cooling jacket. These controllers offer PID with auto-advanced tuning of parameters. Use the C200H-DSC01 Data Setting Console to program and monitor settings.

**Features**

- ◆ Auto-tuning of PID parameters
- ◆ Heating and cooling in same module
- ◆ Eight banks of settings data
- ◆ Heater burnout detection alarm
- ◆ Ten alarm modes
- ◆ Thermocouple or RTD inputs
- ◆ Transistor, current or voltage outputs
- ◆ Optional data setting console

**Specifications**

Part numbers	C200H-TV0 _ _	C200H-TV1 _ _
Inputs	2 (two independent control loops)	
Temperature sensor inputs	Thermocouple (R, S, K, J, T, E, B, N, L, V)	RTD (JPt 100, Pt 100)
Control mode	PID, ON/OFF (Advanced PID with auto-tuning)	
Setting indication accuracy	$\pm 0.5\%$ of set/indication value or $\pm 2^\circ\text{C}$ whichever is larger, $\pm 1$ digit max.	$\pm 0.5\%$ of set/indication value or $\pm 1^\circ\text{C}$ whichever is larger, $\pm 1$ digit max.
Hysteresis	0.0° to 999.9°C/°F (in units of 0.1°C/°F) (during ON/OFF control)	
Proportional band	0.0° to 999.9°C/°F (in units of 0.1°C/°F)	
Integral (reset) time	0 to 9999 s (in units of 1 s)	
Derivative (rate) time	0 to 9999 s (in units of 1 s)	
Control period	1 to 99 s (in units of 1 s)	
Deadband	-999 to 999.9 s	
Cooling coefficient	0.01 to 99.99	
Sampling period	500 ms	
Output refresh period	500 ms	
Input shift range	-99.9° to 999.9°C/°F (in units of 0.1°C/°F)	
Alarm output setting range	-999° to 9999°C/°F (in units of 1°C/°F)	-99.9° to 999.9°C/°F (in units of 0.1°C/°F)
Manual	W240	

### Typical Application

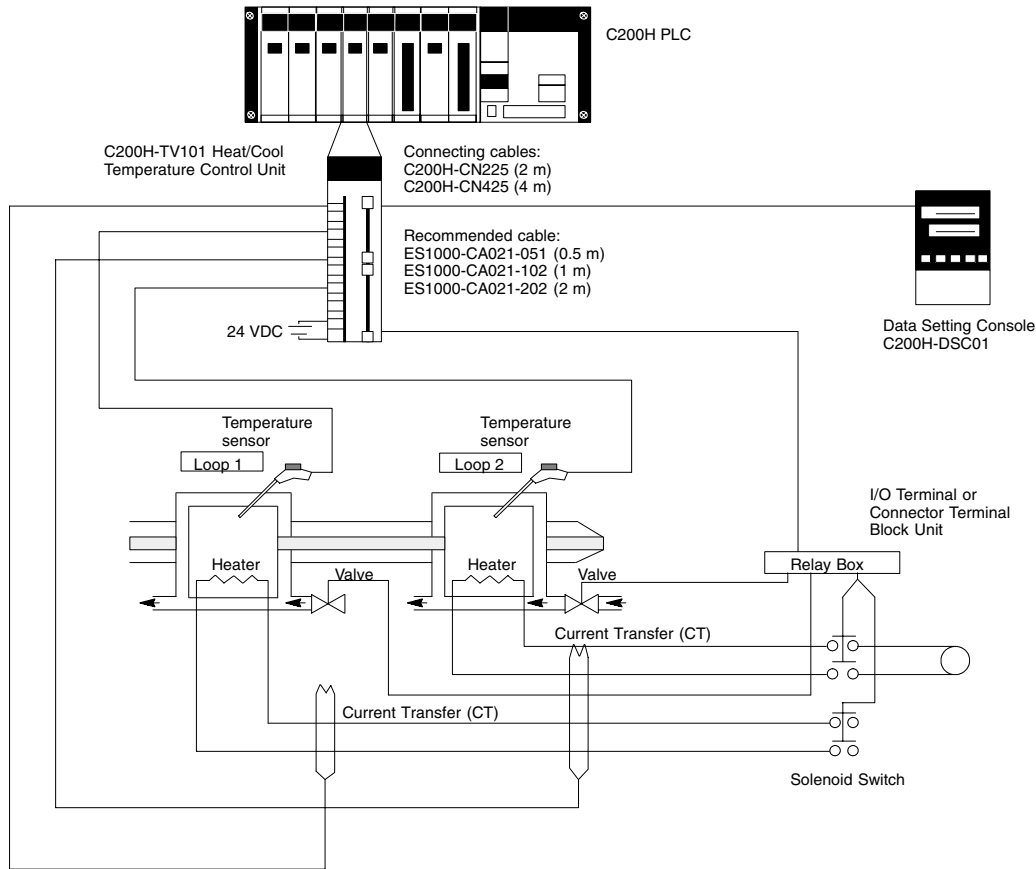

### Output Characteristics

#### Transistor Output (Pulse) C200H-TV\_01

External supply voltage	24 VDC +10%/-15%
Max. load voltage	24 VDC (collector supplied voltage) max.
Max. load current	100 mA max.
Residual voltage when ON	3 V max.
Leakage current when OFF	0.3 mA max.

#### Voltage Output (Pulse) C200H-TV\_02

Output voltage	12 VDC
Max. load current	40 mA (with short-protective circuit)

#### Current Output (Linear) C200H-TV\_03

Output current	4 to 20 mA
Permissible load impedance	600Ωmax.
Current value accuracy	4 ±0.3 to 20 ±1 mA

1

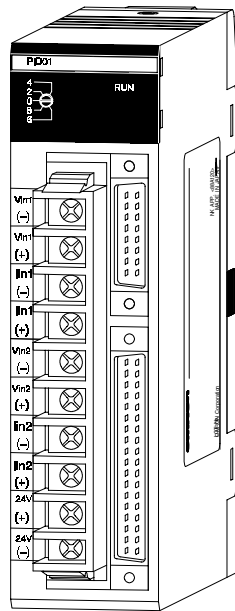

C200H-PID01

### General Information

This module provides two independent PID loops for process control right on the PLC rack. Based on Omron's E5EX-LA process controller the C200H-PID0\_ accepts both current and voltage analog inputs for pressure, flow and other measurements. The module can be programmed and controlled from the PLC or Data Setting Console.

### Features

- ◆ Auto-tuning of PID constants
- ◆ High-speed sampling period
- ◆ Input noise reduction filter
- ◆ Eight banks of settings data
- ◆ Optional data setting console
- ◆ Transistor, current or voltage outputs

### Specifications

Part numbers	C200H-PID0 _
Inputs	2 (two independent control loops)
Input signals	4-20 mA, 1-5 V, 0-5 V, 0-10 V
Control mode	PID, ON/OFF (advanced PID with auto-tuning)
Setting indication accuracy	$\pm 0.5\% \pm 1$ digit max. The SV and displayed value match. There is no relative error.
Hysteresis	0.0° to 100.0% FS (in units of 0.1% FS)
Alarm hysteresis	0.0° to 100.0% FS (in units of 0.1% FS)
Proportional band	0.0 to 999.9 s (in units of 0.1)
Integral (reset) time	0 to 9999 s (in units of 1 s)
Derivative (rate) time	0 to 9999 s (in units of 1 s)
Control period	1 to 99 s (in units of 1 s)
Sampling period	100 ms
Output refresh period	100 ms
Scaling setting range	-999° to 9999 (Decimal point position is designated by parameter setting)
Digital filter setting range	0 to 100 s (in units of 1 s)
Manual output setting range	-5 to 105%
Manual	W241

### Typical Application

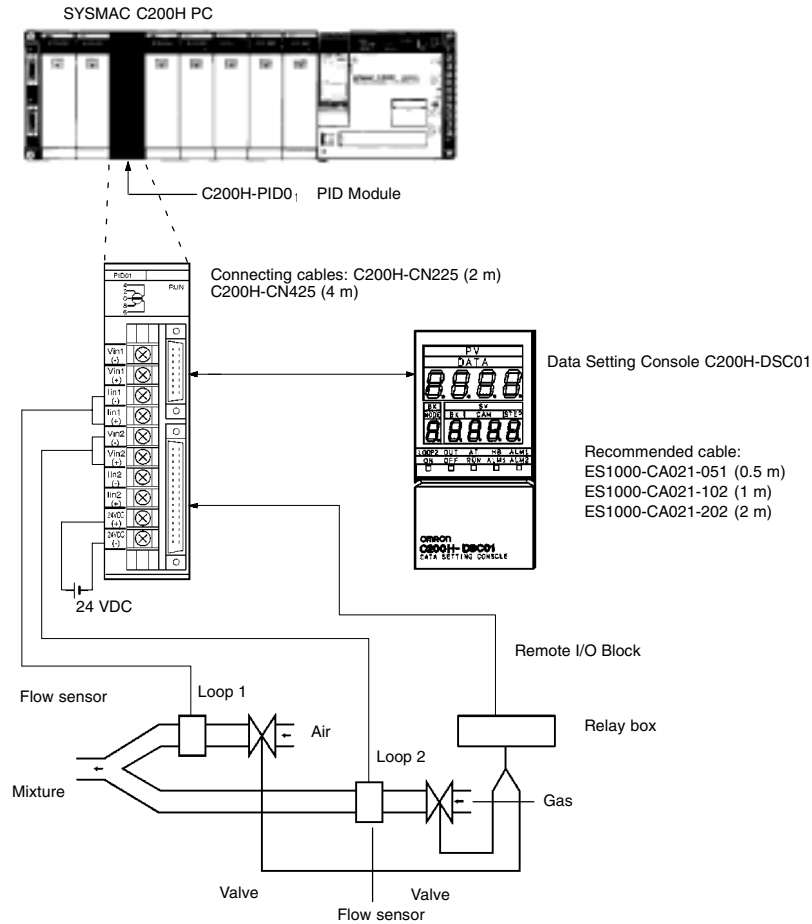

### Output Characteristics

#### Transistor Output (Pulse) C200H-PID01

External supply voltage	24 VDC +10%/-15%
Max. load voltage	24 VDC (collector supplied voltage) max.
Max. load current	100 mA max.
Residual voltage when ON	3 V max.
Leakage current when OFF	0.3 mA max.

#### Voltage Output (Pulse) C200H-PID02

Output voltage	12 VDC
Max. load current	40 mA (with short-protective circuit)

#### Current Output (Linear) C200H-PID03

Output current	4 to 20 mA
Permissible load impedance	600Ωmax.
Current value accuracy	4 ±0.3 to 20 ±1 mA

1

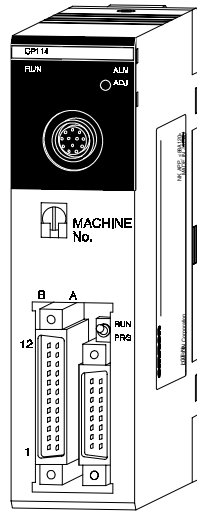

C200H-CP114

**General Information**

The C200H-CP114 Cam Positioner Module simulates a rotating mechanical cam, drum sequencer, or programmable limit switch in a PLC I/O module. The module provides a resolver interface and uses the Data Setting Console for displaying values.

**Features**

- ◆ 16 external and 32 internal cam outputs
- ◆ 7 ON/OFF points per cam output
- ◆ ON/OFF data can be set or altered by moving the machine
- ◆ Uses data setting console for inputting data and displaying values

**Specifications**

<b>Part number</b>	<b>C200H-CP114</b>
<b>Cam outputs</b>	48 (16 external; 32 internal)
<b>External outputs</b>	NPN transistor; 100 mA switching at 24 VDC
<b>Simultaneous ON points</b>	8 points, max.
<b>Resolvers</b>	3F88L-RS17, 3F88L-RS17T, 3F88L-RS15, 3F88L-RS15W
<b>Resolver response</b>	800 rpm (resolver rpm)
<b>Resolver resolution</b>	1°
<b>Origin adjustment</b>	1° to 359°
<b>Angle detection cycle</b>	200 μs (at a sampling frequency of 5 kHz)
<b>Cam output response time</b>	400 μs (800 rpm)
<b>Manual</b>	W224

NOTE: 3F88L-RS15 and 3F88L-RS15W each require a resolver cable.

### Typical Application

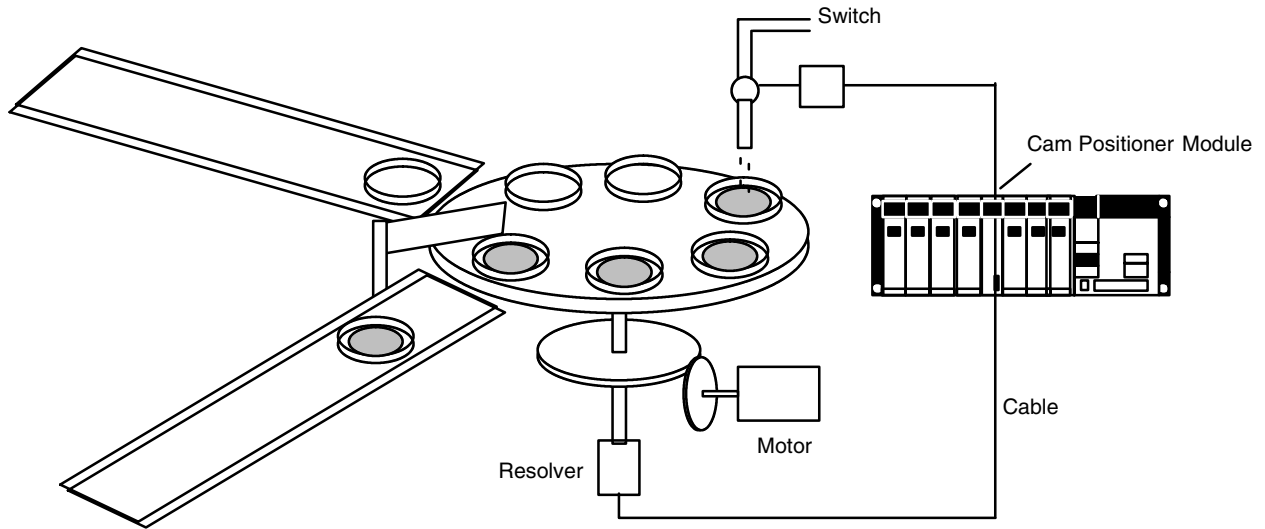

1

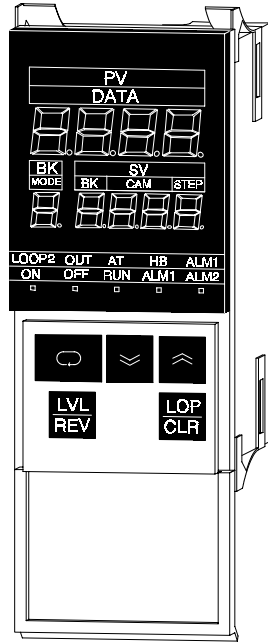

C200H-DSC01

## General Information

The C200H-DSC01 Data Setting Console displays data on its front panel and allows data monitoring and setting when connected to C200H Temperature Controller, Cam Positioner, or PID modules. One Data Setting Console can monitor a single Module. Included with the C200H-DSC01 are mounting brackets, panel decals for modules to identify units and a temperature unit label.

## Features

- ◆ Fits 1/8 DIN cutouts
- ◆ 2 m or 4 m cable
- ◆ Change set values, parameters
- ◆ Monitor present value, set value and memory bank number as well as output status

## Specifications

<b>Part number</b>	<b>C200H-DSC01</b>
<b>Size</b>	1/8 DIN (48 x 96 mm)
<b>Applicable modules</b>	C200H-TC_ __, C200H-TV_ __, C200H-PID_ __, C200H-CP114
<b>Display data</b>	Set value, present value, bank number, auto-tuning, heater burnout alarm, mode, bank, step, cam number, ON/OFF, run, alarm 1 and 2
<b>Connecting cables</b>	2 m: C200H-CN225 4 m: C200H-CN425
<b>Enclosure rating</b>	IP20 (For NEMA 4 rating, use a Y29-49N cover.)





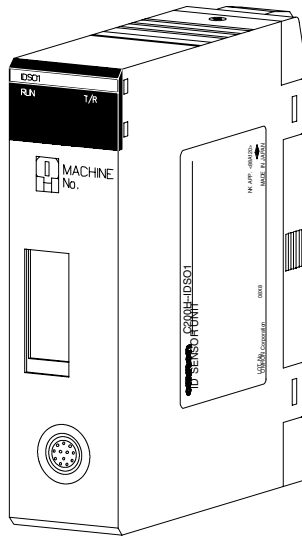

C200H-IDS01

**General Information**

The RF ID Modules provide a direct interface to Omron's V600 and V620 C200H RF ID Sensor Read/Write Heads. The module acts as the controller for Read/Write Heads that exchange data with data carriers using RF technology. Applications include conveyor and pallet storage, product labeling, warehousing applications, and more. Up to 8 Kb of data can be stored on a single data carrier. The interface modules provide a quick and easy interface to the production line PLC using ladder diagram programming.

**Features**

- ◆ Provide flexibility in handling individual workpieces or pallets by reading product specifications can be read from ID data carriers (tags)
- ◆ Allows up-to-date access information on inventory and material flow
- ◆ System consists of an ID controller or SYSMAC C200H-IDS module, Read/Write (R/W) heads, and data carriers (tags)
- ◆ Three read/write ranges available
- ◆ Direct monitoring from the C200H-IDS module with hand-held programming console

**Specifications**

Part number	C200H-IDS01-V1	C200H-IDS21
Read/Write Head-to-Data Carrier range	Short-range	Mid- or long-range
Distance from Read/Write Head to PLC	10 m (32.8 feet) maximum	10 m (32.8 feet) maximum
Communications protocol	Special I/O protocol	
Max. Read/Write Heads	1	
Data Carrier (tag)	2 Kbytes and 8 Kbytes, RAM type (internal battery), 8-bit format	
Processing functions	Commands	Six: read, write, auto-read, auto-write, clear all, auto-read/write cancel
	Transmittable data quantity	Transmission of up to 512 characters (1,024 bytes); 20 characters/transmission
	Diagnostic functions	CPU watchdog timer; six kinds of errors detectable, including communication error with tag, tag missing error, horizontal parity transmission error; error logging function; storing the above errors (by a super capacitor) in memory
Monitoring function	Possible with hand-held programming console Cable length: 4 m (13 feet) max. 1-byte read, 1-byte write, consecutive write, test, error record monitor	
Memory backup	Internal capacitor stores only error data for 15 days at 25°C (77°F)	
Power supply	None	
Manual	W153	

### Typical Application

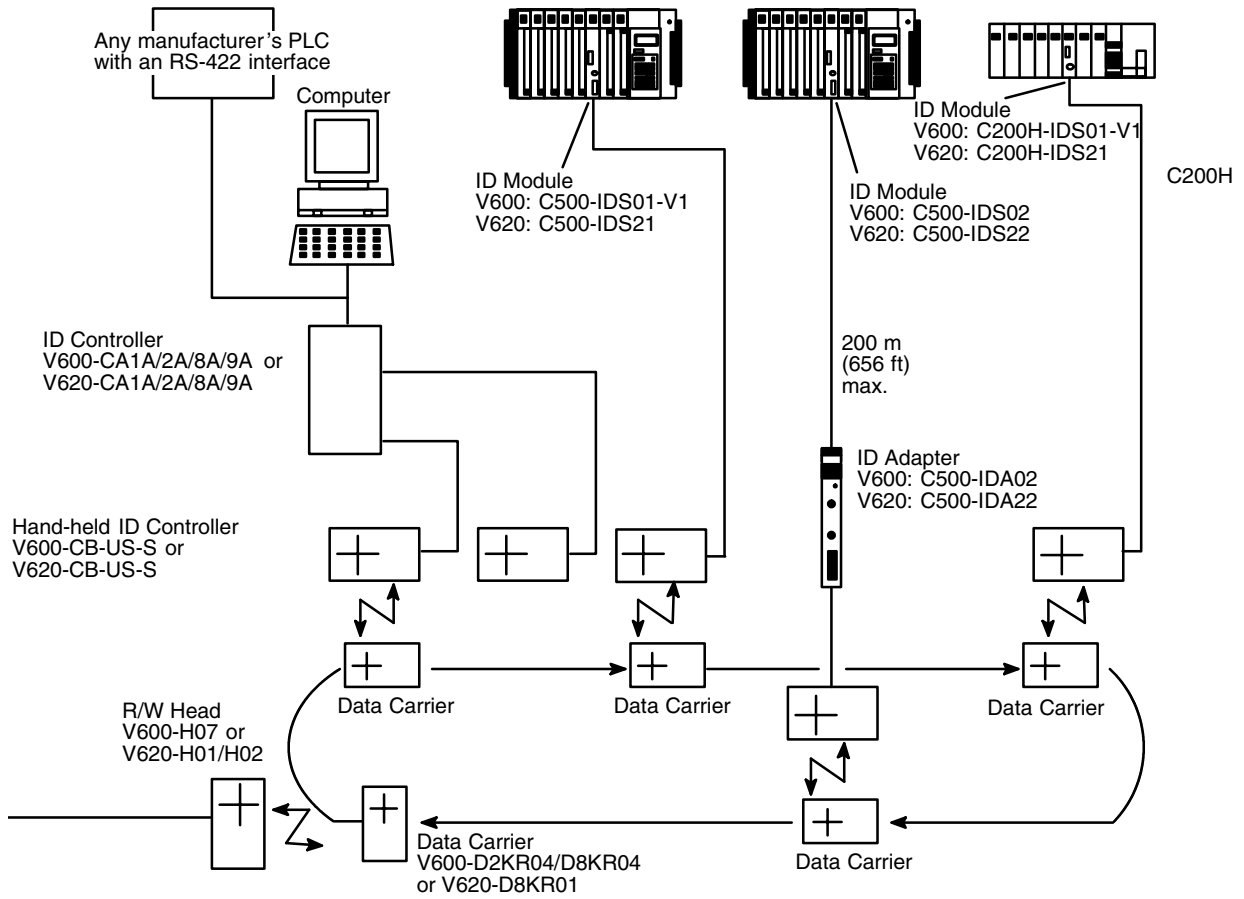

1

1

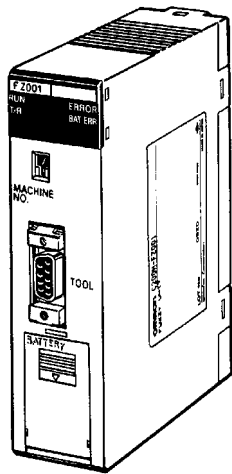

C200H-FZ001

**General Information**

The Fuzzy Coprocessor Module allows state-of-the-art fuzzy inference capabilities to be closely integrated with Omron's large-rack PLCs. In addition to normal ladder logic control, the PLC CPU allows pre-processing and post-processing of fuzzy I/O, which is provided by standard Analog I/O Modules, and/or internal registers in the PLC CPU, using intelligent I/O READ and WRITE instructions in ladder logic.

**Features**

- ◆ Up to 8 inputs, 4 outputs
- ◆ Up to 128 rules
- ◆ User-definable membership functions
- ◆ PLC provides pre-processing and post-processing of fuzzy I/O
- ◆ Simple integration into existing control systems

**Specifications**

<b>Part number</b>	<b>C200H-FZ001</b>
<b>Rule format</b>	8 conditions, 2 conclusions
<b>Maximum number of rules</b>	128 rules
<b>Inference system</b>	MIN-MAX logic
<b>Inference speed</b>	Max. 125 $\mu$ s per rule
<b>Inference time formula</b>	$(125 \mu\text{s} \times \text{number of rules}) + 600 \mu\text{s}$
<b>Defuzzification method</b>	Centroid
<b>Conditions (IF) section</b>	Continuous-function type, maximum 7 definable points
<b>Conclusion (THEN) section</b>	Discrete-type, 25 sections on horizontal axis, 2048 steps on vertical axis
<b>Inputs</b>	8 maximum, 12 bit/input
<b>Outputs</b>	4 maximum, 12 bit/output
<b>Transmission speeds</b>	Up to 19,200 bps (set by internal switch)
<b>Interface</b>	RS-232C, 1 port
<b>Manual</b>	W208

### Typical Application

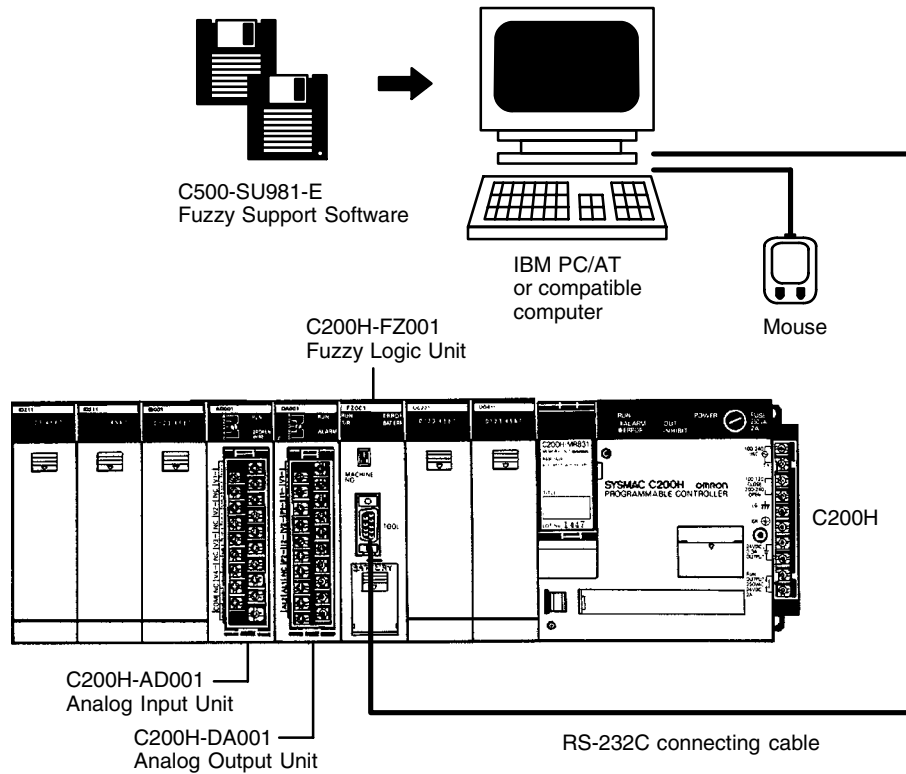

Note: Do not mount the C200H-FZ001 in the 2 slots next to the CPU on the CPU Rack.

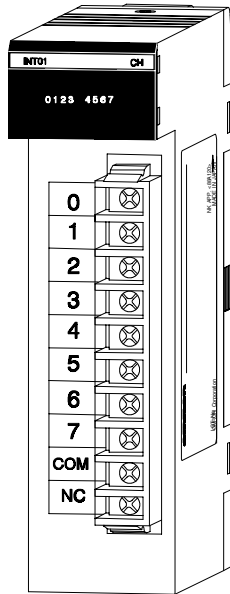

C200HS-INT01

### General Information

The Interrupt Input Module allows real world discrete inputs to interrupt the scan of the main ladder logic program and execute specific interrupt ladder logic. For systems requiring immediate response and fast throughput from field input signals, the Interrupt Input Module can provide fast sub-scan execution and response times. The Module can be configured to provide immediate interrupts and scheduled interrupts which repeat execution on a preset time base. Interrupts can also be configured to interrupt currently executing interrupt logic.

### Features

- ◆ High-speed immediate or scheduled logic execution
- ◆ Provides sub-scan response to field input signals
- ◆ Ladder Instructions control and monitor Interrupt Inputs

### Specifications

<b>Part number</b>	<b>C200HS-INT01</b>
<b>Points per module</b>	8 isolated
<b>Input voltage</b>	12 to 24 VDC
<b>Input current</b>	13 mA at 24 VDC
<b>Input impedance</b>	1.5 k $\Omega$
<b>ON voltage</b>	10.2 VDC minimum
<b>OFF voltage</b>	3.0 VDC maximum
<b>ON delay</b>	1 ms maximum
<b>OFF delay</b>	1.5 ms maximum
<b>Manual</b>	W263 C200HS Installation Guide

### Typical Application

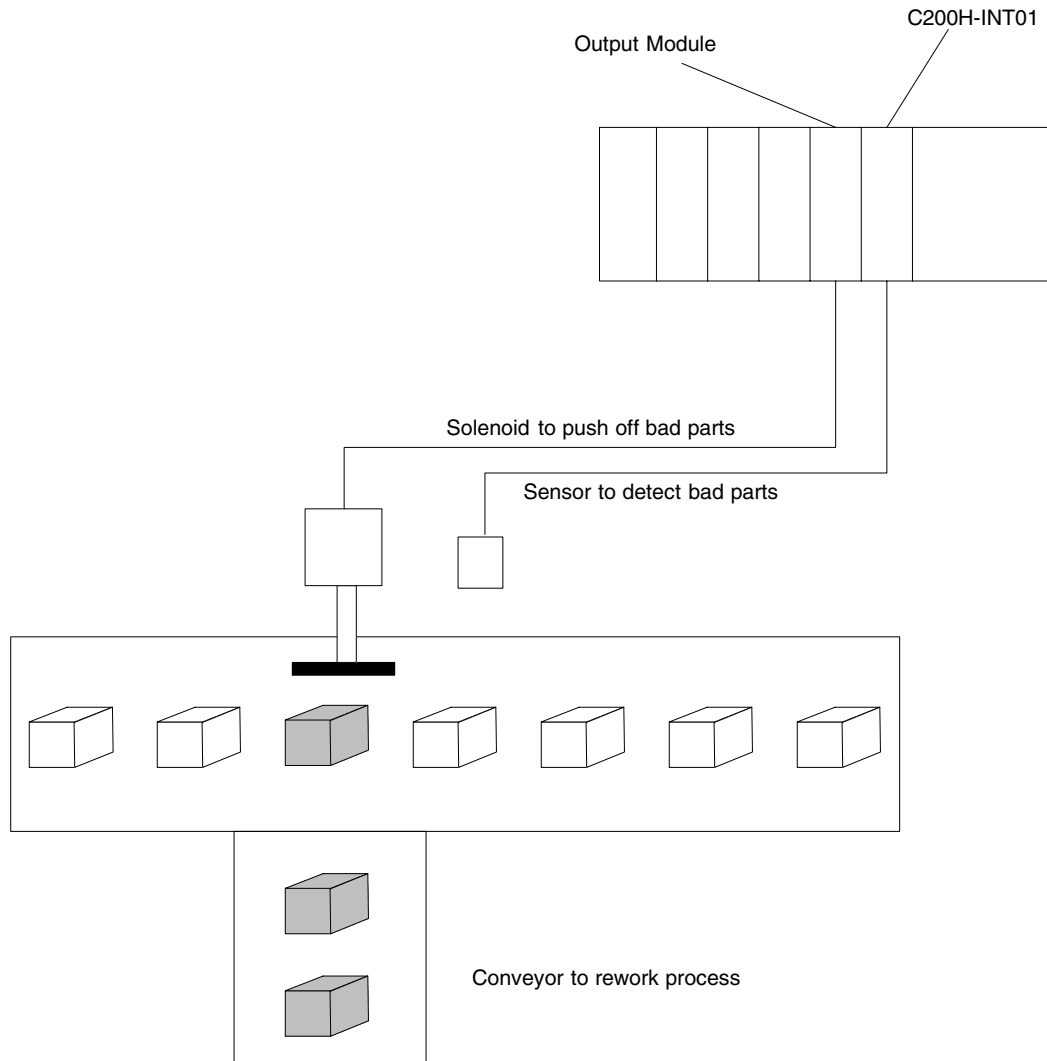

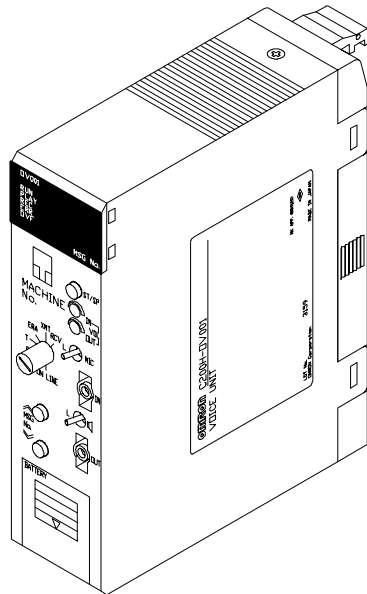

C200H-OV001

**Input Devices**

- Computer
- Microphone
- Tape recorder

**Output Devices**

- Computer
- Printer
- Speaker

**General Information**

Use this module for operator interface messages. Record up to 60 voice messages on site, or use a tape recorder and transfer the messages to the module. Messages can also be uploaded or downloaded through the RS-232C port on the front panel. The built-in speaker enables immediate message verification. Message length and sound quality are selectable.

**Features**

- ◆ Microphone jack enables live message broadcast
- ◆ Flexible message length
- ◆ Messages can be interrupted to start another message
- ◆ Messages can be recorded in phrase and word combination formats
- ◆ Upload or download messages through the RS-232C port on the front panel

**Specifications**

<b>Part number</b>	<b>C200H-OV001</b>	
<b>Voice synthesis method</b>	Adaptive Differential Pulse-Coded Modulation (ADPCM)	
<b>Message recording time</b>	32/48/64 seconds (switch selectable)	
<b>Message capacity</b>	60 max.	
<b>Message input (switch-selectable)</b>	<b>MIC IN</b>	Microphone input: unbalanced dynamic microphone (600 Ω)
	<b>LINE IN</b>	Tape input: Input impedance: 50 k Ω, unbalanced Maximum input voltage: 3.3 V
<b>Message output (switch-selectable)</b>	<b>SPEAKER OUT</b>	Built-in amplifier output: 0.14 W (8 Ω speaker)
	<b>LINE OUT</b>	External amplifier output: 600 Ω unbalanced transformer output Maximum output voltage: 0.5 V rms (effective value) Both balanced and unbalanced external amplifiers can be connected.
<b>Built-in monitor speaker</b>	Diameter 27 mm, 0.1 W (8 Ω)	
<b>Input frequency</b>	32-second recordings: 8 kHz 48-second recordings: 5.3 kHz 64-second recordings: 4 kHz	
<b>Output frequency characteristics</b>	32-second recordings: 100 Hz to 3.2 kHz 48/64-second recordings: 100 Hz to 2.2 kHz	
<b>Lowpass filter function</b>	Cutoff frequency: 3.2 kHz for 32-second recordings, 2.2 kHz for 48/64-second recordings	
<b>Message memory</b>	128K bytes RAM (battery powered)	
<b>External communications</b>	RS-232C (Baud rate: 19,200/9,600/4,800/2,400 bps. XON/XOFF: yes/no, CTS/RTS: yes/no)	
<b>Self-diagnosis function</b>	CPU watchdog timer, LOW battery voltage detection	
<b>Battery life</b>	5 years at 25°C (battery life is shorter for higher temperatures)	
<b>Manual</b>	W172	



### Typical Application

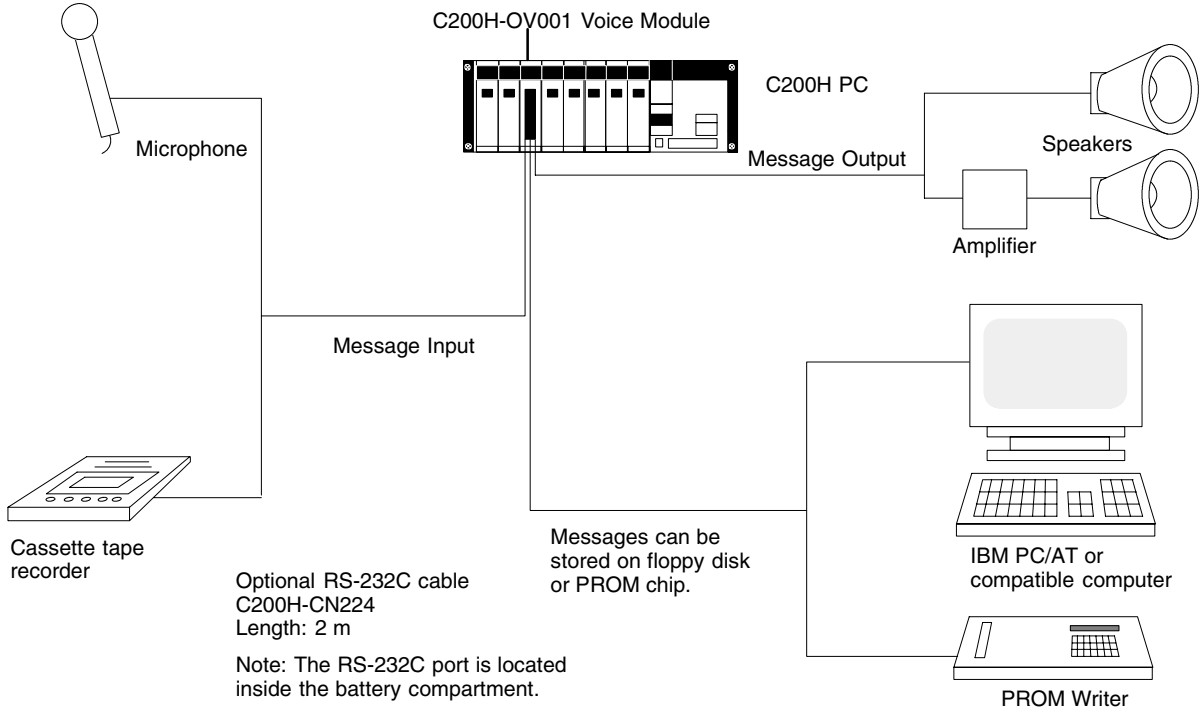

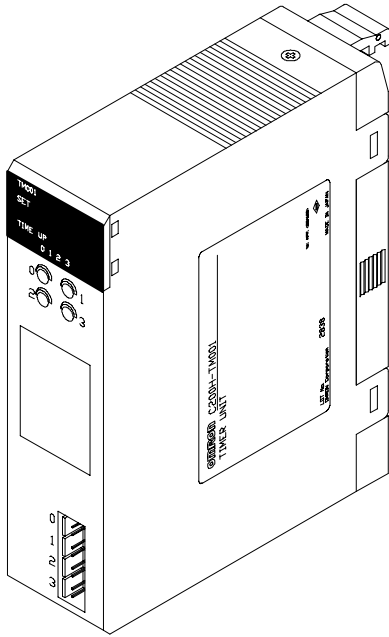

C200H-TM001

**General Information**

The analog timer module lets the user adjust timer values without going into the program. The module has four independently set and monitored timers that each have variable ranges. The user may select, by DIP switch, for each point to use front panel variable resistor or external variable resistors. Through internal bit allocation, each timer can be started and paused, allowing for them to be used as cumulative timers.

**Features**

- ◆ Four front panel variable resistors are used to set the timers
- ◆ Connections available for external variable resistors
- ◆ Indicators show operation and time-up status
- ◆ Cumulative timer available using pause bits

**Specifications**

<b>Part number</b>	<b>C200H-TM001</b>
<b>Number of timers</b>	4
<b>Time setting range (DIP switch selectable)</b>	Use the DIP switches to set any of the following 4 ranges: 0.1 to 1 second (typical) 1 to 10 seconds (typical) 10 to 60 seconds (typical) 1 to 10 minutes (typical)
<b>Indicators</b>	SET and TIME UP
<b>Timer pause function</b>	Timing can be paused if specified by program. The timers can be used as cumulative timers.
<b>External variable resistor</b>	External variable resistors can be used to set the time value when the IN/EXT selector is set to EXT.
<b>Manual</b>	C200H Installation Guide: W111

1

### Typical Application

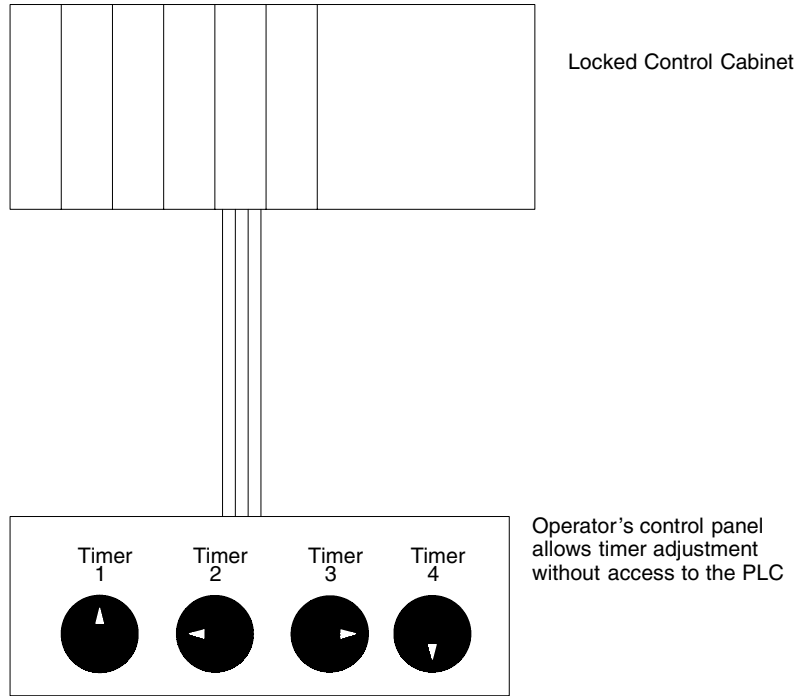

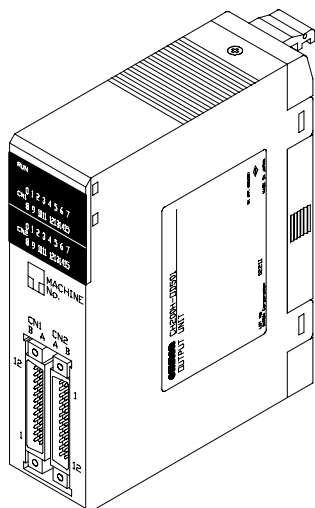

C200H-ID215  
C200H-ID501

## General Information

The High-density Input Modules let you pack more I/O points into a single I/O slot for greater space savings. Being treated as Special I/O modules, they do not use standard I/O points. Thus, they increase the overall I/O capacity. They provide 32 discrete input points with selectable response times of 2.5 ms or 15 ms. For even shorter signals, 8 inputs can be designated as quick-response inputs, to receive selectable 1 ms or 4 ms signals. The modules can also be used with Omron's input blocks, reducing wiring between control panels as well as within control panels.

## Features

- ◆ 8 quick-response inputs available to receive short signals
- ◆ Easy cable connection to I/O Block
- ◆ Selectable input response time
- ◆ Up to 10 special high-density modules per PLC

## Specifications

Part number	C200H-ID215	C200H-ID501
Input voltage	24 VDC +10%/-15%	5 VDC ±10%
No. of inputs (per common)	32 pts (8 pts/com, 4 circuits) 8 quick-response points available	32 pts (8 pts/com, 4 circuits) 8 quick-response points available
Input current	4.1 mA, typical	3.5 mA, typical
Operating voltage	ON	14.4 VDC min.
	OFF	5.0 VDC max.
Input response time	ON	2.5 ms max./15 ms max. (selectable)
	OFF	2.5 ms max./15 ms max. (selectable)
Style/External connections	Connector	Connector
Input device requirement	Sinking (NPN)	Sinking (NPN)
Manual	C200H Installation Guide: W111	

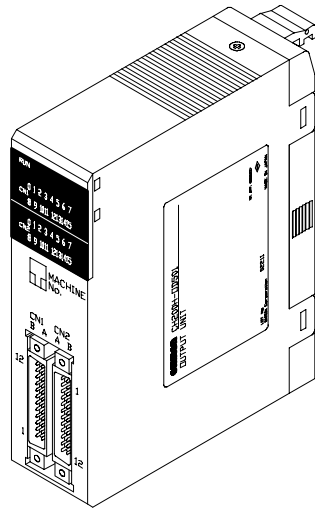

C200H-MD115  
C200H-MD215  
C200H-MD501

### General Information

The high-density/multiplex mixed Input/Output modules let you pack more I/O points into a single I/O slot for greater space savings. Treated as Special I/O modules, they do not use standard I/O points. Thus, they increase the overall I/O capacity.

In static high-density mode, they provide 16 discrete input points and 16 discrete output points with selectable input response times of 2.5 ms or 15 ms. For even shorter input signals, 8 inputs can be designated as quick-response inputs, to receive selectable 1 ms or 4 ms signals. In this mode, the modules can also be used with Omron's I/O Blocks, reducing wiring between control panels as well as within control panels.

In dynamic multiplex input mode, the modules provide 128 dynamic input points. In this mode they can be used with keyboards, thumbwheel switches, etc.

### Features

- ◆ Provide 16 inputs and 16 outputs per module in static mode; 128 inputs in dynamic mode
- ◆ Easy cable connection to I/O block
- ◆ Selectable input response time
- ◆ Up to 10 Special I/O modules per PLC
- ◆ Provide interface to keyboards, thumbwheel switches, etc. in dynamic mode

### Specifications (Static High-density Setting), Input Side (CN2)

Part number	C200H-MD115	C200H-MD215	C200H-MD501
<b>Mounting</b>	CPU Rack: Yes Expansion I/O Rack: Yes Remote I/O Rack: Yes	CPU Rack: Yes Expansion I/O Rack: Yes Remote I/O Rack: Yes	CPU Rack: Yes Expansion I/O Rack: Yes Remote I/O Rack: Yes
<b>Input voltage</b>	12 VDC +10%/-15%	24 VDC ±10%	5 VDC ±10%
<b>No. of inputs (per common)</b>	16 pts (8 pts/com, 2 circuits) 8 quick-response points available	16 pts (8 pts/com, 2 circuits) 8 quick-response points available	16 pts (8 pts/com, 2 circuits) 8 quick-response points available
<b>Input current</b>	4.1 mA, typical	4.1 mA, typical	3.5 mA, typical
<b>Operating voltage</b>	<b>ON</b>	8.0 VDC min.	14.4 VDC min.
	<b>OFF</b>	3.0 VDC max.	5.0 VDC max.
<b>Input response time</b>	<b>ON</b>	2.5 ms max./15 ms max. (selectable)	2.5 ms max./15 ms max. (selectable)
	<b>OFF</b>	2.5 ms max./15 ms max. (selectable)	2.5 ms max./15 ms max. (selectable)
<b>External connections</b>	Connector	Connector	Connector
<b>Input device requirement</b>	Sinking (NPN) or sourcing (PNP)	Sinking (NPN) or sourcing (PNP)	Sinking (NPN) or sourcing (PNP)
<b>Manual</b>	Included in C200H Installation Guide: W111		

1

**Specifications (Static High-density Setting), Output Side (CN1)**

Part number	C200H-MD115	C200H-MD215	C200H-MD501
<b>Max. load current</b>	16 mA 4.5 VDC to 100 mA 26.4 VDC/pt, 800 mA/common, 1.6 A/module	16 mA 4.5 VDC to 100 mA 26.4 VDC/pt, 800 mA/common, 1.6 A/module	35 mA/pt, 280 mA/common, 560 mA/module
<b>Rated load voltage</b>	5 to 24 VDC ±10%	5 to 24 VDC ±10%	5 VDC ±10%
<b>No. of outputs (per common)</b>	16 pts (8 pts/com, 2 circuits)	16 pts (8 pts/com, 2 circuits)	16 pts (8 pts/com, 2 circuits)
<b>Residual voltage</b>	0.7 V max.	0.7 V max.	0.4 V max.
<b>Output response times</b>	<b>ON</b>	0.2 ms max.	0.2 ms max.
	<b>OFF</b>	0.6 ms max.	0.3 ms max.
<b>External connections</b>	Connector	Connector	Connector
<b>Leakage current</b>	0.1 mA max.	0.1 mA max.	0.1 mA max.
<b>Fuse</b>	1 fuse/circuit, 2 circuits (not user-replaceable)		
<b>External power supply</b>	5 to 24 VDC, 45 mA min.	5 to 24 VDC, 45 mA min.	5 VDC, 20 mA min.
<b>Operation</b>	Sinking (NPN)	Sinking (NPN)	Sinking (NPN)

**Specifications (Dynamic Multiplex Setting); Input Only**

Part number	C200H-MD115	C200H-MD215	C200H-MD501
<b>Input voltage</b>	12 VDC +10%/-15%	24 VDC ±10%	5 VDC ±10%
<b>No. of inputs (per common)</b>	128 pts (64 pts/com, 2 circuits)	128 pts (64 pts/com, 2 circuits)	128 pts (64 pts/com, 2 circuits)
<b>Input current</b>	4.1 mA, typical	4.1 mA, typical	3.5 mA, typical
<b>Operating voltage</b>	<b>ON</b>	8.0 VDC min.	3.0 VDC min.
	<b>OFF</b>	3.0 VDC max.	1.0 VDC max.
<b>External connections</b>	Connector	Connector	Connector
<b>Input device requirement</b>	Sinking (NPN)	Sinking (NPN)	Sinking (NPN)

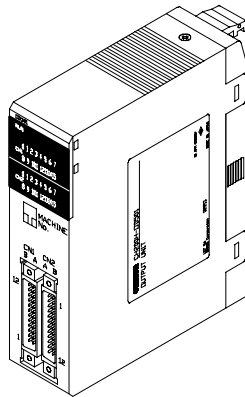

C200H-OD215  
C200H-OD501

### General Information

The High-density/Multiplex Output Modules let you pack more I/O points into a single I/O slot for greater space savings. Treated as Special I/O modules, they do not use standard I/O points. Thus, they increase the overall I/O capacity. In static high-density mode, they provide 32 discrete output points. In this mode, the modules can also be used with Omron's Output Blocks, reducing wiring between control panels as well as within control panels. In dynamic multiplex mode, the modules provide 128 dynamic output points. In this mode they can be used with numeric displays, etc.

1

### Features

- ◆ Provide 32 outputs per module in static mode
- ◆ Easy cable connection to I/O block
- ◆ Up to 10 special high-density modules per PLC
- ◆ Provide interface to numeric displays, etc. in dynamic mode

### Specifications (Static High-density Setting)

Part number	C200H-OD215	C200H-OD501
Max. load current	16 mA 4.5 VDC to 100 mA 26.4 VDC/pt, 800 mA/common, 3.2 A/module	35 mA/pt, 280 mA/common, 1.12 A/module
Rated load voltage	5 to 24 VDC $\pm 10\%$	5 VDC $\pm 10\%$
No. of outputs (per common)	32 pts (8 pts/com, 4 circuits)	32 pts (8 pts/com, 4 circuits)
Residual voltage	0.7 V max.	0.4 V max.
Output response times	ON	0.2 ms max.
	OFF	0.6 ms max.
External connections	Connector	Connector
Leakage current	0.1 mA max.	0.1 mA max.
Fuse	1 fuse/circuit, 4 circuits (not user-replaceable)	
External power supply	5 to 24 VDC, 90 mA min.	5 VDC, 39 mA min.
Operation	Sinking (NPN)	Sinking (NPN)
Manual	W133	

**Specifications (Dynamic Multiplex Setting)**

Part number	<b>C200H-OD215</b>		<b>C200H-OD501</b>	
<b>Max. load current</b>	100 mA/pt, 800 mA/common, 3.2 A/module		35 mA/pt, 280 mA/common, 1.12 A/module	
<b>Rated load voltage</b>	5 to 24 VDC $\pm$ 10%		5 VDC $\pm$ 10%	
<b>No. of outputs (per common)</b>	128 dynamic pts (64 pts/com, 2 circuits)		128 dynamic pts (64 pts/com, 2 circuits)	
<b>Residual voltage</b>	0.7 V max.		0.4 V max.	
<b>Output response times</b>	<b>ON</b>	0.2 ms max.	0.2 ms max.	
	<b>OFF</b>	0.6 ms max.	0.3 ms max.	
<b>External connections</b>	Connector		Connector	
<b>Leakage current</b>	0.1 mA max.		0.1 mA max.	
<b>Fuse</b>	1 fuse/circuit, 4 circuits (not user-replaceable)			
<b>External power supply</b>	5 to 24 VDC, 90 mA min.		5 VDC, 39 mA min.	
<b>Operation</b>	Sinking (NPN)		Sinking (NPN)	

1



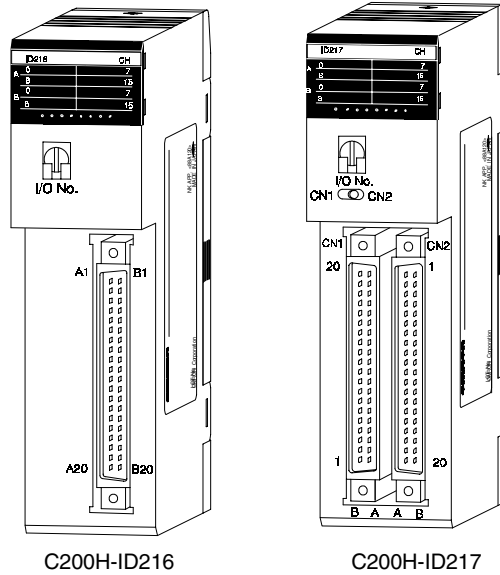

### General Information

The High-density input modules for C200H-CPU21,-CPU23,-CPU31 and C200HS CPUs let you pack more I/O points into a single I/O slot for greater space savings. These modules do not use standard I/O points. Thus, they increase the overall I/O capacity. They provide 32 or 64 discrete input points. The modules can be used with Omron's Input Blocks, reducing wiring between control panels as well as within control panels.

### Features

- ◆ Easy cable connection to input blocks
- ◆ Up to five 64-point modules or 32-point modules per PLC

### Specifications

Part number	C200H-ID216	C200H-ID217
Input voltage	24 VDC	24 VDC
No. of inputs (per common)	32 (32 points/com, 1 circuit)	64 (32 points/com, 2 circuits)
Input current	4.1 mA	4.1 mA
Operating voltage	ON	14.4 VDC min.
	OFF	5.0 VDC max.
Input response time	ON	1.0 ms max.
	OFF	1.0 ms max.
External connections	Connector	Connector
Input device requirement	Sinking (NPN) or sourcing (PNP)	Sinking (NPN) or sourcing (PNP)

NOTE: High density input modules for C200H-CPU21. -CPU23, -CPU31, and C200HS CPU's only.

1

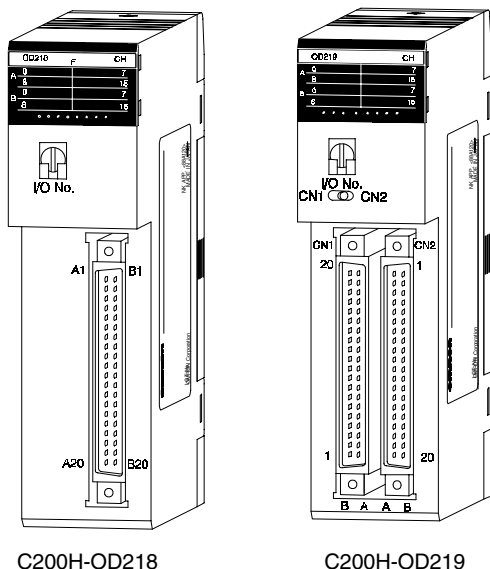

### General Information

The high-density output modules for C200H CPU21, -CPU23, -CPU31 and C200HS CPUs let you pack more I/O points into a single I/O slot for greater space savings. These modules do not use standard I/O points. Thus, they increase the overall I/O capacity. They provide 32 or 64 discrete output points. The modules can be used with Omron's output blocks, reducing wiring between control panels as well as within control panels.

### Features

- ◆ Easy cable connection to output blocks
- ◆ Up to five 64-point modules or 32-point modules per PLC

### Specifications

Part number	C200H-OD218	C200H-OD219
Max. load current	16 mA 4.5 VDC to 100 mA 26.4 VDC	16 mA 4.5 VDC to 100 mA 26.4 VDC
Rated load voltage	5 to 24 VDC	5 to 24 VDC
No. of outputs (per common)	32 (32 points/com, 1 circuit)	64 (32 points/com, 2 circuits)
Residual voltage	0.8 V max.	0.8 V max.
Output response times	ON	0.1 ms max.
	OFF	0.4 ms max.
External connections	Connector	Connector
Leakage current	0.1 mA max.	0.1 mA max.
Fuse	3.5 A (not user-replaceable)	Two, 3.5 A (not user-replaceable)
External power supply	5 to 24 VDC, 110 mA min.	5 to 24 VDC, 220 mA min.
Operation	Sinking (NPN)	Sinking (NPN)

NOTE: High density input modules for C200H-CPU21, -CPU23, -CPU31, and C200HS CPU's only.

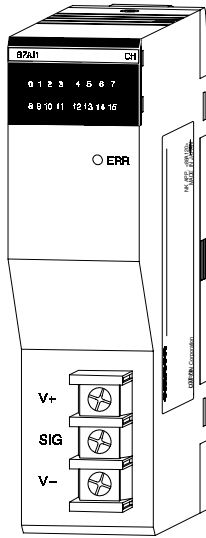

C200H-B7A11

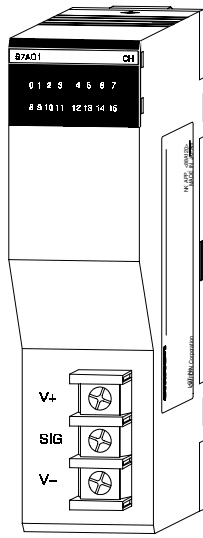

C200H-B7A01

### General Information

The C200H-B7A Interface Modules reduce wiring from 16 input devices or 16 output devices to a few wires. You save control panel space, wiring time, and man-hours required for installation. These modules can be used with the full range of B7A input and output blocks for 16 I/O. The modules require a power supply, as do the terminal blocks.

### Features

- ◆ Connect directly to the B7A I/O blocks using a two-conductor wire
- ◆ Transmission distance up to 500 m max.
- ◆ Used as a standard I/O module with 16 points

### Specifications

Part number	C200H-B7A11	C200H-B7A01
I/O points	16 or 15 input points with 1 error bit	16 output points
Transmission distance (note)	500 m max.	500 m max.
I/O delay	19.2 ms (typical); 31 ms max.	19.2 ms (typical); 31 ms max.
Current consumption	100 mA, max. at 5 VDC	100 mA, max. at 5 VDC
Power supply	10 mA min. at 12 to 24 VDC $\pm$ 10%	30 mA min. at 12 to 24 VDC $\pm$ 10%
Manual	W236	

NOTE: A maximum transmission distance of 500 m is possible if the B7A Interface module and B7A Link Terminal each connect to an external DC power supply with 12 to 24 VDC. A maximum transmission distance of 100 m is possible if a single power supply of 24 VDC  $\pm$ 10% is connected to either the B7A Link Terminal or the interface module.

## Typical Application

1

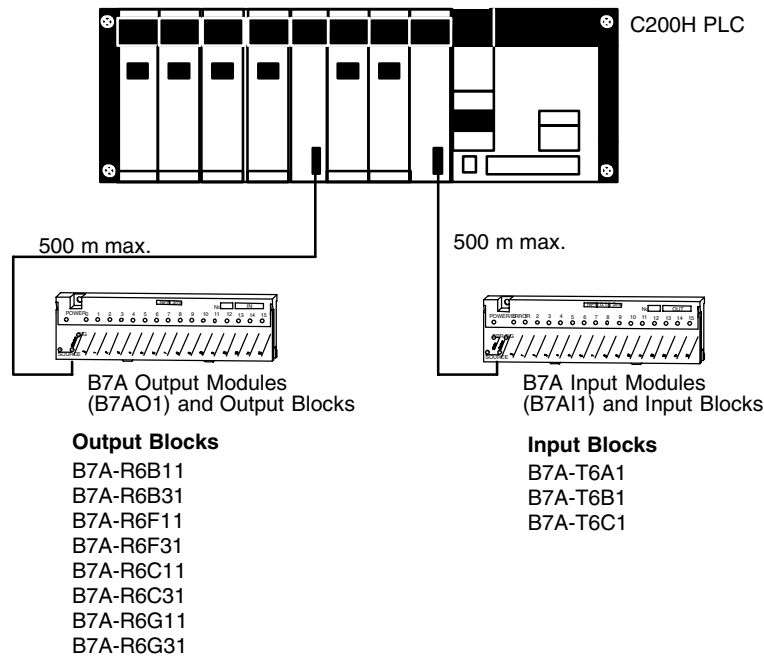

**Note** C200H-B7AI1/B7AO1 units cannot connect to a high speed B7A link terminal with transmission delay time of 3 m sec.

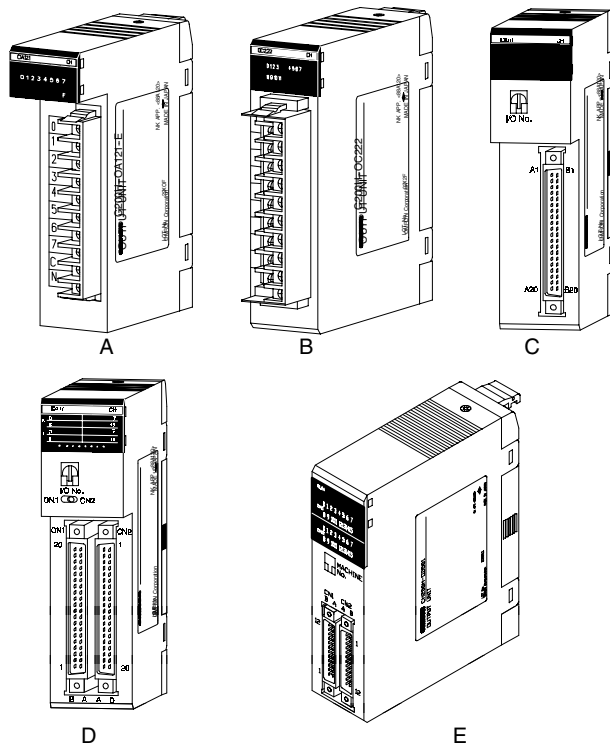

### General Information

Discrete I/O modules are available in a number of voltages, densities, terminal block, and connector types. Connector-style high-density I/O modules with 32 or 64 discrete I/O points per module have solder connectors included with the module.

Optional wiring methods are available using Omron's I/O blocks, screw terminal, crimp and ribbon connectors, and pre-terminated cables. These versatile high-density configuration options minimize rack space and wiring time. The Omron I/O Blocks provide single-point isolation and up to 5 A current capacity per point. Replaceable relays and solid-state plug-in modules allow easy maintenance.

There are five styles of discrete I/O modules in the C200H family. The profiles of each are shown here. Each module in the following pages is cross-referenced to the module style.

Modules include the appropriate connectors. Replacement connectors and terminal blocks for each style are shown here.

Style	Replacement Connector/Terminal
A	4571022-4, PTC-2103
B	4571023-2, PTC-219
C,D	C500-CE401 Solder, 40-pin C500-CE402 Crimp, 40-pin C500-CE403 Ribbon, 40-pin C500-CE404 Solder, right angle C500-CE405 Crimp, right angle
E	C500-CE241 Solder, 24-pin C500-CE242 Crimp, 24 pin C500-CE243 Ribbon, 24 pin

1

**Specifications**

Part number	C200H-ID001	C200H-ID002
Number of inputs (per common)	8 pts (8 pts/com, 1 circuit)	8 pts (8 pts/com, 1 circuit)
Input voltage	No-voltage contact/NPN output type (negative common)	No-voltage contact/NPN output type positive common)
Input current	7 mA, typical	7 mA, typical
Operating voltage		
ON	14.4 VDC min.	14.4 VDC min.
OFF	5.0 VDC max.	5.0 VDC max.
Input response time		
ON	1.5 ms max.	1.5 ms max.
OFF	1.5 ms max.	1.5 ms max.
Style/External connections	A/Removable terminal block	
Input device requirement	-	
Manual	C200H Installation Guide: W111	

**Specifications**

Part number	C200H-ID211	C200H-ID212
Number of inputs (per common)	8 pts (8 pts/com, 1 circuit)	16 pts (16 pts/com, 1 circuit)
Input voltage	12 to 24 VDC +10%/-15%	24 VDC +10%/-15%
Input current	10 mA, 24 VDC	7 mA, typical 24 VDC
Operating voltage		
ON	10.2 VDC min.	14.4 VDC min.
OFF	3.0 VDC max.	5.0 VDC max.
Input response time		
ON	1.5 ms max.	1.5 ms max.
OFF	1.5 ms max.	1.5 ms max.
Style/External connections	A/Removable terminal block	B/Removable terminal block
Input device requirement	Sinking (NPN) or sourcing (PNP)	Sinking (NPN) or sourcing (PNP)
Manual	C200H Installation Guide: W111	

### Specifications

Part number	C200H-IA121	C200H-IA122
Number of inputs (per common)	8 pts (8 pts/com, 1 circuit)	16 pts (16 pts/com, 1 circuit)
Input voltage	100 to 120 VAC +10%/-15%	100 to 120 VAC +10%/-15%
Input current	10 mA, 100 VAC	10 mA, 200 VAC
Operating voltage		
ON	60 VAC min	60 VAC min
OFF	20 VAC max	20 VAC max
Input response time		
ON	35 ms max	35 ms max
OFF	55 ms max	55 ms max
Style/External connections	A/Removable terminal block	B/Removable terminal block
Manual	C200H Installation Guide: W111	

### Specifications

Part number	C200H-IA221	C200H-IA222
Number of inputs (per common)	8 pts (8 pts/com, 1 circuit)	16 pts (16 pts/com, 1 circuit)
Input voltage	200 to 240 VAC +10%/-15%	200 to 240 VAC +10%/-15%
Input current	10 mA, 100 VAC	10 mA, 200 VAC
Operating voltage		
ON	120 VAC min	120 VAC min
OFF	40 VAC max	40 VAC max
Input response time		
ON	35 ms max	35 ms max
OFF	55 ms max	55 ms max
Style/External connections	A/Removable terminal block	B/Removable terminal block
Manual	C200H Installation Guide: W111	

**Specifications**

Part number	C200H-IM211	C200H-IM212
Number of inputs (per common)	8 pts (8 pts/com, 1 circuit)	16 pts (16 pts/com, 1 circuit)
Input voltage	12 to 24 VAC/DC +10%/-15%	24 VAC/DC +10%/-15%
Input current	10 mA, 24 VAC/DC	7 mA, 24 VAC/DC
Operating voltage		
ON	10.2 VAC/DC	14.4 VAC/DC
OFF	3.0 VAC/DC	5.0 VAC/DC
Input response time		
ON	1.5 ms max.	1.5 ms max.
OFF	1.5 ms max.	1.5 ms max.
Style/External connections	A/Removable terminal block	B/Removable terminal block
Type of common	Bipolar common	Bipolar common
Manual	C200H Installation Guide: W111	



### Specifications

Part number	C200H-OD211	C200H-OD212
Number of outputs (per common)	12 pts (12 pt/com, 1 circuit)	16 pts (16 pts/com, 1 circuit)
Max. load current	0.3 mA/pt, 2 A/module	0.3 mA/pt, 2 A/module
Rated load voltage	24 VDC $\pm 10\%$ /-15%	24 VDC $\pm 10\%$ /-15%
Min. switching capacity	Residual voltage: 1.4 V max.	Residual voltage: 1.4 V max.
Output response times		
ON	0.2 ms max.	0.2 ms max.
OFF	0.3 ms max.	0.3 ms max.
Style/External connections	B/Removable terminal block	B/Removable terminal block
Leakage current	0.1 mA max.	0.1 mA max.
Fuse	125 V, 5 A	125 V, 8 A
External power supply	24 VDC, 25 mA min.	24 VDC, 35 mA min.
Operation	Sinking (NPN)	Sinking (NPN)
Manual	C200H Installation Guide: W111	

### Specifications

Part number	C200H-OD213	C200H-OD214
Number of outputs (per common)	8 pts (8 pts/com, 1 circuit)	8 pts (8 pts/com, 1 circuit)
Max. load current	2.1 A/pt, 5.2 A/module	0.8 A/pt, 2.4 A/module
Rated load voltage	24 VDC $\pm 10\%$ /-15%	24 VDC $\pm 10\%$ /-15%
Min. switching capacity	Residual voltage: 1.4 V max.	Residual voltage: 1.5 V max.
Output response times		
ON	0.2 ms max.	1 ms max.
OFF	0.3 ms max.	1 ms max.
Style/External connections	A/Removeable terminal block	A/Removeable terminal block
Leakage current	0.1 mA max.	0.1 mA max.
Fuse	125 V, 8 A	Short-circuit protection
External power supply	24 VDC, 30 mA min.	24 VDC, 150 mA min.
Operation	Sinking (NPN)	Sourcing (PNP)
Manual	C200H Installation Guide: W111	

1

**Specifications**

Part number	C200H-OD216	C200H-OD217
Number of outputs (per common)	8 pts (8 pts/com, 1 circuit)	12 pts (12 pts/com, 1 circuit)
Max. load current	0.3 A/pt	0.3 A/pt
Rated load voltage	5 to 24 VDC, +10%/-15%	5 to 24 VDC, +10%/-15%
Min. switching capacity	10 mA, 5 VDC	10 mA, 5 VDC
Output response times		
ON	1.5 ms max.	1.5 ms max.
OFF	2 ms max.	2 ms max.
Style/External connections	A/Removeable terminal block	B/Removeable terminal block
Leakage current	0.1 mA max.	0.1 mA max.
Fuse	-	-
External power supply	-	-
Operation	Sourcing (PNP)	Sourcing (PNP)
Manual	C200H Installation Guide: W111	

**Specifications**

Part number	C200H-OD411
Number of outputs (per common)	8 pts (8 pts/com, 1 circuit)
Max. load current	1 A/pt, (3 A/module)
Rated load voltage	12 to 48 VDC, +10%/-15%
Min. switching capacity	Residual voltage: 1.4 V max.
Output response times	
ON	0.2 ms max.
OFF	0.3 ms max.
Style/External connections	A/Removeable terminal block
Leakage current	0.1 mA max.
Fuse	125 V, 5 A
External power supply	12 to 48 VDC, 30 mA min.
Operation	Sinking (NPN)
Manual	C200H Installation Guide: W111

### Specifications

Part number	C200H-OA221	C200H-OA222
Number of outputs (per common)	8 pts (8 pts/com, 1 circuit)	12 pts (8 pts/com, 2 circuits)
Max. load current	1 A/pt, 4 A/module	.3 A/pt, 5 A/module
Rated load voltage	200 to 240 VAC	100 to 240 VAC
Min. switching capacity	Resistance load: 10 mA inductive load: 40 mA 10 VAC	Resistance load: 10 mA inductive load: 40 mA 10 VAC
<b>Output response times</b>		
ON	1 ms max.	1 ms max.
OFF	1/2 load frequency max.	1/2 load frequency max.
Style/External connections	A/Removeable terminal block	B/Removeable terminal block
<b>Leakage current</b>		
200 VAC	6 mA max.	6 mA max.
100 VAC	3 mA max.	3 mA max.
Fuse	250 V, 5 A	250 V, 3 A
External power supply	—	—
Manual	C200H Installation Guide: W111	

### Specifications

Part number	C200H-OA121-E
Number of outputs (per common)	8 pts (8 pts/com, 1 circuit)
Max. load current	1 A/pt, 4 A/module
Rated load voltage	100 to 120 VAC
Min. switching capacity	Resistance load: 10 mA inductive load: 40 mA 10 VAC
<b>Output response times</b>	
ON	1 ms max.
OFF	1/2 load frequency max.
Style/External connections	A/Removeable terminal block
<b>Leakage current</b>	
200 VAC	3 mA max.
100 VAC	—
Fuse	125 V, 5 A
External power supply	—
Manual	C200H Installation Guide: W111

1

**Specifications**

Part number	C200H-OC221	C200H-OC222
Number of outputs (per common)	8 pts (8 pts/com, 1 circuit)	12 pts (12 pt/com, 1 circuit), max. 8 ON simultaneously
Max. load current		
AC	2 A/pt. (p.f. = 1), 2 A/pt. (p.f. = 0.4)	2 A/pt. (p.f. = 1), 2 A/pt. (p.f. = 0.4)
DC	2 A/pt., 8 A/module	2 A/pt., 8 A/module
Rated load voltage	250 VAC, 24 VDC max.	250 VAC, 24 VDC max.
Min. switching capacity	10 mA, 5 VDC	10 mA, 5 VDC
Output response times		
ON	10 ms max.	10 ms max.
OFF	10 ms max.	10 ms max.
Style/External connections	A/Removeable terminal block	B/Removeable terminal block
External power supply	10 mA, 24 VDC/pt	10 mA, 24 VDC/pt
Manual	C200H Installation Guide: W111	

**Specifications**

Part number	C200H-OC223	C200H-OC224
Number of outputs (per common)	5 pts (1 pt/com, 5 circuits)	8 pts (1 pt/com, 8 circuits)
Max. load current		
AC	2 A/pt. (p.f. = 1), 2 A/pt. (p.f. = 0.4)	2 A/pt. (p.f. = 1), 2 A/pt. (p.f. = 0.4)
DC	2 A/pt., 8 A/module	2 A/pt., 8 A/module
Rated load voltage	250 VAC, 24 VDC max.	250 VAC, 24 VDC max.
Min. switching capacity	10 mA, 5 VDC	10 mA, 5 VDC
Output response times		
ON	10 ms max.	10 ms max.
OFF	10 ms max.	10 ms max.
Style/External connections	A/Removeable terminal block	A/Removeable terminal block
External power supply	10 mA, 24 VDC/pt	10 mA, 24 VDC/pt
Manual	C200H Installation Guide: W111	

**Specifications**

Part number	C200H-OC225
Number of outputs (per common)	16 pts (1 pt/com, 1 circuit), 8 ON simultaneously
Max. load current	
AC	2 A/pt. (p.f. = 1), 2 A/pt. (p.f. = 0.4)
DC	2 A/pt., 8 A/module
Rated load voltage	250 VAC, 24 VDC max.
Min. switching capacity	10 mA, 5 VDC
Output response times	
ON	10 ms max.
OFF	10 ms max.
Style/External connections	B/Removeable terminal block
External power supply	10 mA, 24 VDC/pt
Manual	C200H Installation Guide: W111

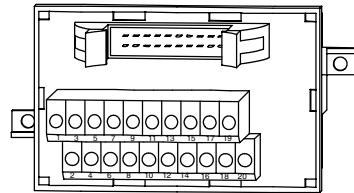

XW2B-20G4

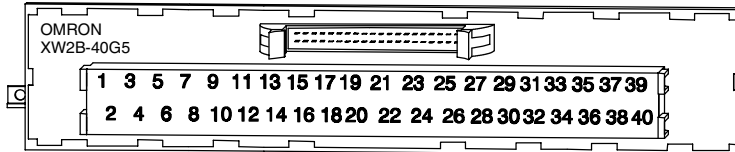

XW2B-40G5

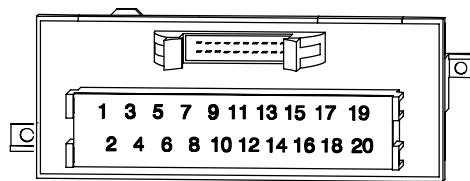

XW2B-20G5

### General Information

XW2B screw terminals allow clean, single-cable connection to 32-point or 64-point high-density I/O modules. The screw terminals enable easier installation, saving time, reducing system cost, and simplifying maintenance. The screw terminals are available in 20- and 40-point densities. The I/O connecting cables are available in lengths from 1 to 5 meters.

### Features

- ◆ Available with either M2.4 or M3.5 terminal screws
- ◆ Easily mounted to DIN rail or control panel
- ◆ Rated for 1 A, 125 VAC or 1 A, 30 VDC

Part Number	Description	Compatible PLC I/O Modules
<b>XW2B-20G4</b>	20-point terminal w/M2.4 screws	C200H-ID215, C200H-OD215, C200H-MD115, C200H-MD215, C200H-MD501, C200H-ID501, C200H-OD501, C500-ID218CN, C500-ID501CN, C500-OD415CN, C500-OD501CN
<b>XW2B-20G5</b>	20-point terminal w/M3.5 screws	
<b>XW2B-40G5-T</b>	40-point terminal w/M3.5 screws (Has two connectors; same as using two XW2B-20G5s)	
<b>XW2B-20G5-D</b>	20-point terminal w/M3.5 screws (Daisy chain application)	
<b>XW2B-40G4</b>	40-point terminal w/M2.4 screws	C200H-ID216, C200H-OD218, C200H-ID217, C200H-OD219, C500-ID114, C500-ID219, C500-OD213
<b>XW2B-40G5</b>	40-point terminal w/M3.5 screws	

For Connecting Cable part numbers, refer to the following page.

## Special 32-point Module

1

**Note** The odd numbers on the screw terminals correspond to column A in the PLC module. The even numbers correspond to column B in the PLC module.

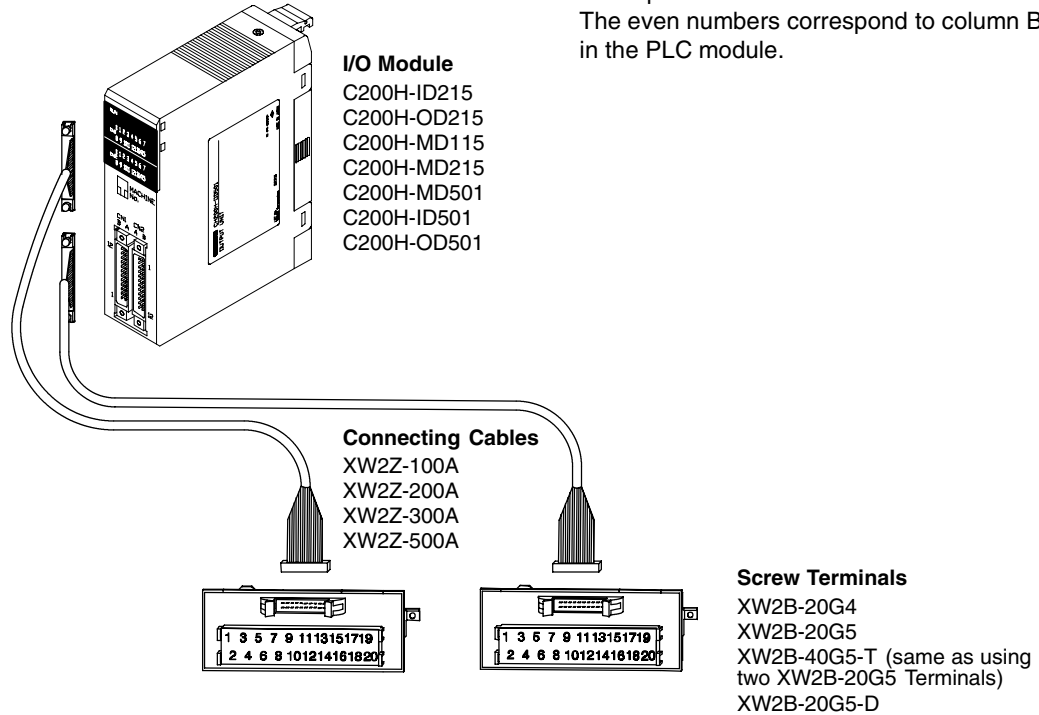

## Group 2 32 and 64-point Module

**Note** The odd numbers on the screw terminals correspond to column A in the PLC module. The even numbers correspond to column B in the PLC module.

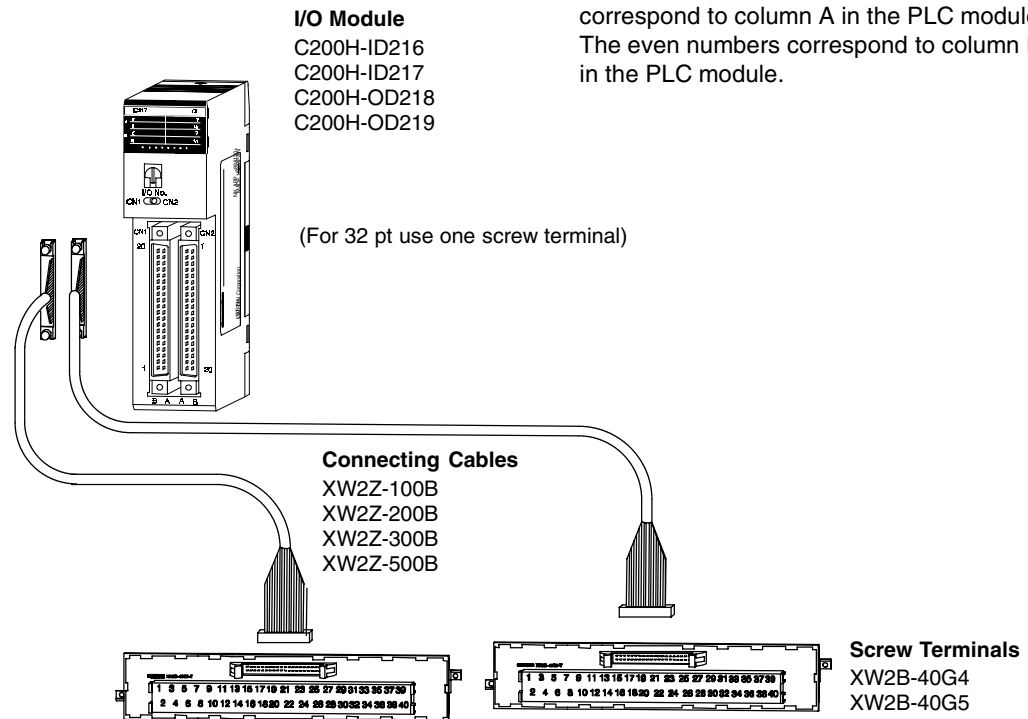

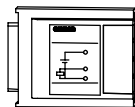

B7A-R6A13  
B7A-R6A33  
B7A-R6A18  
B7A-R6A38

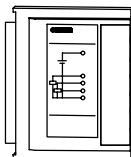

B7R-B3A13  
B7R-B3A33  
B7R-B3A18  
B7R-B3A38

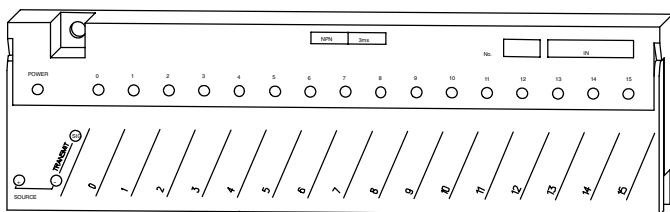

B7A-T6A1  
B7A-T6B1  
B7A-T6A6  
B7A-T6B6  
B7A-T6C1  
B7A-T6C6

### General Information

The B7A Output Connectors connect directly to high-density input modules. The connectors communicate to B7A Input Blocks in a remote location by means of two wires. Field input devices are then wired to the input blocks. This reduces wiring between control panels while saving space and wiring time.

### Features

- ◆ Transmit 16 input signals to high-density input modules over two wires, or 32 input signals over four wires
- ◆ Transmission distances of 100 or 500 meters (high-speed I/O delay of 3 ms)
- ◆ Both NPN and PNP models available
- ◆ LED indicators for easy confirmation of input status
- ◆ Small size of 167 mm x 37 mm (6.57 in x 1.45 in) allows installation in small enclosures
- ◆ DIN rail or control panel mounting

## B7A 16-point Output Connectors

### Specifications – Hold Output

Part number	B7A-R6A13	B7A-R6A18
Rated load voltage	5 to 24 VDC	5 to 24 VDC
Rated load current	50 mA max./point	50 mA max./point
Output configuration	NPN open collector	NPN open collector
I/O delay	Normal-speed 19.2 ms	High-speed 3 ms

### Specifications – Load OFF

Part number	B7A-R6A33	B7A-R6A38
Rated load voltage	5 to 24 VDC	5 to 24 VDC
Rated load current	50 mA max./point	50 mA max./point
Output configuration	NPN open collector	NPN open collector
I/O delay	Normal-speed 19.2 ms	High-speed 3 ms

All B7A Input Blocks require a 12 to 24 VDC power supply. Omron recommends the S82K family of power supplies. Refer to System Configuration for current consumption and formulas for determining the appropriate power supply requirements.

1

**B7A 32-point Output Connectors**

**Specifications – Hold Output**

Part number	<b>B7A-R3A13</b>	<b>B7A-R3A18</b>
Rated load voltage	5 to 24 VDC	5 to 24 VDC
Rated load current	50 mA max./point	50 mA max./point
Output configuration	NPN open collector	NPN open collector
I/O delay	Normal-speed 19.2 ms	High-speed 3 ms

**Specifications – Load OFF**

Part number	<b>B7A-R3A33</b>	<b>B7A-R3A38</b>
Rated load voltage	5 to 24 VDC	5 to 24 VDC
Rated load current	50 mA max./point	50 mA max./point
Output configuration	NPN open collector	NPN open collector
I/O delay	Normal-speed 19.2 ms	High-speed 3 ms

**B7A 16-point Input Blocks**

**Specifications**

Part number	<b>B7A-T6A1</b>	<b>B7A-T6B1</b>	<b>B7A-T6A6</b>
Input configuration	NPN compatible	NPN compatible	NPN compatible
Input voltage	No-voltage contact, two-wire sensors with DC output, NPN output type	No-voltage contact, two-wire sensors with DC output, NPN output type	No-voltage contact, two-wire sensors with DC output, NPN output type
Input current range	3 to 6 mA	3 to 6 mA	3 to 6 mA
Input voltage range	0 VDC to supply voltage	0 VDC to supply voltage	0 VDC to supply voltage
I/O delay	Normal-speed 19.2 ms	Normal-speed 19.2 ms	High-speed 3 ms
Internal I/O common	– common	± common	– common

**Specifications**

Part number	<b>B7A-T6B6</b>	<b>B7A-T6C1</b>	<b>B7A-T6C6</b>
Input configuration	NPN compatible	PNP compatible	PNP compatible
Input voltage	No-voltage contact, two-wire sensors with DC output, NPN output type	No-voltage contact, two-wire sensors with DC output, PNP output type	No-voltage contact, two-wire sensors with DC output, PNP output type
Input current range	3 to 6 mA	3 to 6 mA	3 to 6 mA
Input voltage range	0 VDC to supply voltage	0 VDC to supply voltage	0 VDC to supply voltage
I/O delay	High-speed 3 ms	Normal-speed 19.2 ms	High-speed 3 ms
Internal I/O common	± common	± common	± common

All B7A Input Blocks require a 24 VDC power supply. Omron recommends the S82K family of power supplies. Refer to Standard Parts for part numbers. Refer to System Configuration for current consumption and formulas for determining the appropriate power supply requirements.



### Special 32-point Module

#### Output Connectors

- B7A-R6A13
- B7A-R6A33
- B7A-R6A18
- B7A-R6A38

#### Input Module

- C200H-ID215
- C200H-MD115 (Input side only)
- C200H-MD215 (Input side only)

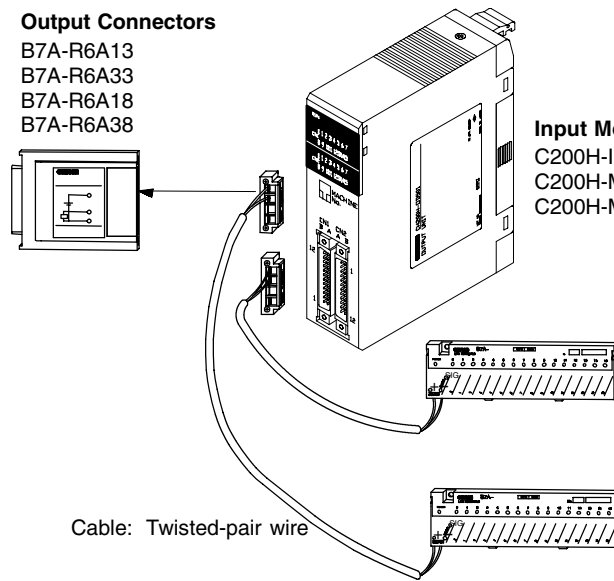

Cable: Twisted-pair wire

#### Input Blocks

- B7A-T6A1
- B7A-T6B1
- B7A-T6C1
- B7A-T6A6
- B7A-T6B6
- B7A-T6C6

### 32 and 64-point Modules

#### Output Connectors

- B7A-R3A13
- B7A-R3A33
- B7A-R3A18
- B7A-R3A38

#### Input Module

- C200H-ID216
- C200H-ID217

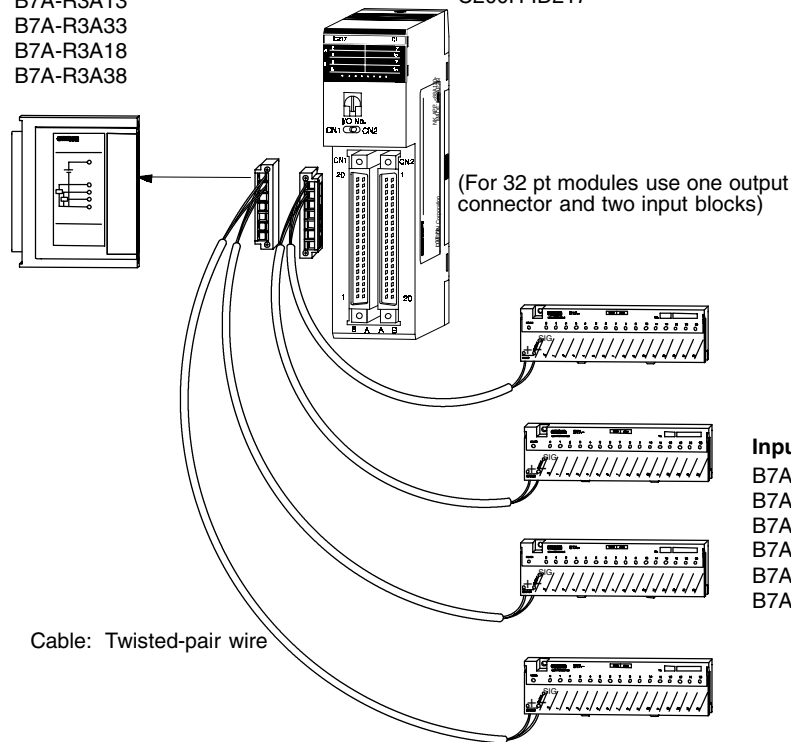

Cable: Twisted-pair wire

#### Input Blocks

- B7A-T6A1
- B7A-T6B1
- B7A-T6C1
- B7A-T6A6
- B7A-T6B6
- B7A-T6C6

Removeable  
Relay Module

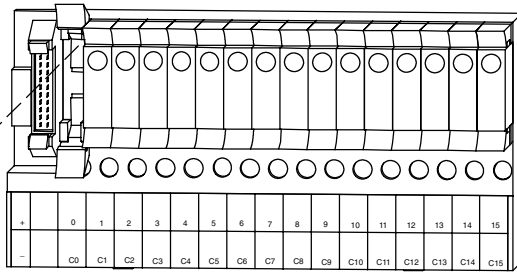

G7TC-I

## General Information

Input Blocks connect to Omron's high-density input modules or G71 SYSMAC BUS or wired remote I/O stand-alone slaves. Using the Blocks with High-density Input Modules saves Rack space and reduces total system cost. The Block and Slave combination is a cost effective distributed control system when dealing with a small number of input points at a given location. Both applications provide fully isolated input points.

## Features

- ◆ Mix and match input modules, either AC or DC relay and SSR
- ◆ Blocks available with a wide variety of input voltages 12 VDC, 24 VDC, 110/120 VAC, and 220/240 VAC
- ◆ Modules are easily changed for flexibility and servicing
- ◆ Built-in surge suppressors and LED indicators
- ◆ Mounts easily on DIN Rail

All Remote I/O Blocks require a 24 VDC power supply. Omron recommends the S82K family of power supplies. Refer to System Configuration, for current consumption and formulas for determining the appropriate power supply requirements.

## P7TF, G7TC Input Blocks

### Specifications

Part number	P7TF-IS16-DC24V	P7TF-IS16-AC110/120V	P7TF-IS16-AC220/240V
No. of points	16	16	16
Input voltage	User-selectable	User-selectable	User-selectable
Supply voltage	24 VDC	24 VDC	24 VDC
Internal circuit	NPN (neg. com.)	NPN (neg. com.)	NPN (neg. com.)
Applicable Input Module part numbers	G7T-1122S-DC24V G3TA-IDZR02S-DC5-24V	G7T-1122S-AC110/120V G3TA-IAZR02S-AC100-240V	G7T-1122S-AC220/240V G3TA-IAZR02S-AC100-240V

### Specifications

Part number	G7TC-ID16-DC12V	G7TC-ID16-DC24V	G7TC-IA16-AC110/120V
No. of points	16	16	16
Input voltage	12 VDC	24 VDC	110-120 VAC
Supply voltage	12 VDC	24 VDC	24 VDC
Internal circuit	NPN (neg. com.)	NPN (neg. com.)	NPN (neg. com.)
Input Module part number	G7T-1122S-DC12V	G7T-1122S-DC24V	G7T-1122S-AC110/120V

### Specifications

Part number	G7TC-IA16-AC220/240V
No. of points	16
Input voltage	User-selectable
Supply voltage	24 VDC
Internal circuit	NPN (neg. com.)
Input Module part number	G7T-1122S-DC24V

### G7T and G3T Relay and SSR Input Modules for G7TC and P7TF Input Blocks

#### Specifications

Part number	G7T-1122S-DC12V	G7T-1122S-DC24V	G7T-1122S-AC110/120V
Input device	Relay	Relay	Relay
Input voltage	12 VDC	24 VDC	110–120 VAC
Input current	42 mA	21 mA	6.4–7.0 mA
ON time	15 ms	15 ms	15 ms
OFF time	15 ms	15 ms	15 ms

#### Specifications

Part number	G7T-1122S-AC220/240V	G3TA-IAZR02S-AC100/240V	G3TA-IDZR02S-DC5-24V
Input device	Relay	Transistor	Transistor
Input voltage	220–240 VAC	100–240 VAC	5–24 VDC
Input current	3.2–3.5 mA	5 mA	5 mA
ON time	15 ms	20 ms	0.5 ms
OFF time	15 ms	20 ms	0.5 ms

### 16-point Module

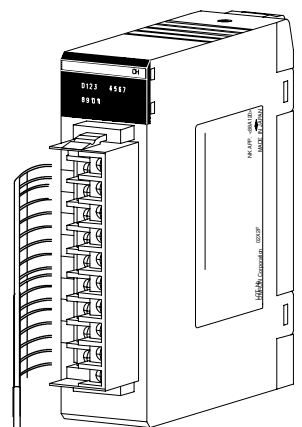

**Input Module**  
C200H-ID212  
C200H-IM212

#### Connecting Cable

- G79-Y050C
- G79-Y100C
- G79-Y150C
- G79-Y200C
- G79-Y500C

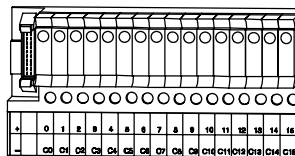

**Input Block**  
G7TC-ID16  
G7TC-IA16  
P7TF-IS16

1

**Special  
32-point Modules**

1

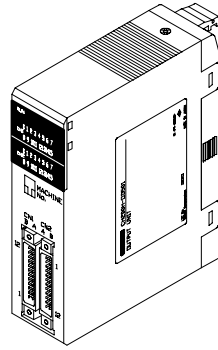

**Input Module**  
C200H-ID215  
C200H-MD215 (Input side only)

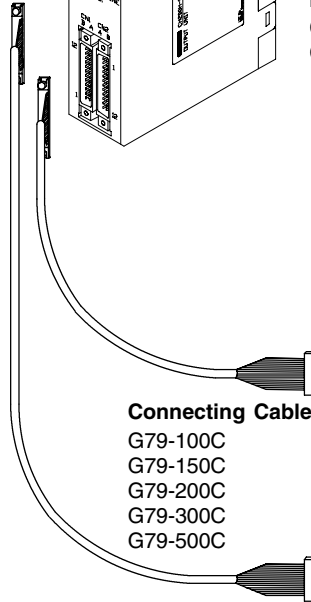

**Connecting Cables**  
G79-100C  
G79-150C  
G79-200C  
G79-300C  
G79-500C

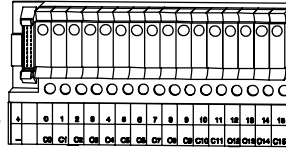

**Input Blocks**  
G7TC-ID16  
G7TC-IA16  
P7TF-IS16

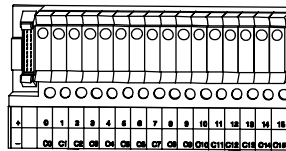

**Group 2  
32 and 64-point Modules**

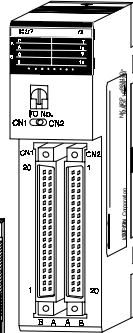

**Input Module**  
C200H-ID216  
C200H-ID217

(For 32 pt module use  
two 16 input blocks)

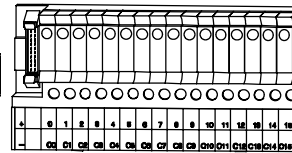
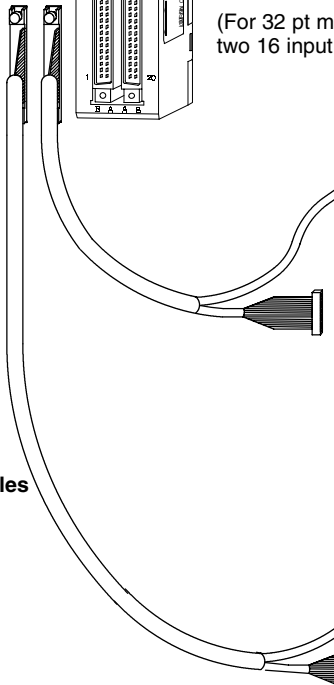

**Input Blocks**  
G7TC-ID16  
G7TC-IA16  
P7TF-IS16

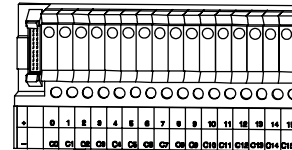
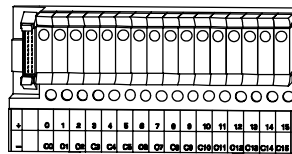

**Connecting Cables**  
G79-I100C-75  
G79-I150C-125  
G79-I200C-175  
G79-I300C-275  
G79-I500C-475

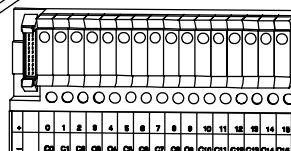

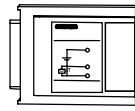

B7A-T6E3  
B7A-T6E8

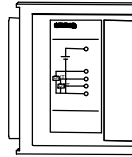

B7A-T3E3  
B7A-T3E8

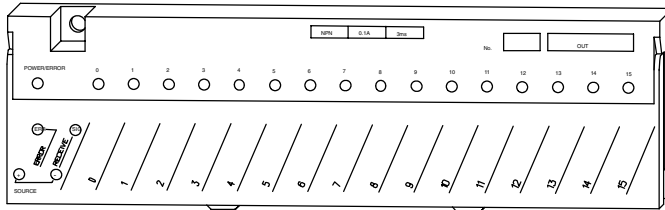

- |           |           |
|-----------|-----------|
| B7A-R6B11 | B7A-R6C11 |
| B7A-R6B31 | B7A-R6C31 |
| B7A-R6B16 | B7A-R6C16 |
| B7A-R6B36 | B7A-R6C36 |
| B7A-R6F11 | B7A-R6G11 |
| B7A-R6F31 | B7A-R6G31 |
| B7A-R6F16 | B7A-R6G16 |
| B7A-R6F36 | B7A-R6G36 |

### General Information

The B7A Input Connectors connect directly to high-density output modules. The connectors communicate to B7A output blocks in a remote location by means of only two wires. Field output devices are then wired to the output blocks. This reduces wiring between control panels while also saving space and wiring time.

### Features

- ◆ Transmit 16 output signals to high-density output modules over two wires, or 32 output signals over four wires.
- ◆ Transmission distances of 100 or 500 meters (high-speed I/O delay of 3 ms)
- ◆ Rated load of 100 mA, 5 to 24 VDC maximum per point
- ◆ Models available with 500 mA maximum per point switching capacity
- ◆ Models available with the hold function or load OFF function for signal transmission errors
- ◆ LED indicators for easy confirmation of output status and transmission errors
- ◆ Small size of 167 x 37 mm (6.57 x 1.45 in.) allows installation in small enclosures
- ◆ DIN rail or control panel mounting

### B7A 16-Point Input Connectors

#### Specifications

Part number	B7A-T6E3	B7A-T6E8
Input configuration	NPN compatible	NPN compatible
Input current range	0.6 mA to 1.5 mA	0.6 mA to 1.5 mA
Input voltage range	0 VDC to supply voltage	0 VDC to supply voltage
I/O delay	Normal-speed 19.2 ms	High-speed 3 ms

### B7A 32-Point Input Connectors

#### Specifications

Part number	B7A-T3E3	B7A-T3E8
Input configuration	NPN compatible	NPN compatible
Input current range	0.6 mA to 1.5 mA	0.6 mA to 1.5 mA
Input voltage range	0 VDC to supply voltage	0 VDC to supply voltage
I/O delay	Normal-speed 19.2 ms	High-speed 3 ms

All B7A Output Blocks require a 12- to 24-VDC power supply. Omron recommends the S82K family of power supplies. Refer to System Configuration for current consumption and formulas for determining the appropriate power supply requirements.



1

**B7A 16-point (100-mA Switching Capacity) Output Blocks**

**Specifications**

Part number	B7A-R6B11	B7A-R6B31	B7A-R6B16
Output configuration	NPN open collector	NPN open collector	NPN open collector
Rated load voltage	5 to 24 VDC	5 to 24 VDC	5 to 24 VDC
Rated load current	100 mA max./point	100 mA max./point	100 mA max./point
I/O delay	Normal-speed 19.2 ms	Normal-speed 19.2 ms	High-speed 3 ms
Internal I/O common	+ common	+ common	+ common
Error processing	Hold	Load OFF	Hold

**Specifications**

Part number	B7A-R6B36	B7A-R6F11	B7A-R6F31
Output configuration	NPN open collector	PNP open collector	PNP open collector
Rated load voltage	5 to 24 VDC	5 to 24 VDC	5 to 24 VDC
Rated load current	100 mA max./point	100 mA max./point	100 mA max./point
I/O delay	High-speed 3 ms	Normal-speed 19.2 ms	Normal-speed 19.2 ms
Internal I/O common	+ common	- common	- common
Error processing	Load OFF	Hold	Load OFF

**Specifications**

Part number	B7A-R6F16	B7A-R6F36
Output configuration	PNP open collector	PNP open collector
Rated load voltage	5 to 24 VDC	5 to 24 VDC
Rated load current	100 mA max./point	100 mA max./point
I/O delay	High-speed 3 ms	High-speed 3 ms
Internal I/O common	- common	- common
Error processing	Hold	Load OFF

**B7A 16-point (500-mA Switching Capacity) Output Blocks**

**Specifications**

Part number	B7A-R6C11	B7A-R6C31	B7A-R6C16
Output configuration	NPN open collector	NPN open collector	NPN open collector
Rated load voltage	5 to 24 VDC	5 to 24 VDC	5 to 24 VDC
Rated load current	500 mA max./point	500 mA max./point	500 mA max./point
I/O delay	Normal-speed 19.2 ms	Normal-speed 19.2 ms	High-speed 3 ms
Internal I/O common	+ common	+ common	+ common
Error processing	Hold	Load OFF	Hold

**Specifications**

Part number	B7A-R6C36	B7A-R6G11	B7A-R6G31
Output configuration	NPN open collector	PNP open collector	PNP open collector
Rated load voltage	5 to 24 VDC	5 to 24 VDC	5 to 24 VDC
Rated load current	500 mA max./point	500 mA max./point	500 mA max./point
I/O delay	High-speed 3 ms	Normal-speed 19.2 ms	Normal-speed 19.2 ms
Internal I/O common	+ common	- common	- common
Error processing	Load OFF	Hold	Load OFF

### Specifications

Part number	B7A-R6G16	B7A-R6G36
Output configuration	PNP open collector	PNP open collector
Rated load voltage	5 to 24 VDC	5 to 24 VDC
Rated load current	500 mA max./point	500 mA max./point
I/O delay	High-speed 3 ms	High-speed 3 ms
Internal I/O common	- common	- common
Error processing	Hold	Load OFF

### Special 32-point Modules

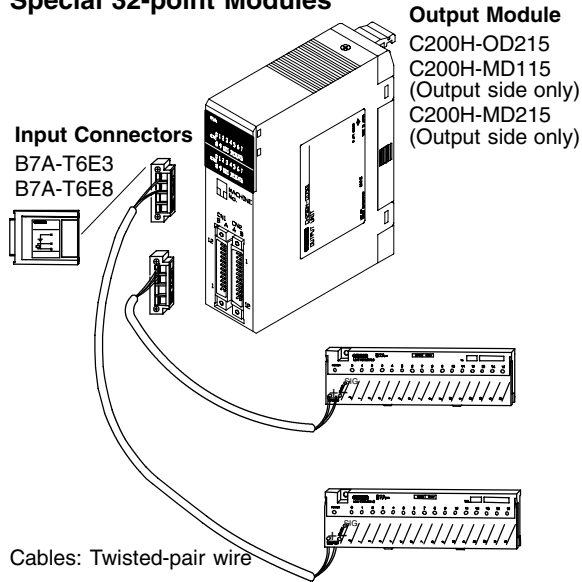

#### Output Blocks

B7A-R6B11 B7A-R6C11  
 B7A-R6B31 B7A-R6C31  
 B7A-R6F11 B7A-R6G11  
 B7A-R6F31 B7A-R6G31  
 B7A-R6B16 B7A-R6C16  
 B7A-R6B36 B7A-R6C36  
 B7A-R6F16 B7A-R6G16  
 B7A-R6F36 B7A-R6G36

### Group 2 32 and 64-point Modules

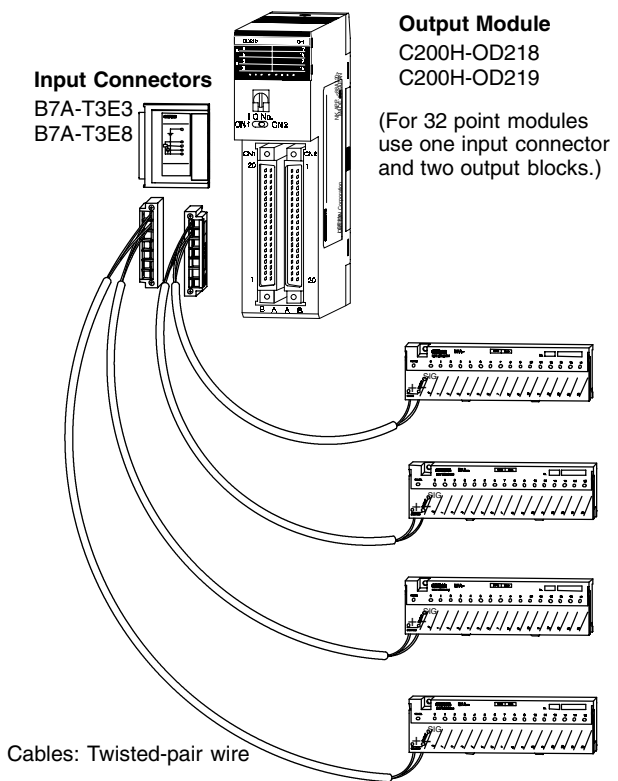

#### Output Blocks

B7A-R6B11 B7A-R6C11  
 B7A-R6B31 B7A-R6C31  
 B7A-R6F11 B7A-R6G11  
 B7A-R6F31 B7A-R6G31  
 B7A-R6B16 B7A-R6C16  
 B7A-R6B36 B7A-R6C36  
 B7A-R6F16 B7A-R6G16  
 B7A-R6F36 B7A-R6G36

1

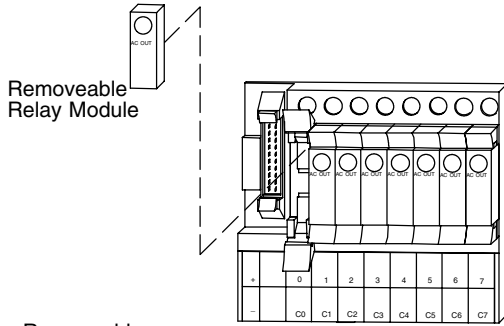

G7TC-OC08

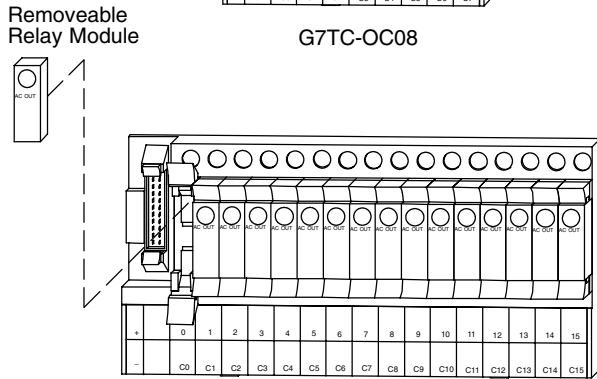

G7TC-OC16

### General Information

Output blocks connect to Omron's high-density output modules or G71 SYSMAC BUS or wired remote output stand-alone slaves. Using the blocks with high-density output modules saves rack space and reduces total system cost. The block and slave combination is a cost-effective distributed control system when dealing with a small number of output points at a given location. Both applications provide fully isolated output points with large switching capacities.

### Features

- ◆ 8 and 16-point blocks available
- ◆ Mix and match output modules, AC and DC relay or SSR isolated
- ◆ 5-A switching capacity
- ◆ Modules are easily changed for flexibility and servicing
- ◆ Built-in surge suppressers and LED indicators
- ◆ Mounts easily on DIN rail



### P7TF, G7TC Output Blocks

#### Specifications

Part number	P7TF-OS16-DC12V	P7TF-OS08-DC12V	P7TF-OS16-DC24V
No. of points	16	8	16
Switching capacity	User-selected	User-selected	User-selected
Current consumption	80 mA, 12 VDC	40 mA, 12 VDC	80 mA, 24 VDC
Internal circuit	NPN (pos. com.)	NPN (pos. com.)	NPN (pos. com.)
Applicable relay module part numbers	G7T-1112S-DC12V G7T-1012S-DC12V	G7T-1112S-DC12V G7T-1012S-DC12V	G7T-1112S-DC24V G7T-1012S-DC24V G3TA-OA202S-DC24V G3TA-ODX02S-DC24V G3TA-OD201S-DC24V

#### Specifications

Part number	P7TF-OS16-1-DC24V	P7TF-OS08-DC24V	P7TF-OS08-1-DC24V
No. of points	16	8	8
Switching capacity	User-selected	User-selected	User-selected
Current consumption	80 mA, 24 VDC	40 mA, 12 VDC	40 mA, 12 VDC
Internal circuit	PNP (neg. com.)	NPN (pos. com.)	PNP (neg. com.)
Applicable relay module part numbers	G7T-1112S-DC24V G7T-1012S-DC24V G3TA-OA202S-DC24V G3TA-ODX02S-DC24V G3TA-OD201S-DC24V	G7T-1112S-DC24V G7T-1012S-DC24V G3TA-OA202S-DC24V G3TA-ODX02S-DC24V G3TA-OD201S-DC24V	G7T-1112S-DC24V G7T-1012S-DC24V G3TA-OA202S-DC24V G3TA-ODX02S-DC24V G3TA-OD201S-DC24V

#### Specifications

Part number	G7TC-OC16-DC12V	G7TC-OC16-DC24V	G7TC-OC16-1-DC24V
No. of points	16	16	16
Max. switching current	5 A	5 A	5 A
Max. switching voltage	250 VAC, 125 VDC	250 VAC, 125 VDC	250 VAC, 125 VDC
Max. switching power	12 W, DC; 440 VA, AC	12 W, DC; 440 VA, AC	12 W, DC; 440 VA, AC
Current consumption	752 mA, 12 VDC	416 mA, 24 VDC	416 mA, 24 VDC
Internal circuit	NPN (pos. com.)	NPN (pos. com.)	PNP (neg. com.)
Relay module part number	G7T-1112S-DC12V	G7T-1112S-DC24V	G7T-1112S-DC24V

#### Specifications

Part number	G7TC-OC08-DC24V	G7TC-OC08-1-DC24V
No. of points	8	8
Max. switching current	5 A	5 A
Max. switching voltage	250 VAC, 125 VDC	250 VAC, 125 VDC
Max. switching power	12 W, DC; 440 VA, AC	12 W, DC; 440 VA, AC
Current consumption	208 mA, 24 VDC	208 mA, 24 VDC
Internal circuit	NPN (pos. com.)	PNP (neg. com.)
Relay module part number	G7T-1112S-DC24V	G7T-1112S-DC24V

1

**G7T and G3TA Relay and SSR Output Modules for G7TC and P7TF Output Blocks**

**Specifications**

Part number	G7T-1112S-DC12V	G7T-1112S-DC24V
Output type	NO Relay	NO Relay
Input voltage	12 VDC	24 VDC
Max. switching current	5 A	5 A
Max. switching voltage	250 VAC, 125 VDC	250 VAC, 125 VDC
Max. switching power	12 W, DC; 440 VA, AC	12 W, DC; 440 VA, AC
ON time	15 ms	15 ms
OFF time	15 ms	15 ms

**Specifications**

Part number	G7T-1012S-DC12V	G7T-1012S-DC24V
Output type	NC Relay	NC Relay
Input voltage	12 VDC	24 VDC
Max. switching current	5 A	5 A
Max. switching voltage	250 VAC, 125 VDC	250 VAC, 125 VDC
Max. switching power	12 W, DC; 440 VA, AC	12 W, DC; 440 VA, AC
ON time	15 ms	15 ms
OFF time	15 ms	15 ms

**Specifications**

Part number	G3TA-ODX02S-DC24V	G3TA-OD201S-DC24V
Output type	Transistor	Transistor
Input voltage	24 VDC	24 VDC
Load current	2 A	40 to 200 VDC
Load voltage	4-60 VDC	1 A
ON time	0.5 ms	2 ms
OFF time	2 ms	2 ms

**Specifications**

Part number	G3TA-OA202SZ-DC24V
Output type	Triac
Input voltage	24 VDC
Load voltage	2 A
Load current	75 to 264 VDC
ON time	1/2 of power supply cycle + 1 ms
OFF time	1/2 of power supply cycle + 1 ms

### 16-point Modules

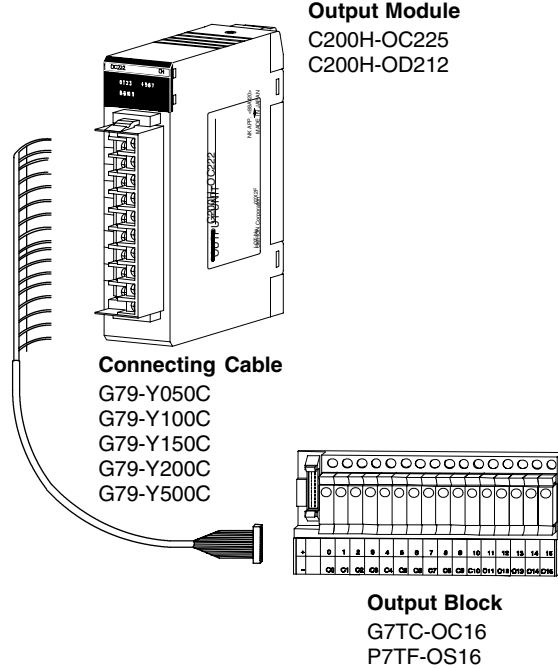

### 32-point Modules

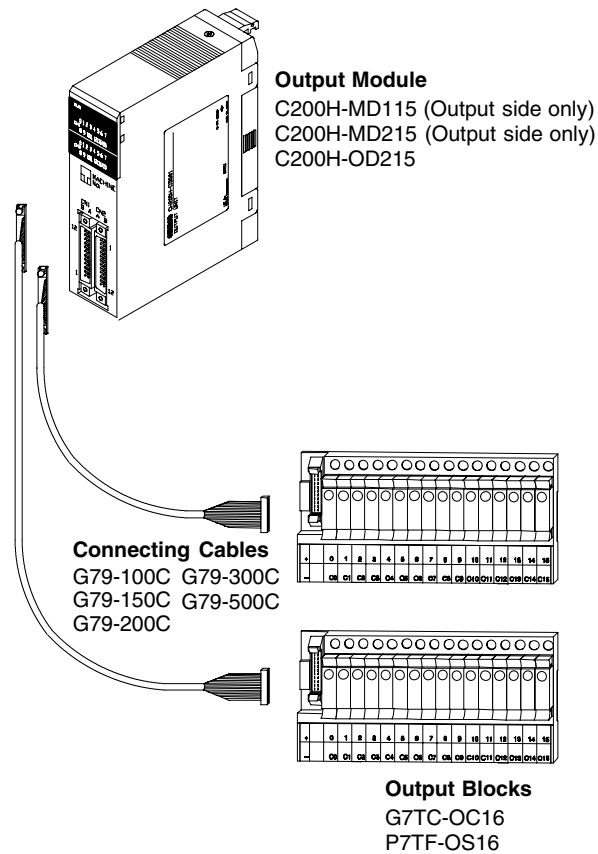

1

**Group 2**  
**32-point Modules**  
for CPU21/23/31/HS

**Output Module**  
C200H-OD218

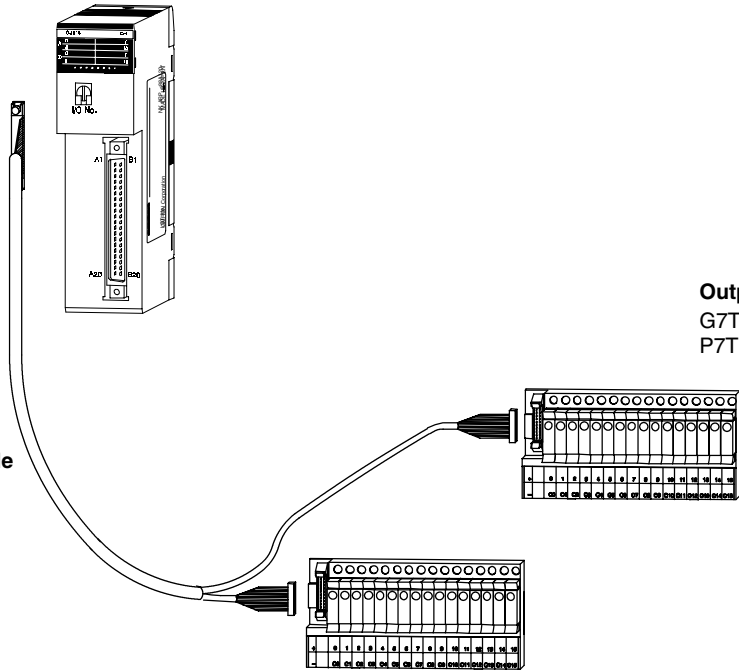

**Connecting Cable**  
G79-O100C-75  
G79-O150C-125  
G79-O200C-175  
G79-O300C-275  
G79-O500C-475

**Output Blocks**  
G7TC-OC16  
P7TF-OS16

**Group2**  
**64-point Modules**  
for CPU 21/23/31/HS

**Output Module**  
C200H-OD219

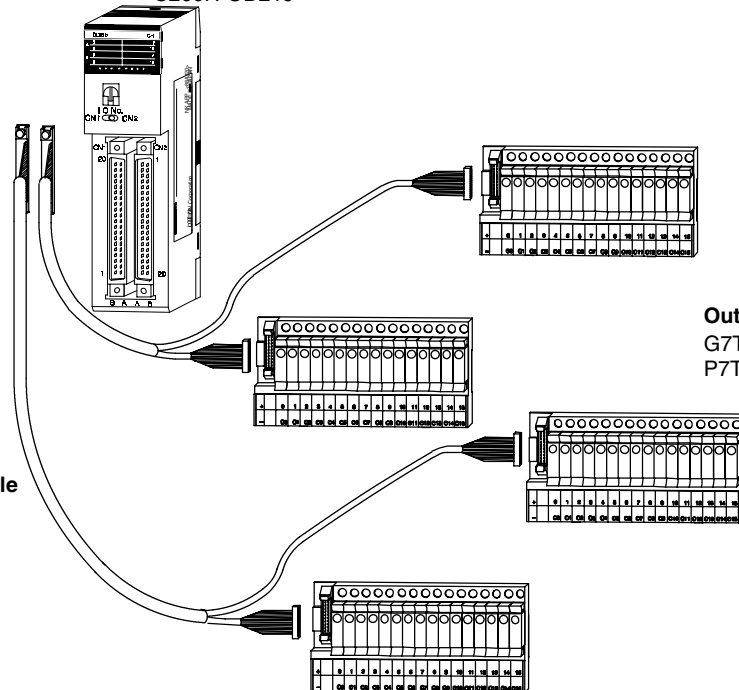

**Connecting Cable**  
G79-O100C-75  
G79-O150C-125  
G79-O200C-175  
G79-O300C-275  
G79-O500C-475

**Output Blocks**  
G7TC-OC16  
P7TF-OS16

1

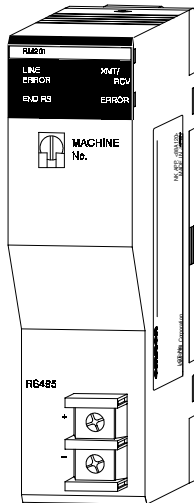

C200H-RM201

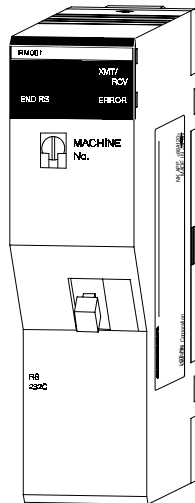

C200H-RM001

### SYSMAC BUS Remote Master Modules

The SYSMAC BUS remote master modules expand the PLC system and provide the communication interface to SYSMAC BUS remote I/O systems. Each remote master module can control several remote expansion racks including C500 remote expansion racks and C200H remote expansion racks. In addition, fiber-optic remote master modules can also control SYSMAC BUS fiber-optic remote I/O blocks. Wired remote master modules can also control SYSMAC BUS wired remote I/O blocks, analog I/O blocks, programmable terminals, and third party devices. Multiple SYSMAC BUS masters can be used in a single PLC. The modules are C200H I/O modules, and can be installed in the CPU rack or local expansion rack.

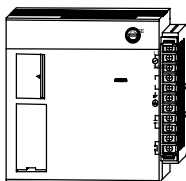

C200H-RT001-P

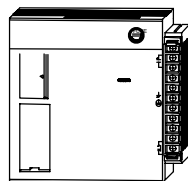

C200H-RT002-P

### SYSMAC BUS Remote Slave Modules

These remote slave modules connect C200H remote expansion racks to the SYSMAC BUS remote master module. Both fiber-optic and twisted pair versions are available. The module mounts in the right-most slot of the remote expansion rack. The power supply is also built-in. Multiple racks can be connected to a single master module.

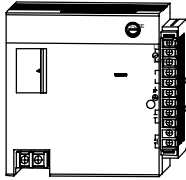

C200H-RT201

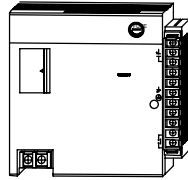

C200H-RT202

#### Remote Master Modules

Transmission media	Part number
Fiber-optic cable	C200H-RM001-P
Twisted pair conductor	C200H-RM201

#### Remote Slave/Power Supply Modules

Power Supply	Transmission media	Part number
120 VAC	Fiber-optic cable	C200H-RT001-P
24 VDC	Fiber-optic cable	C200H-RT002-P
120 VAC	Twisted pair conductor	C200H-RT201
24 VDC	Twisted pair conductor	C200H-RT202

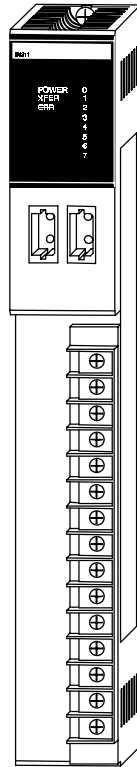

**General Information**

SYSMAC BUS fiber-optic remote I/O blocks can be connected to SYSMAC BUS fiber-optic remote I/O systems to provide a smaller number of I/O points at remote locations. Each SYSMAC BUS fiber-optic remote I/O block provides 8 input or output points.

**Features**

- ◆ Uses standard Omron fiber-optic cables and connectors
- ◆ Simple cable configuration and termination in the field

**SYSMAC BUS Fiber-optic Remote Input Blocks**

**Specifications**

Part number	3G5A2-ID001-(P)E	3G5A2-IA121-(P)E	3G5A2-IA221-(P)E
Input voltage	No-voltage contacts	100 VAC +10%/-15% 50/60 Hz	200 VAC +10%/-15% 50/60 Hz
Input impedance	—	9.7 kΩ (50 Hz) 8 kΩ (60 Hz)	22 kΩ (50 Hz) 18 kΩ (60 Hz)
Input current	10 mA typical	10 mA typical (at 100 VAC)	10 mA typical (at 100 VAC)
ON delay time	10 ms max.	10 ms max.	10 ms max.
OFF delay time	15 ms max.	15 ms max.	15 ms max.
Number of circuits	8 pts. (per common)	8 pts. (per common)	8 pts. (per common)
ON voltage	—	60 VAC min.	120 VAC min.
OFF voltage	—	20 VAC max.	40 VAC max.
Power supply voltage	120 VAC	120 VAC	120 VAC
Power consumption	25 VA max.	20 VA max.	20 VA max.

**Specifications**

Part number	3G5A2-IM211-(P)E
Input voltage	12 to 24 VAC/DC +10%/-15%
Input impedance	1.8 kΩ
Input current	10 mA typical (at 24 VDC)
ON delay time	10 ms max.
OFF delay time	15 ms max.
Number of circuits	8 pts. (per common)
ON voltage	10.2 VDC min.
OFF voltage	3.0 VDC max.
Power supply voltage	120 VAC
Power consumption	20 VA max.

### SYSMAC BUS Fiber-optic Remote Output Blocks

#### Specifications

Part number	3G5A2-OC221-(P)E	3G5A2-OD411-(P)E	3G5A2-OA222-(P)E
<b>Max. switching capacity</b>	Resistive: 2 A, 250 VAC (p.f. = 1) 2 A, 24 VDC Inductive: 0.5 A, 250 VAC (p.f. = 0.4)	0.3 A, 12 to 48 VDC +10%/15%,	1 A, 120/240 VAC +10%/-15%
<b>Min. switching capacity</b>	100 mA, 5 VDC	—	10 mA, 100 VAC
<b>Leakage current</b>	—	100 $\mu$ A max.	3 mA max. (at 100 VAC)
<b>Saturation voltage</b>	—	1.5 V max.	1.2 V max.
<b>ON delay time</b>	15 ms max.	0.2 ms max.	1 ms max.
<b>OFF delay time</b>	15 ms max.	0.3 ms max.	Max. 1/2 of load frequency
<b>Number of circuits</b>	8 pts. (per common)	8 pts. (per common)	8 pts. (per common)
<b>Service life</b>	Electrical: 300,000 operations (resistive load) 100,000 operations (inductive load) Mechanical: 50,000,000 operations	—	—
<b>Fuse capacity</b>	—	—	250 V, 5 A
<b>Power supply voltage</b>	120/240 VAC	120/240 VAC	120/240 VAC
<b>Power consumption</b>	20 VA max.	20 VA max.	20 VA max.

1

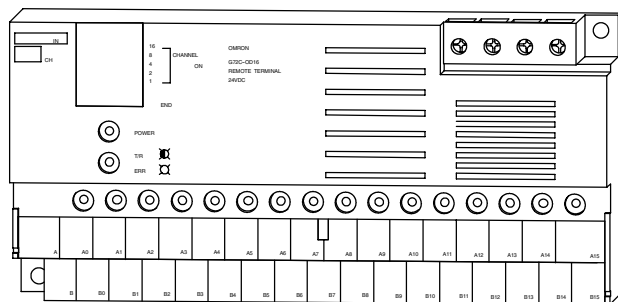

G72C-ID16-DC24V  
G72C-OD16-DC24V

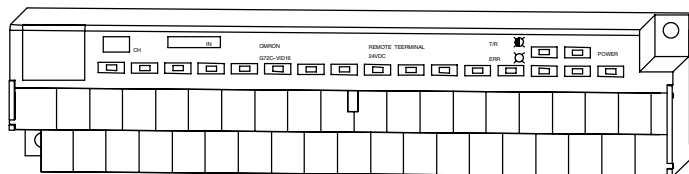

G72C-VID16-DC24V  
G72C-VOC16-DC24V

## General Information

The remote I/O blocks integrate the functions of the remote I/O stand-alone slave and the I/O block. The remote I/O blocks connect to SYSMAC BUS wired remote I/O systems.

## Features

- ◆ Cost-effective distribution to 16 I/O points
- ◆ LED indicators for power, transmission, errors, and I/O status
- ◆ DIN Rail or control panel mounting

## Specifications – Input

Part number	G72C-ID16-DC24V	G72C-VID16-DC24V
Points	16 (8/com.)	16 (16/com.)
Required supply voltage	200 mA, 24 VDC	200 mA, 24 VDC
Internal circuit	NPN (pos. com.)	NPN (pos. com.)
Device	Transistor	Transistor
Input current	9.7 mA/pt.	9.7 mA/pt.
Input voltage	24 VDC	24 VDC
ON time	1.5 ms	1.5 ms
OFF Time	1.5 ms	1.5 ms

## Specifications – Output

Part number	G72C-OD16-DC24V	G72C-VOD16-DC24V
Points	16 (8/com.)	16 (16/com.)
Switching capacity	0.3 A/pt., 24 VDC	0.3 A/pt. (2.4 A total), 24 VDC
Required supply voltage	200 mA, 24 VDC	200 mA, 24 VDC
Internal circuit	NPN (pos. com.)	NPN (neg. com.)
Device	Transistor	Transistor

All Remote I/O Blocks require a 24 VDC power supply. Omron recommends the S82K family of power supplies.



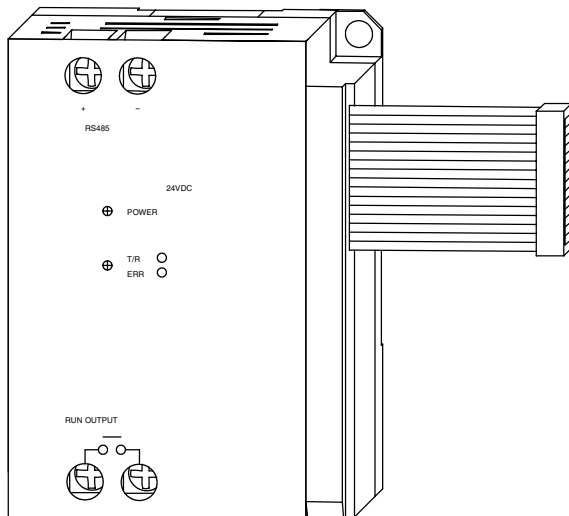

### General Information

Remote I/O stand-alone slaves connect to SYSMAC BUS wired remote I/O systems. The remote stand-alone slave connects directly to I/O blocks.

### Features

- ◆ Remote I/O stand-alone slave and block combinations offer flexible system design
- ◆ Compatible with C-series and CV-series PLCs
- ◆ Can be located closer to field I/O devices, effectively reducing wiring costs, and lowering the cost of the distributed control system
- ◆ LED indicators for power, transmission, and errors
- ◆ DIN rail or control panel mounting



### Specifications – Input

Part number	<b>G71-IC16-DC24V</b>
Points	16 (8/com.)
Input voltage	24 VDC
Input current	6.7 mA/pt.
ON time	9 ms, max.
OFF time	14.5 ms, max.
ON voltage	15 VDC, max.
OFF voltage	5.6 VDC, max.
Internal circuit	NPN (pos. com.)

### Specifications – Output

Part number	<b>G71-OD16-DC24V</b>
Points	16 (8/com.)
Input voltage	24 VDC
Output current	30 mA/pt.
Residual voltage	1.2 V, max.
Leakage current	100 $\mu$ A, max.
Internal circuit	NPN (neg. com.)

### Specifications

	<b>G71-IC16-DC24V</b>	<b>G71-OD16-DC24V</b>
Applicable I/O Blocks	G7TC-IA16, G7TC-ID16, P7TF-IS16	G7TC-OC16, G7TC-OC08, P7TF-OS16, P7TF-OS08

All Remote I/O blocks require a 24 VDC power supply. Omron recommends the S82K family of power supplies.

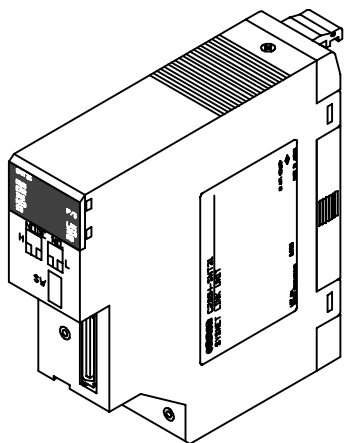

C200HS-SNT32

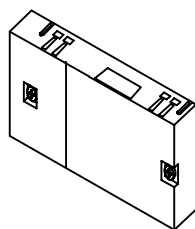

C200H-CE001

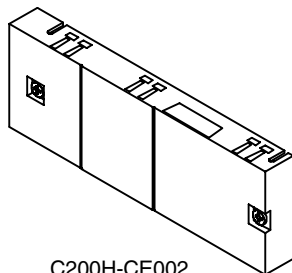

C200H-CE002

## General Information

The C200HS-SNT32 SYSMAC NET interface module connects the PLC to Omron's fiber-optic token ring LAN. A direct connection to the dual media, automatic loopback fiber-optic network is provided on the front of the module. An external power supply connection provides a pass through communications option in case of PLC or module failure.

## Features

- ◆ Direct fiber-optic dual media connection in a single module
- ◆ External indicators for operating mode and diagnostics
- ◆ External power supply connection for pass through communications

## Specifications

<b>Part number</b>	<b>C200HS-SNT32</b>
<b>Number of modules per PLC</b>	2 maximum with C200H-CPU31-E or C200HS-CPU31-E
<b>Module mounting location</b>	rack, right two slots
<b>Module type</b>	Special I/O module
<b>Communication styles</b>	SEND, RECEIVE
<b>Datagram service</b>	Automatic peer-to-peer
<b>Data link</b>	
<b>Datagram size</b>	2k bytes maximum per command
<b>Data link size</b>	3,854 words maximum
<b>SYSMAC NET connection</b>	Two Omron S3200-COCH62M fiber-optic connectors
<b>Fiber-optic cable</b>	Omron HPCF, PCF
<b>External rotary switches</b>	Set unit address and node address
<b>External indicators</b>	RUN, power supply, error, communication detect, data
<b>RAS (reliability, assurance, safety) functions:</b>	Automatic loopback, node bypass (with external power supply), internode tests, watchdog timer, CRCCITT error detection, error log
<b>Required connectors</b>	One module: C200H-CE001; two modules: C200H-CE002
<b>Manual</b>	W114

Refer to this catalog for information about SYSMAC NET fiber-optic token ring LAN and the network functionality, performance, and configuration.

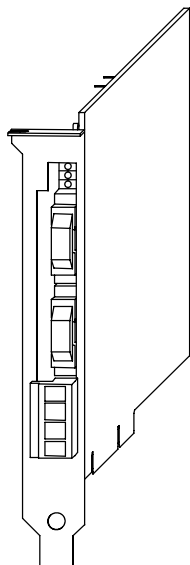

S3200-NSB11-E

### General Information

The S3200-NSB11-E network support board is an ISA bus computer interface card for SYSMAC NET. The network support board provides high-speed, high-capacity communications between computers linked to a SYSMAC NET network and the PLCs on that network. The board can be used as a high-speed interface for third party software allowing communications at speeds more than one hundred times faster than average serial communication. Fiber-optic communications allow high noise immunity and reliable transfer of data between PLCs and computers.

1

### Features

- ◆ High-speed data transfer between PLCs and personal computers
- ◆ Redundant fiber-optic communications - 2 independent loops
- ◆ Automatic loopback

### Specifications

<b>Part number</b>	<b>S3200-NSB11-E</b>
<b>Data transmission speed</b>	2 Mbps
<b>Distance between nodes</b>	1 km max.
<b>Number of nodes</b>	126 per network
<b>Message length</b>	2 K bytes maximum per message
<b>Bus type</b>	ISA (IBM PC/AT)
<b>Media</b>	200 micron fiber-optic cable
<b>Number of boards per computer</b>	One
<b>External connection</b>	External back-up power source

## SYSMAC NET Servers

S3200-LUS03-01E,  
S3200-NSUA1-00E,  
S3200-NSUG4-00E

# Communication Modules

1

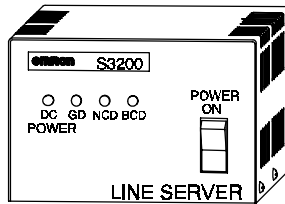

### Line Server: S3200-LSU03-01E

The S3200-LSU03-01E Line Server is responsible for monitoring the health of the network. The line server provides the token and maintains the network, and coordinates the loopback functionality of the SYSMAC NET network. Additional line servers used as repeaters in situations where distances greater than 1 km are required.

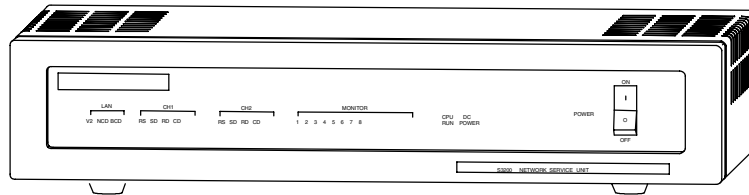

### Network Service Unit: S3200-NSUA1-00E

The S3200-NSUA1-00E Network Service Unit is used to connect serial communication devices to the SYSMAC NET network. The unit converts between serial and fiber-optic signals, allowing intelligent devices such as mainframe computers, robots, CNC machines, or bar code systems access to other devices on the network. The unit is available with two RS-232C ports or one RS-232C and one RS-422 port. Synchronous or asynchronous communication may be selected at speeds of 1200 to 9600 baud.

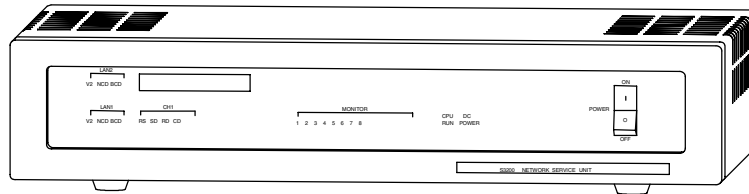

### Local Bridge: S3200-NSUG4-00E

The S3200-NSUG4-00E Local Bridge is used to inter-connect two individual SYSMAC NET loops. The bridge allows nodes on separate SYSMAC NET loops to communicate. Each loop can support up to twenty bridges.

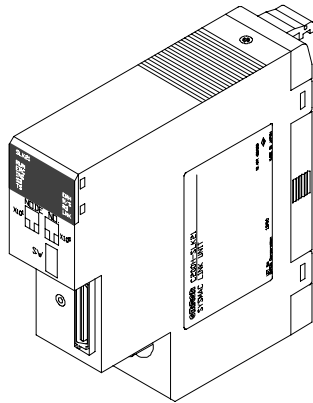

C200HS-SLK12

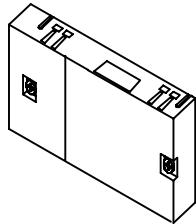

C200H-CE001

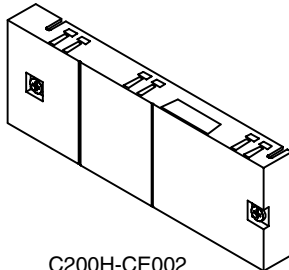

C200H-CE002

### General Information

The C200HS-SLK12 SYSMAC LINK fiber-optic module connects the PLC to the SYSMAC LINK fiber-optic token bus peer-to-peer communications network. An external power supply option provides direct pass-through communications in case of module or PLC failure.

### Features

- ◆ Direct fiber-optic connection
- ◆ Back-up power supply connection for pass-through communications
- ◆ Token bus with floating master for reliability and network integrity
- ◆ External indicators for operating mode and diagnostics

### Specifications

<b>Part number</b>	<b>C200HS-SLK12</b>
<b>Number of modules per PLC</b>	2 maximum with C200H-CPU31-E or C200HS-CPU31-E (including co-axial and fiber-optic modules)
<b>Module mounting location</b>	CPU rack, right two slots
<b>Module type</b>	Special I/O Module
<b>Communication styles</b>	
<b>CPU bus link bits</b>	Error, set up, status, and error indication
<b>Data read/write</b>	SEND, RECEIVE, DELIVER commands
<b>Automatic and manual data link</b>	Peer-to-peer
<b>Data read/write size</b>	512 bytes maximum per command
<b>Data link size</b>	2,966 words per network 918 words with a C200H connected
<b>Data link words per node</b>	254 CIO and 254 DM words maximum
<b>SYSMAC LINK connection</b>	2 - Omron S3200-COCF201 1 Fiber-optic Connectors
<b>External rotary switches</b>	Set unit address and node address
<b>External indicators</b>	RUN, power supply, communication error, PLC error, communication detect, polling Module, transfer, receive, test, Data Link
<b>External connector</b>	RJ11 for C1000H-APS01 Auxiliary Power Supply
<b>RAS (reliability, assurance, safety) functions</b>	Automatic polling Module backup, self diagnostics, watchdog timer, CRCCITT error detection, error log
<b>Required connectors</b>	One module: C200H-CE001; two modules: C200H-CE002
<b>Manual</b>	W174

Refer to this catalog for information about SYSMAC LINK Token Bus functionality, performance, and configuration.

1

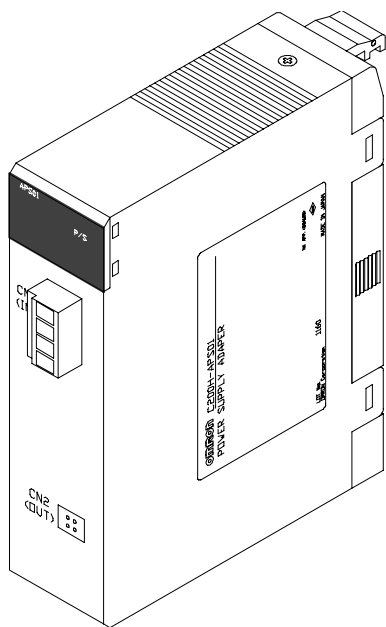

C200H-APS01

### General Information

The C200H-APS01 auxiliary power supply provides back-up power to the SYSMAC LINK fiber-optic interface module in case of module or PLC failure. The power supply provides pass-through communications capability allowing the rest of the Network to function normally.

### Features

- ◆ Provides an auxiliary power source for two SYSMAC LINK fiber-optic modules
- ◆ Provides pass-through communications for added reliability
- ◆ Ready-made cables for easy connection to the SYSMAC LINK modules

### Specifications

<b>Part number</b>	<b>C200H-APS01</b>
<b>Number of modules supported</b>	Two fiber-optic SYSMAC LINK
<b>Input voltage</b>	100 to 120 or 200 to 240 VAC
<b>Operating voltage range</b>	85 to 132 or 170 to 264 VAC
<b>External connections</b>	Back-up AC power terminals, 2 power supplies
<b>External indicators</b>	Power supply indicator lit when AC power is supplied
<b>Cable</b>	RJ11 from power supply to C200H-SLK11; two included
<b>Mounting location</b>	Power supply mounted next to SLK11 module
<b>Manual</b>	W212

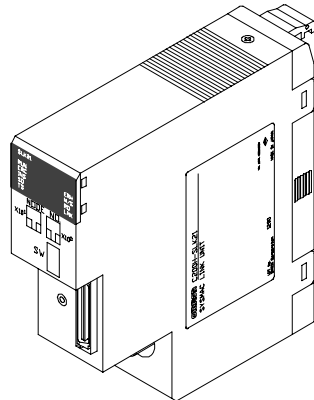

C200HS-SLK22

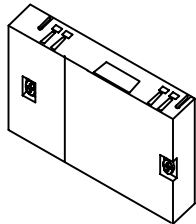

C200H-CE001

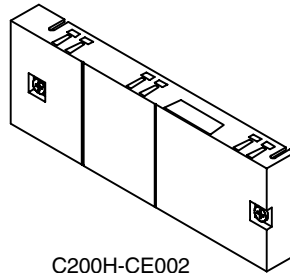

C200H-CE002

### General Information

The C200HS-SLK22 SYSMAC LINK module connects the PLC to the SYSMAC LINK token bus peer-to-peer communications network. A pass through coaxial cable connection is provided on the front of the module.

### Features

- ◆ Co-axial cable pass-through connection
- ◆ Token Bus with floating master provides network integrity and reliability
- ◆ External indicators for operating mode and diagnostics

1

### Specifications

<b>Part number</b>	<b>C200HS-SLK22</b>
<b>Number of modules per PLC</b>	2 maximum with C200H-CPU31-E or C200HS-CPU31-E (including co-axial and fiber-optic modules)
<b>Module mounting location</b>	CPU rack
<b>Module type</b>	Special I/O module
<b>Communication styles</b>	
<b>CPU bus link bits</b>	Error, set up, status, and error indication
<b>Data read/write</b>	SEND, RECEIVE, DELIVER commands
<b>Automatic and manual data link</b>	peer-to-peer
<b>Data read/write size</b>	512 bytes maximum per command
<b>Data link size</b>	2,966 words per network 918 words with a C200H connected
<b>Data link words per node</b>	254 CIO and 254 DM words maximum
<b>SYSMAC LINK connection</b>	BNC coaxial connectors to Omron F connector
<b>External rotary switches</b>	Set unit address and node address
<b>External indicators</b>	RUN, power supply, communication error, PLC error, communication detect, polling module, transfer, receive, test, data link
<b>RAS (reliability, assurance safety) functions</b>	Automatic polling module backup, self diagnostics, watchdog timer, CRCCITT error
<b>Required connectors</b>	One module: C200H-CE001; two modules: C200H-CE002
<b>Manual</b>	W174

Refer to this catalog for information about SYSMAC LINK Token Bus functionality, performance, and configuration.

1

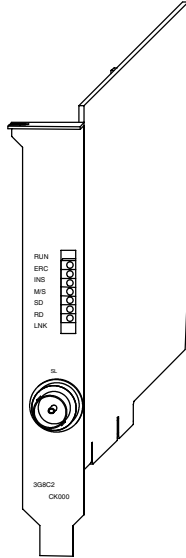

3G8F5-SLK21-E

### General Information

The 3G8F5-SLK21-E SYSMAC LINK support board is an ISA bus computer interface card for SYSMAC LINK. The board provides high-speed, high-capacity communications between computers linked to a SYSMAC LINK network and the PLCs on that network. The board can be used as a high-speed interface for third party software allowing communications at speeds more than one hundred times faster than average serial communication.

### Features

- ◆ High-speed data transfer between PLCs and personal computers
- ◆ Distributed control with data link

### Specifications

<b>Part number</b>	<b>3G8F5-SLK21-E</b>
<b>Data transmission speed</b>	2 Mbps
<b>Message length</b>	512 bytes max.
<b>Media</b>	Co-axial cable
<b>Bus type</b>	ISA (IBM PC/AT)
<b>Data link words</b>	2966 words max., 918 max. with C200H in Data Link
<b>Link functions</b>	Data Link read/write service



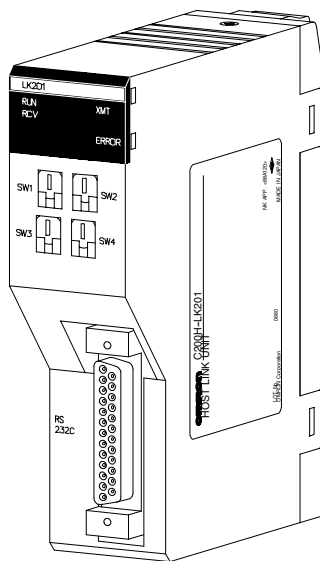

C200H-LK201-V1

### General Information

Host Link allows any computer to communicate to a single (RS-232C), or multiple (RS-422) Omron PLCs. Multiple system levels can be connected to the same PLC with up to 32 PLCs connected to one computer. Omron's Host Link protocol is well-defined and available for custom software driver development and operator interface connection to Omron PLCs. Most major operator interface companies have Host Link interfaces and drivers available. Host Link systems allow using Omron's Ladder Support Software (LSS) to program and monitor any PLC in the system.

The Host Link protocol is common to all Omron PLCs including the C20, K-type, Block-style H-type, CQM1, C200H, C1000H, C2000H, and CV-series PLCs.

### Features

- ◆ Up to 32 PLCs can be connected to a single host computer
- ◆ Twisted pair or fiber-optic transmission media

### Specifications

<b>Number of modules per PLC</b>	2 max.
<b>Module mounting location</b>	CPU rack or expansion rack
<b>Module type</b>	Special I/O module
<b>Communication ports</b>	1 RS-232C, 25 pin female (C200H-LK201) 1 RS-422 (C200H-LK202) 1 fiber port (C200H-LK101-P)
<b>Communication method</b>	Half or full duplex
<b>Band rate</b>	300, 600, 1200, 2400, 4800, 9600, 19,200 or 38,400 bps (switch-selectable)
<b>Stop bits</b>	1 or 2
<b>Parity</b>	Even, odd
<b>Data bits</b>	ASCII (7 bits) or JIS (8 bits)
<b>CT's signal control</b>	X on X off control
<b>Retry on interrupted transmission</b>	Transmission delay time setting 0 to 510 ms
<b>Front panel indicators</b>	Run, error, send, receive
<b>Manual</b>	W143

1

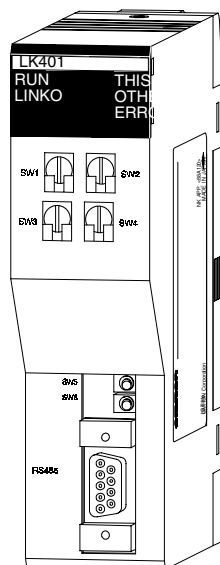

C200H-LK401

### General Information

PC Link is a peer-to-peer communication system allowing high-speed transfer of data between PLCs over long distances. Both small and large rack PLCs can be connected to the same system. Standard link adapters are available for fiber-optic media and longer transmission distances. No special programming is required to transfer data and multi-level systems can be connected to a single PLC.

### Features

- ◆ High-speed data transfer between up to 32 PLCs
- ◆ No special programming required
- ◆ Multi-level capability

### Specifications

<b>Part number</b>	<b>C200H-LK401</b>					
<b>Communication method</b>	Peer-to-peer					
<b>Network topology</b>	Multi-drop using Omron link adapters					
<b>Number of nodes</b>	PLC of polling link	Single-level	Multilevel			
	C200H, C1000H, C2000H	32	16			
	C500	8	8			
<b>Transmission media</b>	Twisted pair; fiber-optic when using Omron link adapters					
<b>Distance</b>	500 m (1640 ft) total cable length (without fiber-optic links), including branch lines Distances can be extended using link adapters					
<b>Transmission speed</b>	128 kbps					
<b>Protocol</b>	Omron PC Link, RS-485					
<b>PLC interfaces</b>	C200H, C500, C1000H, C2000H					
<b>Data transfer capacity (bits/node)</b>	PLC of polling link	2 links	3-4 links	5-8 links	9-16 links	17-32 links
	C200H, C1000H, C2000H	512	256	128	64	32
	C500	256	128	64	—	—
<b>Diagnostic functions</b>	CPU watchdog timer, CRC transmission error check					
<b>Manual</b>	W135					

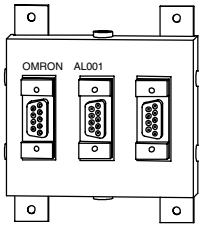

### 3G2A9-AL001

The 3G2A9-AL001 Link Adapter is used to branch cable for RS-422 cable drops to linkable modules. This adapter can be used for SYSMAC WAY Host Link or any other linkable modules.

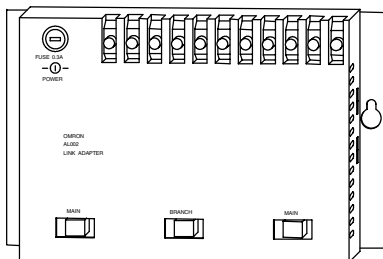

### 3G2A9-AL002-E/AL002-PE

The 3G2A9-AL002 Link Adapters are used to branch for drops to linkable PLC Modules using fiber-optic cable.

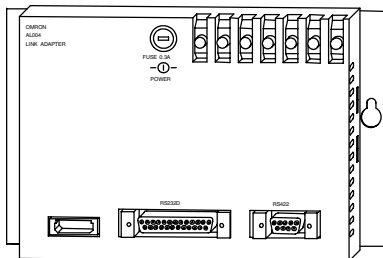

### 3G2A9-AL004-E/AL004-PE

The 3G2A9-AL004 Link Adapters are used to convert RS-232C or RS-422 to fiber-optic cable. This adapter can be used to convert an RS-232C port from a computer to RS-422 or fiber-optic cable.

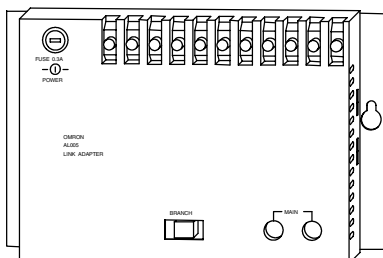

### 3G2A9-AL005-E/AL005-PE

The 3G2A9-AL005 Link Adapters are used to convert between plastic fiber-optic Cable (APF or PCF) and glass crystal fiber-optic cable (AGF).

1

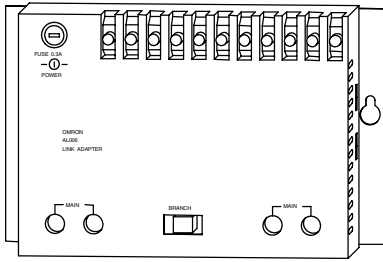

**3G2A9-AL006-E/AL006-PE**

The 3G2A9-AL006 Link Adapters are used to convert between plastic fiber-optic Cable (APF or PCF) and glass crystal fiber-optic cable. The adapter also has an extra branch for a glass crystal fiber-optic cable drop.

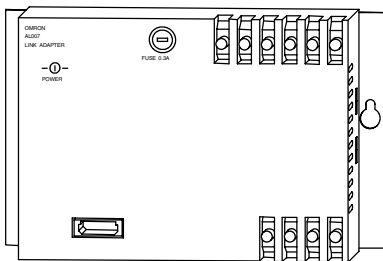

**B500-AL007-P**

The B500-AL007-P Link Adapter is used to convert between fiber-optic cable and RS-485. This adapter is used for SYSMAC BUS wired remote I/O systems only.

# 9 System Configuration

Overview .....	106
CPU Rack .....	107
CPU Rack, Local Expansion Racks .....	108
Configuring Remote I/O Systems .....	109
Configuring SYSMAC BUS Fiber-optic Remote I/O Systems ..	110
Configuring SYSMAC BUS Wired Remote I/O Systems .....	112
Configuration Summary Tables .....	114
Current Consumption .....	116
System Configuration Worksheets .....	124
Dimensions .....	129

## General Information

The System Configuration section describes the various PLC system configurations possible and assists in selecting the necessary components to complete a required parts list. Specific details about configuring PLC systems are described throughout the section. System Configuration Worksheets have also been provided to simplify the configuration and parts selection. Some basic control system application information is required in order to select the proper components.

- ◆ Number of I/O
- ◆ Type of I/O: discrete, analog, special I/O, interrupt and communications
- ◆ Distribution of I/O: Local or remote I/O requirements, location of I/O and number of I/O required at each location
- ◆ Communication system requirements
- ◆ Man-machine interface requirements

There are several system configurations that are possible with the C200H system. The following paragraphs briefly describe the types of possible C200H system configurations.

Additional configuration and technical information can be found in the detailed product manuals. Refer to Section 6 of this catalog for a list of publications.

## Local I/O Systems

Local I/O System configurations are designed to accommodate large amounts of I/O that are located within 12 meters (39 ft.) of the CPU Rack. The CPU rack can be expanded with two additional racks to accommodate large amounts of I/O. Several different configurations are possible depending on the distance and I/O requirements of the system.

- ◆ CPU Rack only
- ◆ CPU Rack and Local Expansion Racks

## Remote I/O Systems

Remote I/O systems are used in applications requiring I/O to be located at long distances from the CPU. In a C200H system, remote I/O are counted separately from local I/O, allowing expansion up to 512 remote I/O points. Multiple remote I/O systems can be added to a single PLC for additional configuration flexibility. These systems are available in fiber-optic and wired (twisted pair) versions. This section includes configuration information for the following:

- ◆ SYSMAC BUS Fiber-optic Remote I/O System
- ◆ SYSMAC BUS Wired Remote I/O System

### General Information

The following configurations describe the guidelines for building a system from the components listed in the Standard Parts section.

### Features

- ◆ 3-, 5-, 8-, or 10-slot CPU racks
- ◆ CPUs with 120/240 VAC or 24 VDC power supplies
- ◆ RAM, EPROM, or EEPROM memory available
- ◆ 3-, 5-, 8-, or 10-slot expansion I/O racks
- ◆ Up to two local expansion I/O racks can be added with I/O connecting cables for a maximum of 880 I/O

### CPU Rack

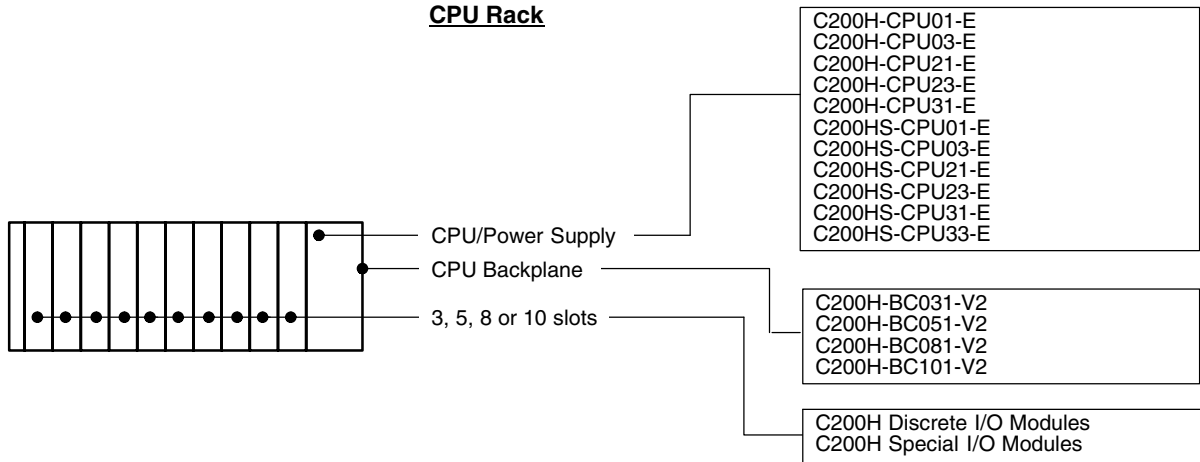

### General Information

Use this configuration when:

- ◆ Connecting up to 2 local expansion racks.
- ◆ Up to 880 local remote I/O are allowed.

#### CPU Rack

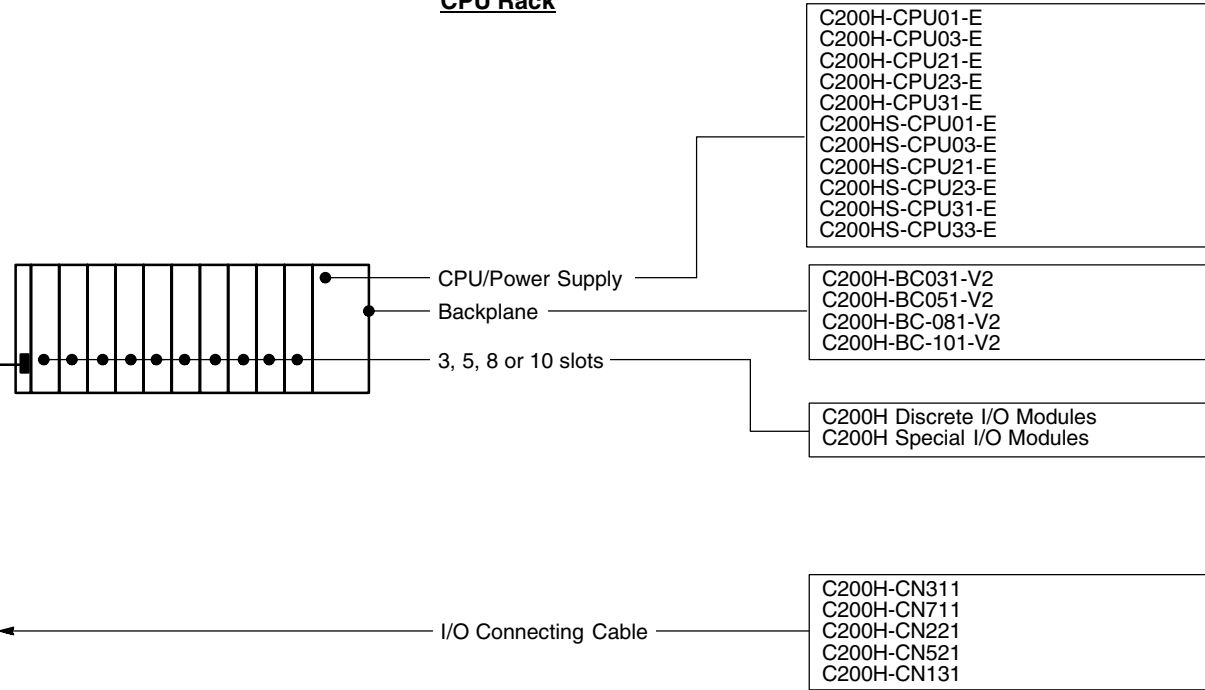

#### C200H Local Expansion Rack (2 Racks max.)

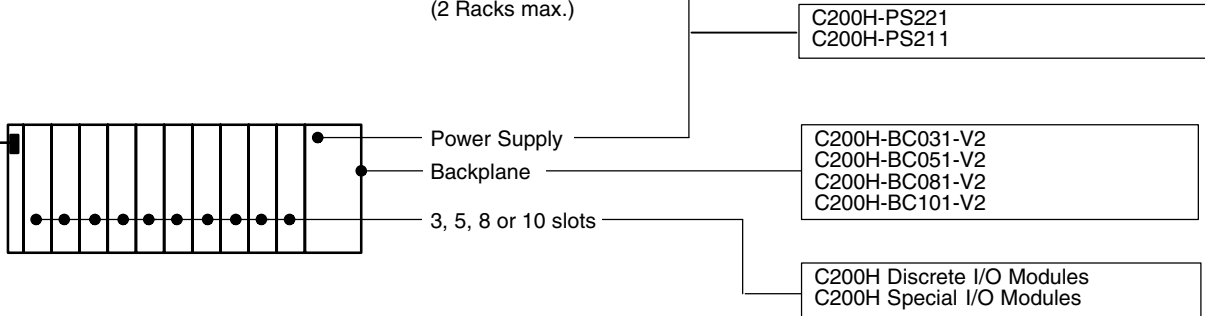



## Configuring C200H Remote I/O Systems

There are a number of guidelines to be followed when configuring remote I/O for a C200H PLC system. Because Omron offers a true family of PLCs, C200H can use expansion I/O racks and I/O modules from C500 large-rack style PLC's as well as C200H style racks and I/O modules. Two SYSMAC BUS fiber-optic or wired remote I/O systems can be added to a C200H PLC. The following tables provide guidelines and limits that must be considered when adding remote I/O systems to a PLC.

### SYSMAC BUS Remote I/O System

Multiple SYSMAC BUS remote I/O systems can be added to a C200H PLC. These general guidelines must be followed:

<b>Max. masters per PLC</b>	2 fiber or wired
<b>Max. remote expansion racks per master</b>	5 (5 remote racks per PLC max., regardless of number of masters)
<b>Max. I/O points (words) per master</b>	512 (32 words)
<b>Max. points per PLC</b>	512
<b>Distances</b>	Wire: 200 m (656 ft.) total distance APF Fiber: 20 m (65 ft.) between nodes PCF Fiber 200 m (656 ft.) between nodes HPCF Fiber 100 m (328 ft.) between nodes

### Configurations

The following pages provide additional configuration information for:

- SYSMAC BUS fiber-optic remote I/O systems
- SYSMAC BUS wired remote I/O systems

For additional information regarding configuring, extended distances, addresses and general information, refer to the following manual:

<b>SYSMAC BUS Remote I/O Manual</b>	W120
-------------------------------------	------

**General Information**

The following information can be used to configure SYSMAC BUS fiber-optic remote I/O systems connected to a PLC. Multiple remote I/O systems may be added to a single PLC. A fiber-optic remote I/O system consists of a remote master module, remote expansion racks, and Remote I/O devices, and fiber-optic cable and connectors.

**Remote Master Module**

Each remote I/O subsystem has a master module that is mounted in the CPU or local expansion rack.

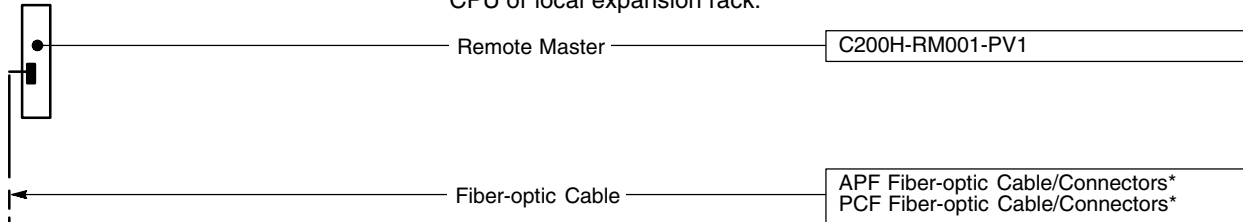

**C500 Remote Expansion Racks**

Up to 2 C500 Remote Expansion Racks can be connected to a single Remote Master Module.

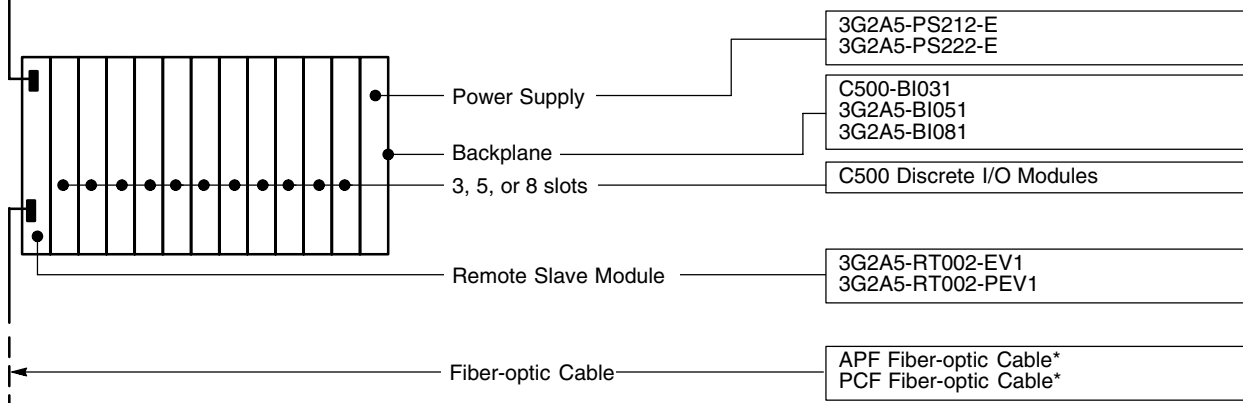

**C200H Remote Expansion Racks**

Up to 5 C200H Remote Expansion Racks can be connected to a single Remote Master Module.

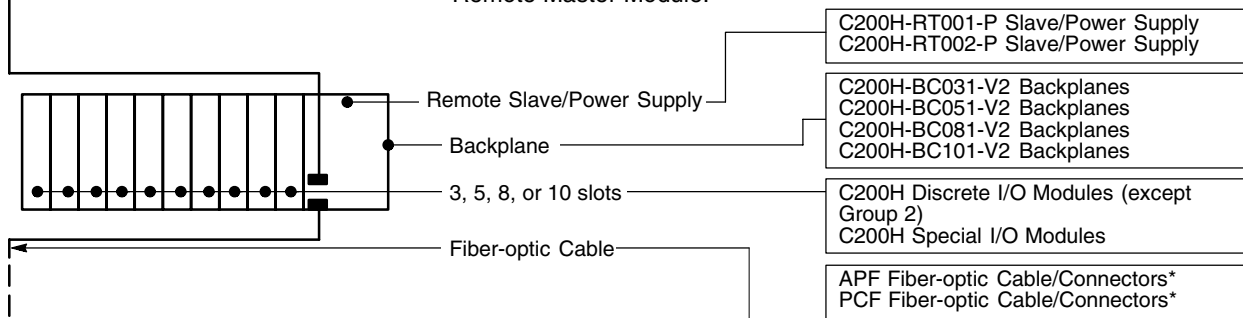

**Remote I/O Devices**

Other Remote I/O Devices can be connected to SYSMAC BUS Fiber-optic Remote I/O Systems. These include the following:

- SYSMAC BUS Fiber-optic Remote I/O Blocks

When Configuring a SYSMAC BUS fiber-optic remote I/O system:

- ◆ A total of 32 words (512 bits) can be connected to a single Remote master.
- ◆ The following table indicates the number of I/O allowed for each Remote expansion rack and I/O device.

	No. of words	No. of I/O points
<b>C500 Remote Expansion Racks</b>	Depends on I/O Modules mounted*	
<b>C200H Remote Expansion Racks</b>	Depends on I/O Modules mounted*	
<b>Fiber-optic Remote I/O Blocks</b>	1 (0.5)*	8

\*Refer to the SYSMAC BUS Remote I/O System Manual (Cat. No. W120) for additional configuration information.

**General Information**

The following information can be used to configure SYSMAC BUS wired remote I/O systems connected to a PLC. Multiple remote I/O systems may be added to a single PLC. A wired remote I/O system consists of a remote master module, remote expansion racks, and remote I/O devices, and wire.

**Remote Master Module**

Each remote I/O subsystem has a master module that is mounted in the CPU or local expansion rack.

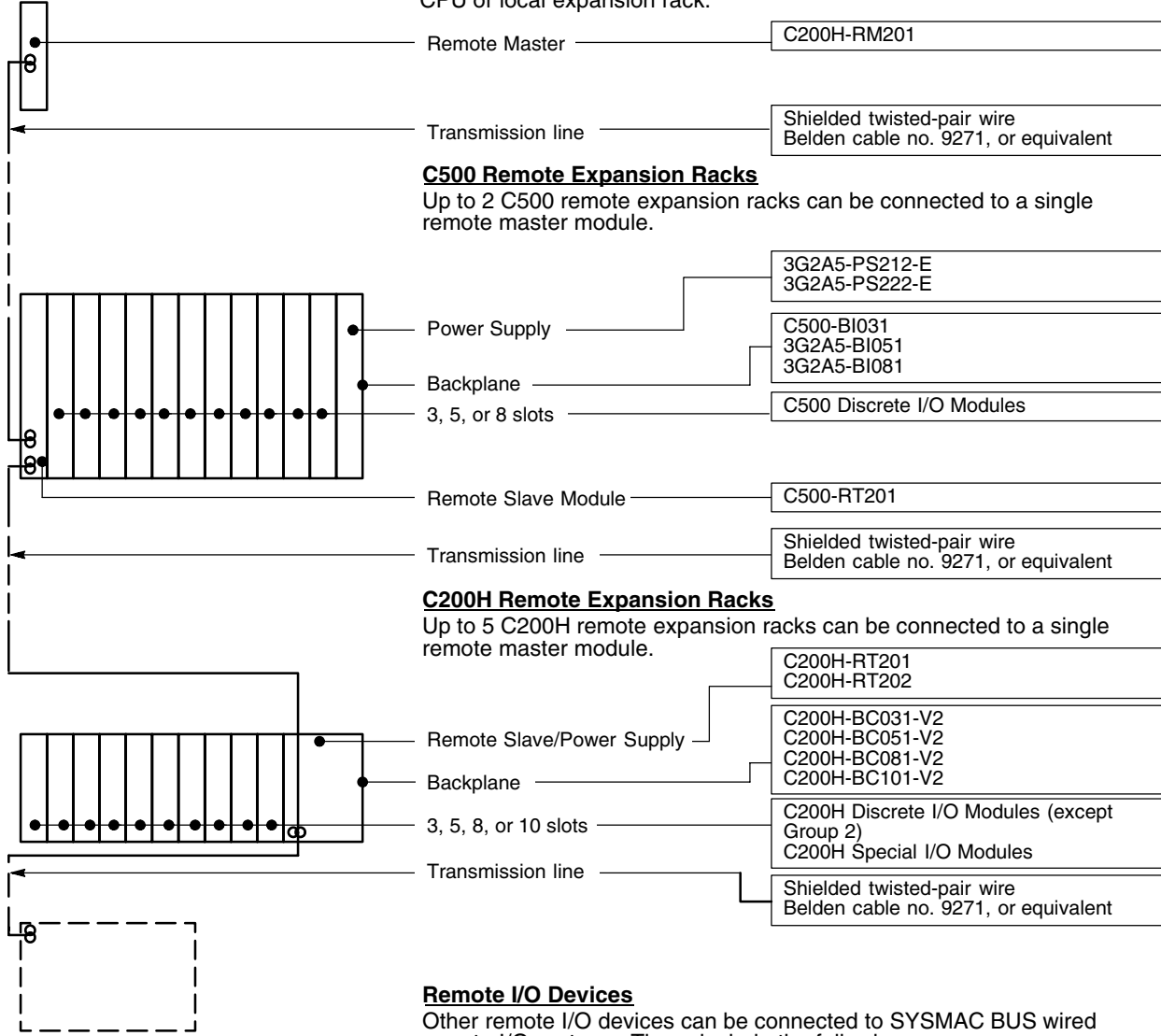

**C500 Remote Expansion Racks**

Up to 2 C500 remote expansion racks can be connected to a single remote master module.

**C200H Remote Expansion Racks**

Up to 5 C200H remote expansion racks can be connected to a single remote master module.

**Remote I/O Devices**

Other remote I/O devices can be connected to SYSMAC BUS wired remote I/O systems. These include the following:

- G7 Remote I/O Blocks and stand-alone slaves
- K3FS Remote Analog I/O Blocks
- NT20M, NT600M, NT2000M Programmable Terminals
- Third Party Devices: air valves, AC variable frequency drives, etc.

When configuring a SYSMAC BUS wired remote I/O network:

- ◆ A total of 32 words (512 bits) can be connected to a single Remote master.
- ◆ The following table indicates the number of I/O required for each remote rack and remote I/O device.

	No. of words	No. of I/O points
<b>C500H Remote Expansion Rack</b>	Depends on I/O Modules mounted*	
<b>C200H Remote Expansion Rack</b>	Depends on I/O Modules mounted*	
<b>G7 Remote I/O Block</b>	1	16
<b>NT20M Programmable Terminal</b>	4	64
<b>NT600M Programmable Terminal</b>	4	64
<b>K3FS Remote Analog I/O Block</b>	1	16
<b>Other devices</b>	Specific to the device	

\*Refer to the SYSMAC BUS Remote I/O System Manual (Cat. No. W120) for additional configuration information.

**Rack Configurations**

The following table summarizes the components required to form each type of rack in the different configurations. The number of each component required for the System is given in parentheses. The following combinations form the basic racks to which the other modules indicated in the first part of this section can be added.

Configuration	CPU Rack	Connecting cable	Local Expansion Rack
	CPU Backplane		Expansion Backplane
CPU Rack only	C200H-BC031-V2 C200H-BC051-V2 C200H-BC081-V2 C200H-BC101-V2 (one)	Not needed	Not needed
CPU Rack with Single Local Expansion Rack	C200H-BC031-V2 C200H-BC051-V2 C200H-BC081-V2 C200H-BC101-V2 (one)	C200H-CN___1	C200H-BC031-V2 C200H-BC051-V2 C200H-BC081-V2 C200H-BC101-V2 (one)
CPU Rack and Local Expansion Racks	C200H-BC031-V2 C200H-BC051-V2 C200H-BC081-V2 C200H-BC101-V2 (one)	C200H-CN___1 (one for each Local Expansion Rack)	C200H-BC031-V2 C200H-BC051-V2 C200H-BC081-V2 C200H-BC101-V2 (one for each Local Expansion Rack)

2

### Mounting Locations

The following table below summarizes the Modules that can be mounted to CPU, CPU Expansion, Local Expansion, and Remote Expansion Racks. For detailed information about the Modules listed below, refer to the manual for the individual Module.

Module	CPU Rack	Local Expansion Racks	SYSMAC BUS Remote Expansion Racks	Remarks
C200H-ASC02 ASCII/BASIC	Yes	Yes	Yes	Up to 10 Special I/O modules can be used with any C200H CPU. Refer to the following pages to determine rack current capacities.
C200H-AD001 C200H-AD002 C200H-DA001 Analog I/O Modules	Yes	Yes	Yes	
C200H-CT001 C200H-CT002 High-speed Counters	Yes	Yes	Yes	
C200H-NC112 C200H-NC211 Position Control Modules	Yes	Yes	Yes	
C200H-TS001 C200H-TS101 Temperature Sensor Module	Yes	Yes	Yes	
C200H-TC_ _ _ C200H-TV_ _ _ Temperature Controller Modules	Yes	Yes	Yes	
C200H-PID PID Module	Yes	Yes	Yes	
C200H-CP114 Cam Positioner	Yes	Yes	Yes	
C200H-ID501-V1 C200H-ID521 RFID Modules	Yes	Yes	Yes	
C200H-FZ001 Fuzzy Interference	Yes	Yes	No	
C200HS-INT01 (C200HS only)	Yes	No	No	Requires HS CPU and -V2 Backplane. 1 module max.
C200H-OV001 Voice output	Yes	Yes	Yes	Up to 10 Special I/O modules can be used with any C200H CPU. Refer to the following pages to determine rack current capacities.
C200H-TM001 Analog Timer Module	Yes	Yes	Yes	
Special High Density I/O Modules	Yes	Yes	Yes	
Group 2 High-Density I/O Modules	Yes	Yes	No	CPU 21/23/31/HS CPUs only up to five 64 pt. or ten 32 pt. modules.
C200H-B7A11 C200H-B7A01 B7A Interface	Yes	Yes	Yes	
Discrete I/O Modules	Yes	Yes	Yes	
SYSMAC NET Modules (CPU 31 only)	Yes	No	No	C200H-CPU31-E only (up to 2 modules total).
SYSMAC LINK Modules (CPU 31 only)	Yes	No	No	
SYSMAC BUS Remote Master Modules	Yes	Yes	No	
SYSMAC BUS I/O Link Modules	Yes	Yes	No	
C200H-LK201-V1 C200H-LK202-V1 Host Link Modules	Yes	Yes	No	

## Rack Current Capacity

The total current capacity for each rack is indicated in the following table, according to CPU, Power Supply, Remote Slave Module model. The internal circuitry of the built-in power supply is divided into three separate circuits. Each of these circuits must be calculated separately first, then collectively. Be sure each of the circuits is within the specification.

Rack		Current available			
		A (5 V)	B (26 V)	C (24 V)	D (total)
CPU Rack	C200H-CPU01-E	1.6 A	0.6 A	0.8 A	23 W
	C200H-CPU03-E	1.6 A	0.6 A	-	18 W
	C200H-CPU21-E	3.2 A	0.6 A	0.8 A	20-23 W*
	C200H-CPU23-E	1.6 A	0.6 A	-	18 W
	C200H-CPU31-E	3.0 A	0.6 A	0.8 A	19-22 W*
	C200HS-CPU01-E	3.9 A	0.6 A	0.8 A	23.5-26.5 W*
	C200HS-CPU03-E	2.3 A	0.6 A	-	21.5 W
	C200HS-CPU21-E	3.9 A	0.6 A	0.8 A	23.5-26.6 W*
	C200HS-CPU23-E	2.3 A	0.6 A	-	21.5 W
	C200HS-CPU31-E	3.9 A	0.6 A	0.8 A	23.5-26.6 W*
Local Expansion Rack	C200H-PS221	2.7 A	0.6 A	0.8 A	28 W
	C200H-PS211	2.7 A	0.6 A	-	23 W
Remote Expansion Rack	C200H-RT001-P	2.7 A	0.6 A	0.8 A	28 W
	C200H-RT002-P	2.7 A	0.6 A	-	23 W
	C200H-RT201	2.7 A	0.6 A	0.8 A	28 W
	C200H-RT202	2.7 A	0.6 A	-	23 W

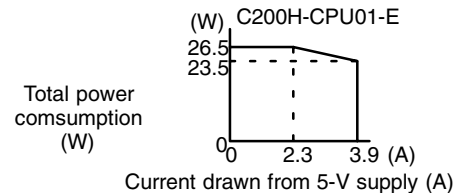
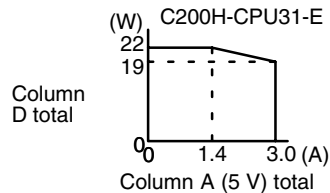
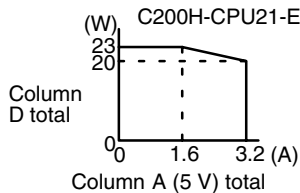

\*In the C200H-CPU21-E and C200H-CPU31-E, and C200HS-CPU01-E the available total (column D) depends upon the current of column A (5 V), as shown.

### Column A (5 V)

The maximum column A (5 V) current consumption of each module in the PLC system is shown in the tables that follow. Be sure the total column A current consumption of all the I/O modules planned for any one rack does not exceed the column A current capacity of that rack.

### Column B (26 V)

The maximum column B (26 V) current consumption of each module in the PLC system is shown in the tables that follow. Be sure the total column B current consumption of all the I/O modules planned for any one rack does not exceed the column B current capacity of that rack.

### Column C (24 V)

The maximum column C (24 V) current consumption of each Module in the PLC system is shown in the tables that follow. Be sure the total column C current consumption of all the I/O Modules planned for any one Rack does not exceed the column C current capacity of that Rack.

### Column D (Total Capacity)

Use the following formula to confirm that the total does not exceed column D (the total capacity for the power supply):

$$A \times 5 + B \times 26 + C \times 24 \leq D$$

Where,

A = the total current consumption from the column A tables above.

B = the total current consumption from the column B tables above.

C = the total current consumption from the column C tables above.

D = the column D data from the tables above.



### Modules

The maximum current consumption of each module is shown in the following tables.

#### Special I/O Modules

Description	Part number	Consumption
<b>ASCII/BASIC Coprocessor</b>		
PLC Module (Rack-mount); RAM, EEPROM	C200H-ASC02	0.20 A
<b>Analog Input Modules</b>		
4 pts.; 1 to 5 V, 0 to 10 V, 4 to 20 mA	C200H-AD001	0.55 A
8 pts.; 1 to 5 V, 0 to 10 V, ±10 V, 4 to 20 mA	C200H-AD002	0.45 A
<b>Analog Output Module</b>		
2 pts.; 1 to 5 V, 0 to 10 V, 4 to 20 mA	C200H-DA001	0.65 A
<b>High-speed Counters</b>		
	C200H-CT001-V1	0.30 A
	C200H-CT002	0.30 A
<b>1-axis Position Control</b>		
	C200H-NC112	0.15 A
<b>2-axis Position Control</b>		
	C200H-NC211	0.50A
<b>Temperature Sensor Modules</b>		
	C200H-TS001	0.45 A
	C200H-TS101	0.45 A
<b>Temperature Controller Modules</b>		
Thermocouple Input	C200H-TC00_	0.33 A
RTD Input	C200H-TC10_	0.33 A
<b>Heat/Cool Temperature Controller Modules</b>		
Thermocouple Input	C200H-TV00_	0.33 A
RTD Input	C200H-TV10_	0.33 A
<b>PID Modules</b>		
	C200H-PID0_	0.33 A
<b>Cam Positioner</b>		
	C200H-CP114	0.30 A
<b>Radio Frequency Identification Systems (V600 Short-range RF ID Systems)</b>		
PLC Module (Rack-mount)	C200H-IDS01-V1	0.25A
<b>Radio Frequency Identification Systems (V620 Long-range RF ID Systems)</b>		
PLC Module (Rack-mount)	C200H-IDS21	0.25A
<b>Fuzzy Coprocessor</b>		
	C200H-FZ001	0.30 A
<b>Interrupt Input Module (C200HS only)</b>		
	C200HS-INT01	0.20 A
<b>Voice Output Module</b>		
	C200H-OV001	0.30 A
<b>Analog Timer Input Module</b>		
	C200H-TM001	0.60 A
<b>High-density Input</b>		
	C200H-ID215	0.13 A
	C200H-ID501	0.13 A
<b>High-density Mixed</b>		
	C200H-MD115	0.18 A
	C200H-MD215	0.18 A
	C200H-MD501	0.18 A
<b>High-density Output</b>		
	C200H-OD215	0.22 A

**2**

Description	Part number	Consumption
<b>High-density Output</b>		
	C200H-OD501	0.22 A
<b>B7A Interface Modules</b>		
	C200H-B7A11	0.10 A
	C200H-B7AO1	0.10 A

**Discrete Input Modules**

Voltage	Points (/common)	Part number	Consumption
<b>No Voltage Contact Input</b>			
No voltage contact/NPN output type	8 (8/common)	C200H-ID001	0.01 A
No voltage contact/PNP output type	8 (8/common)	C200H-ID002	0.01 A
<b>DC Inputs</b>			
12 to 24 VDC	8 (8/common)	C200H-ID211	0.01 A
24 VDC	16 (16/common)	C200H-ID212	0.01 A
24 VDC	32 (32/common)	C200H-ID216*	0.1 A
24 VDC	64 (32/common)	C200H-ID217*	0.12 A
<b>AC Inputs</b>			
100 to 120 VAC	8 (8/common)	C200H-IA121	0.01 A
100 to 120 VAC	16 (16/common)	C200H-IA122	0.01 A
200 to 240 VAC	8 (8/common)	C200H-IA221	0.01 A
200 to 240 VAC	16 (16/common)	C200H-IA222	0.01 A
<b>AC/DC Inputs</b>			
12 to 24 VAC/VDC	8 (8/common)	C200H-IM211	0.01 A
24 VAC/VDC	16 (16/common)	C200H-IM212	0.01 A

\*CPU21, CPU23, CPU31 and HS only (Group 2)

**Discrete Output Modules**

Current/voltage	Points (/common)	Part number	Consumption
<b>Transistor Outputs</b>			
0.3 A, 24 VDC	12 (12/common)	C200H-OD211	0.16 A
0.3 A, 24 VDC	16 (16/common)	C200H-OD212	0.18 A
2.1 A, 24 VDC	8 (8/common)	C200H-OD213	0.14 A
0.8 A, 24 VDC	8 (8/common)	C200H-OD214	0.14 A
0.3 A, 5 to 24 VDC	8 (8/common)	C200H-OD216	0.01 A
0.3 A, 12 to 24 VDC	12 (12/common)	C200H-OD217	0.01 A
4.5 to 26.4 VDC	32 (32/common)	C200H-OD218*	0.18 A
4.5 to 26.4 VDC	64 (32/common)	C200H-OD219*	0.27 A
1 A, 12 to 24 VDC	8 (8/common)	C200H-OD411	0.14 A
*CPU21, CPU23, CPU31 and HS only (Group 2)			
<b>Triac Outputs</b>			
120 VAC	–	C200H-OA121-E	0.14 A
250 VAC	–	C200H-OA221	0.2A
250 VAC	–	C200H-OA222	0.14A
<b>Relay Outputs</b>			
24 VDC/250 VAC	5 (independant commons)	C200H-OC221	0.01 A
24 VDC/250 VAC	8 (independant commons)	C200H-OC222	0.01 A
24 VDC/250 VAC	8 (8/common)	C200H-OC223	0.01 A
24 VDC/250 VAC	12 (12/common)	C200H-OC224	0.01 A
24 VDC/250 VAC	16 (16/common)	C200H-OC225	0.05 A

### Communication Modules

Module	Part number	Consumption
SYSMAC NET	C200HS-SNT32	1 A
SYSMAC LINK	C200HS-SLK12, C200HS-SLK22	0.8 A each
SYSMAC WAY Host Link Module	C200H-LK101-P, C200H-LK201, C200H-LK202	0.25 A each
SYSMAC BUS Fiber-optic Master	C200H-RM001-PV1	0.2 A
SYSMAC BUS Wired Master	C200H-RM201	0.25 A
SYSMAC BUS Fiber-optic Slave	C200H-RT002-P	02.7 A
SYSMAC BUS Wired Slave	C200H-RT201	0.1 A
SYSMAC BUS Wired Slave	C200H-RT202	0.08 A
PC Link	C200H-LK401	0.35 A

### Column B (26 V)

The maximum column B (26 V) current consumption of each module in the PLC system is shown in the table that follows. Be sure the total column B current consumption of all the I/O modules planned for any one rack does not exceed the column B current capacity of the rack.

Module	Part number	Consumption
<b>Discrete Output Modules</b>		
Relay Output (Current draw with eight bits on simultaneously)	C200H-OC221	0.075 A
	C200H-OC222	0.075 A
	C200H-OC223	0.075 A
	C200H-OC224	0.075 A
	C200H-OC225	0.075 A
	C200H-OC216	0.075 A
	C200H-OC217	0.075 A
<b>Special I/O Modules</b>		
RF ID	C200H-IDS01-V1	0.12 A
	C200H-IDS21	0.12 A

**Column C (24 V)**

The maximum column C (24 V) current consumption of each module in the PLC system is shown in the table that follows. Be sure the total column C current consumption of all the I/O Modules planned for any one Rack does not exceed the column C current capacity of the Rack.

Module	Part number	Consumption
<b>Discrete Input Modules</b>		
No Voltage Contact Input	C200H-ID001	0.06 A
	C200H-ID002	0.06 A
Other devices connected to the external 24 VDC power supply		Total of devices

**Column D (Total Capacity)**

Use the following formula to confirm that the total does not exceed column D (the total capacity for the power supply):

$$A \times 5 + B \times 26 + C \times 24 \leq D$$

Where,

A = the total current consumption from the column A tables above.

B = the total current consumption from the column B tables above.

C = the total current consumption from the column C tables above.

D = the column D data from the tables above.

2

### Input Wiring Accessories

#### B7A Output Connectors/B7A Input Blocks

Module part number	Consumption
B7A-R6A13	0.04 A max.
B7A-R6A33	0.04 A max.
B7A-R6A18	0.04 A max.
B7A-R6A38	0.04 A max.
B7A-R3A13	0.06 A max.
B7A-R3A33	0.06 A max.
B7A-R3A18	0.06 A max.
B7A-R3A38	0.06 A max.
B7A-T6A1	0.12 A max. when all Input points are turned on. Excludes exterior sensor unit.
B7A-T6B1	0.12 A max. when all Input points are turned on. Excludes exterior sensor unit.
B7A-T6C1	0.12 A max. when all Input points are turned on. Excludes exterior sensor unit.
B7A-T6A6	0.12 A max. when all Input points are turned on. Excludes exterior sensor unit.
B7A-T6B6	0.12 A max. when all Input points are turned on. Excludes exterior sensor unit.
B7A-T6C6	0.12 A max. when all Input points are turned on. Excludes exterior sensor unit.

#### P7TF, G7TC Input Blocks

Module part number	Consumption
G7T-1122S-DC12V	0.042 A
G7T-1122S-DC24V	0.021 A
G7T-1122S-AC110/120V	0.0064-0.007 A
G7T-1122S-AC220/240V	0.0032-0.0035 A
G3TA-IAZR02S-AC100-240V	0.005 A
G3TA-IDZR02S-DC5-24V	0.005 A

The power supply requirements are calculated as follows:

$$80 \text{ mA} + M + D + I = C$$

80 mA: current required by Input Block

M: Total current of Input Modules

D: input device current (sensor, etc.)

I: interface device (G71, PLC Input Module, etc.) current

C: required current capacity of power supply

*Output Wiring Accessories*

**B7A Input Connectors/B7A Output Blocks**

Module part number	Consumption
B7A-T6E3	0.06 A max.
B7A-T6E8	0.06 A max.
B7A-T3E3	0.1 A max.
B7A-T3E8	0.1 A max.
B7A-R6B11	0.08 A max.
B7A-R6B31	0.08 A max.
B7A-R6B16	0.08 A max.
B7A-R6B36	0.08 A max.
B7A-R6F11	0.08 A max.
B7A-R6F31	0.08 A max.
B7A-R6F16	0.08 A max.
B7A-R6F36	0.08 A max.
B7A-R6C11	0.1 A max.
B7A-R6C31	0.1 A max.
B7A-R6C16	0.1 A max.
B7A-R6C36	0.1 A max.
B7A-R6G11	0.1 A max.
B7A-R6G31	0.1 A max.
B7A-R6G16	0.1 A max.
B7A-R6G36	0.1 A max.

### P7TF, G7TC Output Blocks

Module part number	Consumption
G7T-1112S-DC12V	0.042A
G7T-1112S-DC24V	0.021 A
G7T-1012S-DC12V	0.042 A
G7T-1012S-DC24V	0.021 A
G3TA-OA202SZ-DC24V	0.016 A
G3TA-ODX02S-DC24V	0.005 A
G3TA-OD201S-DC24V	0.005 A

The power supply requirements are calculated as follows:

$$40/80 \text{ mA} + M + I = C$$

40/80 mA: current required by 8/16-point Output Block

M: Total current of Output Modules

I: interface device (G71, PLC Output Module, etc.) current

C: required current capacity of the Power Supply

### Remote I/O Stand-alone Slaves

#### G71 SYSMAC BUS Wired Remote I/O Stand-alone Slave

Slave	Consumption
Input G71-IC16-DC24V	40 mA + (6.7 mA x no. of inputs)
Output G71-OD-DC24V	40 mA

**General Information**

To assist in selection of system components, a series of system configuration worksheets have been provided. These worksheets are intended to assist the system designer in determining:

- ◆ Required system components and part numbers
- ◆ Total I/O requirements
- ◆ Power consumption of modules

The worksheets are used in conjunction with the Standard Parts section and the Configuration section of this catalog. The worksheets provided can be duplicated as needed for full system configuration. Separate worksheets are provided for:

- ◆ CPU Rack
- ◆ Local Expansion Rack
- ◆ SYSMAC BUS Remote I/O System

CPU Rack										
Required Parts							Qty.	Part number(s) selected		
	CPU						1			
	CPU Backplane						1			
	Slots	Current consumption				Pts.				
		A	B	C	D					
	1						1			
	2						1			
	3						1			
	4						1			
	5						1			
	6						1			
	7						1			
	8						1			
	9						1			
	10						1			
Optional Parts										



Local Expansion Rack								
Required Parts						Qty.	Part number(s) selected	
	Power Supply					1		
	Expansion Backplane (3, 5, 8, or 10 slots)					1		
	Slots	Current consumption				Pts.		
		A	B	C	D			
	1					1		
	2					1		
	3					1		
	4					1		
	5					1		
	6					1		
	7					1		
	8					1		
	9					1		
	10					1		
Required for single Local Expansion Rack								
	I/O Cable for single Local Expansion Rack (1 for each Rack)					1		

2

**2**

SYSMAC BUS C500 Remote Expansion Rack						Fiber-optic	Wired
Required Parts						Qty.	Part number(s) selected
Remote Master Module must be mounted in CPU, or Local Expansion Rack							
Power Supply						1	
Expansion Backplane (3, 5, or 8 slots)						1	
Slots	Current consumption				Pts.		
	A	B	C	D			
1						1	
2						1	
3						1	
4						1	
5						1	
6						1	
7						1	
8						1	
9	Remote Slave Module				—	1	
Required for Fiber-optic System							
Fiber-optic Cable						1	
Fiber-optic Connector						2	
Required for Wired System							
Twisted-pair wire						1	Commercially available

SYSMAC BUS C200H Remote Expansion Rack							Fiber-optic	Wired
Required Parts						Qty.	Part number(s) selected	
Remote Master Module must be mounted in CPU, or Local Expansion Rack								
Power Supply/Remote Slave Module						1		
Expansion Backplane (3, 5, 8, or 10 slots)						1		
Slots	Current consumption				Pts.			
	A	B	C	D				
1						1		
2						1		
3						1		
4						1		
5						1		
6						1		
7						1		
8						1		
9						1		
10						1		
Required for Fiber-optic System								
Fiber-optic Cable						1		
Fiber-optic Connector						2		
Required for Wired System								
Twisted-pair wire						1	Commercially available	
SYSMAC BUS Remote I/O Devices								
Device						I/O words		

**2**

<b>Peripheral Devices</b>			
	<b>Software or Device</b>	<b>Part number(s) selected</b>	
	Ladder Support Software	1	
	Peripheral Port Cable	1	
	Programming Console	1	
	Programming Console Cable	1	
	Graphic Programming Console	1	
	Memory Pack	1	
	NT Programmable Terminals	1	
	Software	1	
	Data Access Console	1	

Unit: mm (inches)

## CPU Backplanes

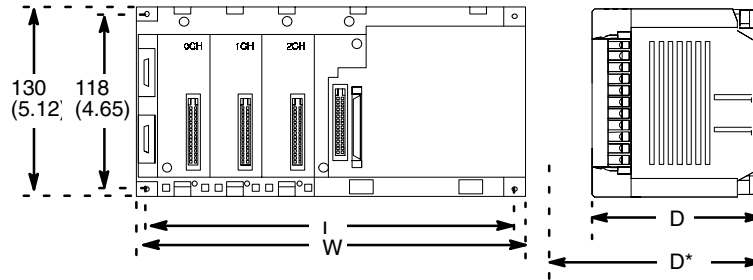

Part number	Slots	L	W	D (CPU alone) and D* (CPU with programming console mounted)
C200H-BC031-V2	3	246 (9.7)	260 (10.2)	D: C200H-CPU01-E/CPU03-E/CPU21-E/CPU23-E: 118 (4.65) C200H-H-CPU031-E: 143 (5.63)
C200H-BC051-V2	5	316 (12.4)	330 (13)	C200H-HS-CPU01-E/CPU03-E: 113 (4.45) C200H-HS-CPU21-E/CPU23-E/CPU31-E/CPU33-E: 138 (5.43)
C200H-BC081-V2	8	421 (16.6)	435 (17.1)	
C200H-BC101-V2	10	491 (19.3)	505 (19.9)	D*: C200H-CPU01/CPU03/CPU21/CPU23: 148 (5.83)



# 10 Operator Interfaces

Programmable Terminals .....	132
Data Access Console .....	136

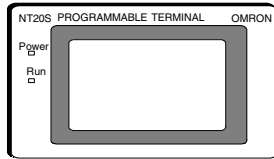

NT20S

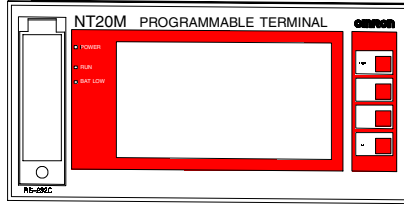

NT20M-DT

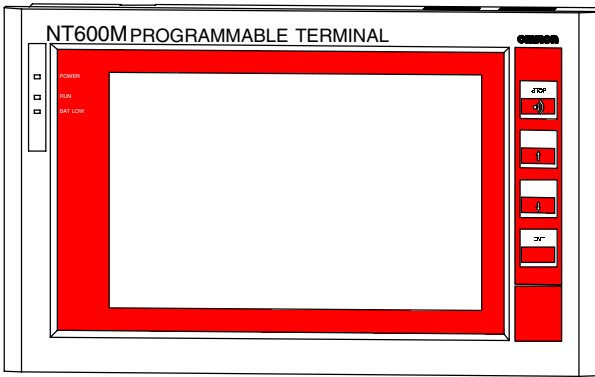

NT600M-DT

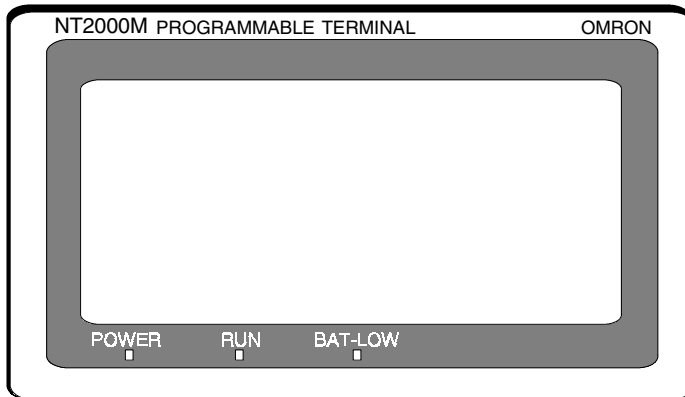

NT2000M

## General Information

Omron's NT-series Programmable Terminals combine the latest in flat panel technology and software innovation to meet the most demanding man-machine interface requirements. Flexible configuration, multi-function software capability, and advanced hardware design make the NT-series the best choice for the widest variety of industrial applications. The NT-series Programmable Terminals provide the combined functionality of several devices, including programmable message display, alarm annunciator, operator control station, and graphics display station. These functions are all centralized in a single flexible device that offers immediate access to machinery status or production line information. The NT-series can also eliminate the need for hundreds of pushbuttons, warning lights, thumbwheel switches, message displays and digital readouts and save the cost of installing, maintaining and replacing those devices. The simplicity and accessibility of our NT-series allows you to perform data collection, process monitoring, operator control and alarm verification with certainty.

## Features

- ◆ Programming software required to configure, edit, upload, and download screens
- ◆ Plug-in communications modules allow several interface options
- ◆ Installed and wired, requires only 3.5 inches of depth to help reduce panel size
- ◆ Touch screen or function key types allow for the best application fit



### Specifications: NT20M and NT20S

<b>Display Screen</b>	Dot matrix STN LCD panel with 4.4 x 2.2 inches display area
<b>Resolution</b>	256 x 128 resolution
<b>Backlight</b>	Cold cathode tube
<b>Dimensions</b>	
NT20M-DT	164H x 220W x 82D mm (6.5 x 8.7 x 3.3 in.)
NT20M-DN NT20-FK201	110H x 220W x 82D mm (4.33 x 8.7 x 3.3 in.)
NT20S	110H x 190W x 53.3D mm (4.33 x 7.48 x 2.11 in.)
<b>Display capabilities</b>	250 screens maximum, overlapping and continuous functions (chain)

### Specifications: NT600M

<b>Display Screen</b>	Dot matrix STN LCD Panel with 8.1 x 5.1 inches display area
<b>Resolution</b>	640 x 400 resolution
<b>Backlight</b>	Cold cathode tube
<b>Dimensions</b>	
NT600M-DT	198H x 325W x 105D mm (7.8 x 12.8 x 4.1 in.)
NT600M-DF	238H x 325W x 105D mm (7.8 x 12.8 x 4.1 in.)
<b>Display capabilities</b>	1000 screens maximum, overlapping and continuous functions (chain)

### Specifications: NT2000M

<b>Display Screen</b>	Dot matrix STN LCD Panel with bi-color red or white display, 275 x 138 mm (10.83 x 5.43 in.)
<b>Resolution</b>	256 x 128 resolution
<b>Backlight</b>	Cold cathode tube
<b>Dimensions</b>	
NT2000MT-DT131	232.5H x 365W x 77D mm (9.15 x 14.37 x 3.03 in.)
NT2000M-DN131	232.5H x 365W x 77D mm (9.15 x 14.37 x 3.03 in.)
<b>Display capabilities</b>	250 screens maximum, overlapping and continuous functions (chain)

## Communications

### Connecting to SYSMAC WAY Host Link (NT20S)



### Connecting to SYSMAC BUS Wired Remote I/O (NT20M, NT600M, and NT2000M)

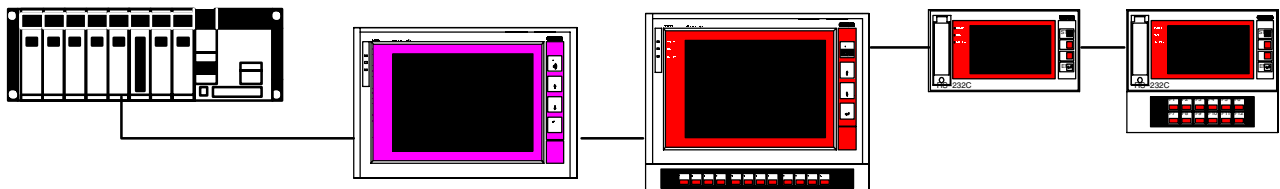

### Connecting to C200H Backplane (NT20M, NT600M, and NT2000M)

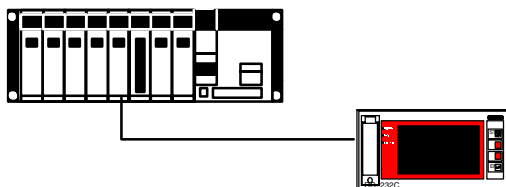

**Programmable Terminals**

Description	Part number
<b>NT20S</b>	
Touch panel LCD – color beige	NT20S-ST121
Touch panel LCD – color black	NT20S-ST121B
<b>NT20M</b>	
Touch screen terminal, no memory	NT20M-DT121-V2
Touch screen terminal, no memory, bi-color backlight	NT20M-DT131
Non-touch screen, no memory, bi-color backlight	NT20M-DN131
Non-touch screen, no memory	NT20M-DN121-V2
12 Function key unit	NT20M-FK210
<b>NT600M</b>	
Touch screen terminal, no memory, LCD display	NT600M-DT122
Touch screen terminal, no memory, Electroluminescent display	NT600M-DT211
Function key terminal, no memory, LCD display	NT600M-DF122
Non-touch screen terminal, no memory, Electroluminescent display	NT600M-DN211
12 Function key unit for NT600M-DN211	NT600M-FK210
Card with empty socket	NT600M-MP251
Card with 64K RAM	NT600M-MR641
Card with 128K RAM	NT600M-MR151
Card with 128K RAM	NT600M-MR151
Card with 256K RAM	NT600M-MR251
System ROM for NT600M	NT600M-SMR01-E
System ROM for NT600M	NT600M-SMR02-E
<b>NT2000M</b>	
Touch screen terminal, no memory, bi-color backlight	NT2000M-DT131
Non-touch screen, no memory, bi-color backlight	NT2000M-DN131
System key unit for remote operation	NT-FK200

**Interface Modules and Accessories**

Description	Part number	Required System ROM
<b>NT20M and NT2000M</b>		
RS-232C interface module	NT600M-LK201	NT20M-SMR01-E
RS-422 interface module	NT600M-LK202	NT20M-SMR01-E
Host Link interface module	NT600M-LK201	NT20M-SMR01-E
SYSMAC BUS interface (wired)	NT600M-RT121	NT20M-SMR01-E
C200H Expansion I/O Interface	NT600M-LB121	NT20M-SMR02-E
Host Link Interface Definable Addressing	NT600M-LK201	NT20M-SMR31-E
C200H Expansion I/O Interface Definable Addressing	NT600M-LB122	NT20M-SMR32-E
Backlight unit for NT20M-DT131 and NT20M-DN131	NT20M-CFL01	
Backlight unit for NT2000M-DT131 and NT2000M-DN131	NT2000M-CFL01	
Cable for programming the terminal	CV500-CN228	
Cover for NT20M-DT	NT20M-KBA01	
Cover for NT20M-DN	NT20M-KBA02	
Non-glare sheets	NT20M-KBA03	
Oil and waterproof covers	NT20M-KBA04	
Key Sheet replacement for NT20M-DN	NT20M-CKF01	

## Interface Modules and Accessories continued

Description	Part number	Required System ROM
<b>NT600M</b>		
RS-232C/Host Link interface module	NT600M-LK201	NT-600M-SMR01-EV1
RS-422 interface module	NT600M-LK202	NT-600M-SMR01-EV1
SYSMAC BUS interface (wired)	NT600M-RT121	NT-600M-SMR01-EV1
C200H BUS interface	NT600M-LB121	NT-600M-SMR02-EV1
Host Link direct addressing	NT600M-LK201	NT-600M-SMR31-E
C200H BUS direct addressing	NT600M-LB122	NT-600M-SMR32-E
Cover for NT600M-DT	NT600M-KBA01	
Cover for NT600M-DF	NT600M-KBA02	
Non-glare sheet	NT600M-KNA03	
Oil and water proof cover	NT600M-KBA04	
Key Sheet replacement for NT600M-DF	NT600M-CKF01	
<b>Common Accessories</b>		
Expansion I/O Connecting Cable; 30 cm	C200H-CN311	
Expansion I/O Connecting Cable; 70 cm	C200H-CN711	
Expansion I/O Connecting Cable; 2 m	C200H-CN221	
Expansion I/O Connecting Cable; 5 m	C200H-CN521	
Expansion I/O Connecting Cable; 10 m	C200H-CN131	
NT Series Host Interface Unit Direct Connection Manual	V015-E1-1	
NT Series RS-232C/RS-422 Interface Unit Operation Manual	V016-E1-1	
NT20M and NT2000M Operation Manual	V001-E1-2	
NT600M Operation Manual	V002-E1-2	
Host Interface Units Operation Manual	V003-E1-3	
Support Software, 3.5 and 5.25 inch disks	NT20M-ZASAT-EV4	
Programming Cable, PT to computer (9-pin RS-232)	C200H-CN229-EU	
Programming Cable, PT to computer (25-pin RS-232)	C200H-CN220-EU	

## Memory Chips for NT20M and NT200M

Type	Memory chips	Part number
SRAM	32K 128K	RAM-22-15 RAM-13-10
EPROM	64K 128K	ROM-KD-B ROM-13-12B
EEPROM	32K	EE22-20

## Screen Data Memory Boards (required for NT600M)

Memory capacity	Type	Part number
Depends on memory chip	IC socket type	NT600M-MP251
64K	SRAM	NT600M-MR641
128K	SRAM	NT600M-MR151
256K	SRAM	NT600M-MR251

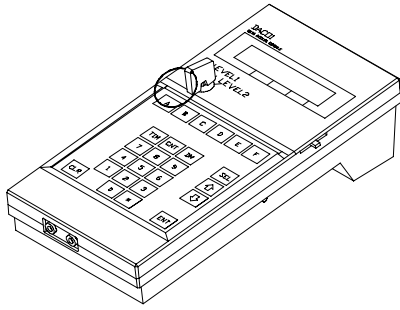

### General Information

Omron's Data Access Console provides on-line monitoring and alteration of data in the PLC's data memory, I/O and internal relay and special relay areas. Two levels of accessibility allow secure areas of data as well as password protection. The DAC displays messages when alarm or message instructions are used in programming. The Data Access Console can be used with the C20, K-type, block-style H-type, C200H, C1000H, and C2000H PLCs.

# 11 Peripheral Devices

Ladder Support Software .....	138
GPC, Programming Consoles .....	140
Factory Intelligent Terminal, PROM Writer, Printer Interface ...	141
Programmable Terminal Support Software .....	142

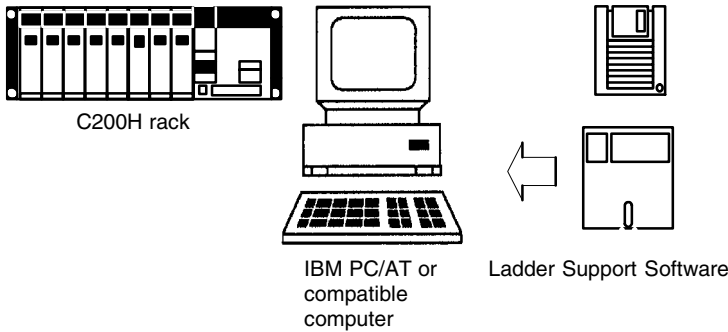

**PLC Setup**

The LSS provides two different means to set the operating parameters in the PLC Setup, which determine the basic operating environment for the C200H. For standard settings you can take advantage of the speed and ease of menu settings, or you can use direct bit settings in the DM PLC Setup Area to make for detailed settings for sophisticated applications.

**Ladder Support Software (LSS)**

C200H programming and monitoring can be handled easily using an IBM PC/AT or compatible computer running OMRON's LSS. The LSS is the most powerful programming device for C200H. Besides creating programs, the LSS can be used to generate all kinds of lists, create I/O, line, and block comments, print out ladder programs in mnemonic form or as ladder diagrams, store programs on disk, etc.

**Programming**

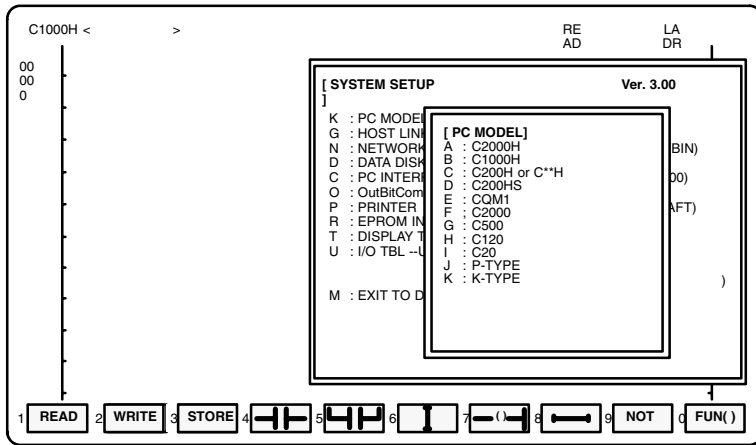

**Programming**

The LSS provides fast and easy programming operations based on function keys and instruction function codes that make it easy to input, search through, and edit ladder diagrams. You can also use the LSS to edit the program in the PLC online in MONITOR or PROGRAM mode to make file program adjustments during actual test runs.

**Monitoring and Operation Control**

You can not only monitor bit status in the ladder diagram, specified I/O status, word content, or DM content, but you can also control status or memory contents during monitoring operations to control the CQM1 or to aid in debugging the program.

**Monitoring**

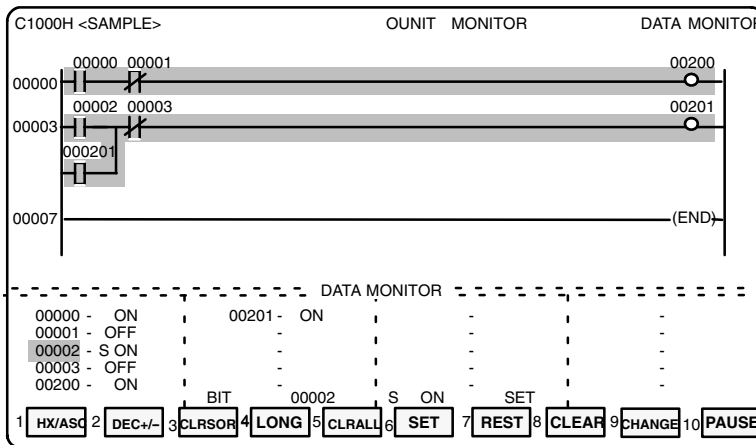

**Comments**

Three forms of comments are available to aid in programming, debugging, troubleshooting, and program management. I/O comments let you keep track of I/O applications; block comments can be used to tell what instruction blocks (e.g., output instructions) are being used for; and line comments can be used to provide more detailed information on sections of the program.

**New Differential Monitor**

Ensure accurate detection of ON-to-OFF or OFF-to-ON transition bits in the C200HS memory.

## Reporting

[ UTILITY ]

[ PRINTER ]

[ LADDER DIAGRAM PRINT ]

ENTER LINES PER PAGE [66 TO 132] 066

ENTER BEGIN ADDRESS 00000

ENTER END ADDRESS END

[ TO END: E ALL: A ]

ENTER TITLE ( UP TO 70 CHARACTERS )

PRINT I/O COMMENTS ( Y/N )? N

PRINT INSTRUCTION COMMENTS ( Y/N )? N

PRINT BLOCK COMMENTS ( Y/N )? ( Y/N )? N

CHANGE PAGES [ Y/N ] Y

ENTER CROSS-REFERENCE LEVEL [ 0-2 ] 0

0 : NONE

1 : BASIC INSTRUCTIONS

2 : ALL INSTRUCTIONS

ENTER BEGIN PAGE [ 1 TO 999 ] 001

CONFIRM ( Y/N )?  Y

## Reporting

User configurable for custom printouts. Print out complete or partial programs in ladder or mnemonics. Selectively choose which tables and cross references are to be included and documentation.

## Debugging

In addition to syntactical program checks, you can use any of a number of LSS to debug your ladder-diagram programs before and during trial operation, including step-by-step execution or block execution, as well as any of the monitoring or tracing operations.

## Data Management

Programs, DM data, trace results, PLC Setups, I/O tables, and other forms of data can be easily transferred around the system or to and from data disks to achieve a complete data management system.

In addition, LSS3 easily saves and retrieves partial programs for simple creation of a library of commonly used sections of code.

## Tracing

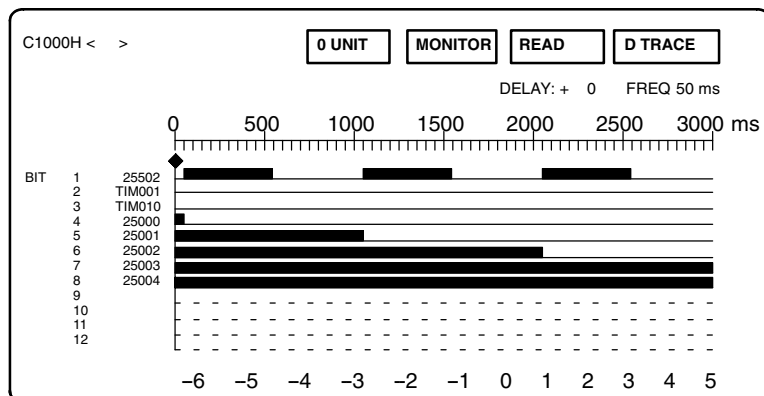

## Tracing

Debugging, monitoring, and system management are greatly aided by tracing operations that record the status of executed instructions or the contents of specified memory bits/words. Trace result can be stored for later analysis or archiving.

## LSS Ordering Information

Description	Part number	
Single-user license	C500-Y9LS11-EV3	
5-user license	C500-Y9LS15-EV3	
10-user license	C500-Y9LS10-EV3	
Programming Cable	Built-In Host Link Port to computer (9-pin RS-232)	C200HS-CN220-EU
	Built-In Host Link Port to computer (25-pin RS-232)	C200HS-CN229-EU
	C200H-LK201 to computer (9-pin RS-232)	C500-CN221-EU
	C200H-LK201 to computer (25-pin RS-232)	C500-CN222-EU

## System Information

PLCs supported	C**K, C**H, CQM1, C200H, C200HS, C500, C1000H, C2000H
Communications supported	SYSMAC NET, SYSMAC LINK, HOST LINK
Computer requirements	IBM-PC XT/AT or fully compatible computer
<b>Specifications</b>	
RAM capacity	At least 640 KB RAM
Free work disk capacity	At least 3MD of free disk space
Floppy disk drive	Either a 5.25 or 3.5 double density drive, Communication port 1 or 2, with RS-232C or RS-422
Video	Color/monochrome monitor (CGA, EGA, VGA, MDA)

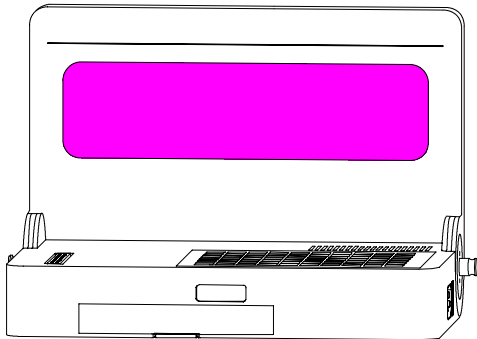

**Graphic Programming Console: 3G2C5-GPC03-E/GPC04-E**

The Graphic Programming Console has a 32K-word memory and is a complete programming, monitoring and debugging tool. The GPC has a backlit LCD display and function key panel for programming and monitoring mnemonics or ladder logic. The GPC can also communicate over SYSMAC NET or SYSMAC LINK Networks by being connected to any PLC running on either Network. The GPC is available in 110-VAC and 220-VAC versions.

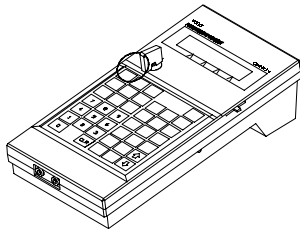

**Programming Console: C200H-PRO27-E**

The C200H-PRO27-E is a complete on-line and off-line programming and monitoring hand-held console. The C200H-PRO27-E comes with an LCD display with LED illumination, 16 characters x 2 lines, adjustable sound and contrast.

In addition to programming and monitoring with the Programming Console, users can verify programs, compare and create I/O tables, monitor multiple I/O, force set/reset bits, and choose from Run, Monitor, Debug, or Program modes.

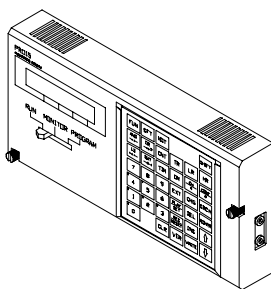

**Programming Console: 3G2A6-PRO15-E**

All of the functions are identical to C200H-PRO27-E. The 3G2A6-PRO15-E mounts directly to the CPU.



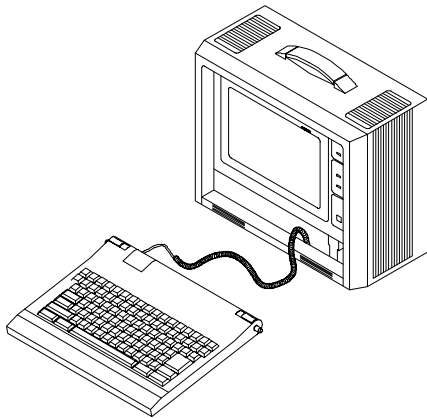

### Factory Intelligent Terminal (FIT10-SET11E)

Compatible with all C-Series PLCs, the FIT combines the functions of several peripherals into one. In addition to programming functions, the FIT incorporates a PROM writer and two 3.5-inch floppy disk drives, plus interfaces for printers and other devices. The FIT allows program loading, editing, and monitoring of any C-series PLC. Easy-to-use editing functions include cut/paste/move, and pull-down window menus. The FIT lets you transfer programs, data memory contents and ladder diagram comments quickly. Powerful diagnostic and debugging capabilities include data trace, timing charts, and I/O monitoring. Even with all its capabilities the FIT is small enough and light enough to take on-site for trial operation and system debugging.

The large plasma screen shows 9 inputs and one output across and 11 ladder rungs and 1 message line or 30 mnemonic programming lines or 120 line comments, as well as a function key template for easy use. The FIT has one each of RS-232C and RS-422 ports.

FIT can be used with the C20, K-type, block-style H-type, C200H, C1000H, and C2000H PLCs.

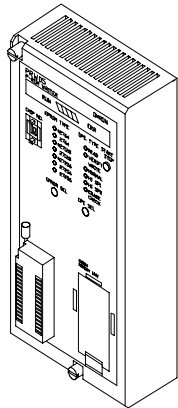

### PROM Writer: C500-PRW06

Compatible with all C-series PLCs, Omron's PROM writer is used to write data from the program memory (UM), holding relay (HR), timer/counter (TC), data memory (DM) and auxiliary relay (AR) areas to an EPROM chip or C200H Memory Pack. You then have a permanent copy of the program or data and can make further copies of the same data if it is required by another PLC of the same model. The PROM writer can be attached either directly to the PLC or through the GPC.

The PROM Writer can be used with the C20, K-type, Block-style H-type, C200H, C1000H, and C2000H PLCs.

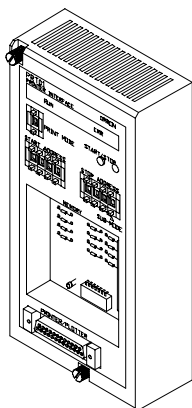

### Printer Interface: 3G2A5-PRT01-E

With the Printer Interface, you can easily print various lists, such as program lists, cross-reference lists, and error lists. Desktop program debugging is easier because the program and error lists can be printed out in both mnemonics format and ladder diagram format. You can see at a glance the I/Os, TIM/CNTs, etc. that are used by printing out the cross-reference list for the program. In addition, you can print the contents of the data memory (DM) area, which will greatly help you manage and check the process the PLC performs.

The Printer Interface can be used with the C20, K-type, block-style H-type, C200H, C1000H, and C2000H PLCs. Refer to Standard Parts for the proper memory pack.

**General Information**

Programmable Terminal Support Software allows the user to configure messages, operator prompts, alarms, touch switches, indicators, simple graphics, or any combination of these to provide the best overview of the machine or process to the operator. Control programming is accomplished using relay ladder logic (RLL) for SYSMAC BUS and Host Link interfaces, or ASCII characters for RS-232C and RS-422 configurations.

**Features**

- ◆ Design, upload, and download Programmable Terminal screens
- ◆ IBM-PC XT/AT, or fully compatible computer
- ◆ Either a 5.25" or 3.5" double density disk drive
- ◆ A hard disk with at least 3 MB of free disk space
- ◆ At least 640 Kb RAM
- ◆ PC-DOS, MS-DOS, or equivalent (version 3.2 or higher)
- ◆ Communication port 1 or 2, with RS-232C or RS-422
- ◆ Color/monochrome monitor (CGA, EGA, VGA, MDA)
- ◆ Edit and copy screen layouts
- ◆ Save screen files to disk
- ◆ Configure screen messages, graphics, data display, touch switches (touch-type only), and indicator lamps

**System Requirements**

<b>Part number</b>	<b>NT20M-ZASAT-EV4</b>
System disk	3.5 inch, 2DD and 5 inch, 2HD
Applicable computers	IBM PC/AT or IBM PC/AT compatible
DOS version	MS-DOS Version 3.2 or later
Floppy disk drives necessary	1 minimum
RAM	640 Kbytes minmum
Graphic monitor	VGA
Communication settings	Baud rate: 9,600 bps Stop bits: 1 bit Data length: 8 bits Parity: None The Intel HEX file format can be used.
PROM writer	Commercially available PROM writer

# 12 Communication Systems

System Applications .....	144
SYSMAC NET Token Ring Network .....	146
SYSMAC LINK Token Bus Network .....	148
SYSMAC WAY Host Link .....	150
PC Link System .....	152
SYSMAC BUS Remote I/O .....	153
Fiber-optic Communication Technology .....	155

**Plantwide Information Management and Control Networks**

Omron's advanced plantwide information management networks let you harness the power of valuable manufacturing and production data stored throughout your plant and turn it into a competitive advantage. Omron's fiber-optic based SYSMAC NET communications network links your supervisory computers and factory controllers in a seamless, high-speed, high-capacity network. Twin fiber-optic cables, automatic loopback, and a token ring configuration provide a reliable, deterministic interface to a variety of information systems.

SYSMAC NET's fast, 2 Mbps transmission speed and 2 Kb message size moves large amounts of data quickly.

**Distributed Control Networks**

By more tightly integrating their control systems, many manufacturers have been able to increase productivity and manufacturing flexibility. Omron's SYSMAC LINK distributed control network provides a high speed (2 Mbps) link for exchanging critical production data between supervisory computers and programmable controllers in real time.

The token bus peer-to-peer network uses noise resistant fiber-optic or low cost co-axial cable media for reliable, deterministic communications. A special data link feature provides an easy to set up, shared memory system for even tighter integration between multiple controls and computers.

**Man-Machine Interface Networks**

Omron's SYSMAC WAY Host Link serial network provides an ideal interface for today's data-hungry data acquisition and control software, or local operator interface. Multiple man-machine interfaces (MMI) can be connected to a PLC using the Host Link module.

Drivers for this openly available protocol have been developed for all major third-party operator interface and control software packages and operator interface devices.

**High-Speed Distributed I/O Systems**

Omron's SYSMAC BUS remote I/O system significantly lower wiring and maintenance costs. The high speed (187.5 Kpbs) system connect CPUs and distant I/O using low-cost twisted pair wiring or fiber-optic cables. Built-in diagnostics and status indicators simplify troubleshooting and maintenance.

Remote expansion racks, remote I/O blocks, programmable terminals, AC drives, pneumatic valves, and other devices can be connected to provide cost-effective distribution of I/O systems.

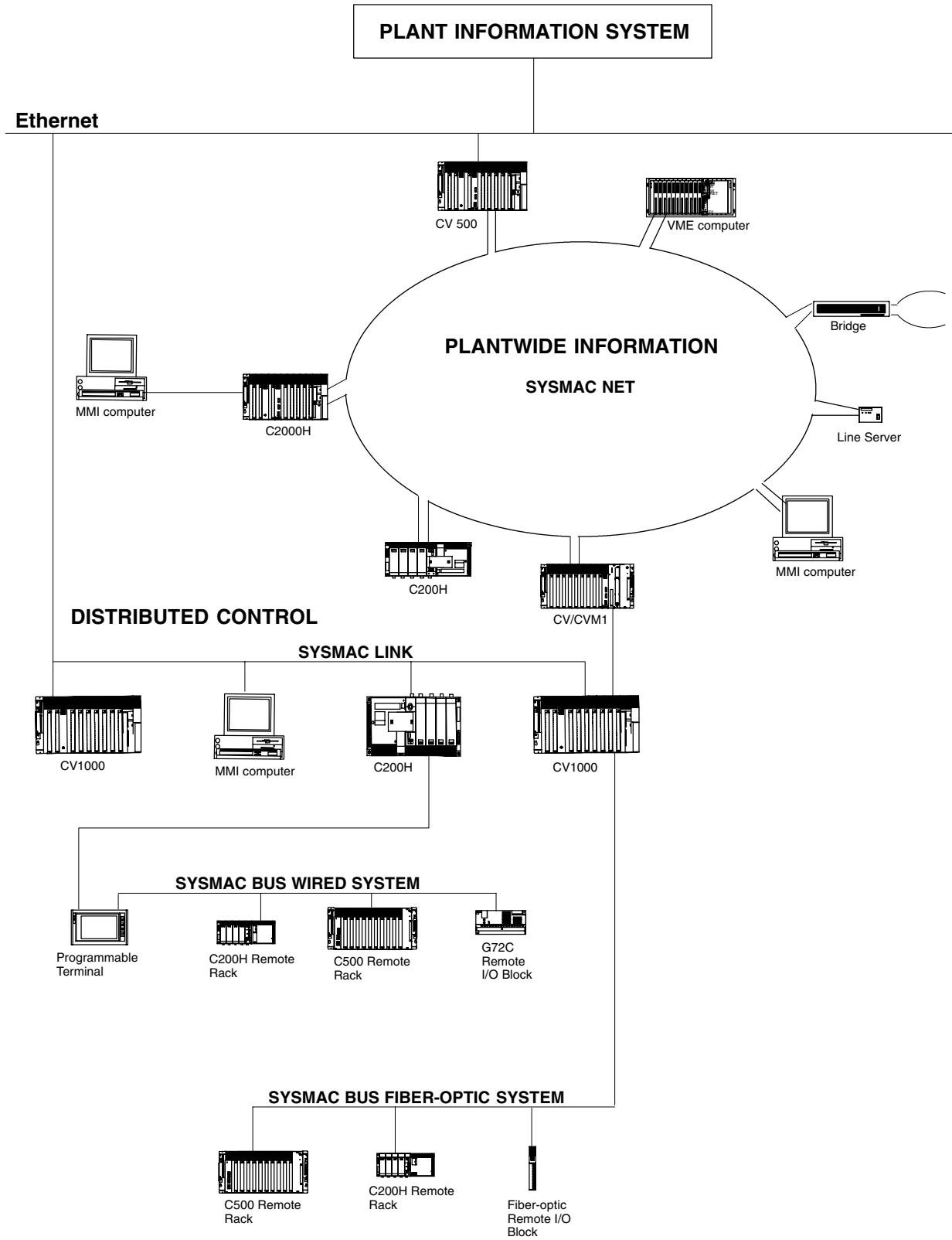

5

**General Information**

SYSMAC NET is a fiber-optic token ring network designed to transfer large amounts of data between PLCs, IBM PC/AT-compatible computers, VME computers, and any ASCII RS-232C devices. Network Bridges are also available to connect more than one SYSMAC NET loop. Any node in the network can initiate communications using simple program instructions. Fiber-optic transmission media provides reliable long distance communications in harsh environments. Automatic loopback, extensive diagnostics, and network utility software provide added reliability and ease of configuration.

- ◆ Token ring fiber-optic network with backloop redundancy
- ◆ Interface to PLCs, IBM PC/IBM PC/AT-compatible computers, VME computers, or any ASCII device
- ◆ TCP/IP protocol, 2 Mbps transmission speed

The following guidelines should be taken into account when configuring a SYSMAC NET network:

- ◆ At least one SYSMAC NET module per PLC system, two maximum per C200H System
- ◆ One SYSMAC NET Network Service board per computer
- ◆ One Line Server per network

**Specifications**

<b>Network topology</b>	Fiber-optic token ring
<b>Number of nodes</b>	126 nodes per loop
<b>Transmission media</b>	200 $\mu$ HPCF duplex fiber-optic cable
<b>Distance between nodes</b>	800 m (0.5 mile), 3 km (1.8 miles) with repeater
<b>Transmission speed</b>	2 Mbps
<b>Protocol</b>	TCP/IP
<b>PLC interfaces</b>	C200H, C500, C1000H, C2000H, CVM1, CV500, CV1000, CV2000
<b>Message size</b>	2 Kb maximum
<b>Network Service Boards</b>	AT bus, VME bus
<b>Network Service Units</b>	Serial computer interface, SYSMAC NET Bridge
<b>Diagnostics</b>	Automatic loopback, node bypass with UPS, self-diagnostic functions, error detection, network utility software

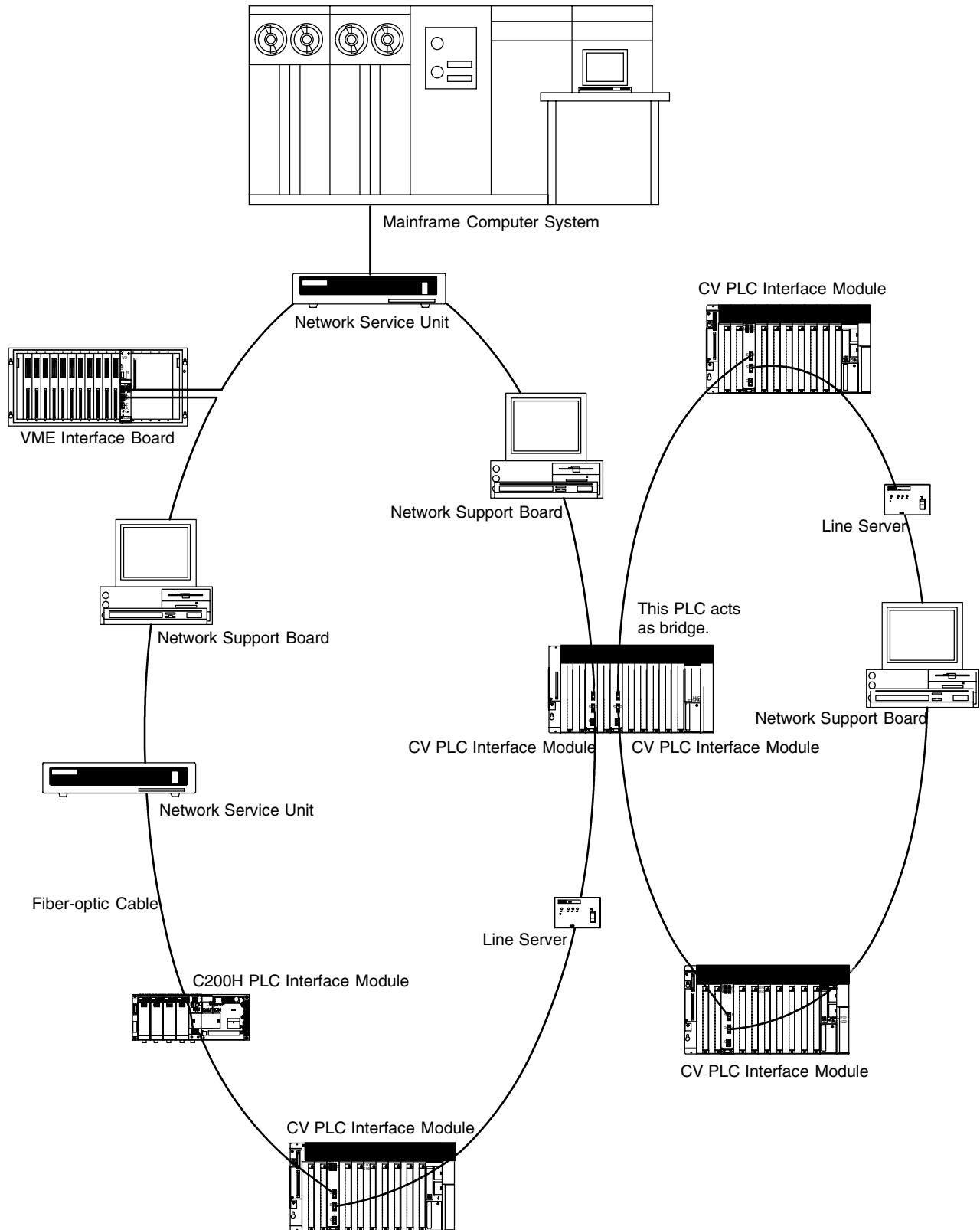

SYSMAC LINK is a high-speed token bus network designed to transfer large amounts of control data in real time between small and large rack PLCs. A variety of methods can be used to initiate communications between nodes; automatic data link allows transfer of data without any special programming; custom data link tables can be used for special data transfers between nodes. Each node can initiate transfers in send/receive mode using ladder logic instructions. This also allows each PLC to control communications and network data handling. Any node can be monitored or programmed using the Factory Intelligent Terminal (FIT) connected to a node on the network.

- ◆ High-speed token bus communications
- ◆ Large amounts of data transferred between PLCs or computers in a single command
- ◆ Automatic data link, custom data link, and peer-to-peer event communications options
- ◆ Send and receive instructions for PLC-initiated communications
- ◆ SYSMAC LINK can be connected to CV, C200H, C1000H, or C2000H simplex systems

The following guidelines should be taken into account when configuring a SYSMAC LINK network:

- ◆ At least one SYSMAC LINK module per PLC system
- ◆ One SYSMAC LINK Network Support Board per computer (co-axial only)

**Specifications**

<b>Network topology</b>	Token bus
<b>Number of nodes</b>	62 nodes per network
<b>Transmission media</b>	Wire: 75Ω impedance co-axial cable Fiber-optic: 200 μ HPCF duplex fiber-optic cable
<b>Distance</b>	Wire: 1 km (0.62 mile) total Fiber-optic: 800 m (0.5 mile) between nodes, 10 km (6.2 miles) total
<b>Transmission speed</b>	2 Mbps
<b>Functions</b>	Send, Receive, Deliver commands with FINS support (CV PLCs), automatic and custom data link
<b>PLC interfaces</b>	C200H, C1000H, C2000H, CVM1, CV500, CV1000, CV2000
<b>Message size</b>	512 bytes (256 words) maximum
<b>Data link capacity per node</b>	Link relay area: 64 words (128 bytes) Data memory area: 254 words (508 bytes)
<b>Data link capacity per network</b>	
<b>C200H</b>	918 words max.
<b>C1000H, C2000H</b>	2966 words max.
<b>CV500, CV1000</b>	2966 words max.
<b>Diagnostics</b>	Transmission path backup (fiber-optic backloop), failed node bypass, polling link backup, self-diagnostic and echo-back test, watchdog timer, error detection



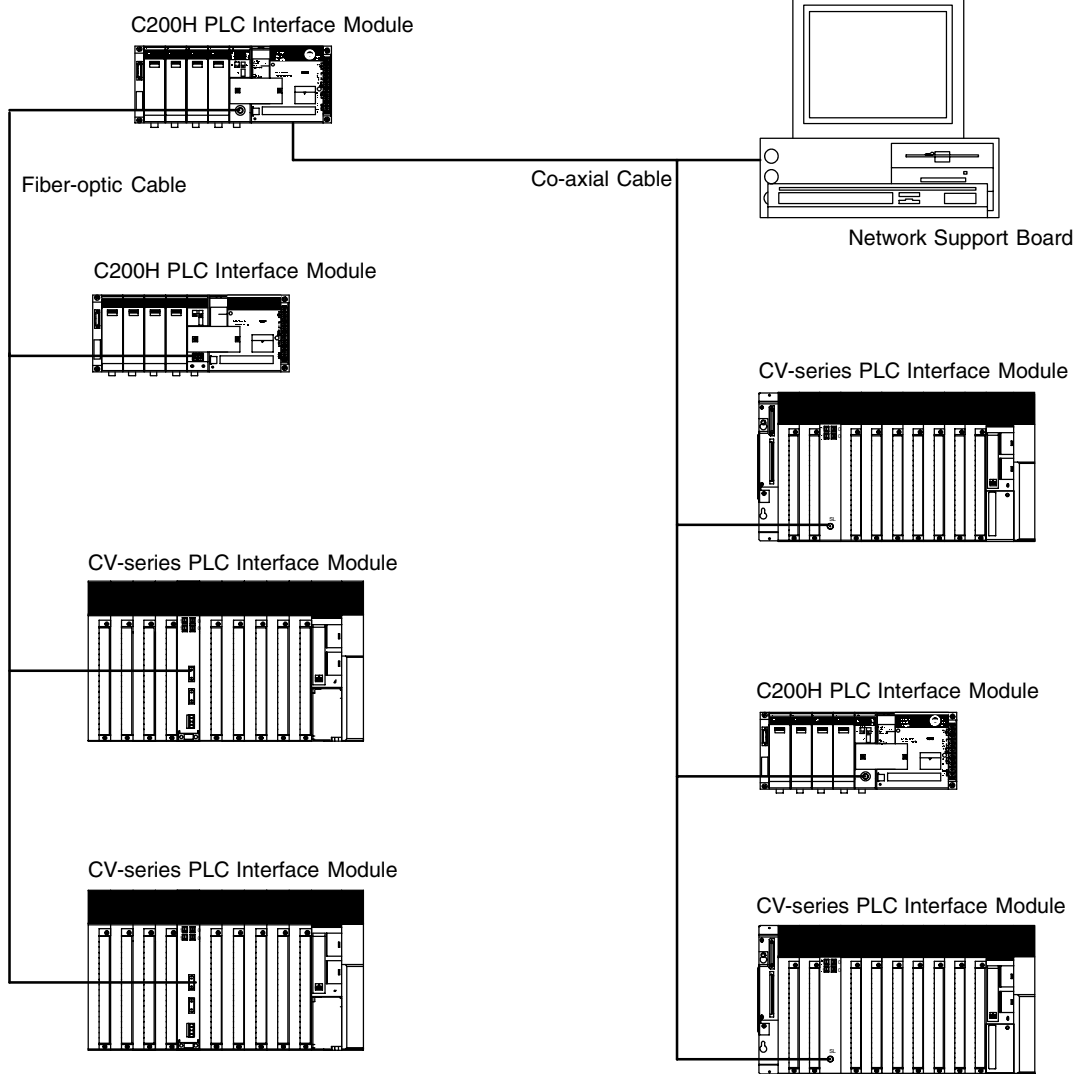

Host Link allows any computer to communicate with one (RS-232C), or several (RS-422) Omron PLCs. Multiple system levels can be connected to the same PLC with up to 32 PLCs connected to one computer. Omron's Host Link protocol is well defined and available for custom software driver development and operator interface connection to Omron PLCs. Most major operator interface companies have Host Link interfaces and drivers available. Host Link systems allow using Ladder Support Software (LSS) to program and monitor any PLC in the system.

The Host Link protocol is common to all Omron PLCs including the C20, K-type, Block-style H-type, C200H, C1000H, C2000H, and CV-series PLCs.

- ◆ Up to 32 PLCs can be connected to a single host computer
- ◆ Twisted pair or fiber-optic transmission media

The following guidelines should be taken into account when configuring a Host Link system:

- ◆ The computer must have one serial port available
- ◆ If a fiber-optic, or RS-422 Host Link module is used, Link Adapters must be included in the system

**Specifications**

<b>Communications protocol</b>	Software: Omron host link protocol Hardware: RS-232C, RS-422 multi-drop; fiber-optic, or combination using Omron Link Adapters
<b>Synchronization</b>	Start-stop (1 or 2 stop bits)
<b>Distance</b>	RS-232C: 15 m (49 ft.) maximum RS-422: 10 m (32.8 ft.) maximum for any one cable Distances can be extended using Link Adapters
<b>Transmission speed</b>	300, 600, 1200, 2400, 4800, 9600, 19,200 bps (switch-selectable)
<b>PLC interfaces</b>	C20, K-type, Block-style H-type (built-in), C200H, C500, C1000H, C2000H, CVM1, CV500, CV1000, CV2000
<b>Character code</b>	ASCII (7 bits) or JIS (8 bits)
<b>Error check</b>	Parity and frame check sum
<b>Functions</b>	Program upload/download, PLC status control, error handling, read (any) memory area, write (any) memory area, read timer/counter, write timer/counter, etc.

### System Configuration

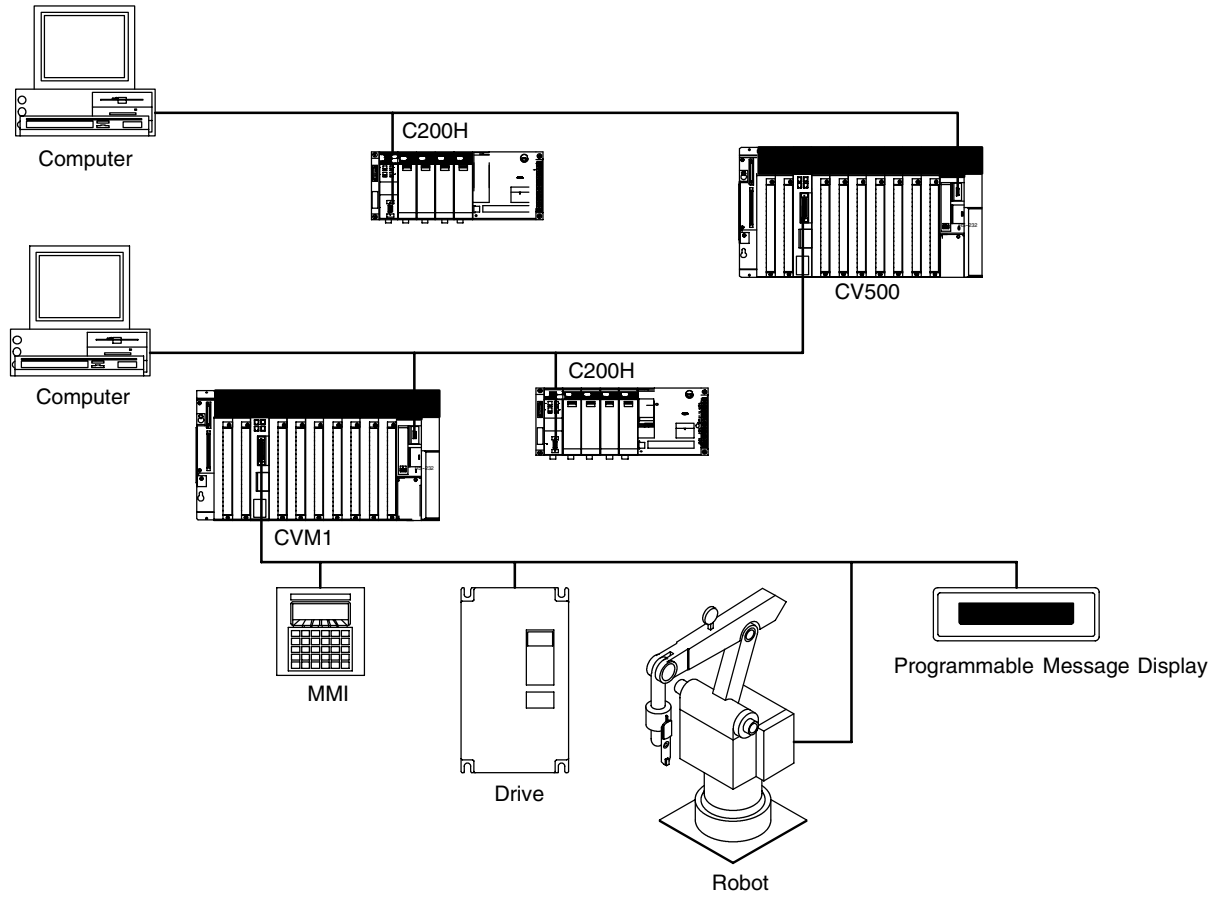

### General Information

PC Link is a peer-to-peer communication system allowing high-speed transfer of data between PLCs over long distances. Both small and large rack PLCs can be connected to the same system. Standard Link Adapters are available for fiber-optic media and longer transmission distances. No special programming is required to transfer data and multi-level systems can be connected to a single PLC.

### Features

- ◆ High-speed data transfer between up to 32 PLCs
- ◆ No special programming required
- ◆ Multi-level capability

### Specifications

<b>Communication method</b>	Peer-to-peer					
<b>Network topology</b>	Multi-drop using Omron Link Adapters					
<b>Number of nodes</b>	PLC of polling link	Single-level	Multi-level			
	C200H, C1000H, C2000H	32	16			
	C500	8	8			
<b>Transmission media</b>	Twisted pair; fiber-optic when using Omron Link Adapters					
<b>Distance</b>	500 m (1640 ft) total cable length (without fiber-optic links), including branch lines Distances can be extended using Link Adapters					
<b>Transmission speed</b>	128 kbps					
<b>Protocol</b>	Omron PC Link, RS-485					
<b>PLC interfaces</b>	C200H, C500, C1000H, C2000H					
<b>Data transfer capacity (bits/node)</b>	PLC of polling link	2 links	3-4 links	5-8 links	9-16 links	17-32 links
	C200H, C1000H, C2000H	512	256	128	64	32
	C500	256	128	64	—	—
<b>Diagnostic functions</b>	CPU watchdog timer, CRC transmission error check					

### System Configuration

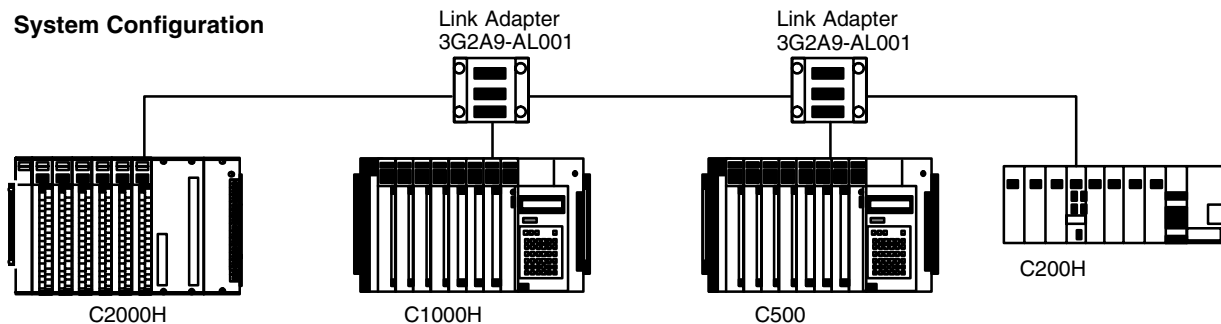

### General Information

The SYSMAC BUS Remote I/O system is ideal for distribution of I/O and other devices at long distances from the CPU. Multiple remote I/O systems can be connected to a single CPU allowing maximum configuration flexibility.

A SYSMAC BUS Remote I/O system consists of a Remote Master and one or more Remote Slave modules. Both small and large rack-style I/O can be mixed in the same remote I/O system. Remote terminal blocks allow for distribution of 8- and 16-point I/O blocks in a wired remote I/O system. Stand-alone fiber-optic I/O modules allow distribution of 8-point I/O blocks in a fiber-optic remote I/O system. I/O Link modules allow connection of a K-type PLC to a fiber-optic remote I/O system. Special link adapters are available for extended distances and mixing media types.

### Features

- ◆ Wired twisted pair or fiber-optic cable versions
- ◆ Variety of I/O styles and types in a given remote I/O system
- ◆ RS-485 communications at 187.5 Kbps
- ◆ Connect C200H I/O, C500 I/O, G7 remote I/O terminals, programmable terminals

### Specifications

<b>PLC</b>	<b>C200H-RM001/RM002</b>
<b>Masters per PLC</b>	2
<b>Remote expansion racks per master</b>	5 Slaves per PLC max
<b>Remote I/O devices per master</b>	Up to 32
<b>I/O points per master</b>	512
<b>I/O points per PLC</b>	512

**SYSMAC BUS Fiber-optic System**

**SYSMAC BUS Wired System**

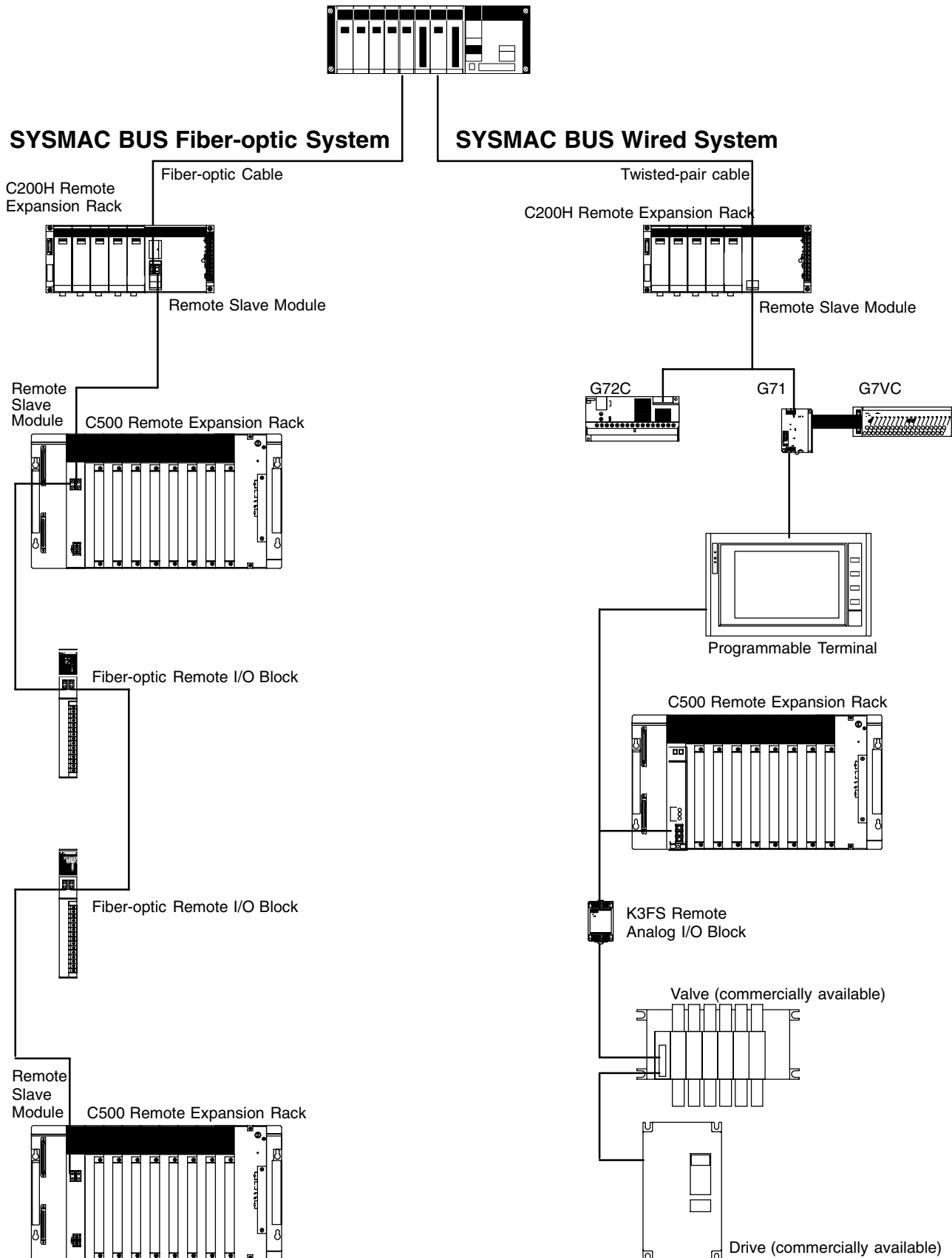

5

### General Information

Omron pioneered the use of fiber-optics for factory floor communications in 1985 by introducing standard fiber-optic interfaces for Remote I/O and all Omron industrial communications networks. Fiber-optic communications offer distinct advantages over conventional wiring, including electrical noise immunity and increased transmission distances.

Recent developments in fiber-optic and communications technology have provided a variety of cost-effective and easy-to-install solutions. Simple field termination, lower cable costs and a variety of fiber-optic cable types allow for the effective use of fiber-optic communications in most industrial applications.

Omron offers a variety of standard direct-connect fiber-optic modules for fiber-optic communications. Two types of modules are available: -P suffix types are for use with APF, HPCF and PCF Cable types. Non -P suffix types are for use with HPCF and PCF Cable types. Both of these module types accept the fiber-optic cable directly. No adapter is needed.

### All Plastic Fiber (APF)

All Plastic Fiber is ideal for short transmission distances up to 20 meters in remote I/O, or Host Link communications. Field termination requires no special tools or skills. APF requires the use of -P modules. The connectors used with APF are the 3G5A2 connectors.

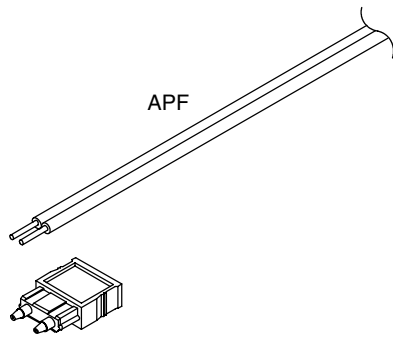

### Hard Plastic-clad Fiber (HPCF)

Hard Plastic-clad Fiber has a 200 micron core cable for maximum distances of up to 200 meters without repeaters. It is available in both a zipcord style and a reinforced plastic-jacketed style with stress relief for pulling through conduit. A termination tool kit is required for field terminations. Bulk cable lengths up to 1 km are available. The connectors used with HPCF are the S3200 connectors.

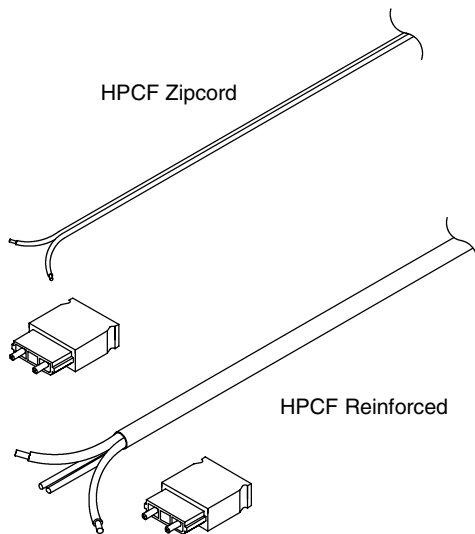

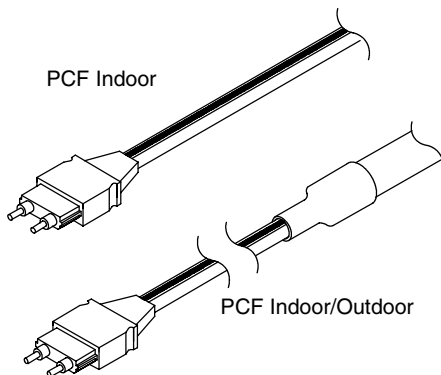

**Plastic-clad Fiber (PCF)**

Plastic-clad Fiber is a high performance fiber allowing maximum distances of up to 800 meters (0.5 mile) without repeaters. Pre-terminated lengths from 0.1 to 800 meters are available. Connector bodies can be easily removed for running cable through ducts, then re-assembled.

**All Glass Crystal Fiber (AGF)**

Special cable and configurations are available for longer distance requirements, up to 3 km. The maximum transmission distance with each type of fiber-optic cable is determined by the kind of Remote I/O or Host Link modules used. These modules either have a -P or no -P in the part number. The table below shows maximum transmission distances. Longer distances are possible using standard repeaters.

**System Compatibility**

The following table shows which Fiber-optic Cable can be used with each system. The table also shows the maximum length of each Cable.

Fiber-optic Cable	APF	HPCF	PCF
<b>SYSMAC BUS with -P modules</b>	20 m (65 ft.)	100 m (328 ft.)	200 m (656 ft.)
<b>SYSMAC BUS with non -P modules</b>	—	200 m (656 ft.)	800 m (0.5 mile)
<b>SYSMAC WAY with -P modules (C-series only)</b>	20 m (65 ft.)	100 m (328 ft.)	200 m (656 ft.)
<b>SYSMAC WAY with non -P modules (C-series only)</b>	—	200 m (656 ft.)	800 m (0.5 mile)
<b>SYSMAC NET</b>	—	800 m (0.5 mile)	1000 m (0.62 mile)

**S3200 Connectors**

S3200 is the part number prefix. Refer to Standard Parts for complete part numbers.

	SYSMAC NET	SYSMAC LINK	SYSMAC WAY	SYSMAC BUS/2	SYSMAC BUS
<b>C200H</b>	COCF2511	COCF2511	COCH82	—	COCH82
<b>C1000H, C2000H</b>	COCH62M	COCF2011	COCH82	—	COCH82
<b>CVM1, CV500, CV1000, CV2000</b>	COCF2011	COCF2011	COCF2011	COCF2011	COCF2011
<b>SYSMAC NET Network Support Board</b>	COCH62M	—	—	—	—
<b>SYSMAC NET Line Server</b>	COCH62M	—	—	—	—
<b>SYSMAC NET Bridge</b>	COCH62M	—	—	—	—
<b>SYSMAC NET Network Service Unit</b>	COCH62M	—	—	—	—
<b>SYSMAC NET VME Interface</b>	COCH62M	—	—	—	—

**3G5A2 Connectors (-P modules only)**

3G5A2 is the part number prefix. B500 part number prefixes are equivalent to 3G5A2 prefixes. Refer to Standard Parts for complete part numbers.

	SYSMAC WAY	SYSMAC BUS
<b>C200H</b>	CO001, CO002	CO001, CO002
<b>C1000H, C2000H</b>	CO001, CO002	CO001, CO002
<b>CVM1, CV500, CV1000, CV2000</b>	—	CO001, CO002



Name	Description	Part Number
<b>All Plastic Fiber-optic (APF) Cable</b>		
Fiber-optic Cable	20 m (65.6 ft.), without connectors	B500-PF212
Fiber-optic Connectors	Brown, for cable 0 to 10 m (0 to 32.8 ft.) long (includes 2)	3G5A2-CO001
	Black, for cable 8 to 20 m (0 to 65.6 ft.) long (includes 2)	3G5A2-CO002
<b>Hard Plastic-Clad Fiber-optic (HPCF) Cable</b>		
Fiber-optic Cable	50 m (164 ft.), without connectors	FCS-HCR-LB-501
	100 m (328 ft.), without connectors	FCS-HCR-LB-102
	500 m (0.31 mile), without connectors	FCS-HCR-LB-502
	1 km (0.62 mile), without connectors	FCS-HCR-LB-103
	Zipcord style, orange, 50 m (164 ft.), without connectors	FCS-HCR-CO-501
Fiber-optic Connectors	SYSMAC BUS or SYSMAC WAY only	S3200-COCH82
	SYSMAC BUS/2 (all PLCs), SYSMAC LINK (other than C200H)	S3200-COCF2011
	SYSMAC NET (other than C200H)	S3200-COCH62M
	SYSMAC NET, LINK (C200H only)	S3200-COCF2511
In-line Fiber-optic Connectors	SYSMAC NET In-line male connector	S3200-COCF62M
	SYSMAC NET In-line female connector	S3200-COCF62F
	SYSMAC LINK In-line adapter	S3200-COIA2000
Termination Kit	For HPCF Cable	FCS-CAK6230-US
<b>Plastic-Clad Fiber-optic (PCF) Cable</b>		
Indoor Fiber-optic Cable	10 cm (0.32 ft.), with connectors	3G5A2-OF011
	1 m (3.2 ft.), with connectors	3G5A2-OF101
	2 m (6.56 ft.), with connectors	3G5A2-OF201
	3 m (9.8 ft.), with connectors	3G5A2-OF301
	5 m (16.4 ft.), with connectors	3G5A2-OF501
	10 m (32.8 ft.), with connectors	3G5A2-OF111
	20 m (65.6 ft.), with connectors	3G5A2-OF211
	30 m (98 ft.), with connectors	3G5A2-OF311
	50 m (164 ft.), with connectors	3G5A2-OF511
Indoor/Outdoor Fiber-optic Cable	100 m (328 ft.), with connectors	3G5A2-OF002-100M
	200 m (656 ft.), with connectors	3G5A2-OF002-200M
	400 m (0.25 mile), with connectors	3G5A2-OF002-400M
	800 m (0.5 mile), with connectors	3G5A2-OF002-800M



# 13 Standard Parts

CPU Rack and Local Expansion Rack .....	160
Backplane, Rack Accessories and Replacement Parts .....	161
SYSMAC BUS .....	162
Special I/O Modules and Accessories .....	164
Discrete I/O Modules .....	166
I/O Module Accessories, I/O Wiring Accessories .....	167
I/O Wiring Accessories .....	168
I/O Wiring Accessories, Power Supplies .....	171
Communication Modules and Accessories .....	172
Peripheral Software, Devices, and Accessories .....	173
Fiber-optic Cables .....	174
Manuals .....	175

**CPU Rack**

Name	Description	Part number
<b>Required Parts</b>		
CPU	C200H AC power supply	C200H-CPU01-E
	C200H DC power supply	C200H-CPU03-E
	C200H AC power supply	C200H-CPU21-E
	C200H DC power supply	C200H-CPU23-E
	C200H AC power supply with clock; SYSMAC NET/LINK capable	C200H-CPU31-E
	C200HS AC power supply	C200HS-CPU01-E
	C200HS DC power supply	C200HS-CPU03-E
	C200HS AC power supply, RS-232C Port	C200HS-CPU21-E
	C200HS DC power supply, RS-232C Port	C200HS-CPU23-E
	C200HS AC power supply, SYSMAC NET/LINK capable, RS-232C Port	C200HS-CPU31-E
	C200HS DC power supply, SYSMAC NET/LINK capable, RS-232C Port	C200HS-CPU33-E
CPU Backplane	3-slot backplane	C200H-BC031-V2
	5-slot backplane	C200H-BC051-V2
	8-slot backplane	C200H-BC081-V2
	10-slot backplane	C200H-BC101-V2
Memory Packs (Not required for C200HS)	RAM, 4 K words, battery back-up; no clock	C200H-MR431
	RAM, 8 K words, battery back-up; no clock	C200H-MR831
	RAM, 4 K words, capacitor back-up; no clock	C200H-MR432
	RAM, 8 K words, capacitor back-up; no clock	C200H-MR832
	RAM, 4 K words, battery back-up; with clock (CPU21, CPU23 only)	C200H-MR433
	RAM, 8 K words, battery back-up; with clock (CPU21, CPU23 only)	C200H-MR833
	EPROM, 8 K words, no clock	C200H-MP831
	EEPROM, 4 K words, no clock	C200H-ME431
	EEPROM, 8 K words, no clock	C200H-ME831
	EEPROM, 4 K words, battery back-up; with clock (CPU21, CPU23 only)	C200H-ME432
	EEPROM, 8 K words, battery back-up; with clock (CPU21, CPU23 only)	C200H-ME832
<b>Optional Parts</b>		
File Memory Boards (C200HS only)	EPROM, 16K words	C200HS-MP16K
	EEPROM, 16K words	C200HS-ME16K

**Local Expansion Rack**

Name	Description	Part number
<b>Required Parts</b>		
CPU Backplane	3-slot backplane	C200H-BC031-V2
	5-slot backplane	C200H-BC051-V2
	8-slot backplane	C200H-BC081-V2
	10-slot backplane	C200H-BC101-V2
Power supply	24 VDC	C200H-PS211
	120/240 VAC	C200H-PS221
Local Expansion I/O Connecting Cable	30 cm (11.8 in.)	C200H-CN311
	70 cm (2.3 ft.)	C200H-CN711
	2 m (6.6 ft.)	C200H-CN221
	5 m (16.4 ft.)	C200H-CN521
	10 m (32.8 ft.)	C200H-CN131

6

Name	Description	Part number
Back-up Battery	Replacement for memory	C200H-BAT09
I/O Simulator	For programming and debugging, requires ID001; 8 inputs	C200H-ETL01
Space Module	For I/O Module slots	C200H-SP001
Backplane Connector Cover	For I/O Module connectors	3G2A5-COV02
I/O Terminal Block Cover	For 10-pin I/O Terminal Blocks	C200H-COV02
	For 19-pin I/O Terminal Blocks	C200H-COV03
	For 5- and 8-point Modules	C200H-COV11
DIN Rail Adapter Kit	For mounting Backplane to DIN rail (includes two pieces)	C200H-DIN01
DIN Rail	Track, 50 cm (1.6 ft.)	PFP-50N
	Track, 1 m (3.2 ft.)	PFP-100N
	End Plate	PFP-M
	Spacer	PFP-S
Backplane Isolating Panel	For 3-slot Backplane	C200H-ATT31
	For 5-slot Backplane	C200H-ATT51
	For 8-slot Backplane	C200H-ATT81
I/O Mounting Bracket	For 3-slot rack	C200H-ATT33
	For 5-slot rack	C200H-ATT53
	For 8-slot rack	C200H-ATT83

**SYSMAC BUS Remote I/O Control Modules**

Name	Description	Part number
<b>SYSMAC BUS Remote Master Modules</b>		
Remote Master	Fiber-optic: APF, PCF, HPCF (1 port)	C200H-RM001-P
	Wired	C200H-RM201
<b>C200H SYSMAC BUS Remote Expansion Rack Backplanes and Power Supply/Slaves</b>		
Backplane	3-slot	C200H-BC031-V2
	5-slot	C200H-BC051-V2
	8-slot	C200H-BC081-V2
	10-slot	C200H-BC101-V2
Power Supply/Remote Slave	Fiber-optic: APF, PCF, HPCF (1 port) 120 VAC	C200H-RT001-P
	Fiber-optic: APF, PCF, HPCF (1 port) 24 VDC	C200H-RT002-P
	Wired, 120 VAC	C200H-RT201
	Wired, 24 VDC	C200H-RT202
<b>C500 SYSMAC BUS Remote Expansion Rack Backplanes, Power Supplies and Slaves</b>		
Backplane	3 I/O slots	C500-BL031
	5 I/O slots	3G2A5-BI051
	8 I/O slots	3G2A5-BI081
Power Supply	120/240 VAC	3G2A5-PS222-E
	24 VDC	3G2A5-PS212-E
Remote Slave Module	Fiber-optic: PCF, HPCF (1 port)	3G2A5-RT001-EV1
	Fiber-optic: APF, PCF, HPCF (1 port)	3G2A5-RT001-PEV1
	Fiber-optic: PCF, HPCF (2 ports)	3G2A5-RT002-EV1
	Fiber-optic: APF, PCF, HPCF (2 ports)	3G2A5-RT002-PEV1
	Wired	C500-RT201

**SYSMAC BUS Remote I/O Devices**

**SYSMAC BUS Fiber-optic Remote I/O Blocks**

Description	Fiber-optic Cable type	Points	Part number
120 VAC input	PCF, HPCF	8	3G5A2-IA121-E
240 VAC input	PCF, HPCF	8	3G5A2-IA221-E
Non-voltage contact input	PCF, HPCF	8	3G5A2-ID001-E
Non-voltage contact input	APF, PCF, HPCF	8	3G5A2-ID001-PE
12 to 24 VAC/DC input	PCF, HPCF	8	3G5A2-IM211-E
Triac output, 120 VAC	PCF, HPCF	8	3G5A2-OA121-E
Triac output, 1 A, 85 to 250 VAC	PCF, HPCF	8	3G5A2-OA222-E
Relay output, 2 A, 24 VDC/250 VAC	PCF, HPCF	8	3G5A2-OC221-E
Relay output, 2 A, 24 VDC/250 VAC	APF, PCF, HPCF	8	3G5A2-OC221-PE
Transistor output, 0.3 A, 12 to 48 VDC	PCF, HPCF	8	3G5A2-OD411-E
Transistor output, 0.3 A, 12 to 48 VDC	APF, PCF, HPCF	8	3G5A2-OD411-PE

## G72C SYSMAC BUS Remote I/O Blocks

Power supply	Input voltage/ Switching capacity	Internal circuit	Points	Part number
<b>SYSMAC BUS Remote Input Blocks</b>				
24 VDC (200 mA, max.)	9.7 mA, 24 VDC/pt	NPN, positive common	16	G72C-ID16-DC24V
24 VDC (200 mA, max.)	9.7 mA, 24 VDC/pt	PNP, negative common	16	G72C-ID16-1-DC24V
24 VDC (200 mA, max.)	9.7 mA, 24 VDC/pt	NPN, positive common	16	G72C-VID16-DC24
<b>SYSMAC BUS Remote Output Blocks</b>				
24 VDC (200 mA, max.)	0.3 A, 24 VDC/point	NPN, positive common	16	G72C-OD16-DC24V
24 VDC (200 mA, max.)	0.3 A, 24 VDC/point	PNP, negative common	16	G72C-OD16-1-DC24V
24 VDC (200 mA, max.)	0.3 A, 24 VDC/point 2.4 A/Terminal	NPN, negative common	16	G72C-VOD16-DC24

## G71 SYSMAC BUS Remote Stand-alone Slaves

These Interfaces are used with the G7TC, G7VC, and P7TF I/O Blocks (1 Block/Interface).

Power supply	Internal circuit	Points	Part number
<b>SYSMAC BUS Remote Input Stand-alone Slave</b>			
24 VDC (200 mA, max.) supplied through Input Block		16	G71-IC16-DC24V
<b>SYSMAC BUS Remote Output Stand-alone Slave</b>			
24 VDC (500 mA, max.) supplied through Output Block		16	G71-OD16-DC24V

Description	Part number
<b>ASCII/BASIC Coprocessor</b>	
PLC module (rack-mount); EEPROM; RS-232C	C200H-ASC02
ASCII/BASIC module Utility Software	SYSMATE-ASC91-V1
Battery set for PLC module	C200H-BAT09
<b>Analog Input Modules</b>	
4 pts.; 4 to 20 mA, 1 to 5 V, 0 to 10V	C200H-AD001
2 pts.; 0 to 10 V	C200H-AD002
<b>Analog Output Modules</b>	
2 pts.; 4 to 20 mA, 1 to 5 V, 0 to 10V	C200H-DA001
<b>High-speed Counter</b>	
PLC module (rack-mount); up to 50 kHz; up to 5 m	C200H-CT001-V1
PLC module (rack-mount); up to 75 kHz; up to 25 m	C200H-CT002
<b>1-axis Position Control</b>	
PLC module (rack-mount); 1 axis	C200H-NC112
<b>2-axis Position Control</b>	
PLC module (rack-mount); 2 axis	C200H-NC211
<b>Temperature Sensor Input Modules</b>	
PLC module (rack-mount); type J and K thermocouples	C200H-TS001
PLC module (rack-mount); platinum RTD	C200H-TS101
<b>Temperature Controller Modules</b>	
PLC modules (rack-mount) Thermocouple	C200H-TC001/002/003
PLC modules (rack-mount) platinum RTD	C200H-TC101/102/103
<b>Heat/Cool Temperature Controller Modules</b>	
PLC modules (rack-mount) Thermocouple	C200H-TV001/002/003
PLC modules (rack-mount) platinum RTD	C200H-TV101/102/103
<b>PID Control</b>	
PLC modules (rack-mount)	C200H-PID-01/02/03
<b>Voice</b>	
PLC module (rack-mount)	C200H-OV001
RS-232C cable for message transfer between module and computer	C200H-CN224
<b>Analog Timer Input Module</b>	
PLC module (rack-mount); 4 timers, externally set values	C200H-TM001
Variable resistor connector cable	C4K-CN223



Description	Part number
<b>Cam Positioner</b>	
PLC module (rack-mount)	C200H-CP114
Resolver with 1 m (3.28 ft.) cable	3F88L-RS17
Resolver cable, 3 m (9.84 ft.)	3F88L-CR003C
Resolver cable, 5 m (16.4 ft.)	3F88L-CR005C
Resolver cable, 10 m (32.8 ft.)	3F88L-CR010C
Resolver cable, 20 m (65.6 ft.)	3F88L-CR020C
Resolver shaft coupler	3F88L-RL10
<b>Radio Frequency Identification Systems (V600 Short-range RF ID Systems)</b>	
PLC module (rack-mount)	C200H-IDS01-V1
<b>Radio Frequency Identification Systems (V620 Long-range RF ID Systems)</b>	
PLC module (rack-mount)	C200H-IDS21
<b>Interrupt Input</b>	
PLC module, (rack-mount); 8 inputs, 12 to 24 VDC (C200HS CPU only)	C200HS-INT01
<b>Fuzzy Inferencing Coprocessor</b>	
PLC module, (rack-mount); 8 inputs, 2 outputs	C200HS-FZ001

## Special High-density I/O Modules

Voltage	Points (/common)	Part number
5 VDC TTL	32 (8/common, 4 circuits), 8 points can be quick-reponse	C200H-ID501
24 VDC	32 (8/common, 4 circuits), 8 points can be quick-reponse	C200H-ID215
5 VDC TTL	32 (8/common, 4 circuits), or 128 multiplexed, selectable	C200H-OD501
24 VDC	32 (8/common, 4 circuits), or 128 multiplexed, selectable	C200H-OD215
Input: 5 VDC Output: 5 VDC	16 inputs & 16 outputs (8/common, 2 circuits each), or 128 dynamic multiplexed inputs, selectable; 8 points can be quick-reponse in static mode	C200H-MD501
Input: 12 VDC Output: 5 to 24 VDC	16 inputs & 16 outputs (8/common, 2 circuits each), or 128 dynamic multiplexed inputs, selectable; 8 points can be quick-reponse in static mode	C200H-MD115
Input: 24 VDC Output: 5 to 24 VDC	16 inputs & 16 outputs (8/common, 2 circuits each), or 128 dynamic multiplexed inputs, selectable; 8 points can be quick-reponse in static mode	C200H-MD215

## Group 2 High-Density I/O Modules for CPU21, CPU23, CPU31, and HS only

Voltage	Description	Part number
24 VDC	32 (32/common, 1 circuit)	C200H-ID216
24 VDC	64 (32/common, 2 circuits)	C200H-ID217
4.5 VDC to 26.4 VDC	32 (32/common, 1 circuit)	C200H-OD218
4.5 VDC to 26.4 VDC	64 (32/common, 2 circuits)	C200H-OD219

### Discrete Input Modules

Voltage	Points (/common)	Part number
<b>DC Inputs</b>		
12 to 24 VDC	8 (8/common, 1 circuit)	C200H-ID211
24 VDC	16 (16/common, 1 circuit)	C200H-ID212
<b>AC Inputs</b>		
100 to 120 VAC	8 (8/common, 1 circuit)	C200H-IA121
100 to 120 VAC	16 (16/common, 1 circuit)	C200H-IA122
200 to 240 VAC	8 (8/common, 1 circuit)	C200H-IA221
200 to 240 VAC	16 (16/common, 1 circuit)	C200H-IA222
<b>AC/DC Inputs</b>		
12 to 24 VAC/VDC	8 (8/common, 1 circuit)	C200H-IM211
24 VAC/VDC	16 (16/common, 1 circuit)	C200H-IM212

### Discrete Output Modules

Current/voltage	Points (/common)	Part number
<b>Transistor Outputs</b>		
0.3 A, 5 to 24 VDC	8 (8/common, 1 circuit), PNP	C200H-OD216
0.3 A, 12 to 24 VDC	12 (12/common, 1 circuit), PNP	C200H-OD217
1 A, 12 to 24 VDC	8 (8/common, 1 circuit)	C200H-OD411
0.3 A, 24 VDC	12 (12/common, 1 circuit)	C200H-OD211
0.3 A, 24 VDC	16 (16/common, 1 circuit)	C200H-OD212
0.8 A, 24 VDC	8 (8/common, 1 circuit)	C200H-OD214
2.1 A, 24 VDC	8 (8/common, 1 circuit)	C200H-OD213
<b>Triac Outputs</b>		
120 VAC	8 (8/common, 1 circuit)	C200H-OA121-E
250 VAC	8 (8/common, 1 circuit)	C200H-OA221
250 VAC	12 (12/common, 1 circuit)	C200H-OA222
<b>Relay Outputs</b>		
24 VDC/250 VAC	5 (independent commons)	C200H-OC223
24 VDC/250 VAC	8 (independent commons)	C200H-OC224
24 VDC/250 VAC	8 (8/common, 1 circuit)	C200H-OC221
24 VDC/250 VAC	12 (12/common, 1 circuit)	C200H-OC222
24 VDC/250 VAC	16 (16/common, 1 circuit)	C200H-OC225

### I/O Module Accessories

Name	Description	Part number
I/O Terminal BLock Cover	For 10 pin I/O Terminal Blocks	C200H-COV02
	For 19 pin I/O Terminal Blocks	C200H-COV03
	For 5- and 8- point Modules	C200H-COV11
Connector	24-pin, solder type, straight	C500-CE241
	24-pin, crimp type	C500-CE242
	24-pin, for ribbon cable	C500-CE243
	24-pin, solder type, 90° angle	C500-CE244
	40-pin, solder type, straight	C500-CE401
	40-pin, crimp type	C500-CE402
	40-pin, for ribbon cable	C500-CE403
	40-pin, solder type, 90° angle	C500-CE404
	RS-232C, 25 pins	0020756-4, RS-232 connector
	RS-422, 9 pins	0020757-2, RS-422 connector
Connector Cover	RS-232C, 25 pins	0020758-0, RS-232 cover
	RS-422, 9 pins	0020759-9, RS-422 cover

### XW2B Screw Terminals

Description	Screw size	Part number
<b>Blocks for 32-point I/O Modules</b>		
20 terminals	M2.4	XW2B-20G4
20 terminals	M3.5	XW2B-20G5
40 terminals (2 connectors)	M3.5	XW2B-40G5-T
20 terminals (daisy chain applications)	M3.5	XW2B-20G5-D
<b>Blocks for 64-point I/O Modules</b>		
40 terminals	M2.4	XW2B-40G4
40 terminals	M3.5	XW2B-40G5

### Connecting Cables for XW2B Screw Terminals

Description	Length	Part number
For 32-point blocks	1 m (3.28 ft.)	XW2Z-100A
	2 m (6.56 ft.)	XW2Z-200A
	3 m (9.84 ft.)	XW2Z-300A
	5 m (16.4 ft.)	XW2Z-500A
For 64-point blocks	1 m (3.28 ft.)	XW2Z-100B
	2 m (6.56 ft.)	XW2Z-200B
	3 m (9.84 ft.)	XW2Z-300B
	5 m (16.4 ft.)	XW2Z-500B

### Output Connectors, Input Blocks

#### B7A Output Connectors

Rated load voltage	Rated load current	Output configuration	I/O delay	Error processing	Points	Part number
5 to 24 VDC	50 mA max./point	NPN open collector	Normal-speed 19.2 ms	Hold	16	B7A-R6A13
5 to 24 VDC	50 mA max./point	NPN open collector	Normal-speed 19.2 ms	Load OFF	16	B7A-R6A33
5 to 24 VDC	50 mA max./point	NPN open collector	High-speed 3 ms	Hold	16	B7A-R6A18
5 to 24 VDC	50 mA max./point	NPN open collector	High-speed 3 ms	Load OFF	16	B7A-R6A38
5 to 24 VDC	50 mA max./point	NPN open collector	Normal-speed 19.2 ms	Hold	32	B7A-R3A13
5 to 24 VDC	50 mA max./point	NPN open collector	Normal-speed 19.2 ms	Load OFF	32	B7A-R3A33
5 to 24 VDC	50 mA max./point	NPN open collector	High-speed 3 ms	Hold	32	B7A-R3A18
5 to 24 VDC	50 mA max./point	NPN open collector	High-speed 3 ms	Load OFF	32	B7A-R3A38

**B7A Input Blocks**

Input configuration	Input voltage	Input current range	Input voltage range	I/O delay	Common	Pts	Part number
NPN compatible	No-voltage contact, two-wire sensors with DC output, NPN output type	3 to 6 mA	0 VDC to supply voltage	Normal-speed 19.2 ms	- common	16	B7A-T6A1
NPN compatible	No-voltage contact, two-wire sensors with DC output, NPN output type	3 to 6 mA	0 VDC to supply voltage	Normal-speed 19.2 ms	± common	16	B7A-T6B1
NPN compatible	No-voltage contact, two-wire sensors with DC output, NPN output type	3 to 6 mA	0 VDC to supply voltage	High-speed 3 ms	- common	16	B7A-T6C1
NPN compatible	No-voltage contact, two-wire sensors with DC output, NPN output type	3 to 6 mA	0 VDC to supply voltage	High-speed 3 ms	± common	16	B7A-T6A6
PNP compatible	No-voltage contact, two-wire sensors with DC output, NPN output type	3 to 6 mA	0 VDC to supply voltage	High-speed 3 ms	± common	16	B7A-T6B6
PNP compatible	No-voltage contact, two-wire sensors with DC output, NPN output type	3 to 6 mA	0 VDC to supply voltage	High-speed 3 ms	± common	16	B7A-T6C6

**P7TF Input Block Base without Modules**

Internal circuit	Points	Part number
NPN, negative common	16	P7TF-IS16-DC24V

Modules are available with 24 VDC, 5–24 VDC, 100–120 VAC, 200–240 VAC, and 100–240 VAC rated input voltages.

**G7T, and G3TA Relay and SSR Input Modules**

These relay and SSR modules are for use with G7TC and P7TF Input Blocks.

Name	Input voltage	Internal circuit	Part number
Input relay	100/120 VAC	NO	G7T-1122S-AC100/110V
Input relay	200/240 VAC	NO	G7T-1122S-AC200/220V
Input relay	12 VDC	NO	G7T-1122S-DC12V
Input relay	24 VDC	NO	G7T-1122S-DC24V
Input SSR	100 to 240 VAC	NO	G3TA-IAZR02S-AC100/240V
Input SSR	5 to 24 VDC	NO	G3TA-IDZR02S-DC5-24V

**G7TC Input Blocks with Modules**

Power supply	Input voltage	Internal circuit	Points	Part number
24 VDC*	100/120 VAC	NPN, negative common	16	G7TC-IA16-AC100/110V
24 VDC*	200/240 VAC	NPN, negative common	16	G7TC-IA16-AC200/220V
24 VDC*	24 VDC	NPN, negative common	16	G7TC-ID16-DC24V

\*Using G71 Remote Interface

## Input Connectors, Output Blocks

### B7A Input Connectors

Input configuration	Input voltage	Input current range	Input voltage range	I/O delay	Pts	Part number
NPN compatible	No-voltage contact, three wire NPN	0.6 mA to 1.5 mA	0 VDC to supply voltage	Normal-speed 19.2 ms	16	B7A-T6E3
NPN compatible	No-voltage contact, three wire NPN	0.6 mA to 1.5 mA	0 VDC to supply voltage	High-speed 3 ms	16	B7A-T6E8
NPN compatible	No-voltage contact, three wire NPN	0.6 mA to 1.5 mA	0 VDC to supply voltage	Normal-speed 19.2 ms	32	B7A-T3E3
NPN compatible	No-voltage contact, three wire NPN	0.6 mA to 1.5 mA	0 VDC to supply voltage	High-speed 3 ms	32	B7A-T3E8

### B7A Output Blocks

Output configuration	Rated load voltage	Rated load current	I/O delay	Common	Error processing	Pts	Part number
NPN open collector	5 to 24 VDC	100 mA max./point	Normal-speed 19.2 ms	+common	Hold	16	B7A-R6B11
NPN open collector	5 to 24 VDC	100 mA max./point	Normal-speed 19.2 ms	+common	Load OFF	16	B7A-R6B31
NPN open collector	5 to 24 VDC	100 mA max./point	High-speed 3 ms	+common	Hold	16	B7A-R6B16
NPN open collector	5 to 24 VDC	100 mA max./point	High-speed 3 ms	+common	Load OFF	16	B7A-R6B36
PNP open collector	5 to 24 VDC	100 mA max./point	Normal-speed 19.2 ms	- common	Hold	16	B7A-R6F11
PNP open collector	5 to 24 VDC	100 mA max./point	Normal-speed 19.2 ms	- common	Load OFF	16	B7A-R6F31
PNP open collector	5 to 24 VDC	100 mA max./point	High-speed 3 ms	- common	Hold	16	B7A-R6F16
PNP open collector	5 to 24 VDC	100 mA max./point	High-speed 3 ms	- common	Load OFF	16	B7A-R6F36
NPN open collector	5 to 24 VDC	500 mA max./point	Normal-speed 19.2 ms	+ common	Hold	16	B7A-R6C11
NPN open collector	5 to 24 VDC	500 mA max./point	Normal-speed 19.2 ms	+ common	Load OFF	16	B7A-R6C31
NPN open collector	5 to 24 VDC	500 mA max./point	High-speed 3 ms	+ common	Hold	16	B7A-R6C16
NPN open collector	5 to 24 VDC	500 mA max./point	High-speed 3 ms	+ common	Load OFF	16	B7A-R6C36
PNP open collector	5 to 24 VDC	500 mA max./point	Normal-speed 19.2 ms	- common	Hold	16	B7A-R6G11
PNP open collector	5 to 24 VDC	500 mA max./point	Normal-speed 19.2 ms	- common	Load OFF	16	B7A-R6G31
PNP open collector	5 to 24 VDC	500 mA max./point	High-speed 3 ms	- common	Hold	16	B7A-R6G16
PNP open collector	5 to 24 VDC	500 mA max./point	High-speed 3 ms	- common	Load OFF	16	B7A-R6G36

**P7TF Output Block Base without Modules**

Internal circuit	Points	Part number
NPN, positive common	8	P7TF-OS08
PNP, negative common	8	P7TF-OS08-1
NPN, positive common	16	P7TF-OS16
PNP, negative common	16	P7TF-OS16-1

Modules are available with 12 VDC, and 24 VDC rated input voltages.

**G7T, and G3TA Relay and SSR Output Modules**

These relay and SSR modules are for use with G7TC and P7TF Output Blocks.

Description	Input voltage	Switching capacity	Internal circuit	Part number
Output Relay	12 VDC	5 A, 125 VDC/250 VAC	NC	G7T-1012S DC12V
Output Relay	24 VDC	5 A, 125 VDC/250 VAC	NC	G7T-1012S DC24V
Output Relay	12 VDC	5 A, 125 VDC/250 VAC	NO	G7T-1112S-DC12V
Output Relay	24 VDC	5 A, 125 VDC/250 VAC	NO	G7T-1112S-DC24V
Output SSR, triac	12 VDC	2 A, 75 to 250 VAC	NO	G3TA-OA202SZ-DC12V
Output SSR, triac	24 VDC	2 A, 75 to 250 VAC	NO	G3TA-OA202SZ-DC24V
Output SSR, transistor	24 VDC	2 A, 4 to 60 VDC	NO	G3TA-ODX02S-DC24V
Output SSR, transistor	24 VDC	1 A, 40 to 200 VAC	NO	G3TA-OD201S-DC24V

**G77-S Short-circuit Output Module**

This module is for use with G7TC and P7TF Output Blocks.

Description	Part number
Short-circuiting output module for direct connection of load to output block	G77-S

**G7TC Output Blocks with Modules**

Coil voltage	Switching capacity	Internal circuit	Points	Part number
12 VDC	5 A, 125 VDC/250 VAC	NPN, positive common	8	G7TC-OC08-DC12V
24 VDC	5 A, 125 VDC/250 VAC	NPN, positive common	8	G7TC-OC08-DC24V
12 VDC	5 A, 125 VDC/250 VAC	NPN, positive common	16	G7TC-OC16-DC12V
24 VDC	5 A, 125 VDC/250 VAC	NPN, positive common	16	G7TC-OC16-DC24V
24 VDC	5 A, 125 VDC/250 VAC	PNP, negative common	16	G7TC-OC16-1-DC24V

### Connecting Cables, Shorting Bar

Name	Description	Part number
Spade Connector I/O Block Cable	50 cm (1.6 ft.)	G79-Y050C
	1 m (3.3 ft.)	G79-Y100C
	1.5 m (4.9 ft.)	G79-Y150C
	2 m (6.6 ft.)	G79-Y200C
	5 m (16.5 ft.)	G79-Y500C
Quick-connect I/O Block Cable (24 pins)	For 1 Block, 1 m (3.3 ft.)	G79-100C
	For 1 Block, 1.5 m (4.9 ft.)	G79-150C
	For 1 Block, 2 m (6.6 ft.)	G79-200C
	For 1 Block, 2 m (6.6 ft.)	G79-300C
	For 1 Block, 5 m (16.5 ft.)	G79-500C
Quick-connect Input Block Cable (40 pins)	For 2 Blocks, 1 m (3.3 ft.)	G79-I100C-75
	For 2 Blocks, 1.5 m (3.3 ft.)	G79-I150C-125
	For 2 Blocks, 2 m (6.6 ft.)	G79-I200C-175
	For 2 Blocks, 3 m (6.6 ft.)	G79-I300C-275
	For 2 Blocks, 5 m (16.5 ft.)	G79-I500C-475
Quick-connect Output Block Cable (40 pins)	For 2 Blocks, 1 m (3.3 ft.)	G79-O100C-75
	For 2 Blocks, 1.5 m (3.3 ft.)	G79-O150C-125
	For 2 Blocks, 2 m (6.6 ft.)	G79-O200C-175
	For 2 Blocks, 3 m (6.6 ft.)	G79-O300C-275
	For 2 Blocks, 5 m (16.5 ft.)	G79-O500C-475
Shorting Bar	Short circuits 2 to 4 adjacent terminals	G78-04

### Panel-mount, Stand-alone Power Supplies

Output	Input	Part number
5 VDC, 1.5 A	85 to 132 VAC	S82K-0705
5 VDC, 2.5 A	85 to 132 VAC	S82K-0105
12 VDC, 0.6 A	85 to 132 VAC	S82K-0712
12 VDC, 1.2 A	85 to 132 VAC	S82K-0112
12 VDC, 2.5 A	85 to 132 VAC	S82K-0312
24 VDC, 0.3 A	85 to 132 VAC	S82K-0724
24 VDC, 0.6 A	85 to 132 VAC	S82K-0124
24 VDC, 1.3 A	85 to 132 VAC	S82K-0324
24 VDC, 2.1 A	85 to 132 VAC	S82K-0524
24 VDC, 4.6 A	85 to 132/170 to 264 VAC	S82H-3024
24 VDC, 7 A	85 to 132/170 to 264 VAC	S82G-1524

Description	Part number
<b>SYSMAC NET</b>	
PLC module (rack-mount)	C200HS-SNT32
Power supply adapter for 1 SYSMAC NET module (rack-mount PLC module) for 2 SYSMAC NET modules	C200H-APS01 C200H-APS02
Cable to connect for APS01 Power supply adapter for APS02	C200H-CN001 C200H-CN002
SYSMAC NET LINK for 1 SYSMAC NET module Power supply adapter for 2 SYSMAC NET modules	C200H-CE001 C200H-CE002
Line server, 24 VDC	S3200-LSU03-01E
IBM PC/AT interface board	S3200-NSB11-E
RS-232C interface, 24 VDC	S3200-NSUA1-00E
Bridge, DC-powered	S3200-NSUG4-00E
VME interface board	3G8B3-CL001
FIT interface board	FIT10-IF401
<b>SYSMAC LINK</b>	
PLC module (rack-mount), fiber-optic; bus connector required	C200HS-SLK12
PLC module (rack-mount), coaxial; bus connector required	C200HS-SLK22
SYSMAC NET LINK for 1 SYSMAC LINK module Power supply adapter for 2 SYSMAC LINK modules	C200H-CE001 C200H-CE002
75-ohm terminator for coaxial module	C1000H-TER01
Connector, F-type for coaxial module	C1000H-CE001
Connector cover for coaxial module	C1000H-COV01
<b>SYSMAC WAY Host Link</b>	
PLC module (rack-mount), fiber optic APF, PCF, HPCF	C200H-LK101-P
PLC module (rack-mount), RS-422	C200H-LK202
PLC module (rack-mount), RS-232C	C200H-LK201
PC Link PLC module (rack-mount), RS-485 (twisted pair)	C200H-LK401

**Link Adapters**

Cable type	Part number
<b>PC Link SYSMAC WAY Host Link</b>	
3 RS-422	3G2A9-AL001
<b>SYSMAC BUS Fiber-optic Remote I/O, PC Link, SYSMAC WAY Host Link</b>	
3 fiber-optic: PCF, HPCF	3G2A9-AL002-E
3 fiber-optic: APF, PCF, HPCF	3G2A9-AL002-PE
1 fiber-optic: PCF, HPCF, 1 RS-232C, 1 RS-422	3G2A9-AL004-E
1 fiber-optic: APF, PCF, HPCF, 1 RS-232C, 1 RS-422	3G2A9-AL004-PE
2 fiber-optic: PCF, HPCF to AGF	3G2A9-AL005-E
2 fiber-optic: APF, PCF, HPCF to AGF	3G2A9-AL005-PE
3 fiber-optic: AGF trunk, PCF, HPCF branches	3G2A9-AL006-E
3 fiber-optic: AGF trunk, APF, PCF, HPCF branches	3G2A9-AL006-PE
<b>SYSMAC BUS Wired Remote I/O</b>	
RS-485 to fiber-optic: APF, PCF, HPCF	B500-AL007-P
<b>SYSMAC NET</b>	
3 fiber-optic: HPCF	B700-AL001

6



Description	Part number
<b>SYSMATE LSS</b>	
Ladder diagram programming software for AT-compatible computers (3.5" and 5.25" disks), all C-Series PLCs: Single user license	C500-Y9LS11-EV3
Ladder diagram programming software for AT-compatible computers (3.5" and 5.25" disks), all C-Series PLCs: Five user license	C500-Y9LS15-EV3
Ladder diagram programming software for AT-compatible computers (3.5" and 5.25" disks), all C-Series PLCs: Ten user license	C500-Y9LS10-EV3
<b>Programming Cable</b>	
Built-In Host Link Port to computer (9-pin RS-232)	C200HS-CN220-EU
Built-In Host Link Port to computer (25-pin RS-232)	C200HS-CN229-EU
C200H-LK201 to computer (9-pin RS-232)	C500-CN221-EU
C200H-LK201 to computer (25-pin RS-232)	C500-CN222-EU
<b>Graphic Programming Console</b>	
All C-Series PLCs, requires memory pack; 120 VAC	3G2C5-GPC03-E
All C-Series PLCs, requires memory pack; 240 VAC	3G2C5-GPC04-E
Carrying case, nylon	3G2C5-CS001
Memory pack for C20, P-type, C120, C500	C500-MP303-EV2
Memory pack for K-type, Block-style H-type, C200H, C1000H, C2000H	3G2C5-MP304-EV3
Peripheral interface unit to PLC CPU	C200H IP006
Peripheral interface cable, 2 m	3G2A2-CN221
Peripheral interface cable, 10 m	3G2A5-CN131
CRT interface	3G2C5-GDI01
Replacement key sheet for GPC	Key sheet of 3G2C5-GPC03
<b>Factory Intelligent Terminal</b>	
Set includes FIT, system disks, and FIT MS-DOS disk	FIT10-SET11-E
MS-DOS floppy disk	FIT10-MF001-E
System floppy disk	FIT10-MF101-EV4
Peripheral interface to PLC CPU	C200H IP006
Peripheral interface cable, 2 m	3G2A2-CN221
Peripheral interface cable, 10 m	3G2A5-CN131
SYSMAC NET interface board for FIT	FIT10-IF401
<b>ASCII/BASIC Module Utility Software</b>	
For AT-compatible computers; enables program development, downloading, uploading, etc.	SYSMATE-ASC91-V1
Programming Cable C200H-ASC02 to computer (9-pin RS-232)	C200H-CN229-EU
Programming Cable C200H-ASC02 to computer (25-pin RS-232)	C200H-CN220-EU
<b>Programming Console</b>	
Console (CPU-mount) with back-lit LCD	3G2A5-PRO13-E
Extension cable for PRO13-E, 1 m (3.28 ft.)	3G2C7-CN122
Console (Desk-top, panel-mount) with back-lit LCD, requires cable and interface	C200H-PRO27-E
PRO27 interface	C500-AP003
PRO27 extension cable, 2 m	C200H-CN222
PRO27 extension cable, 4 m	C200H-CN422
PRO27 panel-mounting bracket	C200H-ATT01
<b>PROM Writer</b>	
All C-Series PLCs	C500-PRW06
<b>Printer Interface</b>	
All C-Series PLCs, requires memory pack	3G2A5-PRT01-E
Memory pack, C500	C500-MP102-EV3
Memory pack, C1000H, C2000H	3G2A5-MP103-EV3
Printer cable, RS-232C	SCY-CN201
<b>Cassette Interface</b>	
All C-series PLCs	3G2A5-CMT01-E

Name	Description	Part number
<b>All Plastic Fiber-optic (APF) Cable</b>		
Fiber-optic cable	20 m (65.6 ft.), without connectors	B500-PF212
Fiber-optic connectors	Brown, for cable 0 to 10 m (0 to 32.8 ft.) long (set of 2)	3G5A2-CO001
	Black, for cable 8 to 20 m (0 to 65.6 ft.) long (set of 2)	3G5A2-CO002
<b>Hard Plastic-Clad Fiber-optic (HPCF) Cable</b>		
Fiber-optic cable	50 m (164 ft.), without connectors	FCS-HCR-LB-501
	100 m (328 ft.), without connectors	FCS-HCR-LB-102
	500 m (0.31 mile), without connectors	FCS-HCR-LB-502
	1 km (0.62 mile), without connectors	FCS-HCR-LB-103
	Zipcord style, orange, 50 m (164 ft.), without connectors	FCS-HCR-CO-501
Fiber-optic connectors	SYSMAC BUS or SYSMAC WAY only	S3200-COCH82
	SYSMAC BUS/2 (all PLCs), SYSMAC LINK (other than C200H)	S3200-COCF2011
	SYSMAC NET (other than C200H)	S3200-COCH62M
	SYSMAC NET, LINK (C200H only)	S3200-COCF2511
	SYSMAC NET in-line male	S3200-COCF62M
	SYSMAC NET in-line female	S3200-COCF62F
Termination kit	For HPCF cable	FCS-CAK6230-US
<b>Plastic-Clad Fiber-optic (PCF) Cable</b>		
Indoor fiber-optic cable	10 cm (0.32 ft.), with connectors	3G5A2-OF011
	1 m (3.2 ft.), with connectors	3G5A2-OF101
	2 m (6.56 ft.), with connectors	3G5A2-OF201
	3 m (9.8 ft.), with connectors	3G5A2-OF301
	5 m (16.4 ft.), with connectors	3G5A2-OF501
	10 m (32.8 ft.), with connectors	3G5A2-OF111
	20 m (65.6 ft.), with connectors	3G5A2-OF211
	30 m (98 ft.), with connectors	3G5A2-OF311
	50 m (164 ft.), with connectors	3G5A2-OF511
Indoor/Outdoor fiber-optic cable	100 m (328 ft.), with connectors	3G5A2-OF002-100M
	200 m (656 ft.), with connectors	3G5A2-OF002-200M
	400 m (0.25 mile), with connectors	3G5A2-OF002-400M
	800 m (0.5 mile), with connectors	3G5A2-OF002-800M

## PLC Installation, Operation

Title	Subtitle	Cat. No.
C200H PLCs	Installation Guide	W111
	Operation Manual	W130
C200HS PLCs	Installation Guide	W236
	Operation Manual	W235

## Special I/O Modules

Title	Subtitle	Cat. No.
ASC02 ASCII/BASIC Module	Operation Manual	W165
Analog I/O Modules	Operation Guide	W127
8-pt Analog Input Module	Operation Manual	W229
Temperature Sensor Input Module	Operation Guide	W124
Temperature Controller Module	Operation Manual	W225
Heat/Cool Temperature Controller Module	Operation Manual	W240
PID Process Controller Module	Operation Manual	W241
Cam Positioner Module	Operation Manual	W224
CT001-V1, CT002 High-speed Counter Modules	Operation Manual	W141
NC111 Position Control Module	Operation Manual	W137
NC112 Position Control Module	Operation Manual	W128
NC221 Position Control Module	Operation Manual	W166
RF ID Interface Modules	Operation Guide	W153
OV001 Voice Output Module	Operation Manual	W172

## Peripheral Devices

Software manuals (such as for SYSMATE LSS and Programmable Terminal Support Software) are available only with a Software or site-license purchase.

Title	Subtitle	Cat. No.
FIT	Operation Manual	W150
Graphic Programming Console	Operation Manual	W084
PROM Writer	Operation Guide	W155
Printer Interface	Operation Guide	W107
Cassette Interface	User's Manual	W064

**Communication Systems**

Title	Subtitle	Cat. No.
SYSMAC NET	System Manual	W178
SYSMAC NET Line Server	Installation Guide	W161
SYSMAC NET Module	Operation Manual	W114
SYSMAC NET RS-232C Interface (Network Service Unit)	Operation Manual	W160
SYSMAC NET IBM AT Interface Board	Operation Manual	W161
SYSMAC NET Fiber-optic Cable	Installation Guide	W156
SYSMAC NET Bridge	Installation Guide	W159
C-series SYSMAC LINK	System Manual	W174
CV-series SYSMAC LINK	System Manual	W212
CV-series PLCs Host LINK	System Manual	W143
SYSMAC BUS Fiber-optic Remote I/O	System Manual	W136
SYSMAC BUS Wired Remote I/O	System Manual	W120
C-, CV-series Fiber-optic Cable	Installation Guide	W152
Link Adapters	Installation Guide	W123

**Reference**

Title	Subtitle	Cat. No.
Programming instructions, programming console operations	Reference Manual	W184

# 14 Instruction Set

Overview .....	178
Basic Instructions .....	179
Data Comparison Instructions .....	182
Data Transfer Instructions .....	184
Data Conversion Instructions .....	187
BCD Math Instructions .....	190
Binary Math Instructions .....	192
Data Shift Instructions .....	194
Logic Instructions .....	196
Subroutine, Program Step Instructions .....	197
Special Instructions .....	198
Network Instructions .....	203

### Overview

The C200HS instruction set offers easy-to-program interrupts that allow high-speed response outside the normal scan cycle. There are many step-saving instructions, such as a macro similar to ones that are programmed into computers.

Many application-specific instructions are available to simplify position and speed control, process control, and input/output to operator displays. There are 52 “expansion instructions” that can be used to customize the instruction set to suit your application needs. Up to 18 of these expansion instructions can be substituted for other instructions that may not be needed in a program.

### To Input PLC Instructions

A PLC instruction is input either by pressing the corresponding Programming Console key(s) (e.g., LD, AND, OR, NOT) or by using function codes. To input an instruction with its function code, press FUN, the function code, and the WRITE. Refer to the pages listed programming and instruction details.

### Differentiated Instructions

An instruction marked with @ can be used as a differentiated instruction that will be executed only once each time the instruction executing condition is turned ON.

### Using Expansion Instructions







All shaded instructions are expansion instructions. Those marked with an asterisk do not have default function numbers. Before using any expansion instruction (marked with an asterisk and within shaded boxes), it is necessary to set the function number for the expansion instruction. The following 18 function codes can be replaced with expansion instructions using LSS or the programming console: 17, 18, 19, 47, 48, 60, 61, 62, 63, 64, 65, 66, 67, 68, 69, 87, 88, and 89.

Mnemonic	Function Code	Mnemonic	Function Code	Mnemonic	Function Code	Mnemonic	Function Code
ASFT	17	BCNT	67	DBSL	—	NEGL	—
SCAN	18	BCMP	68	DSW	—	PID	—
MCMP	19	APR	69	FCS	—	RXD	—
LMSG	47	TTIM	87	FPD	—	SBBL	—
TERM	48	ZCP	88	HEX	—	SCL	—
CMPL	60	INT	89	HKY	—	SRCH	—
MPRF	61	7SEG	—	MAX	—	SUM	—
XFRB	62	ADBL	—	MBS	—	TKY	—
LINE	63	AVG	—	MBSL	—	TXD	—
COLM	64	CPS	—	MIN	—	XDMR	—
SEC	65	CPSL	—	MTR	—	ZCPL	—
HMS	66	DBS	—	NEG	—		—

Name Mnemonic	Symbol	Function	Operands	CPU
<b>Load</b> LD		Used to start instruction line with status of designated bit. Used to define a logic block for use with AND LD and OR LD.	<b>B:</b> IR SR HR AR TC LR TR	All models
<b>Load NOT</b> LD NOT		Used to start instruction line with inverse of designated bit.	<b>B:</b> IR SR HR AR TC LR	All models
<b>AND</b> AND		Logically ANDs status of designated bit with execution condition.	<b>B:</b> IR SR HR AR TC LR	All models
<b>AND NOT</b> AND NOT		Logically ANDs inverse of designated bit with execution condition.	<b>B:</b> IR SR HR AR TC LR	All models
<b>OR</b> OR		Logically ORs status of designated bit with execution condition.	<b>B:</b> IR SR HR AR TC LR	All models
<b>OR NOT</b> OR NOT		Logically ORs inverse of designated bit with execution condition.	<b>B:</b> IR SR HR AR TC LR	All models
<b>AND Load</b> AND LD		Logically ANDs results of preceding blocks.	None	All models
<b>OR Load</b> OR LD		Logically ORs results of preceding blocks.	None	All models
<b>Output</b> OUT		Turns ON B for ON execution condition; turns OFF B for OFF execution condition.	<b>B:</b> IR SR HR AR LR TR	All models

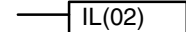
Name Mnemonic	Symbol	Function	Operands	CPU	
<b>RESET</b> RESET		Turns B OFF for ON execution condition and remains OFF when execution condition returns to OFF	<b>B:</b> IR SR AR HR LR	HS-CPU01 HS-CPU03	
<b>SET</b> SET		Turns B OFF for ON execution condition and remains OFF when execution condition returns to OFF	<b>B:</b> IR SR AR HR LR	HS-CPU01 HS-CPU03	
<b>Output NOT</b> OUT NOT		Turns B OFF for ON execution condition; turns B ON for OFF execution condition (i.e., inverts operation).	<b>B:</b> IR SR HR AR LR	All models	
<b>No Operation</b> NOP (00)	None	Nothing is executed and program moves to next instruction.	None	All models	
<b>End</b> END(01)		Required at the end of the program.	None	All models	
<b>Latching Relay</b> KEEP(11)		Defines a bit (B) as a latch controlled by set (S) and reset (R) inputs.	<b>B:</b> IR HR AR LR	All models	
<b>Timer</b> TIM		ON-delay (decrementing) timer operation. Set value: 999.9 s; accuracy: +0/-0.1 s. Same TC bit cannot be assigned to more than one timer/counter. The TC bit is input as a constant.	<b>N:</b> TC	<b>SV:</b> IR HR AR DM LR #	All models
<b>High-speed Timer</b> TIMH(15)		A high-speed, ON-delay (decrementing) timer. SV: 0.01 to 99.99 s; accuracy: +0/-0.1 s. Must not be assigned the same TC bit as another timer or counter. The TC bit is input as a constant.	<b>N:</b> TC	<b>SV:</b> IR SR HR AR DM LR #	All models
<b>Counter</b> CNT		A decrementing counter. SV: 0 to 9999; CP: count pulse; R: reset input. The TC bit is input as a constant.	<b>N:</b> TC	<b>SV:</b> IR HR AR DM LR #	All models
<b>Reversible Counter</b> CNTR (12)		Increases or decreases PV by one whenever the increment input (II) or decrement input (DI) signals, respectively, go from OFF to ON. SV: 0 to 9999; R: reset input. Must not access the same TC bit as another timer/counter.	<b>N:</b> TC	<b>SV:</b> IR SR HR AR DM LR #	All models

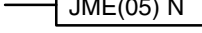

Name Mnemonic	Symbol	Function	Operands	CPU
<b>Differentiate Up</b> DIFU(13) <b>Differentiate Down</b> DIFD(14)	 DIFU(13) B  DIFD(14) B	DIFU turns ON the designated bit (B) for one scan on the rising edge of the input signal; DIFD turns ON the bit for one scan on the trailing edge.	<b>B:</b> IR HR AR LR	All models
<b>Interlock</b> IL(02) <b>Interlock Clear</b> ILC(03)	 IL(02)  ILC(03)	If interlock condition is OFF, all outputs are turned OFF and all timer PVs reset between this IL(02) and the next ILC(03). Other instructions are treated as NOP; counter PVs are maintained.	None	All models
<b>Jump</b> JMP(04) <b>Jump End</b> JME(05)	 JMP(04) N  JME(05) N	If jump condition is OFF, all instructions between JMP(04) and the corresponding JME(05) are ignored. Corresponding JME is one of same number; 01 through 99 only usable once per program (direct jumps); 00 may be used as many times as necessary, but instructions between JMP 00 and JME 00 treated as NOP, increasing scan time compared to other jumps.	<b>N:</b> 00 to 99	All models
<b>Totalizing Timer</b> TTIM (87)		Incrementing timer that increments PV every 0.1 s to time between 0.1s to 999.9 s. Accuracy is +0.0/-0.1 sec. Will time as long as execution condition is ON until it reaches SV or until RB turns ON to reset timer.	<b>N:</b> TC <b>SV:</b> (word, BCD) IR AR DM HR LR <b>RB:</b> IR SR AR HR LR	HS-CPU01 HS-CPU03

Name Mnemonic	Symbol	Function	Operands	CPU
<b>Multi-word Compare</b> (@)MCMP(19)		Compares the data within a block of 16 words of 4-digit hexadecimal data (S <sub>1</sub> to S <sub>1</sub> +15) with that in another block of 16 words (S <sub>2</sub> to S <sub>2</sub> +15) on a word-by-word basis. If the words are not in agreement, the bit corresponding to unmatched words turns ON in the result word, D. Bits corresponding to words that are equal are turned OFF.	<b>S1:</b> IR SR HR AR LR TC DM  <b>S2:</b> IR SR HR AR LR TC DM  <b>D:</b> IR SR HR AR LR TC DM	CPU21 CPU23 CPU31 HS-CPU's
<b>Compare</b> (@)CMP(20)		Compares two sets of four-digit hexadecimal data (Cp1 and Cp2) and outputs result to GR, EQ, and LE. Cp1 > Cp2 → GR Cp1 = Cp2 → EQ Cp1 < Cp2 → LE	<b>Cp1/Cp2:</b> IR SR HR AR TC DM LR #	All models
<b>Double Compare</b> CMPL(60)		Compares the 8-digit hexadecimal values in words S <sub>1</sub> +1 and S <sub>1</sub> with the values in S <sub>2</sub> +1 and S <sub>2</sub> , and indicates the result using the Greater Than, Less Than, and Equal Flags in the AR area. S <sub>1</sub> +1 and S <sub>2</sub> +1 are regarded as the most significant data in each pair of words.	<b>S1/S2</b> IR SR HR AR LR TC DM	CPU21 CPU23 CPU31 HS-CPU's
<b>Block Compare</b> BCMP(68)		Compares 1-word binary value (S) with 16 ranges in comparison table (CB: starting word of comparison block). If value falls within any ranges, corresponding bits of result word (R) will set. The comparison block must all be in the same data area. Lower limit Upper limit  Lower limit ≤ S ≤ Upper limit → 1	<b>S:</b> IR SR HR AR TC DM LR #  <b>CB:</b> IR SR HR TC DM LR  <b>R:</b> IR HR AR TC DM LR	All models HS-CPU's
<b>Table Compare</b> (@)TCMP(85)		Compares four-digit hexadecimal value (S) with values in table consisting of 16 words (TB: First word of comparison table). If value equals any values, corresponding bits of result word (R) are set. The entire table must be in the same data area.  1:agreement 0:disagreement	<b>S:</b> IR SR HR AR TC DM LR #  <b>TB/R:</b> IR HR AR TC DM LR	All models

Name Mnemonic	Symbol	Function	Operands	CPU																															
<b>Area Range Compare (@)</b> ZCP (88)	<table border="1"> <tr><td>ZCP(88)</td></tr> <tr><td>CD</td></tr> <tr><td>LL</td></tr> <tr><td>UL</td></tr> </table>	ZCP(88)	CD	LL	UL	Compares a word to a range defined by Lower and Upper Limits and outputs the result to GR, EQ and LE flags.	<table border="1"> <tr><td><b>CD:</b></td><td><b>LL:</b></td><td><b>UL:</b></td></tr> <tr><td>IR</td><td>IR</td><td>IR</td></tr> <tr><td>SR</td><td>SR</td><td>SR</td></tr> <tr><td>HR</td><td>HR</td><td>HR</td></tr> <tr><td>AR</td><td>AR</td><td>AR</td></tr> <tr><td>TC</td><td>TC</td><td>TC</td></tr> <tr><td>DM</td><td>DM</td><td>DM</td></tr> <tr><td>LR</td><td>LR</td><td>LR</td></tr> <tr><td>#</td><td>#</td><td>#</td></tr> </table>	<b>CD:</b>	<b>LL:</b>	<b>UL:</b>	IR	IR	IR	SR	SR	SR	HR	HR	HR	AR	AR	AR	TC	TC	TC	DM	DM	DM	LR	LR	LR	#	#	#	HS-CPU's
ZCP(88)																																			
CD																																			
LL																																			
UL																																			
<b>CD:</b>	<b>LL:</b>	<b>UL:</b>																																	
IR	IR	IR																																	
SR	SR	SR																																	
HR	HR	HR																																	
AR	AR	AR																																	
TC	TC	TC																																	
DM	DM	DM																																	
LR	LR	LR																																	
#	#	#																																	
<b>Signed binary compare</b> CPS (*)	<table border="1"> <tr><td>CPS(-)</td></tr> <tr><td>Cp1</td></tr> <tr><td>Cp2</td></tr> </table>	CPS(-)	Cp1	Cp2	Compares two 16-bit (4-digit) signed binary values and outputs the result to GR, EQ and LE flags.	<table border="1"> <tr><td><b>Cp1:</b></td><td><b>Cp2:</b></td></tr> <tr><td>IR</td><td>IR</td></tr> <tr><td>SR</td><td>SR</td></tr> <tr><td>HR</td><td>HR</td></tr> <tr><td>AR</td><td>AR</td></tr> <tr><td>TC</td><td>TC</td></tr> <tr><td>DM</td><td>DM</td></tr> <tr><td>LR</td><td>LR</td></tr> <tr><td>#</td><td>#</td></tr> </table>	<b>Cp1:</b>	<b>Cp2:</b>	IR	IR	SR	SR	HR	HR	AR	AR	TC	TC	DM	DM	LR	LR	#	#	HS-CPU's										
CPS(-)																																			
Cp1																																			
Cp2																																			
<b>Cp1:</b>	<b>Cp2:</b>																																		
IR	IR																																		
SR	SR																																		
HR	HR																																		
AR	AR																																		
TC	TC																																		
DM	DM																																		
LR	LR																																		
#	#																																		
<b>Double signed binary compare</b> CPSL (*)	<table border="1"> <tr><td>CPSL(-)</td></tr> <tr><td>Cp1</td></tr> <tr><td>Cp2</td></tr> </table>	CPSL(-)	Cp1	Cp2	Compares two 32-bit (8-DIGIT) signed binary values and outputs the result to GR, EQ and LE flags.	<table border="1"> <tr><td><b>Cp1:</b></td><td><b>Cp2:</b></td></tr> <tr><td>IR</td><td>IR</td></tr> <tr><td>SR</td><td>SR</td></tr> <tr><td>AR</td><td>AR</td></tr> <tr><td>DM</td><td>DM</td></tr> <tr><td>HR</td><td>HR</td></tr> <tr><td>TC</td><td>TC</td></tr> <tr><td>LR</td><td>LR</td></tr> </table>	<b>Cp1:</b>	<b>Cp2:</b>	IR	IR	SR	SR	AR	AR	DM	DM	HR	HR	TC	TC	LR	LR	HS-CPU's												
CPSL(-)																																			
Cp1																																			
Cp2																																			
<b>Cp1:</b>	<b>Cp2:</b>																																		
IR	IR																																		
SR	SR																																		
AR	AR																																		
DM	DM																																		
HR	HR																																		
TC	TC																																		
LR	LR																																		
<b>Double area range compare</b> ZCPL (*)	<table border="1"> <tr><td>ZCPL(-)</td></tr> <tr><td>CD</td></tr> <tr><td>LL</td></tr> <tr><td>UL</td></tr> </table>	ZCPL(-)	CD	LL	UL	Compares an 8-digit value to a range and outputs the result to GR, EQ and LE flags.	<table border="1"> <tr><td><b>CD:</b></td><td><b>LL:</b></td><td><b>UL:</b></td></tr> <tr><td>IR</td><td>IR</td><td>IR</td></tr> <tr><td>SR</td><td>SR</td><td>SR</td></tr> <tr><td>HR</td><td>HR</td><td>HR</td></tr> <tr><td>AR</td><td>AR</td><td>AR</td></tr> <tr><td>TC</td><td>TC</td><td>TC</td></tr> <tr><td>DM</td><td>DM</td><td>DM</td></tr> <tr><td>LR</td><td>LR</td><td>LR</td></tr> </table>	<b>CD:</b>	<b>LL:</b>	<b>UL:</b>	IR	IR	IR	SR	SR	SR	HR	HR	HR	AR	AR	AR	TC	TC	TC	DM	DM	DM	LR	LR	LR	HS-CPU's			
ZCPL(-)																																			
CD																																			
LL																																			
UL																																			
<b>CD:</b>	<b>LL:</b>	<b>UL:</b>																																	
IR	IR	IR																																	
SR	SR	SR																																	
HR	HR	HR																																	
AR	AR	AR																																	
TC	TC	TC																																	
DM	DM	DM																																	
LR	LR	LR																																	

Name Mnemonic	Symbol	Function	Operands	CPU
<b>Move</b> (@)MOV(21)		Transfers source data (S) (word or four-digit constant) to destination word (D).	<b>S:</b> IR SR HR AR TC DM LR # <b>D:</b> IR HR AR DM LR	All models
<b>Move NOT</b> (@)MVN(22)		Inverts source data (S) (word or four-digit constant) and then transfers it to destination word (D).	<b>S:</b> IR SR HR AR TC DM LR # <b>D:</b> IR HR AR DM LR	All models
<b>Column-to-Word</b> (@)CTW(63)		Fetches data from the same numbered bit (C) in 16 consecutive words (where S is the address of the first source word), and creates a 4-digit word by consecutively placing the data in the bits of the destination word, D. The bit from word S is placed into bit 00 of D, the bit from word S+1 is placed into bit 01, etc.	<b>S:</b> IR SR HR AR LR TC DM <b>C:</b> IR SR HR AR LR TC DM # <b>D:</b> IR SR HR AR LR TC DM	CPU21 CPU23 CPU31
<b>Column-to-Line</b> (@)LINE(63)				HS-CPU's
<b>Word-to-Column</b> (@)WTC(64)		Places bit data from the source word (S), consecutively into the same numbered bits of the 16 consecutive destination words (where D is the address of the first destination word). Bit 00 from word S is placed into bit C of word D, bit 01 from word S is placed into bit C of word D+1, etc.	<b>S:</b> IR SR HR AR LR TC DM <b>D:</b> IR SR HR AR LR TC DM <b>C:</b> IR SR HR AR LR TC DM #	CPU21 CPU23 CPU31
<b>Line-to-Column</b> (@)COLM(64)				HS-CPU's
<b>Block Set</b> (@)BSET(71)		Copies content of one word or constant (S) to several consecutive words (starting word (St) through ending word (E)). St and E must be in the same data area. 	<b>St/E:</b> IR HR AR TC DM LR <b>S:</b> IR SR HR AR TC DM LR #	All models

Name Mnemonic	Symbol	Function	Operands	CPU				
<b>Transfer Bits</b> (@)XFRB(62)	<table border="1"> <tr><td>XFER(62)</td></tr> <tr><td>C</td></tr> <tr><td>S</td></tr> <tr><td>D</td></tr> </table>	XFER(62)	C	S	D	Copies the status of up to 255 specified source bits to the specified destination bits.	<b>C:</b> IR SR AR DM TC HR LR #  <b>S:</b> IR SR AR DM HR LR  <b>D:</b> IR SR AR DM HR LR	HS-CPU's
XFER(62)								
C								
S								
D								
<b>Block Transfer</b> (@)XFER(70)	<table border="1"> <tr><td>XFER(70)</td></tr> <tr><td>N</td></tr> <tr><td>S</td></tr> <tr><td>D</td></tr> </table>	XFER(70)	N	S	D	Moves content of several consecutive source words (S: starting source word; N: number of transfer words) to consecutive destination words (D: starting destination word). All source words must be in the same data area, as must all destination words. Transfers can be within one or between two data areas, but the source words and destination word must not overlap.  	<b>N:</b> IR SR HR AR TC DM LR #  <b>S:</b> IR HR AR TC DM LR  <b>D:</b> IR SR HR AR TC DM LR #	All models
XFER(70)								
N								
S								
D								
<b>Single Word Distribute</b> (@)DIST(80)	<table border="1"> <tr><td>DIST(80)</td></tr> <tr><td>S</td></tr> <tr><td>DBs</td></tr> <tr><td>Of</td></tr> </table>	DIST(80)	S	DBs	Of	Moves one word of source data (S) to destination word whose address is given by destination base word (DBs) plus offset (Of).  	<b>S:</b> IR SR HR AR TC DM LR #  <b>DBs:</b> IR HR AR TC DM LR  <b>Of:</b> IR HR AR TC DM LR #	All models
DIST(80)								
S								
DBs								
Of								
<b>Data Collect</b> (@)COLL(81)	<table border="1"> <tr><td>COLL(81)</td></tr> <tr><td>SBs</td></tr> <tr><td>Of</td></tr> <tr><td>D</td></tr> </table>	COLL(81)	SBs	Of	D	Extracts data from source word and writes it to destination word (D). Source word is determined by adding offset (Of) to source base word (SBs).  	<b>SBs:</b> IR SR HR AR TC DM LR  <b>Of:</b> IR HR AR TC DM LR #  <b>D:</b> IR HR AR TC DM LR	All models
COLL(81)								
SBs								
Of								
D								
<b>Move Bit</b> (@)MOVB(82)	<table border="1"> <tr><td>MOVB(82)</td></tr> <tr><td>S</td></tr> <tr><td>Bi</td></tr> <tr><td>D</td></tr> </table>	MOVB(82)	S	Bi	D	Transfers designated bit of source word or constant (S) to designated bit of destination word (D). Rightmost two digits of bit designator (Bi) designate the source bit; leftmost two, the destination bit.  	<b>S:</b> IR SR HR AR DM LR #  <b>Bi:</b> IR HR AR TC DM LR #  <b>D:</b> IR HR AR DM LR	All models
MOVB(82)								
S								
Bi								
D								

Name Mnemonic	Symbol	Function	Operands	CPU							
<b>Move Digit</b> (@)MOVD(83)	<table border="1"> <tr><td>MOVD(83)</td></tr> <tr><td>S</td></tr> <tr><td>Di</td></tr> <tr><td>D</td></tr> </table>	MOVD(83)	S	Di	D	<p>Moves hexadecimal content of specified four-bit source digit(s) (S: source word) to specified destination digit(s) (D: destination word) for up to four digits. Source and destination digits specified in Digit Designator (Di) digits (rightmost digit: source digit; next digit to left: number of digits to be moved; next digit: destination digit).</p>	<table border="1"> <tr> <td><b>S:</b> IR SR HR AR TC DM LR #</td> <td><b>Di:</b> IR HR AR TC DM LR #</td> <td><b>D:</b> IR SR HR AR TC DM LR</td> </tr> </table>	<b>S:</b> IR SR HR AR TC DM LR #	<b>Di:</b> IR HR AR TC DM LR #	<b>D:</b> IR SR HR AR TC DM LR	All models
MOVD(83)											
S											
Di											
D											
<b>S:</b> IR SR HR AR TC DM LR #	<b>Di:</b> IR HR AR TC DM LR #	<b>D:</b> IR SR HR AR TC DM LR									
<b>Data Exchange</b> (@)XCHG(73)	<table border="1"> <tr><td>XCHG(73)</td></tr> <tr><td>E1</td></tr> <tr><td>E2</td></tr> </table>	XCHG(73)	E1	E2	<p>Exchanges contents of two different words (E1 and E2).</p>	<table border="1"> <tr><td><b>E1/E2:</b> IR HR AR TC DM LR</td></tr> </table>	<b>E1/E2:</b> IR HR AR TC DM LR	All models			
XCHG(73)											
E1											
E2											
<b>E1/E2:</b> IR HR AR TC DM LR											

Name Mnemonic	Symbol	Function	Operands	CPU
<b>BCD to Binary</b> (@)BIN(23)		Converts four-digit, BCD data in source word (S) into 16-bit binary data, and outputs converted data to result word (R). 	<b>S:</b> IR SR HR AR TC DM LR <b>R:</b> IR HR AR DM LR	All models
<b>Double BCD to Double Binary</b> (@)BINL(58)		Converts BCD value in two source words (S: starting word) into binary and outputs converted data to two result words (R: starting word). All words for any one operand must be in the same data area. 	<b>S:</b> IR SR HR AR TC DM LR <b>R:</b> IR HR AR DM LR	All models C1000H C2000H
<b>Binary to BCD</b> (@)BCD(24)		Converts binary data in source word (S) into BCD, and outputs converted data to result word (R). 	<b>S:</b> IR SR HR AR DM LR <b>R:</b> IR HR AR DM LR	All models
<b>Double Binary to Double BCD</b> (@)BCDL(59)		Converts binary value in two source words (S: starting word) into eight digits of BCD data, and outputs converted data to two result words (R: starting result word). Both words for any one operand must be in the same data area. 	<b>S:</b> IR SR HR AR DM LR <b>R:</b> IR HR AR DM LR	All models C1000H C2000H
<b>4 to 16 Decoder</b> (@)MLPX(76)		Converts up to four hexadecimal digits in source word (S) into decimal values from 0 to 15 and turns ON, in result word(s) (R), bit(s) whose position corresponds to converted value. Digits to be converted designated by Di (rightmost digit: indicates the first digit; next digit to left: gives the number of digits minus 1). 	<b>S:</b> IR SR HR AR TC DM LR <b>Di:</b> IR HR AR TC DM LR # <b>R:</b> IR HR AR DM LR	All models
<b>8 to 256 Decoder</b> (@)MLPX(76)				

Name Mnemonic	Symbol	Function	Operands	CPU		
<b>16 to 4 Encoder</b> (@)DMPX(77)		Determines position of highest ON bit in source word(s) (starting word: S) and turns ON corresponding bit(s) in result word (R). Digits to receive converted value are designated by Di (rightmost digit: indicates the first digit; next digit to left: gives number of words to be converted minus 1).	<b>S:</b> IR SR HR AR TC DM LR	<b>R:</b> IR HR AR DM LR	<b>Di:</b> IR HR AR TC DM LR #	All models
						<b>256 to 8 Encoder</b> (@)DMPX(77)
<b>7-Segment Decoder</b> (@)SDEC(78)		Converts hexadecimal values from source word (S) to data for seven-segment display. Results placed in consecutive half words starting at the first destination word (D). Di designates digit and destination details (rightmost digit: gives the first digit to be converted; next digit to the left: number of digits to be converted minus 1; next digit: 1 = transfer first digit to left half of first destination word, 0 = transfer to right half).	<b>S:</b> IR SR HR AR TC DM LR	<b>Di:</b> IR HR AR TC DM LR #	<b>D:</b> IR HR AR DM LR	All models
<b>ASCII Code Convert</b> (@)ASC(86)		Converts hexadecimal values from source word (S) to eight-bit ASCII code starting at leftmost or rightmost half of starting destination word (D). Rightmost digit of Di designates first source digit; the next digit to the left, the number of digits; the next digit, the rightmost (1) or leftmost (0) half of the first destination word; and the leftmost digit even (1) or odd (0) parity.	<b>S:</b> IR SR HR AR TC DM LR	<b>Di:</b> IR HR TC DM LR #	<b>D:</b> IR HR DM LR	All models
<b>ASCII to Hex</b> (@)HEX(*)		Converts ASCII data to hexadecimal data.	<b>S:</b> IR SR HR AR TC DM LR	<b>Di:</b> IR SR HR AR TC DM LR	<b>D:</b> IR SR HR AR TC DM LR	HS-CPU's
<b>Hours-to-Seconds</b> (@)HTS(65)		Converts a time given in hours/minutes/seconds (S and S+1) to an equivalent time in seconds only (R and R+1). S and S+1 must be BCD and within one data area. R and R+1 must also be within one data area.	<b>S:</b> IR SR HR AR LR TC DM	<b>R:</b> IR SR HR AR LR TC DM	-: Not used	CPU21 CPU23 CPU31 HS-CPU's



Name Mnemonic	Symbol	Function	Operands			CPU					
<b>Seconds-to-Hours</b> (@)STH(66)	<table border="1"> <tr><td>—</td></tr> <tr><td>STH(66)</td></tr> <tr><td>S</td></tr> <tr><td>R</td></tr> <tr><td>—</td></tr> </table>	—	STH(66)	S	R	—	Converts a time given in seconds (S and S+1) to an equivalent time in hours/minutes/seconds (R and R+1). S and S+1 must be BCD between 0 and 35,999,999, and within the same data area. R and R+1 must also be within one data area.	<b>S:</b> IR SR HR AR LR TC DM	<b>R:</b> IR SR HR AR LR TC DM	<b>—:</b> Not used	CPU21 CPU23 CPU31 HS-CPU's
—											
STH(66)											
S											
R											
—											
<b>2's Complement</b> (@)NEG(*)	<table border="1"> <tr><td>—</td></tr> <tr><td>NEG(-)</td></tr> <tr><td>S</td></tr> <tr><td>R</td></tr> </table>	—	NEG(-)	S	R	Converts the four digit hexadecimal content of the source word to its 2's complement and outputs the result to R	<b>S:</b> IR SR AR DM HR TC LR #	<b>R:</b> IR SR AR DM HR LR		HS-CPU's	
—											
NEG(-)											
S											
R											
<b>Double 2's Complement</b> (@)NEGL(*)	<table border="1"> <tr><td>—</td></tr> <tr><td>NEGL(-)</td></tr> <tr><td>S</td></tr> <tr><td>R</td></tr> <tr><td>—</td></tr> </table>	—	NEGL(-)	S	R	—	Converts the eight-digit hexadecimal content of the source word to its 2's complement and outputs the result to R.	<b>S:</b> IR SR AR DM HR TC LR	<b>R:</b> IR SR AR DM HR LR		HS-CPU's
—											
NEGL(-)											
S											
R											
—											
<b>7-Segment Display Output</b> 7SEG(*)	<table border="1"> <tr><td>—</td></tr> <tr><td>7SEG(-)</td></tr> <tr><td>S</td></tr> <tr><td>O</td></tr> <tr><td>C</td></tr> </table>	—	7SEG(-)	S	O	C	Converts 4- or 8- BCD data to 7-segment display format and then outputs the converted data.	<b>S:</b> IR SR AR DM HR TC LR	<b>O:</b> IR SR AR HR LR	<b>C:</b> 000 to 007	HS-CPU's
—											
7SEG(-)											
S											
O											
C											

Name Mnemonic	Symbol	Function	Operands	CPU				
<b>Increment</b> (@)INC(38)	— <table border="1" style="display: inline-table; vertical-align: middle;"><tr><td>INC(38)</td></tr><tr><td>Wd</td></tr></table>	INC(38)	Wd	Increments four-digit BCD word (Wd) by one, without affecting carry (CY).	<b>Wd:</b> IR HR AR DM LR	All models		
INC(38)								
Wd								
<b>Decrement</b> (@)DEC(39)	— <table border="1" style="display: inline-table; vertical-align: middle;"><tr><td>DEC(39)</td></tr><tr><td>Wd</td></tr></table>	DEC(39)	Wd	Decrements four-digit BCD word by 1, without affecting carry (CY).	<b>Wd:</b> IR HR AR DM LR	All models		
DEC(39)								
Wd								
<b>Set Carry</b> (@)STC(40)	— <table border="1" style="display: inline-table; vertical-align: middle;"><tr><td>STC(40)</td></tr></table>	STC(40)	Sets carry flag (i.e., turns CY ON).	None	All models			
STC(40)								
<b>Clear Carry</b> (@)CLC(41)	— <table border="1" style="display: inline-table; vertical-align: middle;"><tr><td>CLC(41)</td></tr></table>	CLC(41)	CLC clears carry flag (i.e, turns CY OFF).	None	All models			
CLC(41)								
<b>BCD Add</b> (@)ADD(30)	— <table border="1" style="display: inline-table; vertical-align: middle;"><tr><td>ADD(30)</td></tr><tr><td>Au</td></tr><tr><td>Ad</td></tr><tr><td>R</td></tr></table>	ADD(30)	Au	Ad	R	Adds two four-digit BCD values (Au and Ad) and content of CY, and outputs result to specified result word (R). $\boxed{\text{Au}} + \boxed{\text{Ad}} + \boxed{\text{CY}} \rightarrow \boxed{\text{CY}} \boxed{\text{R}}$	<b>Au/Ad:</b> IR SR HR AR TC DM LR # <b>R:</b> IR HR AR DM LR	All models
ADD(30)								
Au								
Ad								
R								
<b>Double BCD Add</b> (@)ADDL(54)	— <table border="1" style="display: inline-table; vertical-align: middle;"><tr><td>ADDL(54)</td></tr><tr><td>Au</td></tr><tr><td>Ad</td></tr><tr><td>R</td></tr></table>	ADDL(54)	Au	Ad	R	Adds two eight-digit values (2 words each) and content of CY, and outputs result to specified result words. All words for any one operand must be in the same data area. $\boxed{\text{Au}+1} \boxed{\text{Au}} + \boxed{\text{Ad}+1} \boxed{\text{Ad}} + \boxed{\text{CY}} \rightarrow \boxed{\text{CY}} \boxed{\text{R}+1} \boxed{\text{R}}$	<b>Au/Ad:</b> IR SR HR AR TC DM LR <b>R:</b> IR HR AR DM LR	All models
ADDL(54)								
Au								
Ad								
R								
<b>BCD Subtract</b> (@)SUB(31)	— <table border="1" style="display: inline-table; vertical-align: middle;"><tr><td>SUB(31)</td></tr><tr><td>Mi</td></tr><tr><td>Su</td></tr><tr><td>R</td></tr></table>	SUB(31)	Mi	Su	R	Subtracts both four-digit BCD subtrahend (Su) and content of CY from four-digit BCD minuend (Mi) and outputs result to specified result word (R). $\boxed{\text{Mi}} - \boxed{\text{Su}} - \boxed{\text{CY}} \rightarrow \boxed{\text{CY}} \boxed{\text{R}}$	<b>Mi/Su:</b> IR SR HR AR TC DM LR # <b>R:</b> IR HR AR DM LR	All models
SUB(31)								
Mi								
Su								
R								
<b>Double BCD Subtract</b> (@)SUBL(55)	— <table border="1" style="display: inline-table; vertical-align: middle;"><tr><td>SUBL(55)</td></tr><tr><td>Mi</td></tr><tr><td>Su</td></tr><tr><td>R</td></tr></table>	SUBL(55)	Mi	Su	R	Subtracts both eight-digit BCD subtrahend and content of CY from eight-digit BCD minuend and outputs result to specified result words. All words for any one operand must be in the same data area. $\boxed{\text{Mi}+1} \boxed{\text{Mi}} - \boxed{\text{Su}+1} \boxed{\text{Su}} - \boxed{\text{CY}} \rightarrow \boxed{\text{CY}} \boxed{\text{R}+1} \boxed{\text{R}}$	<b>Mi/Su:</b> IR SR HR AR TC DM LR <b>R:</b> IR HR AR DM LR	All models
SUBL(55)								
Mi								
Su								
R								
<b>BCD Multiply</b> (@)MUL(32)	— <table border="1" style="display: inline-table; vertical-align: middle;"><tr><td>MUL(32)</td></tr><tr><td>Md</td></tr><tr><td>Mr</td></tr><tr><td>R</td></tr></table>	MUL(32)	Md	Mr	R	Multiplies four-digit BCD multiplicand (Md) and four-digit BCD multiplier (Mr) and outputs result to specified result words (R and R + 1). R and R + 1 must be in the same data area. $\boxed{\text{Md}} \times \boxed{\text{Mr}} \rightarrow \boxed{\text{R}+1} \boxed{\text{R}}$	<b>Md/Mr:</b> IR SR HR AR TC DM LR # <b>R:</b> IR HR AR DM LR	All models
MUL(32)								
Md								
Mr								
R								

Name Mnemonic	Symbol	Function	Operands	CPU																				
<b>Double BCD Multiply</b> (@)MULL(56)	<table border="1"> <tr><td>MULL(56)</td></tr> <tr><td>Md</td></tr> <tr><td>Mr</td></tr> <tr><td>R</td></tr> </table>	MULL(56)	Md	Mr	R	<p>Multiplies eight-digit BCD multiplicand and eight-digit BCD multiplier and outputs result to specified result words. All words for any one operand must be in the same data area.</p> $\begin{array}{ c c } \hline \text{Md+1} & \text{Md} \\ \hline \end{array} \times \begin{array}{ c c } \hline \text{Mr+1} & \text{Mr} \\ \hline \end{array}$ $\rightarrow \begin{array}{ c c c c } \hline \text{R+3} & \text{R+2} & \text{R+1} & \text{R} \\ \hline \end{array}$	<table border="1"> <tr><td><b>Md/Mr:</b></td></tr> <tr><td>IR</td></tr> <tr><td>SR</td></tr> <tr><td>HR</td></tr> <tr><td>AR</td></tr> <tr><td>TC</td></tr> <tr><td>DM</td></tr> <tr><td>LR</td></tr> </table>	<b>Md/Mr:</b>	IR	SR	HR	AR	TC	DM	LR	<table border="1"> <tr><td><b>R:</b></td></tr> <tr><td>IR</td></tr> <tr><td>HR</td></tr> <tr><td>AR</td></tr> <tr><td>DM</td></tr> <tr><td>LR</td></tr> </table>	<b>R:</b>	IR	HR	AR	DM	LR	All models	
MULL(56)																								
Md																								
Mr																								
R																								
<b>Md/Mr:</b>																								
IR																								
SR																								
HR																								
AR																								
TC																								
DM																								
LR																								
<b>R:</b>																								
IR																								
HR																								
AR																								
DM																								
LR																								
<b>BCD Divide</b> (@)DIV(33)	<table border="1"> <tr><td>DIV(33)</td></tr> <tr><td>Dd</td></tr> <tr><td>Dr</td></tr> <tr><td>R</td></tr> </table>	DIV(33)	Dd	Dr	R	<p>Divides four-digit BCD dividend (Dd) by four-digit BCD divisor (Dr) and outputs result to specified result words. R receives quotient; R + 1 receives remainder. R and R + 1 must be in the same data area.</p> $\begin{array}{ c } \hline \text{Dd} \\ \hline \end{array} \div \begin{array}{ c } \hline \text{Dr} \\ \hline \end{array} \rightarrow \begin{array}{ c c } \hline \text{R+1} & \text{R} \\ \hline \end{array}$	<table border="1"> <tr><td><b>Dd/Dr:</b></td></tr> <tr><td>IR</td></tr> <tr><td>SR</td></tr> <tr><td>HR</td></tr> <tr><td>AR</td></tr> <tr><td>TC</td></tr> <tr><td>DM</td></tr> <tr><td>LR</td></tr> <tr><td>#</td></tr> </table>	<b>Dd/Dr:</b>	IR	SR	HR	AR	TC	DM	LR	#	<table border="1"> <tr><td><b>R:</b></td></tr> <tr><td>IR</td></tr> <tr><td>HR</td></tr> <tr><td>AR</td></tr> <tr><td>DM</td></tr> <tr><td>LR</td></tr> </table>	<b>R:</b>	IR	HR	AR	DM	LR	All models
DIV(33)																								
Dd																								
Dr																								
R																								
<b>Dd/Dr:</b>																								
IR																								
SR																								
HR																								
AR																								
TC																								
DM																								
LR																								
#																								
<b>R:</b>																								
IR																								
HR																								
AR																								
DM																								
LR																								
<b>Double BCD Divide</b> (@)DIVL(57)	<table border="1"> <tr><td>DIVL(57)</td></tr> <tr><td>Dd</td></tr> <tr><td>Dr</td></tr> <tr><td>R</td></tr> </table>	DIVL(57)	Dd	Dr	R	<p>Divides eight-digit BCD dividend by eight-digit BCD divisor and outputs result to specified result words. All words for any one operand must be in the same data area.</p> $\begin{array}{ c c } \hline \text{Dd+1} & \text{Dd} \\ \hline \end{array} \div \begin{array}{ c c } \hline \text{Dr+1} & \text{Dr} \\ \hline \end{array}$ $\rightarrow \begin{array}{ c c } \hline \text{Quotient} & \text{R+1} & \text{R} \\ \hline \end{array}$ $\begin{array}{ c c } \hline \text{Remainder} & \text{R+3} & \text{R+2} \\ \hline \end{array}$	<table border="1"> <tr><td><b>Dd/Dr:</b></td></tr> <tr><td>IR</td></tr> <tr><td>SR</td></tr> <tr><td>HR</td></tr> <tr><td>AR</td></tr> <tr><td>TC</td></tr> <tr><td>DM</td></tr> <tr><td>LR</td></tr> </table>	<b>Dd/Dr:</b>	IR	SR	HR	AR	TC	DM	LR	<table border="1"> <tr><td><b>R:</b></td></tr> <tr><td>IR</td></tr> <tr><td>HR</td></tr> <tr><td>AR</td></tr> <tr><td>DM</td></tr> <tr><td>LR</td></tr> </table>	<b>R:</b>	IR	HR	AR	DM	LR	All models	
DIVL(57)																								
Dd																								
Dr																								
R																								
<b>Dd/Dr:</b>																								
IR																								
SR																								
HR																								
AR																								
TC																								
DM																								
LR																								
<b>R:</b>																								
IR																								
HR																								
AR																								
DM																								
LR																								
<b>Floating Point Divide</b> (@)FDIV(79)	<table border="1"> <tr><td>FDIV(79)</td></tr> <tr><td>Dd</td></tr> <tr><td>Dr</td></tr> <tr><td>R</td></tr> </table>	FDIV(79)	Dd	Dr	R	<p>Divides one floating point value by another and outputs floating point result. Rightmost seven digits of each set of two words (eight digits) are used for mantissa, and leftmost digit used for the exponent and its sign.</p> $\begin{array}{ c c } \hline \text{Dd+1} & \text{Dd} \\ \hline \end{array} \div \begin{array}{ c c } \hline \text{Dr+1} & \text{Dr} \\ \hline \end{array}$ $\rightarrow \begin{array}{ c c } \hline \text{R+1} & \text{R} \\ \hline \end{array}$	<table border="1"> <tr><td><b>Dd/Dr:</b></td></tr> <tr><td>IR</td></tr> <tr><td>SR</td></tr> <tr><td>HR</td></tr> <tr><td>AR</td></tr> <tr><td>TC</td></tr> <tr><td>DM</td></tr> <tr><td>LR</td></tr> </table>	<b>Dd/Dr:</b>	IR	SR	HR	AR	TC	DM	LR	<table border="1"> <tr><td><b>R:</b></td></tr> <tr><td>IR</td></tr> <tr><td>HR</td></tr> <tr><td>AR</td></tr> <tr><td>DM</td></tr> <tr><td>LR</td></tr> </table>	<b>R:</b>	IR	HR	AR	DM	LR	All models	
FDIV(79)																								
Dd																								
Dr																								
R																								
<b>Dd/Dr:</b>																								
IR																								
SR																								
HR																								
AR																								
TC																								
DM																								
LR																								
<b>R:</b>																								
IR																								
HR																								
AR																								
DM																								
LR																								
<b>Square Root</b> (@)ROOT(72)	<table border="1"> <tr><td>ROOT(72)</td></tr> <tr><td>Sq</td></tr> <tr><td>R</td></tr> </table>	ROOT(72)	Sq	R	<p>Computes square root of eight-digit BCD value (Sq and Sq + 1) and outputs truncated four-digit integer result to specified result word (R). Sq and Sq + 1 must be in the same data area.</p> $\sqrt{\begin{array}{ c c } \hline \text{Sq+1} & \text{Sq} \\ \hline \end{array}}$ $\begin{array}{ c } \hline \text{R} \\ \hline \end{array}$	<table border="1"> <tr><td><b>Sq:</b></td></tr> <tr><td>IR</td></tr> <tr><td>SR</td></tr> <tr><td>HR</td></tr> <tr><td>AR</td></tr> <tr><td>TC</td></tr> <tr><td>DM</td></tr> <tr><td>LR</td></tr> </table>	<b>Sq:</b>	IR	SR	HR	AR	TC	DM	LR	<table border="1"> <tr><td><b>R:</b></td></tr> <tr><td>IR</td></tr> <tr><td>HR</td></tr> <tr><td>AR</td></tr> <tr><td>DM</td></tr> <tr><td>LR</td></tr> </table>	<b>R:</b>	IR	HR	AR	DM	LR	All models		
ROOT(72)																								
Sq																								
R																								
<b>Sq:</b>																								
IR																								
SR																								
HR																								
AR																								
TC																								
DM																								
LR																								
<b>R:</b>																								
IR																								
HR																								
AR																								
DM																								
LR																								

Name Mnemonic	Symbol	Function	Operands	CPU				
<b>Binary Add</b> (@)ADB(50)	<table border="1"> <tr><td>ADB(50)</td></tr> <tr><td>Au</td></tr> <tr><td>Ad</td></tr> <tr><td>R</td></tr> </table>	ADB(50)	Au	Ad	R	Adds four-digit augend (Au), four-digit addend (Ad), and content of CY and outputs result to specified result word (R). $\boxed{Au} + \boxed{Ad} + \boxed{CY} \rightarrow \boxed{CY} \boxed{R}$	<b>Au/Ad:</b> IR SR HR AR TC DM LR # <b>R:</b> IR HR AR DM LR	All models
ADB(50)								
Au								
Ad								
R								
<b>Binary Subtract</b> (@)SBB(51)	<table border="1"> <tr><td>SBB(51)</td></tr> <tr><td>Mi</td></tr> <tr><td>Su</td></tr> <tr><td>R</td></tr> </table>	SBB(51)	Mi	Su	R	Subtracts four-digit hexadecimal subtrahend (Su) and content of carry from four-digit hexadecimal minuend (Mi) and outputs result to specified result word (R). $\boxed{Mi} - \boxed{Su} - \boxed{CY} \rightarrow \boxed{CY} \boxed{R}$	<b>Mi/Su:</b> IR SR HR AR TC DM LR # <b>R:</b> IR HR AR DM LR	All models
SBB(51)								
Mi								
Su								
R								
<b>Binary Multiply</b> (@)MLB(52)	<table border="1"> <tr><td>MLB(52)</td></tr> <tr><td>Md</td></tr> <tr><td>Mr</td></tr> <tr><td>R</td></tr> </table>	MLB(52)	Md	Mr	R	Multiplies four-digit hexadecimal multiplicand (Md) by four-digit multiplier (Mr) and outputs eight-digit hexadecimal result to specified result words (R and R + 1). R and R + 1 must be in the same data area. $\boxed{Md} \times \boxed{Mr} \rightarrow \boxed{R + 1} \boxed{R}$	<b>Md/Mr:</b> IR SR HR AR TC DM LR # <b>R:</b> IR HR AR DM LR	All models
MLB(52)								
Md								
Mr								
R								
<b>Binary Divide</b> (@)DVB(53)	<table border="1"> <tr><td>DVB(53)</td></tr> <tr><td>Dd</td></tr> <tr><td>Dr</td></tr> <tr><td>R</td></tr> </table>	DVB(53)	Dd	Dr	R	Divides four-digit hexadecimal dividend (Dd) by four-digit divisor (Dr) and outputs result to designated result words (R and R + 1). R and R + 1 must be in the same data area. $\boxed{Dd} \div \boxed{Dr} \rightarrow \boxed{R + 1} \boxed{R}$	<b>Dd/Dr:</b> IR SR HR AR TC DM LR # <b>R:</b> IR HR AR LR	All models
DVB(53)								
Dd								
Dr								
R								
<b>Double Binary ADD</b> (@)ADBL(*)	<table border="1"> <tr><td>ADBL(-)</td></tr> <tr><td>Au</td></tr> <tr><td>Ad</td></tr> <tr><td>R</td></tr> </table>	ADBL(-)	Au	Ad	R	Adds two 8-digit binary valves (normal or signed data) and outputs the result to R and R+1.	<b>Au:</b> IR SR AR DM HR LR <b>Ad:</b> IR SR AR D M HR LR <b>R:</b> IR SR AR D M HR LR	HS-CPU's
ADBL(-)								
Au								
Ad								
R								
<b>Double Binary Subtract</b> (@)SBBL(*)	<table border="1"> <tr><td>SBBL(-)</td></tr> <tr><td>Mi</td></tr> <tr><td>Su</td></tr> <tr><td>R</td></tr> </table>	SBBL(-)	Mi	Su	R	Subtracts an 8-digit binary valves (normal or signed data) from another and outputs the result to R and R+1.	<b>Mi:</b> IR SR AR DM HR TC LR <b>Su:</b> IR SR AR D M HR TC LR <b>R:</b> IR SR AR D M HR LR	HS-CPU's
SBBL(-)								
Mi								
Su								
R								
<b>Signed Binary Divide</b> (@)DBS(*)	<table border="1"> <tr><td>DBS(-)</td></tr> <tr><td>Dd</td></tr> <tr><td>Dr</td></tr> <tr><td>R</td></tr> </table>	DBS(-)	Dd	Dr	R	Divides one 16-bit signed binary valve by another and outputs the 32-bit signed result to R+1 and R	<b>Dd:</b> IR SR AR DM HR TC LR # <b>Dr:</b> IR SR AR D M HR TC LR # <b>R:</b> IR SR AR D M HR LR	HS-CPU's
DBS(-)								
Dd								
Dr								
R								

Name Mnemonic	Symbol	Function	Operands			CPU				
<b>Double Signed Binary Divide</b> (@)DBSL(*)	<table border="1"> <tr><td>DBSL(-)</td></tr> <tr><td>Dd</td></tr> <tr><td>Dr</td></tr> <tr><td>R</td></tr> </table>	DBSL(-)	Dd	Dr	R	Divides one 32-bit signed binary value by another and outputs the 64-bit signed binary result to R+3 through R	<b>Dd:</b> IR SR AR DM HR TC LR #	<b>Dr:</b> IR SR AR D M HR TC LR #	<b>R:</b> IR SR AR D M HR LR	HS-CPU's
DBSL(-)										
Dd										
Dr										
R										
<b>Signed Binary Multiply</b> (@)MBS(*)	<table border="1"> <tr><td>MBS(-)</td></tr> <tr><td>Md</td></tr> <tr><td>Mr</td></tr> <tr><td>R</td></tr> </table>	MBS(-)	Md	Mr	R	Multiplies the signed binary content of two words and outputs the 8-digit signed binary result to R+1 and R	<b>Md:</b> IR SR AR DM HR TC LR #	<b>Mr:</b> : IR SR AR D M HR TC LR #	<b>R:</b> IR SR AR D M HR LR	HS-CPU's
MBS(-)										
Md										
Mr										
R										
<b>Double Signed Binary Multiply</b> (@)MBSL(*)	<table border="1"> <tr><td>MBSL(-)</td></tr> <tr><td>Md</td></tr> <tr><td>Mr</td></tr> <tr><td>R</td></tr> </table>	MBSL(-)	Md	Mr	R	Multiplies two 32-bit (8-digit) signed binary values and outputs the 16-digit signed result to R+3 through R.	<b>Md:</b> IR SR AR DM HR TC LR	<b>Mr:</b> : IR SR AR D M HR TC LR	<b>R:</b> IR SR AR D M HR LR	HS-CPU's
MBSL(-)										
Md										
Mr										
R										

Name Mnemonic	Symbol	Function	Operands	CPU
<b>Shift Register</b> SFT(10)		<p>Creates a bit shift register from the starting word (St) through the ending word (E). I: input bit; P: shift pulse; R: reset input. St must be less than or equal to E and St and E must be in the same data area.</p>	<b>St/E:</b> IR HR AR LR	All models
<b>Reversible Shift Register</b> (@)SFTR(84)		<p>Shifts data in specified word or series of words to either left or right. Starting (St) and ending words (E) must be specified. Control word (C) contains shift direction, reset input, and data input. St and E must be in the same data area and St must be less than or equal to E.</p>	<b>St/E/C:</b> IR HR AR TC DM LR	All models
<b>Arithmetic Shift Left</b> (@)ASL(25)		<p>Shifts each bit in single word (Wd) of data one bit to left, with CY.</p>	<b>Wd:</b> IR HR AR DM LR	All models
<b>Arithmetic Shift Right</b> (@)ASR(26)		<p>Shifts each bit in single word (Wd) of data one bit to right, with CY.</p>	<b>Wd:</b> IR HR AR DM LR	All models
<b>Rotate Left</b> (@)ROL(27)		<p>Rotates bits in single word (Wd) of data one bit to left, with carry (CY).</p>	<b>Wd:</b> IR HR AR DM LR	All models
<b>Rotate Right</b> (@)ROR(28)		<p>Rotates bits in single word (Wd) of data one bit to right, with carry (CY).</p>	<b>Wd:</b> IR HR AR DM LR	All models
<b>One Digit Shift Left</b> (@)SLD(74)		<p>Left shifts data between starting (St) and ending (E) words by one digit (four bits). St and E must be in the same data area.</p>	<b>St/E:</b> IR HR AR DM LR	All models

Name Mnemonic	Symbol	Function	Operands	CPU					
<b>One Digit Shift Right</b> (@)SRD(75)	<table border="1"> <tr><td>SRD(75)</td></tr> <tr><td>E</td></tr> <tr><td>St</td></tr> </table>	SRD(75)	E	St	<p>Right shifts data between starting (St) and ending (E) words by one digit (four bits). St and E must be in the same data area.</p>	<b>St/E:</b> IR HR AR DM LR	All models		
SRD(75)									
E									
St									
<b>Word Shift</b> (@)WSFT(16)	<table border="1"> <tr><td>WSFT(16)</td></tr> <tr><td>St</td></tr> <tr><td>E</td></tr> </table>	WSFT(16)	St	E	<p>Left shifts data between starting (St) and ending (E) words in word units, writing zeros into starting word. St must be less than or equal to E and St and E must be in the same data area.</p>	<b>St/E:</b> IR HR AR DM LR	All models		
WSFT(16)									
St									
E									
<b>Reversible Word Shift</b> (@)RWS(17)	<table border="1"> <tr><td>RWS(17)</td></tr> <tr><td>C</td></tr> <tr><td>St</td></tr> <tr><td>E</td></tr> </table>	RWS(17)	C	St	E	<p>Creates and controls a reversible asynchronous word shift register between St and E. This register only shifts words when the next word in the register is zero, e.g., if no words in the register contain zero, nothing is shifted. Also, only one word is shifted for each word in the register that contains zero. When the contents of a word are shifted to the next word, the original word's contents are set to zero. In essence, when the register is shifted, each zero word in the register trades places with the next word. The shift direction (i.e. whether the next word is the next higher or the next lower word) is designated in C. C is also used to reset the register. All of any portion of the register can be reset by designating the desired portion with St and E.</p>	<b>C</b> IR HR AR DM LR #	<b>St/E:</b> IR HR AR DM LR	CPU21 CPU23 CPU31 HS-CPU's
RWS(17)									
C									
St									
E									

Name Mnemonic	Symbol	Function	Operands	CPU				
<b>Complement</b> (@)COM(29)	— <table border="1" style="display: inline-table; vertical-align: middle;"><tr><td>COM(29)</td></tr><tr><td>Wd</td></tr></table>	COM(29)	Wd	Inverts bit status of one word (Wd) of data. $Wd \rightarrow \overline{Wd}$	<b>Wd:</b> IR HR AR DM LR	All models		
COM(29)								
Wd								
<b>Logical AND</b> (@)ANDW(34)	— <table border="1" style="display: inline-table; vertical-align: middle;"><tr><td>ANDW(34)</td></tr><tr><td>I1</td></tr><tr><td>I2</td></tr><tr><td>R</td></tr></table>	ANDW(34)	I1	I2	R	Logically ANDs two 16-bit input words (I1 and I2) and sets corresponding bit in result word (R) if corresponding bits in input words are both ON.	<b>I1/I2:</b> IR SR HR AR TC DM LR # <b>R:</b> IR HR AR DM LR	All models
ANDW(34)								
I1								
I2								
R								
<b>Logical OR</b> (@)ORW(35)	— <table border="1" style="display: inline-table; vertical-align: middle;"><tr><td>ORW(35)</td></tr><tr><td>I1</td></tr><tr><td>I2</td></tr><tr><td>R</td></tr></table>	ORW(35)	I1	I2	R	Logically ORs two 16-bit input words (I1 and I2) and sets corresponding bit in result word (R) if one or both of corresponding bits in input data are ON.	<b>I1/I2:</b> IR SR HR AR TC DM LR # <b>R:</b> IR HR AR DM LR	All models
ORW(35)								
I1								
I2								
R								
<b>Exclusive OR</b> (@)XORW(36)	— <table border="1" style="display: inline-table; vertical-align: middle;"><tr><td>XORW(36)</td></tr><tr><td>I1</td></tr><tr><td>I2</td></tr><tr><td>R</td></tr></table>	XORW(36)	I1	I2	R	Exclusively ORs two 16-bit input words (I1 and I2) and sets bit in result (R) word when corresponding bits in input words differ in status.	<b>I1/I2:</b> IR SR HR AR TC DM LR # <b>R:</b> IR HR AR DM LR	All models
XORW(36)								
I1								
I2								
R								
<b>Exclusive NOR</b> (@)XNRW(37)	— <table border="1" style="display: inline-table; vertical-align: middle;"><tr><td>XNRW(37)</td></tr><tr><td>I1</td></tr><tr><td>I2</td></tr><tr><td>R</td></tr></table>	XNRW(37)	I1	I2	R	Exclusively NORs two 16-bit input words (I1 and I2) and sets bit in result word (R) when corresponding bits in input words are same in status.	<b>I1/I2:</b> IR SR HR AR TC DM LR # <b>R:</b> IR HR AR DM LR	All models
XNRW(37)								
I1								
I2								
R								



Name Mnemonic	Symbol	Function	Operands	CPU				
<b>Subroutine Define</b> SBS(91)	— <span style="border: 1px solid black; padding: 2px;">SBS(91) N</span>	Calls and executes subroutine N.	<b>N:</b> 00 to 99	All models				
<b>Subroutine Entry</b> SBN(92)	— <span style="border: 1px solid black; padding: 2px;">SBN(92) N</span>	Marks start of subroutine N.	<b>N:</b> 00 to 99	All models				
<b>Subroutine Return</b> RET(93)	— <span style="border: 1px solid black; padding: 2px;">RET(93)</span>	Marks the end of a subroutine and returns control to main program.	None	All models				
<b>Macro</b> (@)MCRO(99)	— <table border="1" style="display: inline-table; vertical-align: middle;"> <tr><td style="padding: 2px;">XNRW(37)</td></tr> <tr><td style="padding: 2px;">I1</td></tr> <tr><td style="padding: 2px;">I2</td></tr> <tr><td style="padding: 2px;">R</td></tr> </table>	XNRW(37)	I1	I2	R	Calls and executes a subroutine replacing I/O words but keeping the same subroutine structure.	<b>N:</b> 00 to 99 <b>I1:</b> IR SR AR DM HR TC LR <b>O1:</b> IR SR AR DM HR LR	HS-CPU's
XNRW(37)								
I1								
I2								
R								

Name Mnemonic	Symbol	Function	Operands	CPU
<b>Step Define</b> STEP(08)	— <span style="border: 1px solid black; padding: 2px;">STEP(08) B</span>	When used with a control bit (B), defines the start of a new step and resets the previous step. When used without N, defines the end of step execution.	<b>B:</b> IR HR AR LR	All models
<b>Step Start</b> SNXT(09)	— <span style="border: 1px solid black; padding: 2px;">SNXT(09) B</span>	Used with a control bit (B) to indicate the end of the step, reset the step, and start the next step.	<b>B:</b> IR HR AR LR	All models

Name Mnemonic	Symbol	Function	Operands	CPU															
<b>Failure Alarm and Reset</b> FAL(06)	— <table border="1"><tr><td>FAL(06) N</td></tr></table>	FAL(06) N	FAL is displayed on a programming device. When N is 01 to 99, an error that will not stop the CPU is indicated by outputting N (the FAL number) to the FAL output area. If N is 00, any data in the FAL output area is cleared and any other FAL number recorded in memory replaces it. The same FAL numbers are used for both FAL(06) and FALS(07).	<b>N:</b> 00 to 99	All models														
FAL(06) N																			
<b>Severe Failure Alarm</b> FALS(07)	— <table border="1"><tr><td>FALS(07) N</td></tr></table>	FALS(07) N	An error is indicated by outputting N to the FAL output area and the CPU is stopped. The same FAL numbers are used for both FAL(06) and FALS(07).	<b>N:</b> 01 to 99	All models														
FALS(07) N																			
<b>Message Display</b> (@)MSG(46)	— <table border="1"><tr><td>MSG(46)</td></tr><tr><td>FM</td></tr></table>	MSG(46)	FM	Displays on the Programming Console, GPC, or FIT 8 words of ASCII code starting from FM. All 8 words must be in the same data area.  <div style="text-align: center;"> <table border="1"> <tr><td>FM</td><td>A</td><td>B</td></tr> <tr><td></td><td>C</td><td>D</td></tr> <tr><td></td><td colspan="2">⋮</td></tr> <tr><td>FM+ 7</td><td>O</td><td>P</td></tr> </table> <p>↓</p> <table border="1"> <tr><td>ABCD.....OP</td></tr> </table> </div>	FM	A	B		C	D		⋮		FM+ 7	O	P	ABCD.....OP	<b>FM:</b> IR HR AR TC DM LR #	All models
MSG(46)																			
FM																			
FM	A	B																	
	C	D																	
	⋮																		
FM+ 7	O	P																	
ABCD.....OP																			
<b>Bit Counter</b> BCNT(67)	— <table border="1"><tr><td>BCNT(67)</td></tr><tr><td>N</td></tr><tr><td>SB</td></tr><tr><td>R</td></tr></table>	BCNT(67)	N	SB	R	Counts number of ON bits in one or more words (SB: source beginning word) and outputs result to specified word (R). N: number of words to be counted . All words to be counted must be in the same data area.	<b>N:</b> IR SR HR AR TC DM LR <b>SB:</b> IR SR HR AR TC DM LR <b>R:</b> IR HR AR TC DM LR	All models HS-CPU's											
BCNT(67)																			
N																			
SB																			
R																			
<b>Interrupt Control</b> (@)FUN(89)	— <table border="1"><tr><td>FUN(89)</td></tr><tr><td>CC</td></tr><tr><td>N</td></tr><tr><td>D</td></tr></table>	FUN(89)	CC	N	D	Controls interrupts. CC: control code (defines the process); N: Interrupt Module unit number (004: scheduled interrupt); D: control data.	<b>CC:</b> 000 to 002 <b>N:</b> 000 to 004 <b>D:</b> IR HR AR TC DM LR #	All models HS-CPU's											
FUN(89)																			
CC																			
N																			
D																			
<b>Watchdog Timer Refresh</b> (@)WDT(94)	— <table border="1"><tr><td>WDT(94) T</td></tr></table>	WDT(94) T	Sets the maximum and minimum limits for the watchdog timer (normally 0 to 130 ms). New limits: Maximum time = 130 + (100 x T) Minimum time = 130 + (100 x (T-1))	<b>T:</b> 0 to 63	All models														
WDT(94) T																			
<b>I/O Refresh</b> (@)IORF(97)	— <table border="1"><tr><td>IORF(97)</td></tr><tr><td>St</td></tr><tr><td>E</td></tr></table>	IORF(97)	St	E	Refreshes all I/O words between the start (St) and end (E) words. Only I/O words may be designated. Normally these words are refreshed only once per scan, but refreshing words before use in an instruction can increase execution speed. St must be less than or equal to E.	<b>St/E:</b> IR	All models												
IORF(97)																			
St																			
E																			
<b>Scan Time</b> (@)SCAN(18)	— <table border="1"><tr><td>SCAN(18)</td></tr><tr><td>Mi</td></tr><tr><td>—</td></tr><tr><td>—</td></tr></table>	SCAN(18)	Mi	—	—	Sets the minimum scan time, Mi, in tenths of milliseconds. The possible setting range is from 0 to 999.0 ms. If the actual scan time is less than the time set using SCAN(18), the CPU will wait until the designated time has elapsed before starting the next scan.	<b>Mi:</b> IR SR HR AR LR TC DM # <b>—:</b> Not used	CPU21 CPU23 CPU31 HS-CPU's											
SCAN(18)																			
Mi																			
—																			
—																			

Name Mnemonic	Symbol	Function	Operands	CPU																												
<b>Long Message</b> (@)LMSG(47)	<table border="1"> <tr><td>LMSG(47)</td></tr> <tr><td>S</td></tr> <tr><td>D</td></tr> <tr><td>—</td></tr> </table>	LMSG(47)	S	D	—	Outputs a 32-character message to either a Programming Console, or a device connected via the RS-232C interface. The output message must be in ASCII beginning at address S. The destination of the message is designated in D: 000 specifies that the message is to be output to the GPC; 001 specifies the RS-232C interface, starting with the leftmost byte; and 002 specifies the RS-232C interface, starting from the rightmost byte.	<table border="1"> <tr><td><b>S:</b></td><td><b>D:</b></td><td><b>—:</b></td></tr> <tr><td>IR</td><td>#000</td><td>Not used.</td></tr> <tr><td>HR</td><td>#001</td><td></td></tr> <tr><td>AR</td><td>#002</td><td></td></tr> <tr><td>LR</td><td></td><td></td></tr> <tr><td>TC</td><td></td><td></td></tr> <tr><td>DM</td><td></td><td></td></tr> </table>	<b>S:</b>	<b>D:</b>	<b>—:</b>	IR	#000	Not used.	HR	#001		AR	#002		LR			TC			DM			CPU21 CPU23 CPU31 HS-CPU's			
LMSG(47)																																
S																																
D																																
—																																
<b>S:</b>	<b>D:</b>	<b>—:</b>																														
IR	#000	Not used.																														
HR	#001																															
AR	#002																															
LR																																
TC																																
DM																																
<b>Terminal Mode</b> (@)TERM(48)	<table border="1"> <tr><td>TERM(48)</td></tr> <tr><td>—</td></tr> <tr><td>—</td></tr> <tr><td>—</td></tr> </table>	TERM(48)	—	—	—	When the execution condition is ON, the Programming Console operation mode is changed to TERMINAL mode. There is no program command available to change the mode back to CONSOLE mode. Pressing the CHNG key on the Programming Console manually toggles between the two modes.	—: Not used	CPU21 CPU23 CPU31 HS-CPU's																								
TERM(48)																																
—																																
—																																
—																																
<b>Set System</b> (@)SYS(49)	<table border="1"> <tr><td>SYS(49)</td></tr> <tr><td>P</td></tr> <tr><td>—</td></tr> <tr><td>—</td></tr> </table>	SYS(49)	P	—	—	SYS(49) must be programmed at program address 00001 with LD AR 1001 at program address 00000. The leftmost 8 bits of P must contain A3. The status of bits 00, 01, 06, and 07 are used to control the 4 operating parameters described below. If bit 00 of P is ON, the battery check will be excluded from system error checks. If bit 01 of P is ON, the PC will enter MONITOR mode at startup, unless a Programming Console connected to the CPU is not set to MONITOR. If bit 06 of P is ON, the Force Status Hold Bit (SR 25211) will be effective at startup. If bit 07 of P is ON, the I/O Status Hold Bit (SR 25212) will be effective at startup.	<table border="1"> <tr><td><b>P:</b></td><td><b>—:</b></td></tr> <tr><td>#</td><td>Not used</td></tr> </table>	<b>P:</b>	<b>—:</b>	#	Not used	CPU21 CPU23 CPU31																				
SYS(49)																																
P																																
—																																
—																																
<b>P:</b>	<b>—:</b>																															
#	Not used																															
<b>High-density I/O Refresh</b> MPRF(61)	<table border="1"> <tr><td>MPRF(61)</td></tr> <tr><td>St</td></tr> <tr><td>E</td></tr> </table>	MPRF(61)	St	E	Refreshes I/O words allocated to the IR area Group 2 High-density I/O Modules with I/O numbers St through E. This will be in addition to the normal I/O refresh performed during the CPU's scan. MPRF(61) can be used to refresh the I/O words allocated to the IR area High-density I/O Modules (IR 030 to IR 049) only. Normally these words are refreshed only once per scan, but refreshing words before use in an instruction can increase execution speed. St must be less than or equal to E.	<table border="1"> <tr><td><b>St/E:</b></td></tr> <tr><td># (0000 to 0009)</td></tr> </table>	<b>St/E:</b>	# (0000 to 0009)	CPU21 CPU23 CPU31 HS-CPU's																							
MPRF(61)																																
St																																
E																																
<b>St/E:</b>																																
# (0000 to 0009)																																
<b>Trace Memory Sample</b> TRSM(45)	<table border="1"> <tr><td>TRSM(45)</td></tr> </table>	TRSM(45)	Used in the program to mark locations where specified data is to be stored in TRACE memory. Used with LSS only.	Not used	HS-CPU's																											
TRSM(45)																																
<b>Average Valve</b> AVG(*)	<table border="1"> <tr><td>AVG(-)</td></tr> <tr><td>S</td></tr> <tr><td>N</td></tr> <tr><td>D</td></tr> </table>	AVG(-)	S	N	D	Adds the specified number of hexadecimal words and computes the mean value. Rounds off the 4-digit past the decimal point.	<table border="1"> <tr><td><b>S:</b></td><td><b>N:</b></td><td><b>D:</b></td></tr> <tr><td>IR</td><td>IR</td><td>IR</td></tr> <tr><td>SR</td><td>SR</td><td>SR</td></tr> <tr><td>AR</td><td>AR</td><td>AR</td></tr> <tr><td>DM</td><td>DM</td><td>DM</td></tr> <tr><td>HR</td><td>HR</td><td>HR</td></tr> <tr><td>TC</td><td>TC</td><td>LR</td></tr> <tr><td>LR</td><td>LR</td><td>#</td></tr> </table>	<b>S:</b>	<b>N:</b>	<b>D:</b>	IR	IR	IR	SR	SR	SR	AR	AR	AR	DM	DM	DM	HR	HR	HR	TC	TC	LR	LR	LR	#	HS-CPU's
AVG(-)																																
S																																
N																																
D																																
<b>S:</b>	<b>N:</b>	<b>D:</b>																														
IR	IR	IR																														
SR	SR	SR																														
AR	AR	AR																														
DM	DM	DM																														
HR	HR	HR																														
TC	TC	LR																														
LR	LR	#																														

Name Mnemonic	Symbol	Function	Operands			CPU				
<b>Digital Switch Input</b> DSW(*)	<table border="1"> <tr><td>DSW(-)</td></tr> <tr><td>IW</td></tr> <tr><td>OW</td></tr> <tr><td>R</td></tr> </table>	DSW(-)	IW	OW	R	Inputs 4- or 8- digit BCD data from a digital switch.	<b>IW:</b> IR SR AR HR LR	<b>OW:</b> IR SR AR HR LR	<b>R:</b> IR SR AR DM HR LR	HS-CPU's
DSW(-)										
IW										
OW										
R										
<b>Frame Check Sum</b> FCS(*)	<table border="1"> <tr><td>ECS(-)</td></tr> <tr><td>C</td></tr> <tr><td>R1</td></tr> <tr><td>D</td></tr> </table>	ECS(-)	C	R1	D	Checks for errors in data transmitted by a host link command.	<b>C:</b> IR SR AR DM HR LR	<b>R1:</b> IR SR AR DM HR TC LR	<b>D:</b> IR SR AR DM HR LR	HS-CPU's
ECS(-)										
C										
R1										
D										
<b>Failure Point Detect</b> FPD(*)	<table border="1"> <tr><td>FPD(-)</td></tr> <tr><td>C</td></tr> <tr><td>T</td></tr> <tr><td>D</td></tr> </table>	FPD(-)	C	T	D	Finds errors within an instruction block. Used to monitor the time between the execution of FPD(-) and a diagnostic output. If time exceed T a non-fatal error is generated.	<b>C:</b> #	<b>T:</b> BCD IR SR AR DM HR TC LR #	<b>D:</b> IR AR DM HR LR	HS-CPU's
FPD(-)										
C										
T										
D										
<b>Find Maximum</b> (@)MAX(*)	<table border="1"> <tr><td>MAX(-)</td></tr> <tr><td>C</td></tr> <tr><td>R1</td></tr> <tr><td>D</td></tr> </table>	MAX(-)	C	R1	D	Finds the maximum value in specified data area and outputs that value to another word.	<b>C:</b> IR SR AR DM HR LR	<b>R1:</b> IR SR AR DM HR TC LR	<b>D:</b> IR SR AR DM HR LR	HS-CPU's
MAX(-)										
C										
R1										
D										
<b>Find Minimum</b> (@)MIN(*)	<table border="1"> <tr><td>MIN(-)</td></tr> <tr><td>C</td></tr> <tr><td>R1</td></tr> <tr><td>D</td></tr> </table>	MIN(-)	C	R1	D	Finds the minimum value in specified data area and outputs that value to another word.	<b>C:</b> IR SR AR DM HR LR	<b>R1:</b> IR SR AR DM HR TC LR	<b>D:</b> IR SR AR DM HR LR	HS-CPU's
MIN(-)										
C										
R1										
D										
<b>Matrix Input</b> (@)MTR(*)	<table border="1"> <tr><td>MTR(-)</td></tr> <tr><td>IW</td></tr> <tr><td>OW</td></tr> <tr><td>D</td></tr> </table>	MTR(-)	IW	OW	D	Inputs data from an 8 input point X 8 output point matrix and records that data in D through D+3.	<b>IW:</b> IR SR AR HR LR	<b>OW:</b> IR SR AR HR LR	<b>D:</b> IR AR DM HR LR	HS-CPU's
MTR(-)										
IW										
OW										
D										
<b>PID Control</b> (@)PID(*)	<table border="1"> <tr><td>PID(-)</td></tr> <tr><td>S</td></tr> <tr><td>C</td></tr> <tr><td>D</td></tr> </table>	PID(-)	S	C	D	PID control is performed according to the operand and PID parameters that are present.	<b>S:</b> IR SR AR DM HR LR	<b>C:</b> IR SR DM HR LR	<b>D:</b> IR SR AR DM HR LR	HS-CPU's
PID(-)										
S										
C										
D										
<b>Receive</b> (@)RXD(*)	<table border="1"> <tr><td>RXD(-)</td></tr> <tr><td>D</td></tr> <tr><td>C</td></tr> <tr><td>N</td></tr> </table>	RXD(-)	D	C	N	Receive data via a communications port.	<b>D:</b> IR SR AR DM HR TC LR	<b>C:</b> IR SR AR DM HR TC LR #	<b>N:</b> IR SR AR DM HR TC LR	HS-CPU's
RXD(-)										
D										
C										
N										

Name Mnemonic	Symbol	Function	Operands			CPU				
<b>Scaling</b> (@)SCL(*)	<table border="1"> <tr><td>SCL(-)</td></tr> <tr><td>S</td></tr> <tr><td>P1</td></tr> <tr><td>R</td></tr> </table>	SCL(-)	S	P1	R	Performs a scaling conversion on the calculated value.	<b>S:</b> IR SR AR DM HR TC LR #	<b>P1:</b> IR SR AR DM HR TC LR	<b>R:</b> IR SR AR DM HR LR	HS-CPU's
SCL(-)										
S										
P1										
R										
<b>Data Search</b> (@)SRCH(*)	<table border="1"> <tr><td>SRCH(-)</td></tr> <tr><td>N</td></tr> <tr><td>R1</td></tr> <tr><td>C</td></tr> </table>	SRCH(-)	N	R1	C	Searches the specified range of memory for the specified data. Outputs the word address(es) of words in the range that contain the data.	<b>N:</b> IR SR AR DM HR TC LR #	<b>R1:</b> IR SR AR DM HR TC LR	<b>C:</b> IR SR AR DM HR LR	HS-CPU's
SRCH(-)										
N										
R1										
C										
<b>Sum Calculate</b> (@)SUM(*)	<table border="1"> <tr><td>SUM(-)</td></tr> <tr><td>C</td></tr> <tr><td>R1</td></tr> <tr><td>D</td></tr> </table>	SUM(-)	C	R1	D	Computes the sum of the contents of the words in the specified range of memory.	<b>N:</b> IR SR AR DM HR TC LR #	<b>R1:</b> IR SR AR DM HR TC LR	<b>D:</b> IR SR AR DM HR LR	HS-CPU's
SUM(-)										
C										
R1										
D										
<b>Ten Key Input</b> (@)TKY(*)	<table border="1"> <tr><td>TKY(-)</td></tr> <tr><td>IW*</td></tr> <tr><td>D1</td></tr> <tr><td>D2</td></tr> </table>	TKY(-)	IW*	D1	D2	Inputs 8 digits of BCD data from a 10-key keypad.	<b>IW:</b> IR SR AR HR LR	<b>D1:</b> IR SR AR DM HR LR	<b>D1:</b> IR SR AR DM HR LR	HS-CPU's
TKY(-)										
IW*										
D1										
D2										
<b>Transmit</b> (@)TXD(*)	<table border="1"> <tr><td>TXD(-)</td></tr> <tr><td>S</td></tr> <tr><td>C</td></tr> <tr><td>N</td></tr> </table>	TXD(-)	S	C	N	Sends data via a communications ports.	<b>S:</b> IR SR AR DM HR TC LR	<b>C:</b> IR SR AR DM HR TC LR #	<b>N:</b> IR SR AR DM HR TC LR #	HS-CPU's
TXD(-)										
S										
C										
N										
<b>Expansion DM Read</b> (@)XDMR(*)	<table border="1"> <tr><td>XDMR(-)</td></tr> <tr><td>N</td></tr> <tr><td>S</td></tr> <tr><td>D</td></tr> </table>	XDMR(-)	N	S	D	The contents of the designated number of words of the fixed expansion DM data are read and output to the destination word.	<b>N:</b> IR SR AR DM HR TC LR #	<b>S:</b> IR SR AR DM HR TC LR #	<b>D:</b> IR SR AR DM HR LR	HS-CPU's
XDMR(-)										
N										
S										
D										

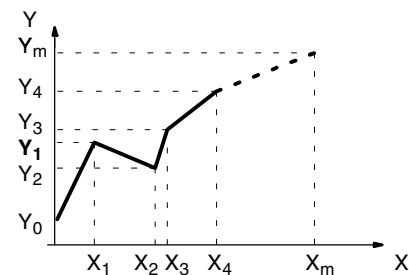
Name Mnemonic	Symbol	Function	Operands			CPU																																																																																										
<b>Value Calculate</b> (@)VCAL(69)	<table border="1" style="width: 100%; border-collapse: collapse;"> <tr><td style="text-align: center;">VCAL(69)</td></tr> <tr><td style="text-align: center;">C</td></tr> <tr><td style="text-align: center;">S</td></tr> <tr><td style="text-align: center;">D</td></tr> </table>	VCAL(69)	C	S	D	<p>Calculates the cosine, or sine of the given degree value, or determines the y-coordinate of the given x value in a previously established line graph. For the sine and cosine conversions, S is entered in BCD as an angle (in the range 0.0 to 90.0 degrees). When calculating the y-coordinate in a graph, S gives the address of the value of the x-coordinate. The calculated data is transferred to the destination word (D). Sine and cosine results are given in BCD. Line graph coordinate calculations (interpolation) can be in BCD or BIN.</p> <p>The data in the control word (C) determines which operation is performed. If C is entered as a constant with a value of 0000 or 0001, the sine or cosine, respectively, of the source data value is calculated. If C is entered as a word designation, it gives the address of the first word of the data table for the line graph. The value of the first two digits gives m-1, where m is the number of data points for which coordinates are given on the line graph. Bits 14 and 15, respectively, specify the output and input data formats (0 indicates BCD, 1 indicates binary).</p>	<table border="0" style="width: 100%;"> <tr> <td style="vertical-align: top; width: 33%;"> <b>C:</b>                      IR                      SR                      HR                      AR                      LR                      TC                      DM                      #                 </td> <td style="vertical-align: top; width: 33%;"> <b>S:</b>                      IR                      SR                      HR                      AR                      LR                      TC                      DM                 </td> <td style="vertical-align: top; width: 33%;"> <b>D:</b>                      IR                      SR                      HR                      AR                      LR                      TC                      DM                 </td> </tr> </table>	<b>C:</b> IR SR HR AR LR TC DM #	<b>S:</b> IR SR HR AR LR TC DM	<b>D:</b> IR SR HR AR LR TC DM	CPU21 CPU23 CPU31																																																																																					
VCAL(69)																																																																																																
C																																																																																																
S																																																																																																
D																																																																																																
<b>C:</b> IR SR HR AR LR TC DM #	<b>S:</b> IR SR HR AR LR TC DM	<b>D:</b> IR SR HR AR LR TC DM																																																																																														
<b>Arithmetic Process</b> (@)APR(*)	<table border="1" style="width: 100%; border-collapse: collapse;"> <tr><td style="text-align: center;">APR(-)</td></tr> <tr><td style="text-align: center;">C</td></tr> <tr><td style="text-align: center;">S</td></tr> <tr><td style="text-align: center;">D</td></tr> </table>	APR(-)	C	S	D	<div style="text-align: center;">  </div> <p style="text-align: center;">Output data format      m-1, where m is the number of data points whose coordinates are specified in the table</p> <p style="text-align: center;">Input data format</p> <table border="1" style="width: 100%; border-collapse: collapse; margin-top: 10px;"> <tr> <td style="width: 10%;"></td> <td style="width: 10%; text-align: center;">15</td> <td style="width: 10%; text-align: center;">14</td> <td style="width: 10%; text-align: center;">-----</td> <td style="width: 10%; text-align: center;">08</td> <td style="width: 10%; text-align: center;">07</td> <td style="width: 10%; text-align: center;">-----</td> <td style="width: 10%; text-align: center;">00</td> </tr> <tr> <td style="text-align: right;">C</td> <td colspan="7" style="text-align: center;">000000</td> </tr> <tr> <td style="text-align: right;">C+1</td> <td colspan="7" style="text-align: center;">X<sub>m</sub> (max. x-coordinate for this table)</td> </tr> <tr> <td style="text-align: right;">C+2</td> <td colspan="7" style="text-align: center;">Y<sub>0</sub></td> </tr> <tr> <td style="text-align: right;">C+3</td> <td style="text-align: center;">X<sub>1</sub></td> <td style="text-align: center;">-</td> <td style="text-align: center;">-</td> <td style="text-align: center;">-</td> <td style="text-align: center;">-</td> <td style="text-align: center;">-</td> <td style="text-align: center;">-</td> </tr> <tr> <td style="text-align: right;">C+4</td> <td style="text-align: center;">Y<sub>1</sub></td> <td style="text-align: center;">-</td> <td style="text-align: center;">-</td> <td style="text-align: center;">-</td> <td style="text-align: center;">-</td> <td style="text-align: center;">-</td> <td style="text-align: center;">-</td> </tr> <tr> <td style="text-align: right;">C+5</td> <td style="text-align: center;">X<sub>2</sub></td> <td style="text-align: center;">-</td> <td style="text-align: center;">-</td> <td style="text-align: center;">-</td> <td style="text-align: center;">-</td> <td style="text-align: center;">-</td> <td style="text-align: center;">-</td> </tr> <tr> <td style="text-align: right;">C+6</td> <td style="text-align: center;">Y<sub>2</sub></td> <td style="text-align: center;">-</td> <td style="text-align: center;">-</td> <td style="text-align: center;">-</td> <td style="text-align: center;">-</td> <td style="text-align: center;">-</td> <td style="text-align: center;">-</td> </tr> <tr> <td style="text-align: right;">⋮</td> <td style="text-align: center;">-</td> <td style="text-align: center;">-</td> <td style="text-align: center;">-</td> <td style="text-align: center;">-</td> <td style="text-align: center;">-</td> <td style="text-align: center;">-</td> <td style="text-align: center;">-</td> </tr> <tr> <td style="text-align: right;">C+(2m+1)</td> <td style="text-align: center;">X<sub>m</sub></td> <td style="text-align: center;">-</td> <td style="text-align: center;">-</td> <td style="text-align: center;">-</td> <td style="text-align: center;">-</td> <td style="text-align: center;">-</td> <td style="text-align: center;">-</td> </tr> <tr> <td style="text-align: right;">C+(2m+2)</td> <td style="text-align: center;">Y<sub>m</sub></td> <td style="text-align: center;">-</td> <td style="text-align: center;">-</td> <td style="text-align: center;">-</td> <td style="text-align: center;">-</td> <td style="text-align: center;">-</td> <td style="text-align: center;">-</td> </tr> </table>		15	14	-----	08	07	-----	00	C	000000							C+1	X <sub>m</sub> (max. x-coordinate for this table)							C+2	Y <sub>0</sub>							C+3	X <sub>1</sub>	-	-	-	-	-	-	C+4	Y <sub>1</sub>	-	-	-	-	-	-	C+5	X <sub>2</sub>	-	-	-	-	-	-	C+6	Y <sub>2</sub>	-	-	-	-	-	-	⋮	-	-	-	-	-	-	-	C+(2m+1)	X <sub>m</sub>	-	-	-	-	-	-	C+(2m+2)	Y <sub>m</sub>	-	-	-	-	-	-		HS-CPU's
APR(-)																																																																																																
C																																																																																																
S																																																																																																
D																																																																																																
	15	14	-----	08	07	-----	00																																																																																									
C	000000																																																																																															
C+1	X <sub>m</sub> (max. x-coordinate for this table)																																																																																															
C+2	Y <sub>0</sub>																																																																																															
C+3	X <sub>1</sub>	-	-	-	-	-	-																																																																																									
C+4	Y <sub>1</sub>	-	-	-	-	-	-																																																																																									
C+5	X <sub>2</sub>	-	-	-	-	-	-																																																																																									
C+6	Y <sub>2</sub>	-	-	-	-	-	-																																																																																									
⋮	-	-	-	-	-	-	-																																																																																									
C+(2m+1)	X <sub>m</sub>	-	-	-	-	-	-																																																																																									
C+(2m+2)	Y <sub>m</sub>	-	-	-	-	-	-																																																																																									

Name Mnemonic	Symbol	Function	Operands	CPU																															
<b>SYSMAC NET</b> <b>SYSMAC LINK</b> <b>Write</b> (@)SEND(90)	SEND(90)	<p>Transfers data from n source words (S is the starting word) to the destination words (D is the first address) in node N of the specified network (in a SYSMAC LINK or SYSMAC NET System). The format of the control words varies depending on the type of system. In both types of systems, the first control word (C) gives the number of words to be transferred.</p> <p>For SYSMAC NET Systems, in word C+1, bit 14 specifies the system (0 for system 1, and 1 for system 0), and the rightmost 7 bits define the network number. The left half of word C+2 specifies the destination port (00: NSB, 01/02: NSU), and the right half specifies the destination node number. If the destination node number is set to 0, data is transmitted to all nodes.</p> <p>For SYSMAC LINK Systems, the right half of C+1 specifies the response monitoring time (default 00: 2 s, FF: monitoring disabled), the next digit to the left gives the maximum number of re-transmissions (0 to 15) that the PC will attempt if no response signal is received. Bit 13 specifies whether a response is needed (0) or not (1), and bit 14 specifies the system number (0 for system 1, and 1 for system 0). The right half of C+2 gives the destination node number. If this is set to 0, the data will be sent to all nodes.</p> <p>SYSMAC NET</p> <table border="1"> <tr> <td>C</td> <td colspan="3">n: no. of words to be transmitted (0 to 1000)</td> </tr> <tr> <td>C+1</td> <td>0X00</td> <td>0000</td> <td>Network no. (0 to 127)</td> </tr> <tr> <td>C+2</td> <td colspan="2">Destination port no.</td> <td>Destination node no. (0 to 126)</td> </tr> </table> <p>SYSMAC LINK</p> <table border="1"> <tr> <td>C</td> <td colspan="3">n: no. of words to be transmitted, 0 to 1000</td> </tr> <tr> <td>C+1</td> <td>0XX0</td> <td>Re-transmissions</td> <td>Response monitor time (0.1 to 25.4 s)</td> </tr> <tr> <td>C+2</td> <td>0000</td> <td>0000</td> <td>Destination node no. (0 to 62)</td> </tr> </table> <p>Source node N</p> <table border="1"> <tr><td>S</td></tr> <tr><td>S+1</td></tr> <tr><td>S+n-1</td></tr> </table> <p>→</p> <p>Destination node</p> <table border="1"> <tr><td>D</td></tr> <tr><td>D+1</td></tr> <tr><td>D+n-1</td></tr> </table>	C	n: no. of words to be transmitted (0 to 1000)			C+1	0X00	0000	Network no. (0 to 127)	C+2	Destination port no.		Destination node no. (0 to 126)	C	n: no. of words to be transmitted, 0 to 1000			C+1	0XX0	Re-transmissions	Response monitor time (0.1 to 25.4 s)	C+2	0000	0000	Destination node no. (0 to 62)	S	S+1	S+n-1	D	D+1	D+n-1	<b>S:</b> IR SR HR AR TC DM LR	<b>D/C:</b> IR HR AR TC DM LR	CPU31 HS-CPU31 HS-CPU33
	C		n: no. of words to be transmitted (0 to 1000)																																
	C+1		0X00	0000	Network no. (0 to 127)																														
	C+2		Destination port no.		Destination node no. (0 to 126)																														
C	n: no. of words to be transmitted, 0 to 1000																																		
C+1	0XX0	Re-transmissions	Response monitor time (0.1 to 25.4 s)																																
C+2	0000	0000	Destination node no. (0 to 62)																																
S																																			
S+1																																			
S+n-1																																			
D																																			
D+1																																			
D+n-1																																			

Name Mnemonic	Symbol	Function	Operands	CPU																																					
<b>SYSMAC NET</b> <b>SYSMAC LINK</b> <b>Read</b> (@)RECV(98)	<table border="1"> <tr><td>RECV(98)</td></tr> <tr><td>S</td></tr> <tr><td>D</td></tr> <tr><td>C</td></tr> </table>	RECV(98)	S	D	C	<p>Transfers data from the source words (S is the first word) from node N of the specified network (in a SYSMAC LINK or SYSMAC NET System) to the destination words starting at D. The format of the control words varies depending on the type of system. In both types of systems, the first control word (C) gives the number of words to be transferred.</p> <p>For SYSMAC NET Systems, in the second word (C+1), bit 14 specifies the system (0 for system 1, and 1 for system 0), and the rightmost 7 bits define the network number. The left half of word C+2 specifies the source port (00: NSB, 01/02: NSU), and the right half specifies the source node number. For SYSMAC LINK Systems, the right half of C+1 specifies the response monitoring time (default 00: 2 s, FF: monitoring disabled), the next digit to the left gives the maximum number of re-transmissions (0 to 15) that the PC will attempt if no response signal is received. Bit 13 specifies whether a response is needed (0) or not (1), and bit 14 specifies the system number (0 for system 1, and 1 for system 0). The right half of C+2 gives the source node number.</p> <p>SYSMAC NET</p> <table border="1"> <tr> <td>C</td> <td colspan="3">n: no. of words to be transmitted (0 to 1000)</td> </tr> <tr> <td>C+1</td> <td>0X00</td> <td>0000</td> <td>Network no. (0 to 127)</td> </tr> <tr> <td>C+2</td> <td colspan="2">Source port no. (NSB: 00, NSU: 01/02)</td> <td>Source node no. (0 to 126)</td> </tr> </table> <p>SYSMAC LINK</p> <table border="1"> <tr> <td>C</td> <td colspan="3">n: no. of words to be transmitted, 0 to 1000</td> </tr> <tr> <td>C+1</td> <td>0XX0</td> <td>Re-transmissions</td> <td>Response monitor time (0.1 to 25.4 s)</td> </tr> <tr> <td>C+2</td> <td>0000</td> <td>0000</td> <td>Source node no. (0 to 62)</td> </tr> </table> <p>Source node N</p> <table border="1"> <tr><td>S</td></tr> <tr><td>S+1</td></tr> <tr><td>...</td></tr> <tr><td>S+n-1</td></tr> </table> <p>→</p> <p>Destination node</p> <table border="1"> <tr><td>D</td></tr> <tr><td>D+1</td></tr> <tr><td>...</td></tr> <tr><td>D+n-1</td></tr> </table>	C	n: no. of words to be transmitted (0 to 1000)			C+1	0X00	0000	Network no. (0 to 127)	C+2	Source port no. (NSB: 00, NSU: 01/02)		Source node no. (0 to 126)	C	n: no. of words to be transmitted, 0 to 1000			C+1	0XX0	Re-transmissions	Response monitor time (0.1 to 25.4 s)	C+2	0000	0000	Source node no. (0 to 62)	S	S+1	...	S+n-1	D	D+1	...	D+n-1	<b>S:</b> IR SR HR AR TC DM LR	<b>D/C:</b> IR HR AR TC DM LR	CPU31 HS-CPU31 HS-CPU33
RECV(98)																																									
S																																									
D																																									
C																																									
C	n: no. of words to be transmitted (0 to 1000)																																								
C+1	0X00	0000	Network no. (0 to 127)																																						
C+2	Source port no. (NSB: 00, NSU: 01/02)		Source node no. (0 to 126)																																						
C	n: no. of words to be transmitted, 0 to 1000																																								
C+1	0XX0	Re-transmissions	Response monitor time (0.1 to 25.4 s)																																						
C+2	0000	0000	Source node no. (0 to 62)																																						
S																																									
S+1																																									
...																																									
S+n-1																																									
D																																									
D+1																																									
...																																									
D+n-1																																									



**NOTE: DIMENSIONS SHOWN ARE IN MILLIMETERS. To convert millimeters to inches divide by 25.4.**

---

**OMRON**<sup>®</sup>  
**OMRON ELECTRONICS, INC.**  
One East Commerce Drive  
Schaumburg, IL 60173  
**1-800-55-OMRON**

**OMRON CANADA, INC.**  
885 Milner Avenue  
Scarborough, Ontario M1B 5V8  
**416-286-6465**