

THIS DOCUMENT IS THE PROPERTY OF KEYSTONE ELECTRONICS CORP. AND SHALL NOT BE REPRODUCED, DISTRIBUTED OR USED AS A BASIS FOR MANUFACTURE WITHOUT PRIOR WRITTEN PERMISSION FROM KEYSTONE ELECTRONICS CORP.

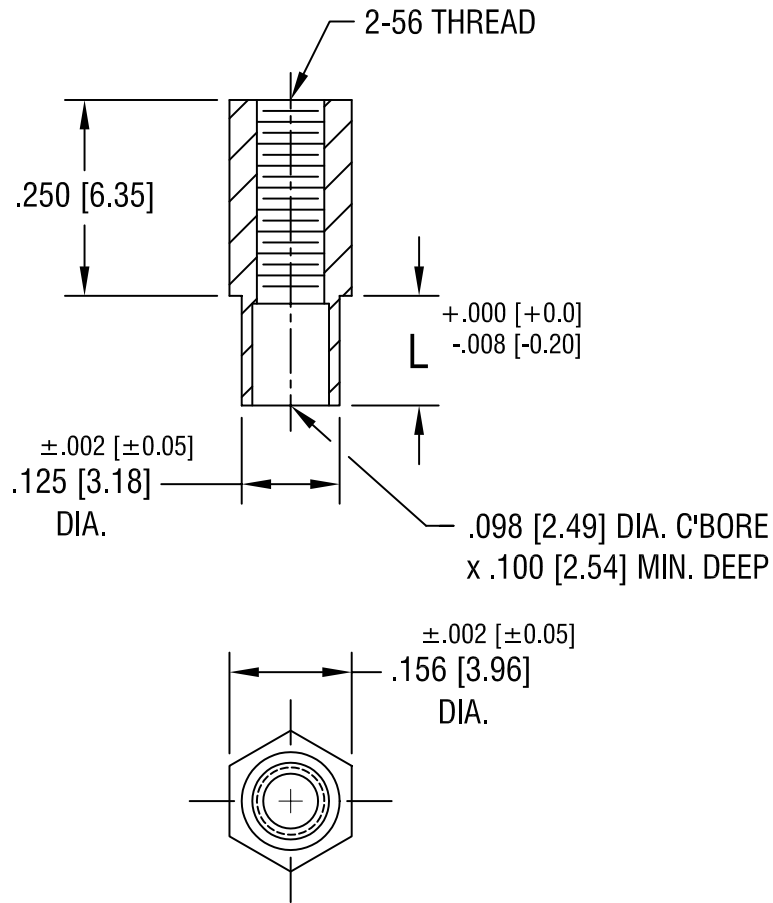

PART NO.	'L' DIM.
1740-2	.109 [2.77]
1740-3	.140 [3.56]

KEYSTONE ELECTRONICS CORP.			
ASTORIA, N.Y. 11105-2017			
PART NAME SWAGE THREADED STANDOFF			
MATERIAL BRASS			
FINISH DUCTILE NICKEL PLATE		DRN BY BOONE	DATE 3.12.98
		APP'D	SCALE 4X
TOLERANCES INCH [MM]		CODE	DWG NO.
DECIMAL ± .005 [± 0.15]		C/M	1740-
ANGULAR ± 1° UNLESS OTHERWISE SPECIFIED			

5.10.02	CHANGE AS PER ECN 02-036	A
DATE	DESCRIPTION	REV.