

Please note that the data given here has been taken from the online catalog. For comprehensive information and data, please refer to the user documentation at <http://www.download.phoenixcontact.com>. The General Terms and Conditions of Use apply to Internet downloads.

## ► Extract from the online catalog



FO converter with integrated optical diagnosis, alarm contact, for Profibus up to 12 Mbit/s, terminal equipment with an FO interface (BFOC), 850 nm, for fiber glass cable

Order No.	2708274
Ord designation	PSI-MOS-PROFIB/FO 850 E
EAN	4017918973971
Pack	1 Pcs.
Customs tariff	85176200
Weight/Piece	0.2307 KG
Catalog page information	Page 435 (IF-2007)

## ► Product notes

WEEE/RoHS-compliant since: 07/04/2007



**IMPORTANT :** This date is valid for Customers in Germany only. Date Format is MM/DD/YYYY. Please contact your local in-country Phoenix Contact location or designated business partner for a Logistics Compliant date in your area. In order to guarantee delivery of RoHS-Compliant product, please purchase Phoenix Contact parts from authorized Phoenix Contact representatives and distributors.

---

▶ **Technical data**

---

---

**Serial interface**

Interface 1	PROFIBUS acc. to IEC 61158, RS-485 2-wire, half-duplex, automatic control
Operating mode	Semi-duplex
File format/coding	UART (11 Bit, NRZ)
Data direction switching	Automatic control
Data rate	9,6/19,2/45,45/93,75/187,5/500/1500/3000/6000/12000 kBit/s, automatische Erkennung, optional Einstellung über DIP-Schalter
Transmission length	Max. 1200 m (With shielded, twisted-pair data line depending on the data rate )
Type of connection	D-SUB-9 female connector
Serial transmission rate	9.6/19.2/45.45/93.75/187.5/500/1500/3000/6000/12000 kbps, automatic detection, optional setting using a DIP switch

---

**Optical interface FO**

Transmit capacity, minimum	-4.2 dBm (200/230 µm)
Transmit capacity, minimum	-17.8 dBm (50/125 µm)
Transmit capacity, minimum	-14.6 dBm (62,5/125 µm)
Minimum receiver sensitivity	-30.00 dBm (50/125 µm)
Maximum receiver sensitivity	-3 dBm (200/230 µm)
Wave length	850 nm
Transmission length incl. 3 dB system reserve	Min. 800 m (with F-S 200/230 10 dB/km with quick mounting plug)
Transmission length incl. 3 dB system reserve	Min. 2600 m (with F-G 50/125 2.5 dB/km)
Transmission length incl. 3 dB system reserve	Min. 3300 m (with F-G 62,5/125 3.0 dB/km)
Transmission protocol	Transparent to protocol to the RS-485 interface
Type of connection	B-FOC

---

**Fault warning output**

Maximum switching voltage	60 V DC
Maximum switching voltage	42 V AC
Limiting continuous current	1 A

---

**Power supply**

Nominal supply voltage	24 V DC ± 25%
Range of supply voltages	18 V DC ... 32 V DC
Typical current consumption	100 mA
Type of connection	Pluggable COMBICON screw terminal block

---

**General data**

Bit delay	≤ 1 Bit
Bit distortion, input	± 35 % (permitted)
Bit distortion output	< 6.25 %
Length	99 mm
Height	105 mm
Width	35 mm
Ambient temperature (storage/transport)	-40 °C ... 85 °C
Ambient temperature (operation)	-20 °C ... 60 °C
Electrical isolation	RS-485 // supply

---

Electromagnetic compatibility	Conformance with EMC directive 89/336/EEC
Emitted interference	EN 55011
Immunity to interference	EN 61000-6-2
Degree of protection	IP20
Housing material	PA V0, color green
Color	green
MTBF	453000 h in accordance with the Telcordia standard (ambient temperature 25°C)
MTBF	236000 h in accordance with the Telcordia standard (ambient temperature 40°C)



► Drawings

Application drawing

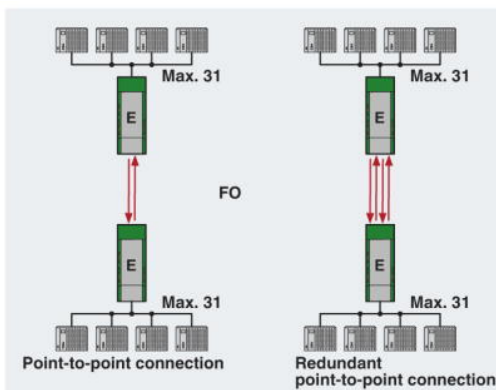
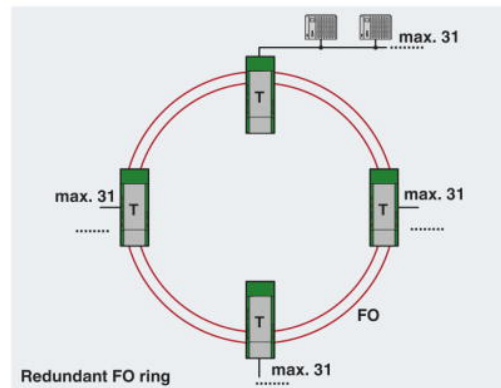
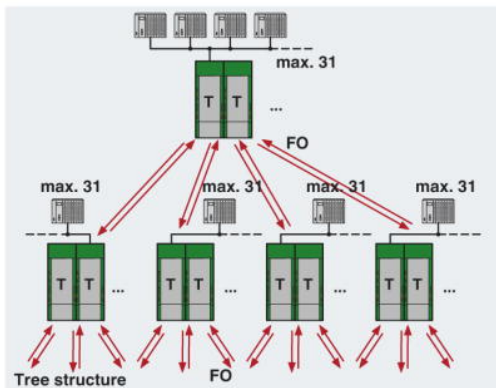
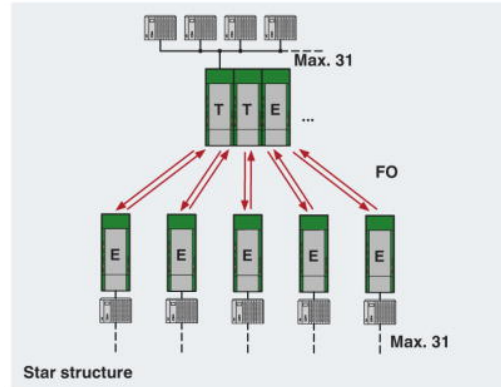
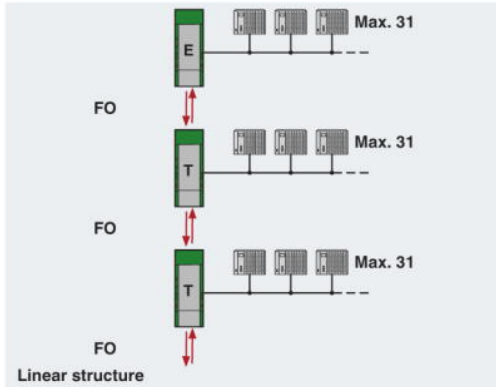

Block diagram

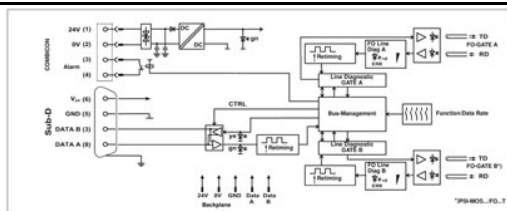

\*) only with PSI-MOS.../FO...T

Logo

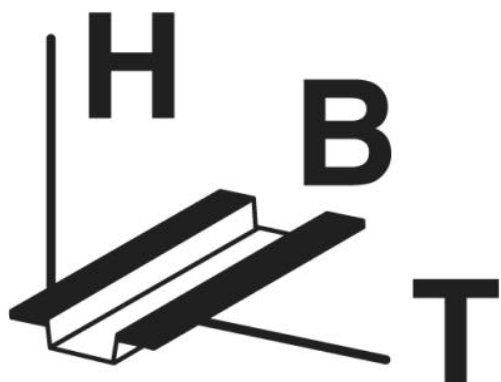



## ► Accessories

Item	Designation	Description
<b>Cable/conductor</b>		
2744652	PSM-CABLE-PROFIB/FC	PROFIBUS cable, Fast Connect type, up to 12 Mbit/s (02YSY (ST)CY 1x2x22 AWG)
2799885	PSM-LWL-HCS-RUGGED-200/230	HCS cable, duplex 200/230 µm, by the meter, without connector, for indoor installation
2799445	PSM-LWL-HCSO-200/230	HCS cable, duplex 200/230 µm, by the meter, without connector, for outdoor installation
2744937	PSM-LWL/HCS-RUGGED	HCS cable, duplex 200/230 µm, by the meter, with connector, for indoor installation
2744940	PSM-LWL/HCSO	HCS cable, duplex 200/230 µm, by the meter, with connector, for outdoor installation
<b>General</b>		
2709561	ME 17,5 TBUS 1,5/ 5-ST-3,81 GN	Bus connector, gold-plated contacts, for mounting on DIN rail, 5-pos.
2890014	ME 17,5 TBUS 1,5/PP000-3,81 BK	DIN rail connector (optional) for routing through the supply voltage
2866983	MINI-SYS-PS-100-240AC/24DC/1.5	Power supply unit, primary switched-mode, narrow design, output: 24 V DC / 1.5 A
2708863	PSI-REP-PROFIBUS/12MB	Modular repeater for electrical isolation and range increase for PROFIBUS up to 12 mbps, 4-way isolation, rail-mountable, supply 24 V DC
2760623	PSM PTK	Passive RS-485 T-distributor, fitted with one 9-pin SUB-D pin strip and two 9-pin SUB-D socket strips
2799364	PSM PTK-4	Passive RS-485 T-distributor, fitted with one 9-pin SUB-D pin strip and five 9-pin SUB-D socket strips
2708465	PSM-HCS-KONFTOOL/B-FOC	HCS DIY case for B-FOC(ST) quick mounting connector, including four B-FOC(ST) quick mounting connectors, stripping knife, stripping pliers, aramide yarn scissors, fiber stripper, fiber cleaving tool and microscope
2799322	PSM-LWL-GDM-RUGGED-50/125	Glass fiber cable, duplex 50/125 µm, by the meter, without connector, for indoor installation
2799432	PSM-LWL-GDO-50/125	Glass fiber cable, duplex 50/125 µm, by the meter, without connector, for outdoor installation
2744911	PSM-LWL/GDM-RUGGED	Glass fiber cable, duplex 50/125 µm, by the meter, with connector, for indoor installation
2744924	PSM-LWL/GDO	Glass fiber cable, duplex 50/125 µm, by the meter, with connector, for outdoor installation
2744429	PSM-ME-RS485/RS485-P	Repeater, for potential separation and range increase in RS-485 2-wire bus systems, 3-way isolation, rail-mountable
<b>Plug/Adapter</b>		
2799429	PSM-SET-BFOC-LINK/2	Coupling; set consisting of 2 couplings for connecting B-FOC plugs
2799487	PSM-SET-FSMA/4-HCS	F-SMA plug set for HCS fiber, for self assembly consisting of 4 quick mounting connectors with bend protection sleeve

## PSI-MOS-PROFIB/FO 850 E



---

2744380	SUBCON-PLUS-PROFIB/AX/SC	PROFIBUS connector up to 12 Mbit/s, axial version, integrated terminating resistor that can be connected externally, connection system: Screw connection
2708245	SUBCON-PLUS-PROFIB/PG/SC2	Small, angled Profibus connector with screw connection and additional Pg connection
2708232	SUBCON-PLUS-PROFIB/SC2	Small, angled Profibus connector with screw connection

**Tools**

2799539	PSM-FO-POWERMETER	Fiber optic measuring case, consisting of an optical power meter, F-SMA, B-FOC adapters, reference fibers and operating instructions
2744623	PSM-STRIP-FC/PROFIB	Quick stripping tool for Profibus cable, type Fast Connect
1205037	SZS 0,4X2,5	Screwdriver, bladed, matches all screw terminal blocks up to 1.5 mm <sup>2</sup> connection cross section, blade: 0.4 x 2.5 mm

---

---

## ► Address

---

PHOENIX CONTACT GmbH & Co. KG  
Flachsmarktstr. 8  
32825 Blomberg  
Germany  
Phone +49 5235 3 00  
Fax +49 5235 3 41200  
<http://www.phoenixcontact.de>  
Phoenix Contact  
Technical modifications reserved;