

DFK-PCV 5/ 3-GF-7,62

Order No.: 1716409

The figure shows a 5-pos. version of the product

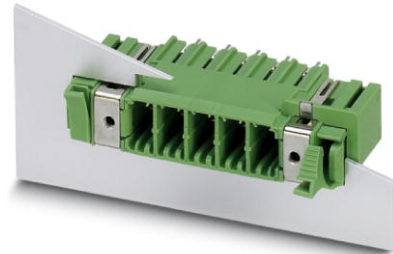

<http://eshop.phoenixcontact.de/phoenix/treeViewClick.do?UID=1716409>

Header, Nominal current: 41 A, Rated voltage (III/2): 630 V, Number of positions: 3, Pitch: 7.62 mm, Color: green, Assembly: Soldering

Commercial data	
GTIN (EAN)	 4 046356 137027
Note	Made-to-order
sales group	E523
Pack	10 pcs.
Customs tariff	85366990
Catalog page information	Page 453 (CC-2011)

Product notes

WEEE/RoHS-compliant since:
04/18/2006



<http://www.download.phoenixcontact.com>
Please note that the data given here has been taken from the online catalog. For comprehensive information and data, please refer to the user documentation. The General Terms and Conditions of Use apply to Internet downloads.

Technical data

Dimensions / positions	
Length	19.54 mm
Pitch	7.62 mm
Dimension a	15.24 mm
Number of positions	3
Pin dimensions	0,8 x 1,0

Pin spacing	7.62 mm
Hole diameter	1.3 mm

Technical data

Range of articles	DFK-PCV 5/...-GF
Insulating material group	I
Rated surge voltage (III/3)	6 kV
Rated surge voltage (III/2)	6 kV
Rated surge voltage (II/2)	6 kV
Rated voltage (III/2)	630 V
Rated voltage (II/2)	800 V
Connection in acc. with standard	EN-VDE
Nominal current I_N	41 A
Nominal voltage U_N	500 V
Maximum load current	41 A
Insulating material	PA
Inflammability class acc. to UL 94	V0
Color	Green

Diagrams/Drawings

Drilling plan/solder pad geometry

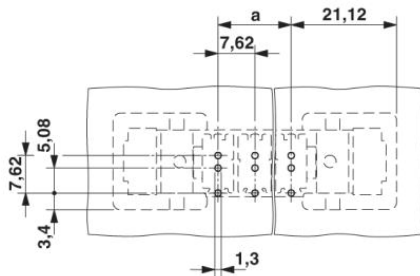

Dimensioned drawing

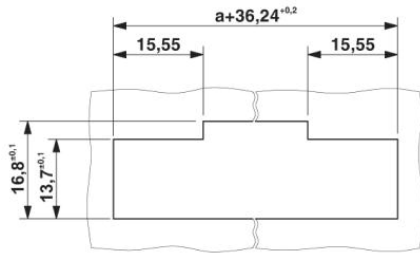

Sheet metal cutout for snap-on.

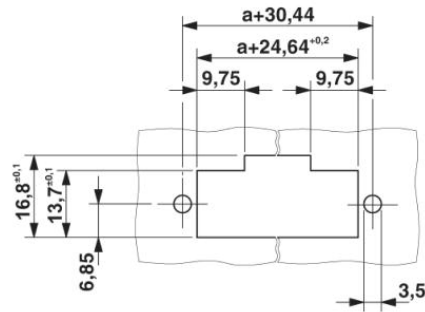

Sheet metal cutout for screw connection.

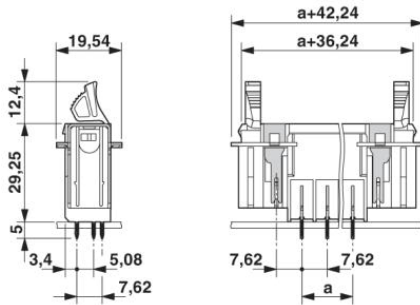

Address

PHOENIX CONTACT Inc., USA
586 Fulling Mill Road
Middletown, PA 17057, USA
Phone (800) 888-7388
Fax (717) 944-1625
<http://www.phoenixcon.com>



© 2011 Phoenix Contact
Technical modifications reserved;