

EMSTB 2,5/ 5-GF-5,08

Order No.: 1899647

The figure shows a 10-position version of the product

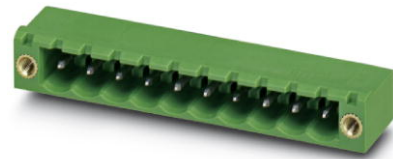

<http://eshop.phoenixcontact.de/phoenix/treeViewClick.do?UID=1899647>

Header, Nominal current: 12 A, Rated voltage (III/2): 320 V, Number of positions: 5, Pitch: 5.08 mm, Color: green, Assembly: Press-in

Commercial data	
GTIN (EAN)	 4 017918 170400
Note	Made-to-order
sales group	E115
Pack	50 pcs.
Customs tariff	85366990
Catalog page information	Page 285 (CC-2011)

Product notes

WEEE/RoHS-compliant since:
01/01/2003



<http://www.download.phoenixcontact.com>
Please note that the data given here has been taken from the online catalog. For comprehensive information and data, please refer to the user documentation. The General Terms and Conditions of Use apply to Internet downloads.

Technical data

Dimensions / positions	
Length	12 mm
Pitch	5.08 mm
Dimension a	20.32 mm
Number of positions	5
Pin dimensions	1,7 mm

Hole diameter	1.75 mm
Technical data	
Range of articles	EMSTB 2,5/..-GF
Insulating material group	IIIa
Rated surge voltage (III/3)	4 kV
Rated surge voltage (III/2)	4 kV
Rated surge voltage (II/2)	4 kV
Rated voltage (III/2)	320 V
Rated voltage (II/2)	400 V
Connection in acc. with standard	EN-VDE
Nominal current I_N	12 A
Nominal voltage U_N	250 V
Maximum load current	12 A
Insulating material	PBT
Inflammability class acc. to UL 94	V0
Color	Green
Nominal voltage, UL/CUL Use Group B	250 V
Nominal current, UL/CUL Use Group B	12 A
Nominal voltage, UL/CUL Use Group D	300 V
Nominal current, UL/CUL Use Group D	10 A

Certificates / Approvals



Certification

CB, CUL, GOST, UL, VDE-PZI

Accessories

Item	Designation	Description
Assembly		
1877203	EMSTB 2,5-SH	Stamp holder, for upper and lower stamp
1877216	EMSTBVA 2,5-SS-1-5,08	Stamp set, consisting of an upper and lower stamp, upper stamp: 2 to 16-pos., lower stamp: 2 to 24-pos., pitch: 5.08 mm

1877229	EMSTBVA 2,5-SS-2-5,08	Stamp set, consisting of an upper and lower stamp, upper stamp: 17 to 24-pos., lower stamp: 2 to 24-pos., pitch: 5.08 mm
1755477	MSTB-BL	Keying cap, for forming sections, plugs onto header pin, green insulating material

Marking

0804293	SK 5,08/3,8:FORTL.ZAHLEN	Marker card, printed horizontally, self-adhesive, 12 identical decades marked 1-10, 11-20 etc. up to 91-(99)100, sufficient for 120 terminal blocks
---------	--------------------------	---

Plug/Adapter

1734401	CR-MSTB	Coding section, inserted into the recess in the header or the inverted plug, red insulating material
---------	---------	--

Additional products

Item	Designation	Description
General		
1873236	FKC 2,5/ 5-STF-5,08	Plug component, Nominal current: 12 A, Rated voltage (III/2): 320 V, Number of positions: 5, Pitch: 5.08 mm, Connection method: Spring-cage conn., Color: green
1902330	FKCT 2,5/ 5-STF-5,08	Plug component, Nominal current: 12 A, Rated voltage (III/2): 320 V, Number of positions: 5, Pitch: 5.08 mm, Connection method: Spring-cage conn., Color: green
1874138	FKCVR 2,5/ 5-STF-5,08	Plug component, Nominal current: 12 A, Rated voltage (III/2): 320 V, Number of positions: 5, Pitch: 5.08 mm, Connection method: Spring-cage conn., Color: green
1873838	FKCVW 2,5/ 5-STF-5,08	Plug component, Nominal current: 12 A, Rated voltage (III/2): 320 V, Number of positions: 5, Pitch: 5.08 mm, Connection method: Spring-cage conn., Color: green
1777837	FRONT-MSTB 2,5/ 5-STF-5,08	Plug component, Nominal current: 12 A, Rated voltage (III/2): 320 V, Number of positions: 5, Pitch: 5.08 mm, Connection method: Screw connection, Color: green
1778014	MSTB 2,5/ 5-STF-5,08	Plug component, Nominal current: 12 A, Rated voltage (III/2): 320 V, Number of positions: 5, Pitch: 5.08 mm, Connection method: Screw connection, Color: green
1809763	MSTBC 2,5/ 5-STZF-5,08	Plug component, Nominal current: 12 A, Rated voltage (III/2): 320 V, Number of positions: 5, Pitch: 5.08 mm, Connection method: Crimp connection, Color: green, Corresponding female crimp contacts with current [A] and conductor cross section range [mm ²] data: 10A/MSTBC-MT 0,5-1,0 (3190564); 10A/MSTBC-MT 0,5-1,0 BA (3190645); 12A/MSTBC-MT 1,5-2,5 (3190551); 12A/MSTBC-MT 1,5-2,5 BA (3190658). BA = Bandkontakte
1805330	MSTBT 2,5/ 5-STF-5,08	Plug component, Nominal current: 12 A, Rated voltage (III/2): 320 V, Number of positions: 5, Pitch: 5.08 mm, Connection method: Screw connection, Color: green

1835122	MVSTBR 2,5/ 5-STF-5,08	Plug component, Nominal current: 12 A, Rated voltage (III/2): 320 V, Number of positions: 5, Pitch: 5.08 mm, Connection method: Screw connection, Color: green
1834932	MVSTBW 2,5/ 5-STF-5,08	Plug component, Nominal current: 12 A, Rated voltage (III/2): 320 V, Number of positions: 5, Pitch: 5.08 mm, Connection method: Screw connection, Color: green
1883381	QC 1/ 5-STF-5,08	Plug component, Nominal current: 10 A, Rated voltage (III/2): 630 V, Number of positions: 5, Pitch: 5.08 mm, Connection method: Insulation displacement connection QUICKON, Color: green
1853133	TMSTBP 2,5/ 5-STF-5,08	Plug component, Nominal current: 12 A, Rated voltage (III/2): 320 V, Number of positions: 5, Pitch: 5.08 mm, Connection method: Screw connection, Color: green, The plug allows conductors to be looped through from module to module.

Diagrams/Drawings

Drilling plan/solder pad geometry

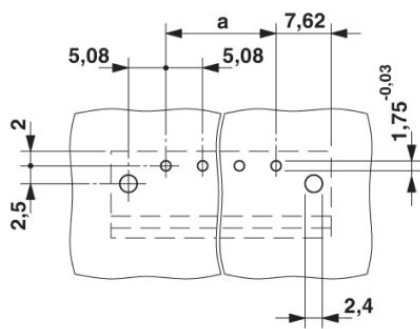

Bore hole in the basic material, mostly epoxy glass fabric FR4 or EP-GC

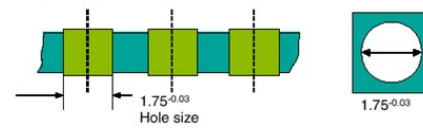

Bore hole with Cu ferrule

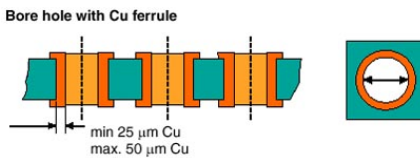

Plated-through bore hole with Sn/SnPb

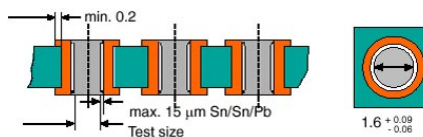

Diagram

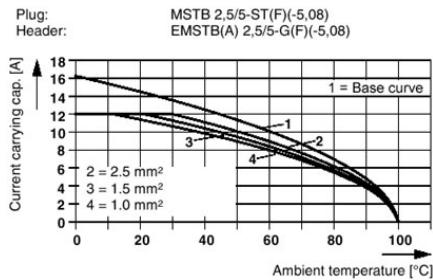

Dimensioned drawing

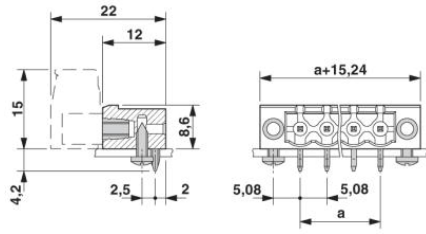

Address

PHOENIX CONTACT Inc., USA
586 Fulling Mill Road
Middletown, PA 17057, USA
Phone (800) 888-7388
Fax (717) 944-1625
<http://www.phoenixcon.com>



© 2011 Phoenix Contact
Technical modifications reserved;