

	TYPE <b>PRODUCT SPECIFICATION</b>	NUMBER <b>GS-12-083</b>	
TITLE <b>Single and Multi-Port Jack Assemblies</b>		PAGE <b>1 of 26</b>	REVISION <b>J</b>
		AUTHORIZED BY <b>J.R. VOLSTORF</b>	DATE <b>7-Jun-06</b>
		STATUS <b>UNRESTRICTED</b>	

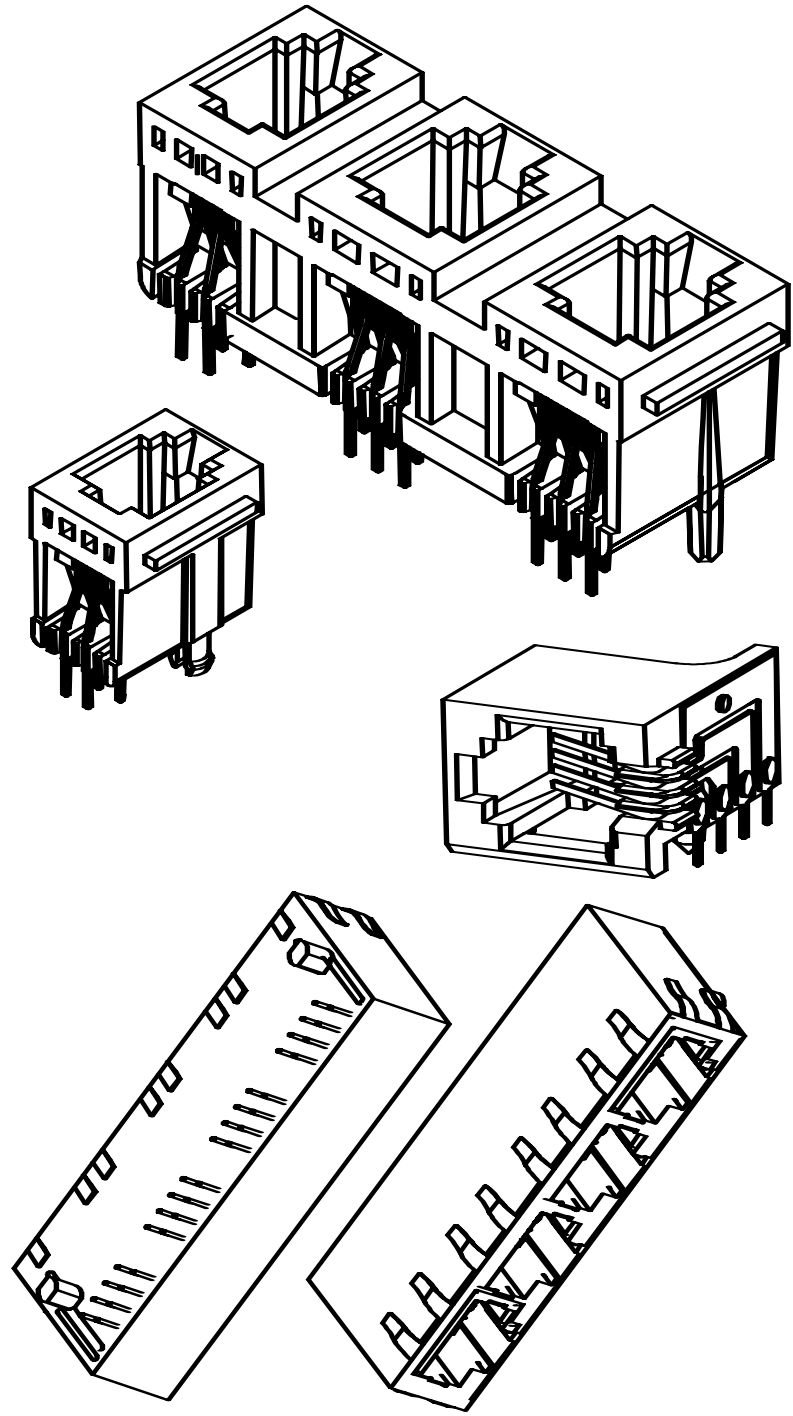

	TYPE	PRODUCT SPECIFICATION	NUMBER	GS-12-083
	TITLE	Single and Multi-Port Jack Assemblies		PAGE 2 of 26 REVISION J AUTHORIZED BY J.R. VOLSTORF DATE 7-Jun-06 STATUS UNRESTRICTED

## Table of Contents

<b>1.</b>	<b>OBJECTIVE.....</b>	<b>5</b>
<b>2.</b>	<b>SCOPE .....</b>	<b>5</b>
<b>3.</b>	<b>GENERAL .....</b>	<b>5</b>
<b>4.</b>	<b>APPLICABLE DOCUMENTS .....</b>	<b>5</b>
4.1.	Engineering Documents .....	5
4.2.	Military Specifications .....	5
4.3.	Military Standards .....	5
4.4.	Federal Standards .....	5
4.5.	Industry Standards.....	6
4.6.	FCI Specifications.....	6
4.7.	Conflicting documents and detailed customer specifications.....	6
<b>5.</b>	<b>REQUIREMENTS.....</b>	<b>6</b>
5.1.	Qualification .....	6
5.2.	Materials .....	6
5.2.1.	Housings and other plastic components.....	6
5.2.2.	Contact Materials .....	7
5.2.3.	Shield Materials.....	7
5.2.4.	Inductive Core Materials .....	7
5.3.	Finish .....	7
5.4.	Design and Construction .....	7
5.4.1.	Minimum Insulation Distances.....	8
5.4.2.	Contact Spring Alignment .....	8
5.4.3.	Workmanship .....	8
5.5.	Mating Plugs .....	8
5.5.1.	Surface Finish .....	8
5.5.2.	Plating Finish.....	8
5.5.3.	Plug Configuration.....	8
5.6.	Store Condition .....	9
<b>6.</b>	<b>ELECTRICAL CHARACTERISTICS .....</b>	<b>13</b>
6.1.	Contact Resistance, Low Level (LLCR).....	13
6.2.	Insulation Resistance.....	14
6.3.	Dielectric Withstanding Voltage.....	14
6.3.1.	Dielectric Withstanding Voltage between adjacent contacts .....	14
6.3.2.	Dielectric Withstanding Voltage between contacts and shield .....	14
6.4.	Transfer Impedance or Shielding Effectiveness Test.....	14
6.4.1.	Transfer Impedance .....	15
6.4.2.	Shielding System Effectiveness .....	15
6.5.	Capacitance .....	15
6.6.	Impedance .....	15
6.7.	Open Circuit DC Resistance.....	16
6.8.	Connector Category Requirements.....	17

	TYPE	PRODUCT SPECIFICATION		NUMBER	GS-12-083			
	TITLE	Single and Multi-Port Jack Assemblies			PAGE	3 of 26	REVISION	J
				AUTHORIZED BY	J.R. VOLSTORF		DATE	7-Jun-06
				STATUS	UNRESTRICTED			

6.8.1.	Attenuation (Insertion Loss) .....	17
6.8.2.	NEXT Loss .....	17
6.8.3.	Return Loss .....	18
6.8.4.	DC Resistance. ....	18
6.9.	Current Rating and Current Carrying Capacity .....	19
<b>7.</b>	<b>MECHANICAL CHARACTERISTICS .....</b>	<b>19</b>
7.1.	Mating and Unmating Forces.....	19
7.2.	The Spring Form and Shield Tabs.....	19
7.3.	Retention.....	20
7.3.1.	Effectiveness of connector coupling device .....	20
7.3.2.	Overall Assembly After Soldering .....	20
7.3.3.	Jack to Board. ....	20
7.4.	Vibration and Mechanical Shock .....	20
7.4.1.	Vibration .....	20
7.4.2.	Mechanical Shock .....	20
7.5.	Six position plug stress test .....	20
<b>8.</b>	<b>ENVIRONMENTAL CONDITIONS.....</b>	<b>21</b>
8.1.	Thermal Shock - EIA 364-32 (Tested Unmated) .....	21
8.2.	Humidity, Steady State - EIA 364-31, Method II.....	21
8.3.	High Temperature Life - EIA 364-17 .....	21
8.4.	Hydrogen Sulfide (H2S) - BUS-03-302 (Mated) .....	21
8.5.	Resistance to Solvents. ....	21
8.6.	Durability. ....	21
8.7.	Solderability .....	22
8.8.	Resistance to Soldering Heat. ....	22
<b>9.</b>	<b>QUALITY ASSURANCE PROVISIONS.....</b>	<b>22</b>
9.1.	Equipment Calibration. ....	22
9.2.	Inspection Conditions. ....	22
9.3.	Sample Quantify and Description. ....	23
9.4.	Acceptance .....	23
9.5.	Qualification Testing .....	23
9.6.	Requalification Testing .....	23
<b>10.</b>	<b>NOTES AND DEFINITIONS.....</b>	<b>25</b>
<b>11.</b>	<b>REFERENCE DOCUMENTS .....</b>	<b>25</b>

	TYPE	PRODUCT SPECIFICATION		NUMBER	GS-12-083			
	TITLE	Single and Multi-Port Jack Assemblies			PAGE	4 of 26	REVISION	J
				AUTHORIZED BY	J.R. VOLSTORF		DATE	7-Jun-06
				STATUS	UNRESTRICTED			

Figure 1 – Unshielded Mating Plug.....9

Figure 2 – Unshielded Mating Plug.....10

Figure 3 – 8 Position keyed Plug Mechanical Specification .....11

Figure 4 – Contact Resistance Connections and Test Procedure .....13

Figure 5 – Current Carrying Capacity .....19

Table 1 – Insulation Distances.....8

Table 2 – Mating Plug Outside Dimensional Requirements .....8

Table 3 – Shielding Effectiveness.....15

Table 4 – Impedance form 1Mhz to 100 Mhz .....16

Table 5 – Attenuation of Connecting Hardware used for 100Ω UTP Cable .....17

Table 6 – UTP Connecting Hardware NEXT Loss .....17

Table 7 – Test Procedures for Durability Levels 1, 2, 3 and 4 .....22

Table 8 – Qualification Test Sequences .....24

	TYPE	PRODUCT SPECIFICATION		NUMBER	GS-12-083		
	TITLE	Single and Multi-Port Jack Assemblies		PAGE	5 of 26	REVISION	J
				AUTHORIZED BY	J.R. VOLSTORF	DATE	7-Jun-06
				STATUS	UNRESTRICTED		

## 1. **OBJECTIVE**

This specification defines the performance, test, quality and reliability of a family of modular telephone connectors.

## 2. **SCOPE**

This specification defines requirements for Receptacles of Modular Telephone connectors intended for use in private and public network installations and equipment. The receptacles specified herein can comprise single or multiport configurations (Gang Jacks), shielded and unshielded designs, filtered and unfiltered. Receptacles supplied according to this specification can be classified as category 3, 4 and 5 assemblies. This specification also covers the Modular Jacks and Gang Jacks that do not require category classification. The mating plug is described in this specification only to the extent necessary to define performance of the mated connector parts: to this extent the quality of a mating plug shall conform to this document.

## 3. **GENERAL**

The purpose of this document is to provide information on product performance requirements of the NetJack designs and test methods to confirm.

## 4. **APPLICABLE DOCUMENTS**

### 4.1. ***Engineering Documents***

See individual customer and inspection drawings.

### 4.2. ***Military Specifications***

MIL-F-55110	Printed wiring boards
MIL-G-45204	Gold plating (electro deposited)

### 4.3. ***Military Standards***

MIL-STD-1344	Test Methods for Electrical Connectors
MIL-STD-202	Test Methods for Electronic & Electrical Component Parts
MIL-STD-2166	

### 4.4. ***Federal Standards***

FCC Part 68F	Registration of Telephone Equipment
FED STD 595	Colors
QQ-N-290	Nickel Plating

	TYPE	PRODUCT SPECIFICATION		NUMBER	GS-12-083			
	TITLE	Single and Multi-Port Jack Assemblies			PAGE	6 of 26	REVISION	J
				AUTHORIZED BY	J.R. VOLSTORF		DATE	7-Jun-06
				STATUS	UNRESTRICTED			

#### 4.5. Industry Standards

ANSI-J-002	Joint Industry Standard, Solderability test for component leads
ASTM B-103	Phosphor bronze wire
ASTM B-159	Phosphor Bronze plate, sheet strip, and rolled bar
ASTM D 4566	DC Resistance Measurement
EIA/TIA 568A,B	Commercial Building Communications Cabling Standard
EIA-364 Series	Electrical Connector Test Procedures Incl.. Environmental Classif.
IEC-512-5	Impact Tests, Static Load Tests, Endurance & Overload Tests
IEC-603-7	Connectors for Frequencies below 3 MHz for use with circuit boards
IEC 61196	transfer Impedance Test
ISO 10012-1	Quality Assurance Requirements for Measuring Equipment
ISO 9000	Quality System Requirements
UL94	Test for Flammability of Plastic Materials

#### 4.6. FCI Specifications

BUS-02-043	Plating Documentation Standards
BUS-02-057	Plating Selection Guidelines
BUS-03-107	Shielding Effectiveness
BUS-03-114	Capacitance Measurement
BUS-03-302	Sulfide Vapor Test
BUS-03-404	Normal Force Measurement
BUS-03-405	Insertion/Withdrawal force Measurement
BUS-03-601	Current Rating/30°C Temperature Rise

#### 4.7. Conflicting documents and detailed customer specifications

In the event of any conflict between this specification and any other applicable document, this specification shall take precedence. If differences exist between this specification and detailed customer specification it is allowed to furnish products that are covered only in part by this specification.

## 5. REQUIREMENTS

### 5.1. Qualification

Connectors furnished under this specification shall be capable of meeting the qualification test requirements specified herein.

### 5.2. Materials

#### 5.2.1. Housings and other plastic components

All plastic components shall be made of a flame-retardant thermoplastic material with flammability grade UL 94 V-0. Allowable materials include PCT, polyamide 4/6, polyamide 6/6, polyester, LCP. The exact material shall be specified in the detailed drawings.

	TYPE	PRODUCT SPECIFICATION		NUMBER	GS-12-083
	TITLE	Single and Multi-Port Jack Assemblies		PAGE	7 of 26
				REVISION	J
				AUTHORIZED BY	J.R. VOLSTORF
				DATE	7-Jun-06
				STATUS	UNRESTRICTED

### 5.2.2. Contact Materials

Contacts shall be made of high performance phosphor bronze alloy 510 in accordance to ASTM B-103 or ASTM B-159.

Plating requirements in a contact area shall conform to one of the listed below:

- A. 0.000075mm min. gold flash (3 microinches)  
0.00076mm palladium nickel over (30 microinches)  
0.00254mm nickel minimum (100 microinches)
- B. 0.00076mm gold finish over (30 microinches)  
0.00127mm min. nickel underplate minimum (50 microinches)
- C. 0.00127mm gold finish over (50 microinches)  
0.00127mm nickel underplate minimum (50 microinches)

In the solder tail area, it is allowed to have one of the platings A, B, or C listed above or 0.00254mm (100 microinches) of tin-lead solder with composition of 90% tin and 10% lead.

Lubrication requirements shall be specified on the detailed drawings.

### 5.2.3. Shield Materials

Shields shall be made of copper alloy. Allowable materials include Cartridge Brass alloy C260, yellow brass C260 and phosphor bronze alloy C510. Shield thickness and material temper shall be specified in detailed drawings.

Plating Finish: 0.00254mm min. of bright tin  
Underplate: 0.00051mm min. nickel or 0.001 min. copper

### 5.2.4. Inductive Core Materials

Inductive cores shall be made of ferrite ceramics with Curie temperature above 250 degrees Celsius. Unless otherwise specified in the detailed drawings, the initial permeability shall be above 800 and saturation flux density from 1800 to 3600 gauss.

### 5.3. Finish

The finish for applicable components shall be as specified herein or equivalent. Reference BUS-02-057.

### 5.4. Design and Construction

Connectors shall be of the design, construction, and physical dimensions specified on the applicable product drawing.

Insulation co-ordination is not required for these connectors.

	TYPE	PRODUCT SPECIFICATION		NUMBER	GS-12-083			
	TITLE	Single and Multi-Port Jack Assemblies			PAGE	8 of 26	REVISION	J
				AUTHORIZED BY	J.R. VOLSTORF		DATE	7-Jun-06
				STATUS	UNRESTRICTED			

### 5.4.1. Minimum Insulation Distances.

Table 1 – Insulation Distances

Minimum Distance Between Contact and Shield				Minimum Distance Between Adjacent Contacts			
Creepage		Clearance		Creepage		Clearance	
mm	in	mm	In	mm	in	mm	in
1,40	0,055	0,51	0,020	0,36	0,014	0,36	0,014

### 5.4.2. Contact Spring Alignment

Individual contact springs in the unmated jack shall neither touch or cross the plane of adjacent springs when viewed from the front of the jack.

### 5.4.3. Workmanship

Modular Jacks shall be uniform in quality and shall be free from burrs, scratches, cracks, voids, chips, blisters, pin holes, sharp edges, and other defects that will adversely affect life or serviceability.

## 5.5. Mating Plugs

Mating plug shall conform to dimensions specified in Federal Standard FCC Part 68F for all respective plug types (6 and 8 position, unshielded/unshielded, keyed/unkeyed etc).

### 5.5.1. Surface Finish

Electropolished plugs are required for qualification testing. The plug contacts shall be smooth and free of burrs.

### 5.5.2. Plating Finish

The mating plug finish shall be 0.00127mm (30 microinches) minimum of hard gold in accordance with MIL-G-45204, Type II, Grade C in contact area.

### 5.5.3. Plug Configuration

Plugs to be used to mate for testing of unshielded connectors (where required) shall conform to dimensions of Figure 1 or 3

Plugs to be used to mate for testing of shielded connectors (where required) shall conform to dimensions of Figure 2 or 3

Table 2 – Mating Plug Outside Dimensional Requirements

Figure No	Modular Jack	Plug
1	Shielded	Fig. 1
2	Shielded	Fig. 2
3	Keyed	Fig. 3



	TYPE	PRODUCT SPECIFICATION	NUMBER	GS-12-083
	TITLE	Single and Multi-Port Jack Assemblies		PAGE 9 of 26 REVISION J AUTHORIZED BY J.R. VOLSTORF DATE 7-Jun-06 STATUS UNRESTRICTED

**5.6. Store Condition:**

Air temperature: 10°C~30°C  
 Relative humidity: 10%~75%  
 Store life: 1 year

**Figure 1 – Unshielded Mating Plug**

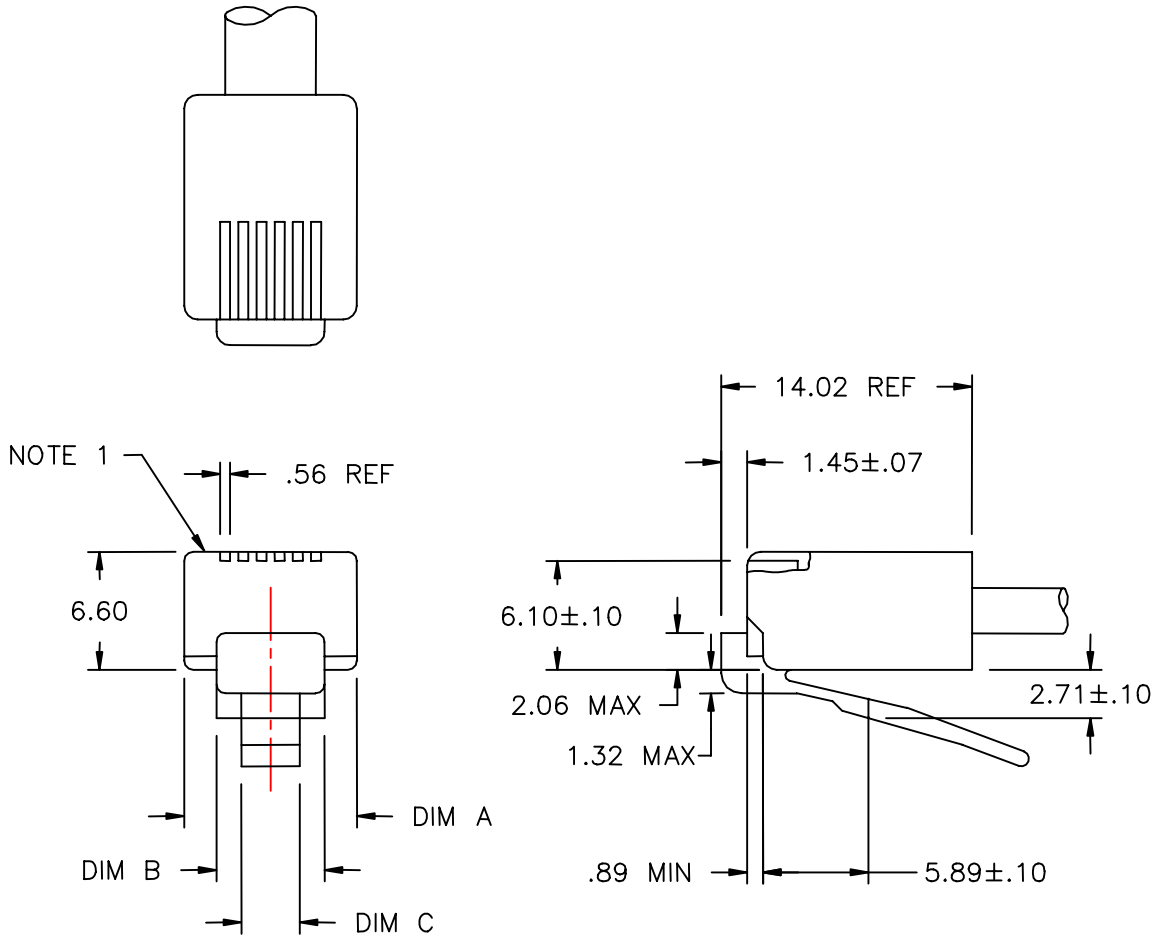

TYPE	POS.	DIM A	DIM B	DIM C
TYPE 616	4	7.62± .01	4.93± 0.1	2.54± 0.1
TYPE 623	6	9.65± 0.1	6.05± 0.1	3.25± 0.1
TYPE 645	8	11.68± 0.1	6.1± 0.1	3.25± 0.1

**NOTES:**

1. AWG 24 SOLID WIRE COMMONLY CONNECTED TO EACH TERMINAL.
2. 0.25 MAXIMUM MISMATCH ALLOWED ON THIS SURFACE
3. MATERIAL COMPATIBLE WITH REQUIREMENTS OF THIS SPECIFICATION.

	TYPE <b>PRODUCT SPECIFICATION</b>	NUMBER <b>GS-12-083</b>	
TITLE <b>Single and Multi-Port Jack Assemblies</b>		PAGE <b>10 of 26</b>	REVISION <b>J</b>
		AUTHORIZED BY <b>J.R. VOLSTORF</b>	DATE <b>7-Jun-06</b>
		STATUS <b>UNRESTRICTED</b>	

**Figure 2 – Unshielded Mating Plug**

	TYPE	PRODUCT SPECIFICATION	NUMBER	GS-12-083
	TITLE	Single and Multi-Port Jack Assemblies		PAGE 11 of 26 REVISION J AUTHORIZED BY J.R. VOLSTORF DATE 7-Jun-06 STATUS UNRESTRICTED

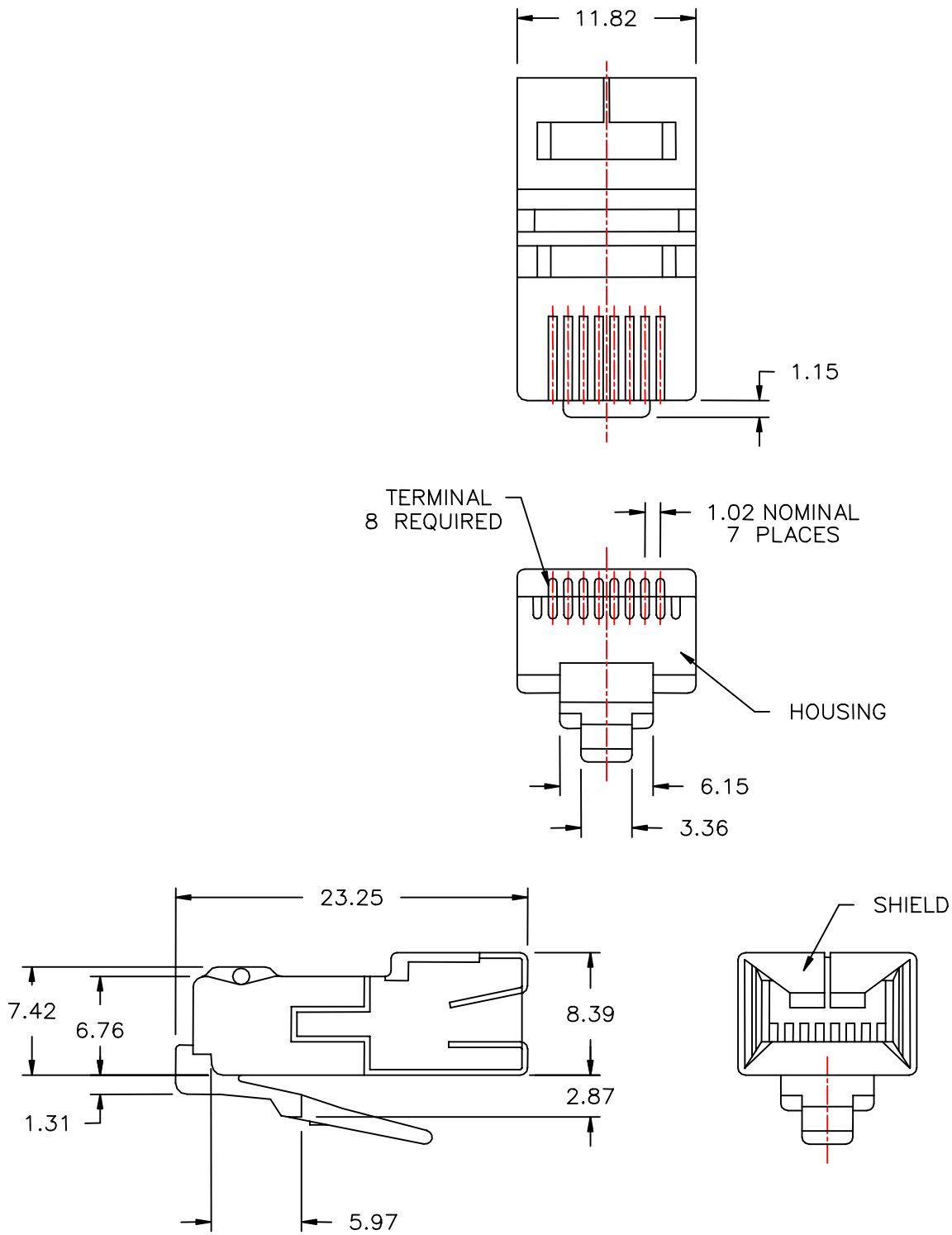

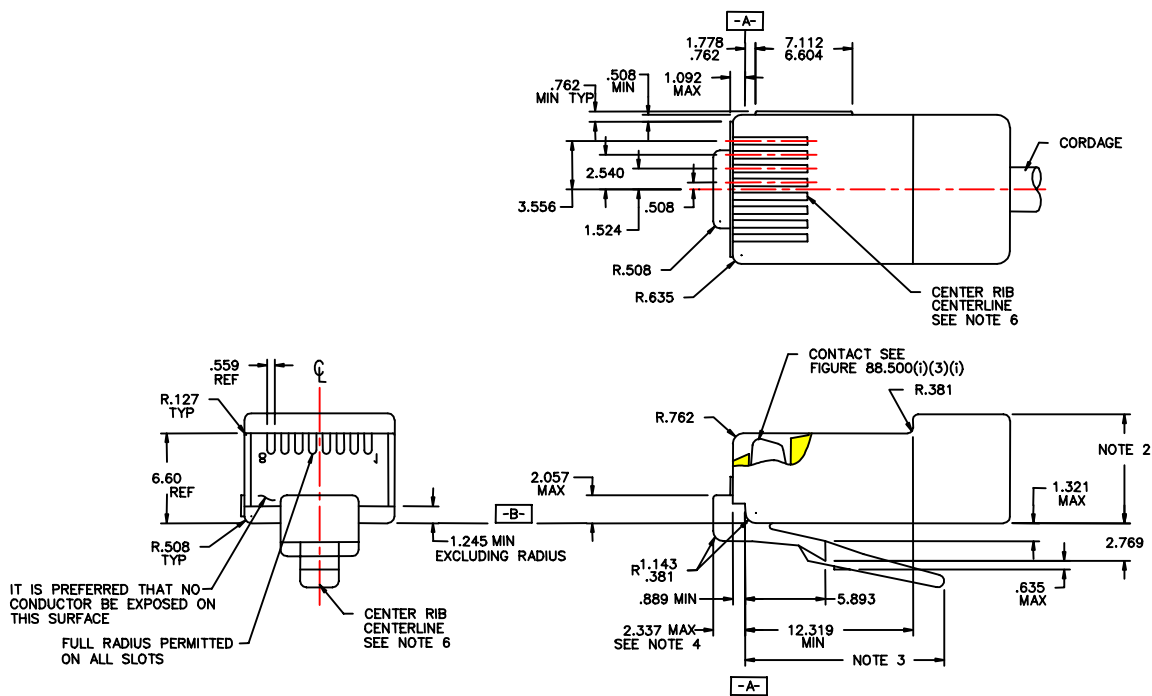



Figure 3 – 8 Position keyed Plug Mechanical Specification

	TYPE <b>PRODUCT SPECIFICATION</b>	NUMBER <b>GS-12-083</b>	
TITLE <b>Single and Multi-Port Jack Assemblies</b>		PAGE <b>12 of 26</b>	REVISION <b>J</b>
		AUTHORIZED BY <b>J.R. VOLSTORF</b>	DATE <b>7-Jun-06</b>
		STATUS <b>UNRESTRICTED</b>	



	TYPE	PRODUCT SPECIFICATION		NUMBER	GS-12-083			
	TITLE	Single and Multi-Port Jack Assemblies			PAGE	13 of 26	REVISION	J
				AUTHORIZED BY	J.R. VOLSTORF		DATE	7-Jun-06
				STATUS	UNRESTRICTED			

## 6. ELECTRICAL CHARACTERISTICS

### 6.1. Contact Resistance, Low Level (LLCR)

The low-level contact resistance shall not exceed 20 milliohms (40 milliohms after environmental exposure) when measured in accordance with EIA 364-23. The LLCR, between the shield tabs and the plug, shall not exceed 80 milliohms after environmental exposure.

The following details shall apply:

- Method of Connection: Attach current and voltage leads as shown in Figure 4.
- Test Voltage: 20 millivolts DC maximum open circuit
- Test Current: Not to exceed 1.0 milliamperes

Where required measure LLCR between (non-gold plated) shield and shielded portion of plug by attaching leads as close to contact area as practical

**Figure 4 – Contact Resistance Connections and Test Procedure**

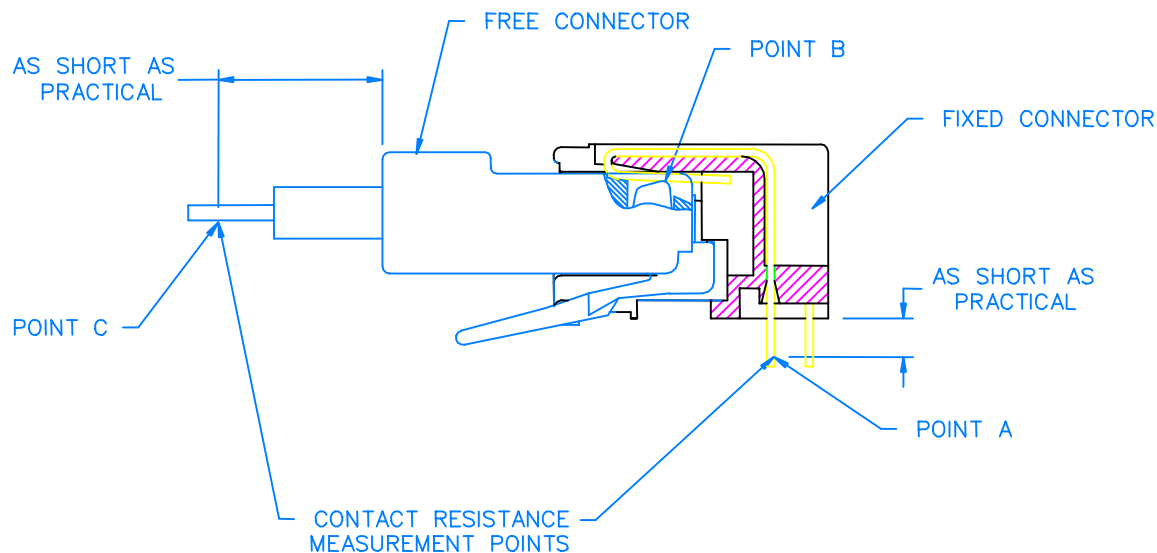

	TYPE	PRODUCT SPECIFICATION		NUMBER	GS-12-083		
	TITLE	Single and Multi-Port Jack Assemblies		PAGE	14 of 26	REVISION	J
				AUTHORIZED BY	J.R. VOLSTORF	DATE	7-Jun-06
				STATUS	UNRESTRICTED		

### Test Procedure

1. Determine the bulk resistance of the fixed connector between points A and B of Figure 4 by calculation or by measurement.
2. Determine the bulk resistance of the free connector between points B and C of Figure 4 by calculation or by measurement.
3. Measure the total mated connector resistance between points A and C.
4. Calculate the contact resistance by subtracting the sum of the bulk resistances of the fixed and free connectors from the total mated connector resistance.

$$\text{Contact resistance} = R_{AC} - (R_{AB} + R_{BC})$$

### **6.2. Insulation Resistance**

The insulation resistance of mated connectors shall not be less than 500 megohms (200 megohms after environmental exposure) when measured in accordance with EIA 364-21. The following details shall apply:

- a. Test Voltage: 100 volts D.C.
- b. Electrification Time: 2 minutes, unless otherwise specified
- c. Points of Measurement: between adjacent contacts

### **6.3. Dielectric Withstanding Voltage**

There shall be no evidence of arc-over, insulation breakdown, or excessive leakage current (> 1 milliamper) when mated connectors arc testing in accordance with EIA 364-20. The following details shall apply:

#### **6.3.1. Dielectric Withstanding Voltage between adjacent contacts**

- a. Test Voltage: 100 volts (DC)
- b. Test Duration: 60 seconds
- c. Test Condition: 1 Atmosphere(760 Torr - sea level)
- d. Points of Measurement: between adjacent contacts

#### **6.3.2. Dielectric Withstanding Voltage between contacts and shield**

- a. Test Voltage: 1,500 volts (DC)
- b. Test Duration: 60 seconds
- c. Test Condition: 1 Atmosphere(760 Torr - sea level)
- d. Points of Measurement: between all contacts connected together and shield

### **6.4. Transfer Impedance or Shielding Effectiveness Test.**

The tests are intended to characterise the quality of a shielding system. One of the tests shall be performed. The transfer impedance is preferred, shielding effectiveness is an optional test. A single port assemblies shall be tested to represent connector family. Only fully shielded connectors shall be tested.

	TYPE	PRODUCT SPECIFICATION		NUMBER	GS-12-083
	TITLE	Single and Multi-Port Jack Assemblies		PAGE	15 of 26
				REVISION	J
				AUTHORIZED BY	J.R. VOLSTORF
				DATE	7-Jun-06
				STATUS	UNRESTRICTED

### 6.4.1. Transfer Impedance

Defined as quotient of the longitudinal voltage in the outer system to the current in the inner system.

$$Z_T = U_2 / I_1$$

Where:  $U_2$  voltage in the outer system  
 $I_1$  current in the inner system  
 $Z_T$  transfer impedance

A triaxial test set-up shall be used in accordance with IEC 61196.  
All terminating resistors shall be 50 ohm  
Maximum value is 1.3 ohm (to be verified)

### 6.4.2. Shielding System Effectiveness

The specification requirement shall be satisfied when evaluated in accordance with FCI Test Specification BUS-03-107 and the following details:

The following requirements are applicable to products with full shield. Every port should have at least three grounding pegs. In lieu of grounding pegs, a copper tape can be used.

No shield effectiveness test required for products with partial shield.

Shielding effectiveness, dB

**Table 3 – Shielding Effectiveness**

SHIELDING EFFECTIVENESS, dB					
@ MHz	25	125	250	500	1000
dB, Minimum	40	30	28	25	22

### 6.5. Capacitance

The specification requirement shall be satisfied when evaluated in accordance with FCI Test Specification BUS-03-114. The measurement shall be taken using unmated connectors between two non-connected contacts where the worst possible case may exist. Probes shall be applied on the PWB side.

Frequency: 1 kHz  
Amplitude: 1 Volt  
Capacitance shall be less 10 pF

### 6.6. Impedance

Only filtered modjacks with inductive filters shall be tested.

The exact requirements shall be listed in appropriate customer specification or supply agreement. Since a very large number of possible filters may be designed to satisfy a large number of applications, the below listed table applies only to inductive filters furnished under part-numbers 95110-001, -002, and -004. Deviations of + or -20% from the nominal values listed in Table 6.6 are acceptable.

	TYPE	PRODUCT SPECIFICATION		NUMBER	GS-12-083	
	TITLE			PAGE	REVISION	
Single and Multi-Port Jack Assemblies			16 of 26	J		
			AUTHORIZED BY	DATE		
			J.R. VOLSTORF	7-Jun-06		
			STATUS			
			UNRESTRICTED			

**Table 4 – Impedance form 1Mhz to 100 Mhz**

<u>Frequency Mhz</u>	<u>Impedance Ohm</u>
1	0.5
10	22
20	60
30	100
40	110
50	120
60	120
70	135
80	140
90	145
100	150
200	155
400	170
800	180
1000	180

### **6.7. Open Circuit DC Resistance**

Open circuit DC resistance shall exceed 16 Mohm when measured for 60 seconds.  
 All measurements to be performed on the PWB side of the assemblies. Test voltage shall not exceed 100V DC.  
 Test probes shall be applied to two normally non-connected contacts.



	TYPE	PRODUCT SPECIFICATION		NUMBER	GS-12-083			
	TITLE	Single and Multi-Port Jack Assemblies			PAGE	17 of 26	REVISION	J
				AUTHORIZED BY	J.R. VOLSTORF		DATE	7-Jun-06
				STATUS	UNRESTRICTED			

## 6.8. Connector Category Requirements.

Connector categories are defined in EIA/TIA 568A specification.

### 6.8.1. Attenuation (Insertion Loss)

Worst case attenuation of any pair within a connector shall not exceed the values listed in the following table at each specified frequency for a given performance category.

**Table 5 – Attenuation of Connecting Hardware used for 100Ω UTP Cable**

Frequency (Mhz)	Category 3 (dB)	Category 4 (dB)	Category 5 & 5E (dB)
1.0	0.4	0.1	0.1
4.0	0.4	0.1	0.1
8.0	0.4	0.1	0.1
10.0	0.4	0.1	0.1
16.0	0.4	0.2	0.2
20.0	-	0.2	0.2
25.0	-	-	0.2
31.25	-	-	0.2
62.5	-	-	0.3
100.0	-	-	0.4

### 6.8.2. NEXT Loss

NEXT loss is a measure of signal coupling from one circuit within a connector and is derived from swept frequency voltage measurements on short lengths of 100 Ω twisted-pair test leads terminated to the connector under test. A balanced input signal is applied to a disturbing pair of the connector while the induced signal on the disturbed pair is measured at the near-end of the test leads.

**Table 6 – UTP Connecting Hardware NEXT Loss**

Frequency (Mhz)	Category 3 (dB)	Category 4 (dB)	Category 5 (dB)	Category 5E (dB)
1.0	58	65	65	65
4.0	46	58	65	65
8.0	40	52	62	65
10.0	38	50	60	63
16.0	34	46	56	59
20.0	-	44	54	57
25.0	-	-	52	55
31.25	-	-	50	53
62.5	-	-	44	47
100.0	-	-	40	43

	TYPE	PRODUCT SPECIFICATION		NUMBER	GS-12-083			
	TITLE	Single and Multi-Port Jack Assemblies			PAGE	18 of 26	REVISION	J
				AUTHORIZED BY	J.R. VOLSTORF		DATE	7-Jun-06
				STATUS	UNRESTRICTED			

### 6.8.3. Return Loss

Connector return loss is a measure of the degree of impedance matching between the cable and connector and is derived from swept frequency voltage measurements on short lengths of 100  $\Omega$  twisted-pair test leads before and after inserting the connector under test. A balanced input signal is applied to a connector pair while signals that are reflected back due to impedance discontinuities are measured at the same port from which the signal is applied. The same set-up that is used for NEXT loss measurements is also used for return loss, except that only a single connection is made to the network analyzer.

Because the return loss characteristics of category 3 connector hardware are not considered to have a significant effect on the link performance of category 3 UTP cabling, return loss requirements are not specified for category 3 connectors.

For category 4 and 5 connectors, the minimum return loss shall be 23 dB or greater for frequencies between 1 and 20 Mhz. For frequencies from 20 to 100 Mhz, category 5 connectors shall exhibit a minimum return loss of 14 dB or greater. These return loss values are chosen to limit peak reflected voltage to 7% or less up to 20 Mhz and to 20% or less from 20 to 100 Mhz.

### 6.8.4. DC Resistance.

The DC resistance between the input and output connections of the connecting hardware (not including the cable stub, if any) used for 100  $\Omega$  cabling shall not exceed 0.3  $\Omega$  when tested in accordance with ASTM D 4566.

NOTE: DC resistance is a separate measurement from the contact resistance measurements required in normative Annex A. Whereas DC resistance is measured to determine the connector's ability to transmit direct current and low frequency signals, contact resistance measurements are used to determine the reliability and stability of individual electrical connections.

	TYPE	PRODUCT SPECIFICATION		NUMBER	GS-12-083			
	TITLE	Single and Multi-Port Jack Assemblies			PAGE	19 of 26	REVISION	J
				AUTHORIZED BY	J.R. VOLSTORF		DATE	7-Jun-06
				STATUS	UNRESTRICTED			

## 6.9. Current Rating and Current Carrying Capacity

The temperature rise above ambient shall not exceed 30 degrees C at any point in the system when all contacts connected in series are powered with 1A current

The following details shall apply:

- Ambient Conditions - still air at 25 degrees C
- Reference - BUS-03-601
- Connector derating curve shall be as shown in the following figure

**Figure 5 – Current Carrying Capacity**

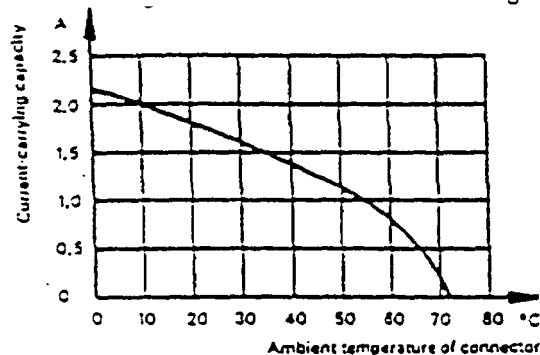

## 7. MECHANICAL CHARACTERISTICS

### 7.1. Mating and Unmating Forces.

Both forces measured with latch depressed or removed shall not exceed 35 Newtons.

- Cross head speed 10mm/s (0.4 in/s) Max, 0.2mm/s (0.008 in/s) Min.
- Lubrication is required on jacks and plugs
- Only free floating fixtures are allowed for use

### 7.2. The Spring Form and Shield Tabs.

The spring contact ends shall be located in the individual slots.

Shield tabs intended for contact with PWB (bottom) or panel cut-out shall withstand 3 insertions in the designated panel cut-out or manual depression. The spring form, measured as maximum dimension from a shield shall not change its position by more than 0.254mm (0.010").

Shield tabs intended for contact with shielded plug shall meet test conditions specified in paragraph titled 'Durability' of this specification.

	TYPE	PRODUCT SPECIFICATION		NUMBER	GS-12-083			
	TITLE	Single and Multi-Port Jack Assemblies			PAGE	20 of 26	REVISION	J
				AUTHORIZED BY	J.R. VOLSTORF		DATE	7-Jun-06
				STATUS	UNRESTRICTED			

### 7.3. Retention

#### 7.3.1. Effectiveness of connector coupling device.

There shall be no evidence of mechanical damage to the jack, plug or latching mechanism, nor separation of the plug from the jack when a static load of 50 N is applied between the jack and plug in the direction of normal removal for 60 seconds while clamped in place to support shearing between the board and jack.

#### 7.3.2. Overall Assembly After Soldering.

There shall be no evidence of mechanical damage to the jack, plug or latching mechanisms, nor of the plug from the jack or jack from the printed wiring board when a static load of 22 Newtons is applied between the plug and the board in the direction of normal plug removal.

#### 7.3.3. Jack to Board.

This section does not apply to jacks without snap-in-pegs or press pegs. Prior to soldering, the jack shall withstand a force applied between the jack and board in a direction normal to the plane of the board as follows:

Snap-in pegs - 14.N  
Diamond pegs (3.38mm in 3.20mm holes - 5.0N)

### 7.4. Vibration and Mechanical Shock

#### 7.4.1. Vibration

Part shall be mounted onto PWB or fixtures. Vibration test shall be performed in accordance to EIA 364-TP28B, test condition II (10 g sinusoidal excitation). Test duration shall be 2 hours on each of three mutually perpendicular axes. An event detector shall monitor continuity during vibration testing for events of at least 50 ohm lasting 1.0 microsecond or longer.

#### 7.4.2. Mechanical Shock

Mechanical shock test shall be performed in accordance to EIA-364-TP27, test condition H (11 ms, 30g Half-sine excitation). Samples shall be subjected to three shocks in each direction along each of the three mutually perpendicular axes of the samples, for a total of 18 shock impulses. An event detector shall monitor continuity during mechanical shock testing for events of at least 50 ohm lasting 1.0 microsecond or longer.

### 7.5. Six position plug stress test

Eight position, non-keyed jacks with stamped leadframe style terminals shall be capable of withstanding mating with a six position FCC specified plug and not suffer overstress damage to pins #1 and #8. After plugging ten times with a six-position plug, pins 1 and 8 shall maintain 100 grams minimum normal force when measured with a FCC minimum sized plug.

	TYPE	PRODUCT SPECIFICATION		NUMBER	GS-12-083
	TITLE	Single and Multi-Port Jack Assemblies		PAGE	21 of 26
				REVISION	J
				AUTHORIZED BY	J.R. VOLSTORF
				DATE	7-Jun-06
				STATUS	UNRESTRICTED

## 8. ENVIRONMENTAL CONDITIONS

After exposure to the following environmental conditions in accordance with the specified test procedure and/or details, the product shall show no physical damage and shall meet the electrical and mechanical requirements per paragraphs 6.0 and 7.0 as specified in the Table 8 "Qualification Test Sequences". Unless specified otherwise, assemblies shall be mated during exposure.

### 8.1. ***Thermal Shock - EIA 364-32 (Tested Unmated)***

- a) Number of Cycles: 5
- b) Temperature Range: between -40 and +70 degrees C
- c) Time at Each Temperature: 30 minutes
- d) Transfer Time: 5 minutes, maximum

### 8.2. ***Humidity, Steady State - EIA 364-31, Method II***

- a) Relative Humidity: 95%
- b) Temperatures: +40 degrees C
- c) Test Condition: A (96 hours)

### 8.3. ***High Temperature Life - EIA 364-17***

- a) Test Temperature: 70 degrees C
- b) Test Duration: 500 hours

### 8.4. ***Hydrogen Sulfide (H2S) - BUS-03-302 (Mated)***

- a) Duration: 48 hours
- b) Temperature: 40 degrees C
- c) Test Vessel: 9000 milliliter glass desiccator

### 8.5. ***Resistance to Solvents.***

The housing shall exhibit no deterioration after exposure to various solvents commonly used in past-soldering cleaning procedures. The test shall be in accordance with EIA 364-11 at room temperature.

### 8.6. ***Durability.***

The following durability levels are specified:  
The durability test level shall be specified in the Laboratory Work Order.

- Level 1 - 250 cycles
- Level 2 - 750 cycles
- Level 3 - 1000 cycles
- Level 4 - 2500 cycles

	TYPE	PRODUCT SPECIFICATION		NUMBER	GS-12-083			
	TITLE	Single and Multi-Port Jack Assemblies			PAGE	22 of 26	REVISION	J
				AUTHORIZED BY	J.R. VOLSTORF		DATE	7-Jun-06
				STATUS	UNRESTRICTED			

After the durability testing, the spring form shall remain as specified in paragraph 7.2. The contact resistance shall not exceed 40 milliohms for signal lines and/or 80 milliohms for shield tabs. Test method per IEC 512-5, Test 9a.

For durability levels 2 and 4, perform half of the cycles, then mixed flowing gas followed by the remaining half of the durability cycles

**Table 7 – Test Procedures for Durability Levels 1, 2, 3 and 4**

<b>Level 1</b>	250 cycles	LLCR	Mixed flowing gas Per IEC 603-7 Annex D	N/A	N/A
<b>Level 2</b>	375 cycles	LLCR	Mixed flowing gas Per IEC 603-7 Annex D	LLCR	375 cycles
<b>Level 3</b>	500 cycles	LLCR	Mixed flowing gas Per IEC 603-7 Annex D	LLCR	500 cycles
<b>Level 4</b>	1250 cycles	LLCR	Mixed flowing gas Per IEC 603-7 Annex D	LLCR	1250 cycles

### 8.7. Solderability

ANSI-J-002, Test Condition A

- a) Steam aging: 1 hour
- b) Contact areas evaluated shall meet the ANSI-J-002 requirements.

### 8.8. Resistance to Soldering Heat.

The housing shall withstand the high temperatures encountered during soldering of the jack to the printed wiring board without any functional deterioration.

The test shall be in accordance with MIL-STD-202, Method 210, Test Condition E. The following details shall apply:

- a) Solder Temperature: 260 degrees C
- b) Immersion Duration: 5 seconds

## 9. QUALITY ASSURANCE PROVISIONS

### 9.1. Equipment Calibration.

All test equipment and inspection facilities used in the performance of any test shall be maintained in a calibration system in accordance with MIL-C-45662 and ISO 9000.

### 9.2. Inspection Conditions.

Unless otherwise specified herein, all inspections shall be performed under the following ambient conditions:

- a) Temperature: 25 +/- 5 degrees C
- b) Relative Humidity: 30% to 60%
- c) Barometric Pressure: Local ambient

	TYPE	PRODUCT SPECIFICATION		NUMBER	GS-12-083			
	TITLE	Single and Multi-Port Jack Assemblies			PAGE	23 of 26	REVISION	J
				AUTHORIZED BY	J.R. VOLSTORF		DATE	7-Jun-06
				STATUS	UNRESTRICTED			

### 9.3. **Sample Quantify and Description.**

Unless specified otherwise, the sample quantity for each Test Group in Table 1 shall consist of a minimum of thirty (30) contacts. The 30 contacts shall be selected from a minimum of three (3) connectors. In connector families where conditions such as size, type, plating, material type, etc. would be expected to affect test results, samples should be included to evaluate those conditions in the affected Test Groups of Table 8.

Results obtained from testing multiport assemblies are applicable to similar products of other number of ports. Multiport assemblies of representative size (typically 4, 6, 8, or 12 ports) shall be used for mechanical and environmental tests assigned to Group 1. Other test groups can utilize single or multiport assemblies as practical.

### 9.4. **Acceptance**

Electrical and mechanical requirements placed on test samples as indicated in paragraphs 6.0 and 7.0 shall be established from test data using appropriate statistical techniques or shall otherwise be customer specified, and all samples tested in accordance with this product specification shall meet the stated requirements.

Failures attributed to equipment, test set-up, or operator error shall not disqualify the product. If product failure occurs, corrective action shall be taken and samples resubmitted for qualification.

### 9.5. **Qualification Testing**

Qualification testing shall be performed on sample units produced with equipment and procedures normally used in production. The test sequence shall be as shown in Table 8.

### 9.6. **Requalification Testing**

If any of the following conditions occur, the responsible product engineer shall initiate requalification testing consisting of all applicable parts of the qualification test matrix, Table 8.

- a) A significant design change is made to the existing product, which impacts the product form, fit or function. Examples of significant changes shall include, but not be limited to, changes in the plating material composition or thickness, contact force, contact surface geometry, insulator design, contact base material, or contact lubrication requirements.
- b) A significant change is made to the manufacturing process, which impacts the product form, fit or function.
- c) A significant event occurs during production or end use requiring corrective action to be taken relative to the product design or manufacturing process.

	TYPE	PRODUCT SPECIFICATION	NUMBER	GS-12-083		
	TITLE	Single and Multi-Port Jack Assemblies		PAGE	24 of 26	REVISION
			AUTHORIZED BY	J.R. VOLSTORF	DATE	7-Jun-06
			STATUS	UNRESTRICTED		

**Table 8 – Qualification Test Sequences**

Test	Para.	Test Group										
		1	2	3	4	5	6	7	8	9	10	11
Examination of Product	5.4	1,15	1,11	1,7	1,7	1,10	1,4	1,4	1,9	1	1	1,9
Mating Plugs Selection	5.5	2	2	2	2	2	2		2		2	2
Low Level Contact Resistance	6.1	3,5,7,9,11	3,6,9		4,6				3,5		3,5	3,6,8
Insulation Resistance	6.2			3					6			
Dielectric Withstanding Voltage	6.3			4					7			
Current Rating	6.8			5								
Transfer Impedance or System Effectiveness	6.4				3		3					
Continuity	6.7.4					6						
Insertion Loss	6.7.1					3						
Return Loss	6.7.3					5						
DC Resistance	6.6					8						
NEXT Loss	6.7.2					4						
Capacitance	6.5			6					8			
Common Mode Rej.	6.7.5					7						
High Voltage Forw. Drop	6.7.6					9						
Choke Inductance *	6.7.7											
Mating/Unmating force	7.1	4,12	4,7									
Retention	7.3	13	10									
Vibration	7.4.1											5
Mechanical Shock	7.4.2											7
Spring Form and Shield Tabs	7.2	14										
6 Position Plug Stress Test	7.5											4
Thermal Shock	8.1	6	5									
Humidity, Steady State	8.2	8							4			
Hi Temperature Life	8.3	10										
Hydrogen Sulfide Gas	8.4				5							
Durability	8.6		8								4	
Solderability	8.7									2		
Resistance to Soldering Heat	8.8							2				
Resistance to Solvents	8.5							3				

- **note: optional test**



	TYPE <b>PRODUCT SPECIFICATION</b>	NUMBER <b>GS-12-083</b>	
TITLE <b>Single and Multi-Port Jack Assemblies</b>		PAGE <b>25 of 26</b>	REVISION <b>J</b>
		AUTHORIZED BY <b>J.R. VOLSTORF</b>	DATE <b>7-Jun-06</b>
		STATUS <b>UNRESTRICTED</b>	

## 10. NOTES AND DEFINITIONS

Maximum thickness of nickel underplate shall not exceed 0.038mm (150 microinches).

## 11. REFERENCE DOCUMENTS

See Section 4.0 (Applicable Documents).

	TYPE	PRODUCT SPECIFICATION		NUMBER	GS-12-083			
	TITLE	Single and Multi-Port Jack Assemblies			PAGE	26 of 26	REVISION	J
				AUTHORIZED BY	J.R. VOLSTORF		DATE	7-Jun-06
				STATUS	UNRESTRICTED			

### REVISION RECORD

REV	PAGE	DESCRIPTION	ECR#	DATE
A	ALL	New Release	V61436	10/01/96
B	3 to 10, 14,16, 19,20	Revised Applicable Document Listing, Added Lubrication requirement to para 5.2.2. Removed lubrication requirement in para. 5.2.2. Redrew Figure 1,2,3,4 for clarity. Added Max/Min to para. 7.1a. Remove lubrication requirement in para. 8.6. Correct para. Numbers and test sequence numbers. Remove para. 10.2 Durability lubrication requirement. Moved Reference Documents to Section 4.0	V70731	11/19/97
C	ALL	Change guardian name. Change all Berg to FCI. Added Vibration,Para. 7.4	V91307	08/05/99
D	17,20	Add Test procedures levels to 8.6. Remove 7,9,6,4,8 from Test Group 10.	V92010	10/08/99
E	7,8,9,1 1,15,17 ,20	Removed Figures 1, 2, and 3.- Added statement for FCC compliant plugs, Added 6.3.1 and 6.3.2, Added 6.4.1 Transfer impedance and 6.4.2 Shielding Effectiveness, Remove 7.3.2 and 7.3.4. Removed level 2 of durability in 8.6. Removed 7.2 from group 1 and added to group 2 in test sequence table. Add Cat5E performance parameters to 7.6.1 and 7.6.2. Change BUS to AMR	V00674	3/29/00
F	4,5,9,1 1,12,15	Remove "unshielded connectors" and "Category 3 and 4 shielded connectors" categories from paragraph 7.1. All jacks to meet 35 Newton force requirement. Decrease normal force value in paragraph 8.9.1 from 100 to 70 grams minimum after six position plug stress test. Changed AMR to BUS throughout Spec	V10430	3/27/01
G	ALL	Change logo, add product pictures on first page, add plug definitions-figures 1, 2 & 3 and add tables of contents, figures and tables	V20899	5/8/02
H	All	Change logo	V06-0547	06/07/06
J	2,9	Add store condition	N08-0254	11/19/08