

ADAM TECH IDC DIP & TRANSITION PLUGS

ADAM TECHNOLOGIES

.100" [2.54] CENTERLINE
FTR & FDP SERIES

INTRODUCTION:

Adam Tech's Flat Cable DIP & Transition plugs are a one piece connector system that quickly and easily mass terminates flat cable then mounts directly to the PCB or PCB socket. These connectors are ideal for interconnecting PCB's in a permanent flat cable transition or satisfying disconnect applications. Our low profile design allows a higher board to board stacking density.

FEATURES:

Available in 8 – 64 positions
Eliminates need for two piece header / Socket set
Fast easy mass termination without stripping cable
Heavy duty Tin plated contacts
Low Profile, high density board to board stacking
Plugs into IC Socket or solders directly to PCB

SPECIFICATIONS:

Material:

Insulator: PBT, rated UL94V-0
Insulator Color: Black (Gray optional)
Contacts: Brass

Contact Plating:

G = Gold flash (30u" optional) over nickel underplate on contact area,
Tin over copper underplate on IDC area.
T = Tin over copper underplate overall

Electrical:

Operating voltage: 250V AC max.
Current rating: 3 Amp max
Contact resistance: 20 mΩ max. initial
Insulation resistance: 5000 MΩ min.
Dielectric withstanding voltage: 1000V AC for 1 minute

Mechanical:

Recommended cable size: 28 Awg stranded

Temperature Rating:

Operating temperature: -55°C to +105°C

PACKAGING:

Anti-ESD plastic trays

SAFETY AGENCY APPROVALS:

UL Recognized File No. E224053
CSA Certified File No. LR1578596

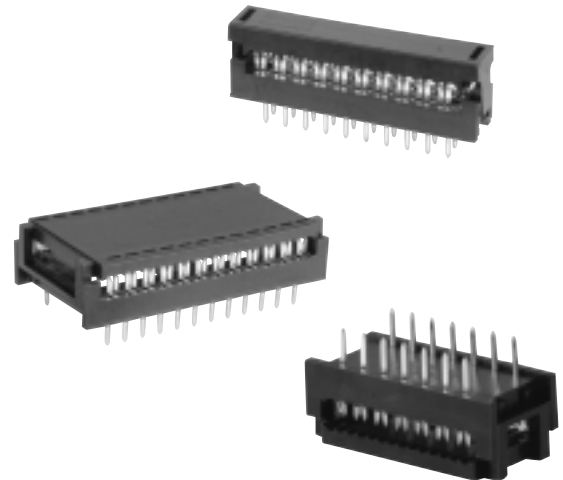
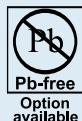

ORDERING INFORMATION

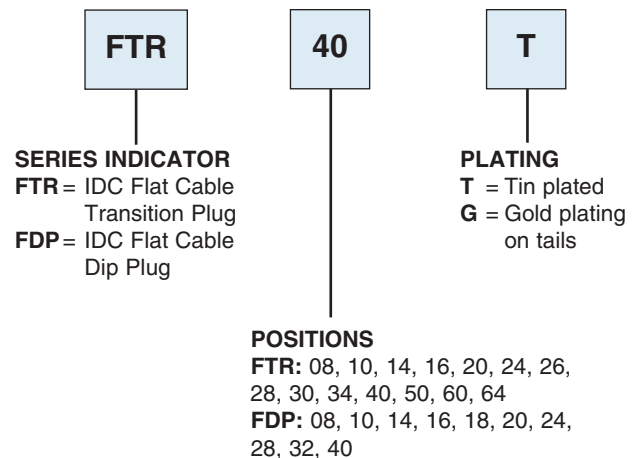

OPTIONS:

Add designator(s) to end of part number

30 = 30 μin gold plating in contact area

GY = Gray color insulator

RT = Board retention

RC = RoHS compliant lead-free product with Hi-Temp insulator

FTR .100" X .100" (8-20)

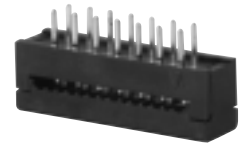
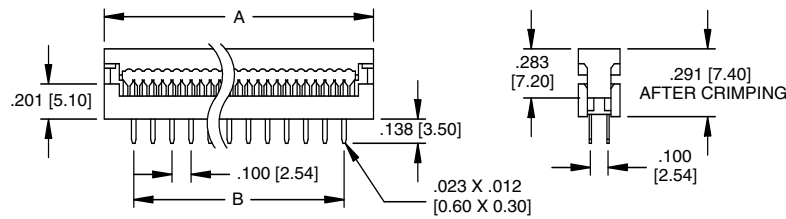
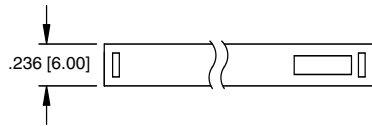

FTR-14-T

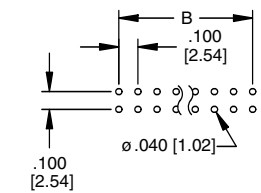

Recommended PCB Layout

FDP .100" X .300" (8-20)

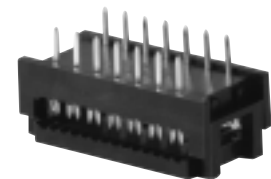
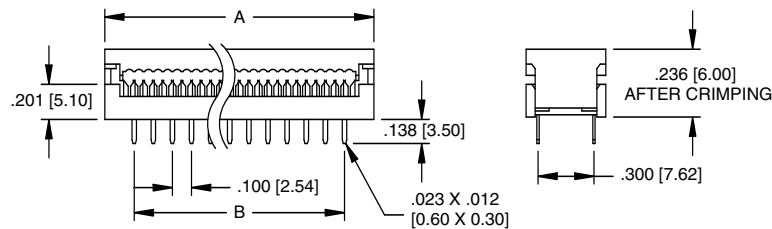
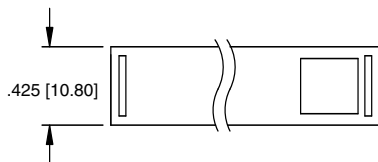

FDP-14-T

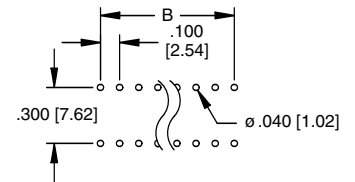

Recommended PCB Layout

FDP .100" X .600" (24-40)

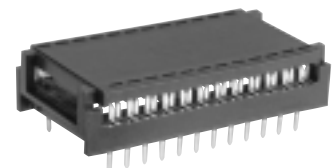
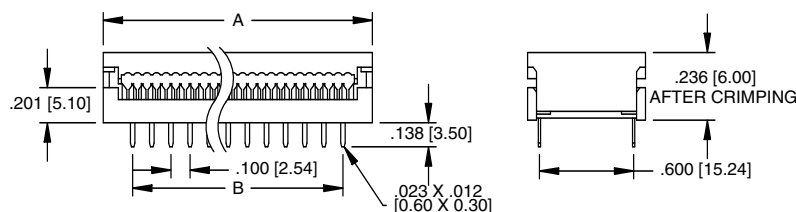
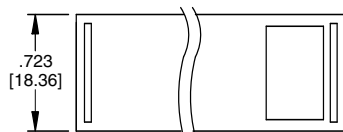

FDP-24-T

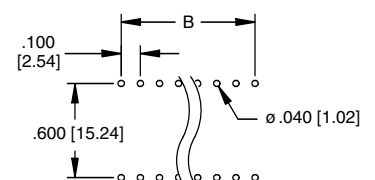

Recommended PCB Layout