



# Solutions for AdvancedTCA, AdvancedTCA 300, MicroTCA, and AdvancedMC Standards

RoHS  
Ready 

 **Tyco Electronics**  
Our commitment. Your advantage.

## Introduction

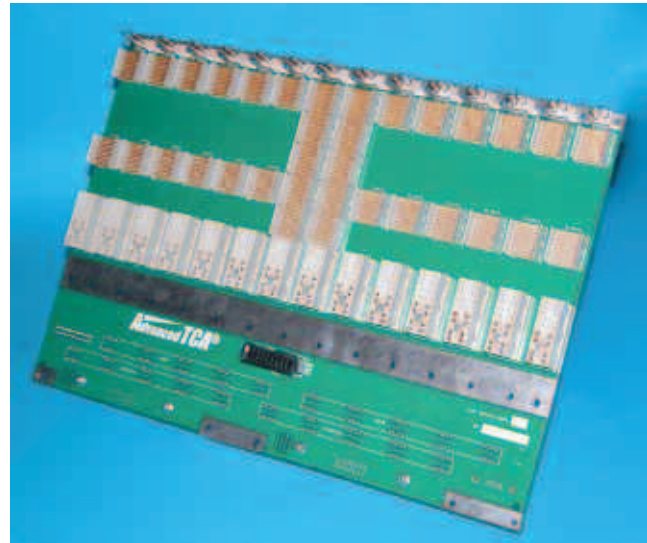

### Need more information?

Call Technical Support at the numbers listed below.

Technical Support is staffed with specialists well versed in all Tyco Electronics products. They can provide you with:

- Technical Support
- Catalogs
- Technical Documents
- Product Samples
- Tyco Electronics Authorized Distributor Locations

AdvancedMC, AdvancedTCA, AdvancedTCA 300, MicroTCA and PICMG are trademarks of PICMG-PCI Industrial Computer Manufacturers Group Incorporated.

### Solutions For AdvancedTCA

Hardware designers, particularly those working on blades or chassis, are currently faced with huge challenges. The needs of the communications network infrastructure and next generation communication applications are rapidly changing, and cannot be served by existing proprietary solutions.

Therefore AdvancedTCA (Advanced Telecommunications Computing Architecture), MicroTCA (Micro Telecommunications Computing Architecture) and AdvancedMC (Advanced Mezzanine Card) open industry standards have been developed by PICMG to place a high priority on cost effectiveness while attempting to support a variety of potential future technologies.

This new standard is also supported by Tyco Electronics, which shows the full range of AdvancedTCA, MicroTCA and AdvancedMC compliant components that can be offered for the wide area of applications within telecommunication as well as data communication.

### Why are AdvancedTCA and MicroTCA Standards Important?

AdvancedTCA and MicroTCA provide a means for the telecommunications equipment market to take advantage of standardized, off-the-shelf hardware (enabling differentiation through application-layer and system-level software rather than hardware).

- Shorter time to market
- Increased vendor choice
- Increased flexibility
- Multiple switch fabrics supported
- User defined I/O
- Lower cost (Acquisition CapEx/OpEx)

### Examples of Telecom & Network Equipment Manufacturers' Related AdvancedTCA and MicroTCA Applications & Systems

#### Wireless Infrastructure Equipment

- Base Stations  
3G (IMT-2000)  
WCDMA  
CDMA2000  
TD-SCDMA

- Radio Network Controllers (RNC)
- Serving Gateway Support Node (SGSN)
- Gateway GPRS Support Node (GGSN)
- Home Location Register (HLR)
- IP Multimedia Subsystem (IMS) Servers
- Media and Application Servers
- Media Gateways and Soft Switches

#### Wireline Networking Equipment

- DSLAMs
- Multi-service switches
- Media servers
- Blade servers
- VOIP Session Controllers

#### Fiber Optic Networking Equipment



## Introduction (Continued)



### What Is AdvancedTCA?

AdvancedTCA is an open industry standard, developed by PICMG 3.0, to create a new blade (board) and chassis (shelf) form factor, tailored to meet the needs of the rapidly changing communications network infrastructure, and next generation communication applications, which cannot be served by existing proprietary solutions. This architecture places high priority on cost effectiveness versus attempting to support a variety of potential future technologies.

While the specification is founded on the requirements of the communications infrastructure, it is extensible to a variety of applications and environments where highly available, highly scalable, cost effective and open architecture modular solutions are required.

The architecture is optimized around connectivity requirements of signaling and media gateways, while also providing headroom for higher performance computing elements @ a 99.999% availability rate. AdvancedTCA offers a scalable backplane environment that supports:

- A variety of standard and proprietary fabric interfaces
- Robust system management
- Superior power and cooling capabilities.

Each board in AdvancedTCA (up to 16 boards a shelf and 3 shelves a rack) may support up to 200 W in a single slot. The power is supplied to each board via redundant -48 VDC feeds. Front and rear cabling practice is supported for standard 600 mm total depth cabinet practice, prevalent in Central Office facilities.



### What Is AdvancedTCA300?

AdvancedTCA300 is an AdvancedTCA based equipment platform, but compliant with the ANSI and ETSI equipment practices requiring 300 mm total depth, front access included.



### What Is AdvancedMC?

The AdvancedMC standard, also developed by PICMG, defines the base-level requirements for a wide-range of high-speed mezzanine cards, optimized for, but not limited to, AdvancedTCA and MicroTCA carrier blades. AdvancedMC defines a modular add-on or "child" card that extends the functionality of an AdvancedTCA carrier board. In an AdvancedTCA equipment practice, the AdvancedMC modules lie parallel to and are integrated onto the AdvancedTCA carrier board. The AdvancedMC cards can also be equipped in MicroTCA shelves.



### What Is MicroTCA?

MicroTCA is complementary to AdvancedTCA, but is optimized for smaller scale and more price sensitive applications. The basic premise of MicroTCA is to support mezzanine boards, conform to the AdvancedMC standard, and connect to the backplane, eliminating the need to use an additional carrier board. Like AdvancedTCA, the MicroTCA equipment practice is a modular, open standards based shelf level platform. The MicroTCA standard has not finished completion yet.

AdvancedMC, AdvancedTCA, AdvancedTCA 300, MicroTCA and PICMG are trademarks of PICMG-PCI Industrial Computer Manufacturers Group Incorporated.

[www.tycoelectronics.com/products/atca](http://www.tycoelectronics.com/products/atca)

## Table of Contents

<b>Introduction to AdvancedTCA, MicroTCA, and AdvancedMC Standards</b> .....	2, 3
<b>Product Defined in AdvancedTCA/AdvancedTCA 300 Specifications</b>	
AdvancedTCA — Zone 1 Power Connectors .....	5, 6
AdvancedTCA — Zone 2 Z-PACK HM-Zd High Speed Signal Connectors .....	7-9
AdvancedTCA — Zone 3 RTM Board Connector .....	10
Co-Planar UPM for AdvancedTCA Zone 3 Power Applications .....	11
Z-PACK TinMan Connectors for AdvancedTCA Standards — Zone 3 .....	12
AdvancedTCA — Advanced Mezzanine Card (AdvancedMC) Connectors .....	13
MULTI-BEAM XL Connectors for AdvancedTCA 300 Standard .....	14
AdvancedTCA — Guide Modules .....	15
<b>Product Defined in MicroTCA Specification</b>	
Vertical AdvancedMC Connector for MicroTCA Applications .....	16
MINIPAK HD Power Connectors .....	17-19
<b>Product Compliant to xTCA or AdvancedMC Specifications</b>	
Stacked RJ45 Modular Jacks for AdvancedTCA, AdvancedMC Standards .....	20
Low Profile RJ45 Modular Jacks .....	21
AdvancedTCA — Front & Rear I/O Connectors – SFP Modules .....	22
AdvancedTCA — Front & Rear I/O Connectors — MRJ21 Receptacles .....	23
AdvancedTCA — Thermal Products & Services .....	23
Low Profile DDR2 Connector for AdvancedTCA Standards .....	24
SO DIMM Connectors for AdvancedMC Applications .....	25
1.0 mm Free Height (FH) (IEEE 1386) Connectors .....	26
AdvancedTCA — Power Distribution & Management Modules .....	27, 28
<b>Part Number Index</b> .....	29
<b>Web Site Information</b> .....	30
<b>Global Contacts</b> .....	31

© Copyright 2007, 2006 and 2005 by Tyco Electronics Corporation. All International Rights Reserved.

AMP, Austin Lynx, CHIP COOLER, ELCON, FUTUREBUS+, MINIPAK, MRJ21, MULTI-BEAM XL, TE Logo, Tyco Electronics, Z-PACK and Z-PACK TinMan are trademarks.

AdvancedMC, AdvancedTCA, AdvancedTCA 300, MicroTCA and PICMG are trademarks of PICMG-PCI Industrial Computer Manufacturers Group Incorporated.

Infiniband is a trademark of Infiniband Trade Association.

Other products, logos, and company names mentioned herein may be trademarks of their respective owners.

### Disclaimer

While Tyco Electronics Corporation and its affiliates referenced herein ("Tyco Electronics") have made every reasonable effort to ensure the accuracy of the information in this catalog, Tyco Electronics does not guarantee that it is error-free, nor does Tyco Electronics make any other representation, warranty or guarantee that the information is accurate, correct, reliable or current. Tyco Electronics reserves the right to make any adjustments to the information contained herein at any time without notice. Tyco Electronics expressly disclaims all implied warranties regarding the information contained herein, including, but not limited to, any implied warranties of merchantability or fitness for a particular purpose. Tyco Electronics' only obligations are those in the Tyco Electronics Standard Terms and Conditions of Sale, and in no case will Tyco Electronics be responsible for any incidental, indirect, or consequential damages arising from the sale, resale, use, or misuse of its products. Users should independently evaluate the suitability of, and test each product for, their application.

The dimensions, specifications, designs, construction, materials and processes in this catalog are for reference purposes only and are subject to change without notice. Please consult Tyco Electronics for the most current product information.

The export of certain Tyco Electronics products is restricted by the Arms Export Control Act (Title 22, U.S.C. Sec 2751, et seq.) or the Export Administration Act of 1979, as amended (Title 50, U.S.C., App. 2401 et seq.). Orders may be subject to export approval by the U.S. Government. Buyer must comply with all applicable export laws of all applicable jurisdictions.

**See inside back cover for Global Contacts and phone numbers.**

### Restriction on the use of Hazardous Substances (RoHS)

At Tyco Electronics, we're ready to support your RoHS requirements. We've assessed more than 1.5 million end items/components for RoHS compliance, and issued new part numbers where any change was required to eliminate the restricted materials. Part numbers in this catalog are identified as:

**RoHS Compliant** — Part numbers in this catalog are RoHS Compliant, unless marked otherwise. These products comply with European Union Directive 2002/95/EC as amended 1 January 2006 that restricts the use of lead, mercury, cadmium, hexavalent chromium, PBB, and PBDE in certain electrical and electronic products sold into the EU as of 1 July 2006.

NOTE: For purposes of this Catalog, included within the definition of RoHS Compliant are products that are clearly "Out of Scope" of the RoHS Directive such as hand tools and other non-electrical accessories.

**5 of 6 Compliant** — A "●" symbol identifies these part numbers. These products do not fully comply with the European Union Directive 2002/95/EC because they contain lead in solderable interfaces (they do not contain any of the other five restricted substances above allowable limits). However, these products may be suitable for use in RoHS applications where there is an application-based exception for lead in solders, such as the server, storage, or networking infrastructure exemption.

NOTE: Information regarding RoHS compliance is provided based on reasonable inquiry of our suppliers and represents our current actual knowledge based on the information provided by our suppliers. This information is subject to change. For latest compliance status, refer to our website referenced at right.

### Getting the Information You Need

Our comprehensive on-line RoHS Customer Support Center provides a forum to answer your questions and support your RoHS needs. A RoHS FAQ (Frequently Asked Questions) is available with links to more detailed information. You can also submit RoHS questions and receive a response within 24 hours during a normal work week. The Support Center also provides:

- Cross-Reference from Non-compliant to Compliant Products
- Ability to browse RoHS Compliant Products in our on-line catalog
- Downloadable Technical Data Customer Information Presentation
- More detailed information regarding the definitions used above
- So whatever your questions when it comes to RoHS, we've got the answers at [www.tycoelectronics.com/leadfree](http://www.tycoelectronics.com/leadfree)

**RoHS**  
Customer  
Support  
Center 

## Product Defined in AdvancedTCA/AdvancedTCA 300 Specifications

### AdvancedTCA — Zone 1 Power Connectors

Tyco Electronics' AdvancedTCA Power Connector is designed to meet or exceed the PICMG 3.0, R2.0 (AdvancedTCA) specification for Zone 1 connector requirements including four levels of sequential mating to provide proper system functionality during live insertion or extraction of front boards. Integrated lead-in on the injection molded housing provides superior blind mate capability and is fully intermateable with competing connectors designed to meet the AdvancedTCA specification for power connectors.

[www.tycoelectronics.com/products/atca](http://www.tycoelectronics.com/products/atca)  
[www.elconproducts.com](http://www.elconproducts.com)

Catalog 1773096 / 1773095  
Flyer 2-1773441-7

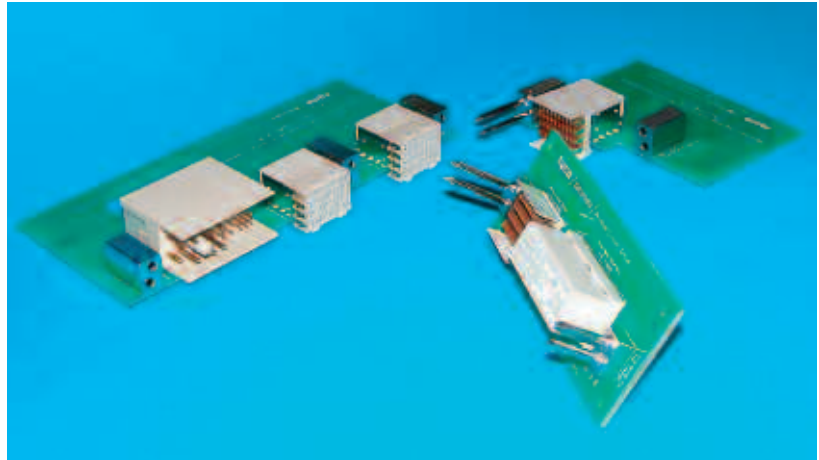

#### FEATURES:

- High conductivity, precision formed contacts
- Selective plating in compliance with RoHS requirements
- Precision formed compliant terminations offer excellent retention to provide a reliable connection
- Qualified to meet PICMG 3.0, R2.0 specification

### AdvancedTCA Zone 1 Connector

**Front Board Connector**  
**Right Angle Header**  
**Part Number 1766500-1**

**Backplane Connector**  
**Vertical Receptacle**  
**Part Number 1766501-1**



Backplane Connector



Daughtercard Connector

AdvancedMC, AdvancedTCA, AdvancedTCA 300, MicroTCA and PICMG are trademarks of PICMG-PCI Industrial Computer Manufacturers Group Incorporated.

**Note:** Part Numbers are RoHS compliant.

**Product Defined in AdvancedTCA/AdvancedTCA 300 Specifications** (Continued)

**AdvancedTCA Zone 1 Connector**

(Continued)

**Front Board Connector**  
**Right Angle, Compliant Press-fit**  
**Part Number 1766500-1**  
 (tin plated pcb tails)  
**Part Number 1766500-2**  
 (tin-lead pcb tails)

**Right Angle Plug, 22-Position, Compliant Press-fit**  
**Part Number 1766502-1**  
 (tin plated pcb tails)  
**Part Number 1766502-2**  
 (tin-lead pcb tails)

**Material and Finish**

**Insulators** — Thermoplastic, glass reinforced, black, UL94V-0  
**Signal Pins** — Copper alloy  
**Power Contacts** — High conductivity copper alloy, plated 0.00076 [0.00030] min. gold in mating area  
**Solder Tails** — 0.0030 - 0.0043 [0.00120 - .000170] tin plated

**Notes:**

1. Mounting Holes ( $\varnothing$ 2.00 [0.079] x 5.00 [0.197] DP) for use with self tapping screw (customer supplied).
2. Positions 1-4 not populated and reserved for future use.

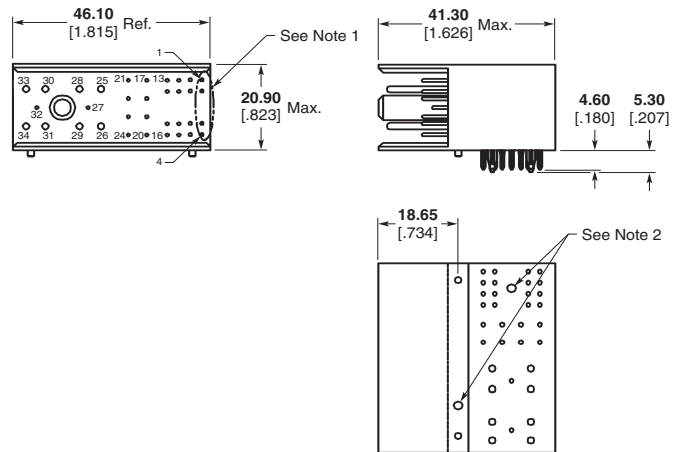

**Backplane Connector**  
**Straight, Compliant Press-fit,**  
**Part Number 1766501-1**  
 (tin plated pcb tails)  
**Part Number 1766501-2**  
 (tin-lead pcb tails)

**Straight, 22-Position, Compliant Press-fit**  
**Part Number 1766503-1**  
 (tin plated pcb tails)  
**Part Number 1766503-2**  
 (tin-lead pcb tails)

**Material and Finish**

**Insulators** — Thermoplastic, glass reinforced, black, UL94V-0  
**Signal Pins** — Copper alloy  
**Power Contacts** — High conductivity copper alloy, plated 0.0076 [0.00030] min. gold in mating area  
**Solder tails** — 0.0030 - 0.0043 [0.00120 - .000170] tin plated

**Notes:**

1. Mounting Holes ( $\varnothing$ 2.00 [0.079] x 5.00 [0.197] DP) for use with self tapping screw (customer supplied).
2. Positions 1-4 not populated and reserved for future use.

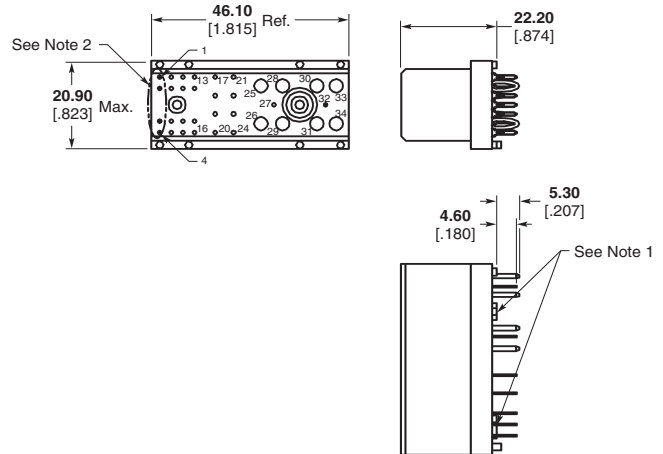

AdvancedMC, AdvancedTCA, AdvancedTCA 300, MicroTCA and PICMG are trademarks of PICMG-PCI Industrial Computer Manufacturers Group Incorporated.

**Note:** Part Numbers are RoHS compliant except: ● Indicates "5 of 6 compliant" (lead in solderable interface only).



**Product Defined in AdvancedTCA/AdvancedTCA 300 Specifications** (Continued)

**AdvancedTCA — Zone 2 Z-PACK HM-Zd High Speed Signal Connectors**

Z-PACK HM-Zd product from Tyco Electronics is the high-speed, Advanced Differential Fabric Connector system specified by PICMG for use in AdvancedTCA Zone 2. The coplanar application version using the right angled male and identical Zone 2 card connector (right angled female), can be used in Zone 3. In addition to the four-pair connector modules specified for use in AdvancedTCA Zone 2, the product line includes two-pair and three-pair signal modules, coplanar connectors, and high-speed cable assemblies for use in Zone 3. A mezzanine style connector is also available in a four-pair version.

[www.tycoelectronics.com/products/atca](http://www.tycoelectronics.com/products/atca)  
[www.hmzd.tycoelectronics.com](http://www.hmzd.tycoelectronics.com)

**Catalog 1773095**  
**Flyer 1308658**

**FEATURES**

- Designed specifically for high-speed differential applications (3.125 Gb/s to 10+Gb/s)
- A modular connector system with a standard module size of 25.00 [.984]
- Z-PACK HM-Zd product is an extension of the Z-PACK 2 mm HM product line
- Pin header and receptacle have the exact same footprint to simplify PC board layout
- Optimized footprint supports quad routing techniques for improved electrical performance, ease of trace routing, and significant PCB manufacturing cost reductions
- Designed to meet Telcordia requirements

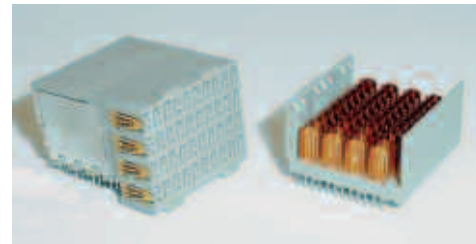
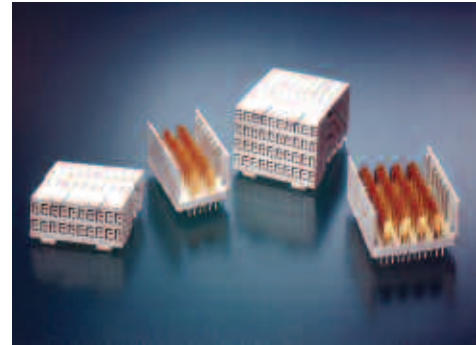

**AdvancedTCA Zone 2 Z-PACK HM-Zd High Speed Signal Connectors**

**Front Board Connector**  
**4 Pair Right Angle Receptacle**  
**Part Number 6469001-1**

**Backplane Connector**  
**4 Pair Vertical Header**  
**Part Number 6469002-1**

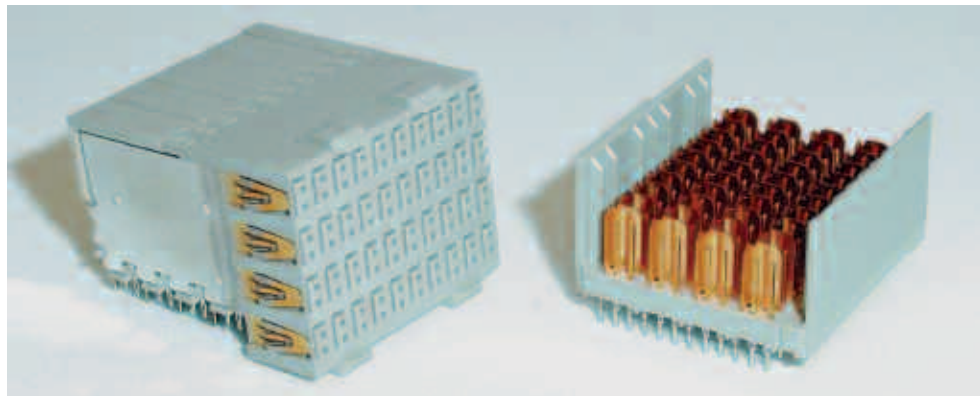

Front Board Connector

Backplane Connector

AdvancedMC, AdvancedTCA, AdvancedTCA 300, MicroTCA and PICMG are trademarks of PICMG-PCI Industrial Computer Manufacturers Group Incorporated.

**Note:** Part Numbers are RoHS compliant.

**Product Defined in AdvancedTCA/AdvancedTCA 300 Specifications** (Continued)

**AdvancedTCA Zone 2  
Z-PACK HM-Zd High Speed  
Signal Connectors** (Continued)

**4 Pair Right Angle  
Receptacle Assemblies**

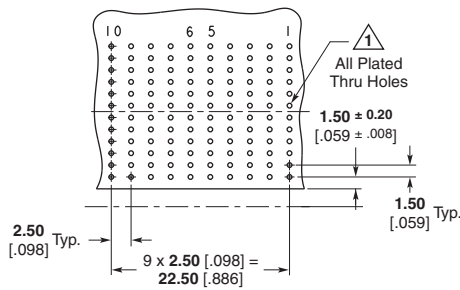
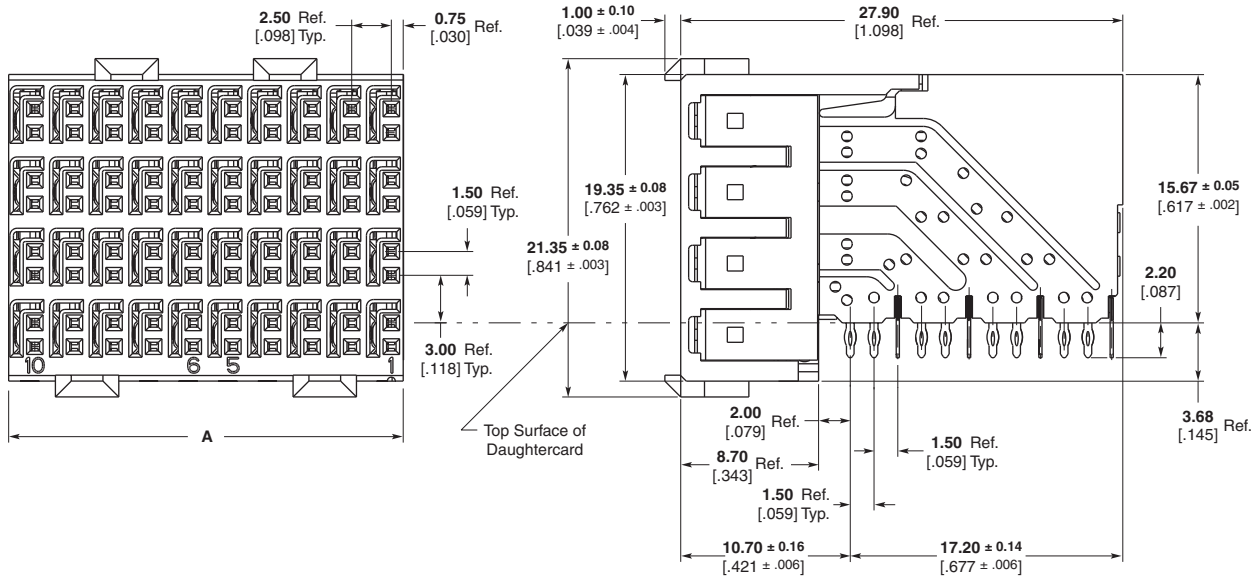

- △ PCB Hole Dim.  
 Drilled Hole =  $0.7000 \pm 0.025$  [.02756 ± .0010]  
 Finished Hole =  $0.60 \pm 0.05$  [.024 ± .002]  
 Cu Thickness =  $0.375 \pm 0.0125$  [.0148 ± .00049]  
 SnPb Thickness =  $0.007 \pm 0.003$  [.0003 ± .0001]

**Note:** For finishes other than tin-lead, reference Application Specification 114-13059.

**Recommended PC Board Layout  
Daughter Board, Component Side Shown**

Part Number	Column Count	Module Length (Dim. A)	Signals	Grounds	Application Tooling		
					Insertion	Repair	
					Receptacle	Housing Removal	Chiclet Removal
6469001-1 <sup>1</sup>	10	25.00 .984	80	40	91347-1	1583224-1	1583248-1
6469286-1	12	30.00 1.181	96	48	91347-3	1583224-2	1583248-1
6469294-1	15	37.50 1.476	120	60	91347-2	1583224-3	1583248-1
6469061-1	20	50.00 1.969	160	80	91347-4	1583224-4	1583248-1

<sup>1</sup> AdvancedTCA Zone 2 Daughtercard Connector.  
**Note:** Part Numbers are RoHS compliant.

AdvancedMC, AdvancedTCA, AdvancedTCA 300, MicroTCA and PICMG are trademarks of PICMG-PCI Industrial Computer Manufacturers Group Incorporated.



**Product Defined in AdvancedTCA/AdvancedTCA 300 Specifications (Continued)**

**AdvancedTCA Zone 2 Z-PACK HM-Zd High Speed Signal Connectors (Continued)**

**4 Pair Vertical Pin Header Assemblies**

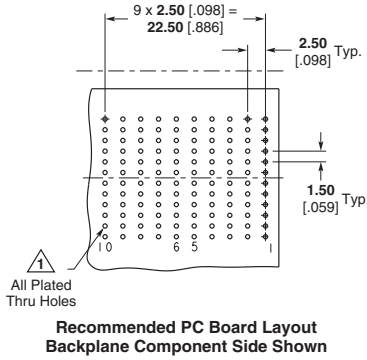
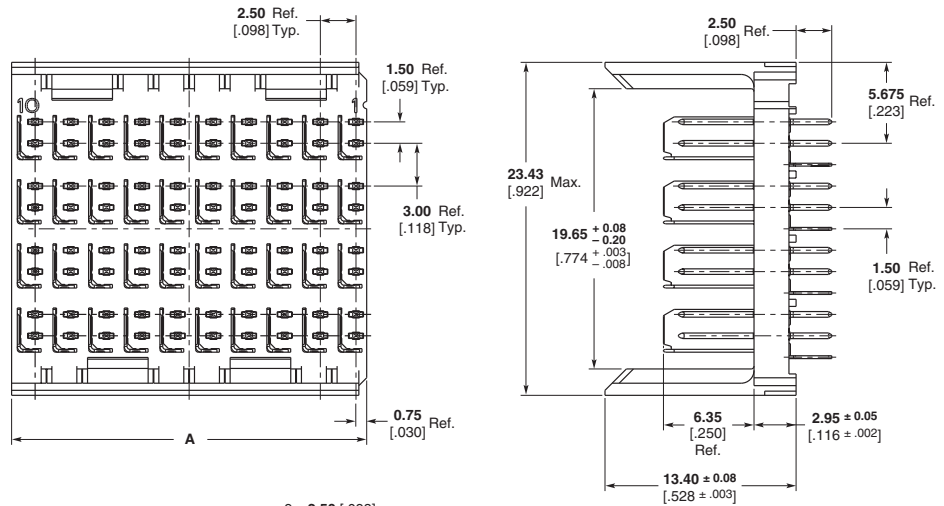

PCB Hole Dim.  
 Drilled Hole =  $0.7000 \pm 0.0025$  [.02756 ± .0010]  
 Finished Hole =  $0.60 \pm 0.05$  [.024 ± .002]  
 Cu Thickness =  $0.375 \pm 0.0125$  [.0148 ± .00049]  
 SnPb Thickness =  $0.007 \pm 0.003$  [.0003 ± .0001]

**Note:** For finishes other than tin-lead, reference Application Specification 114-13059.

Part Number	Tail Length	Mating Pin Length	Column Count	Module Length (Dim. A)	Signals	Grounds	Application Tooling			
							Insertion Pin Header	Pin Removal	Repair Housing Removal	Pin Insertion
6469002-1 <sup>1</sup>	2.50 .098	5.30 .209	10	25.00 .984	80	40	91349-1	1583237-1	1583220-1	1583255-1
6469046-1 <sup>2</sup>	2.50 .098	5.30 .209	10	25.00 .984	80	40	91349-1	1583237-1	1583220-1	1583255-1
6469074-1	1.80 .071	5.30 .209	10	25.00 .984	80	40	91349-1	1583237-1	1583220-1	1583255-1
6469287-1	2.50 .098	5.30 .209	12	30.00 1.181	96	48	91349-3	1583237-1	1583220-1	1583255-1
6469296-1	2.50 .098	5.30 .209	15	37.50 1.476	120	60	91349-2	1583237-1	1583220-1	1583255-1
6469062-1	2.50 .098	5.30 .209	20	50.00 1.969	160	80	91349-4	1583237-1	1583220-1	1583255-1
6469099-1	1.80 .071	5.30 .209	20	50.00 1.969	160	80	91349-4	1583237-1	1583220-1	1583255-1

<sup>1</sup> AdvancedTCA Zone 2 Backplane Connector.  
<sup>2</sup> Shallow Wall for Daughtercards thicker than 3.50 [.138].  
**Note:** Part Numbers are RoHS compliant.

AdvancedMC, AdvancedTCA, AdvancedTCA 300, MicroTCA and PICMG are trademarks of PICMG-PCI Industrial Computer Manufacturers Group Incorporated.

**Product Defined in AdvancedTCA/AdvancedTCA 300 Specifications (Continued)**

**Z-PACK HM-Zd RTM Board Connector for AdvancedTCA Zone 3 Standard**

**AdvancedTCA Zone 3  
Z-PACK HM-Zd  
High Speed, Co-Planar  
RTM Board Connector**  
4 Pair Right Angle Header  
Part Number 6469048-1  
Part Number 6469375-1  
Front Board Connector  
4 Pair Right Angle  
Receptacle  
Part Number 6469001-1  
(see page 8)

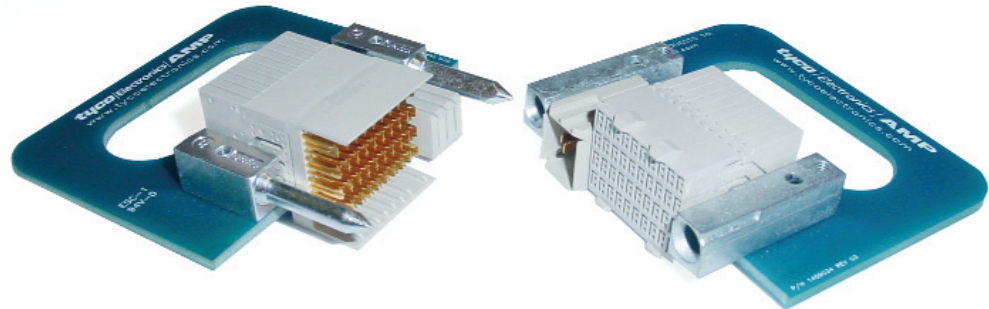

**4 Pair Right Angle  
Pin Header Assemblies**

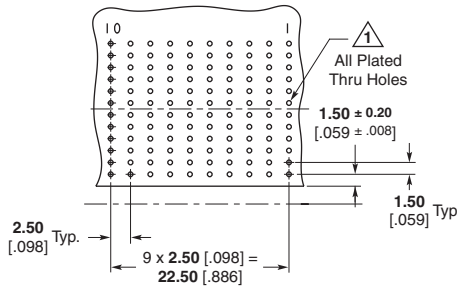
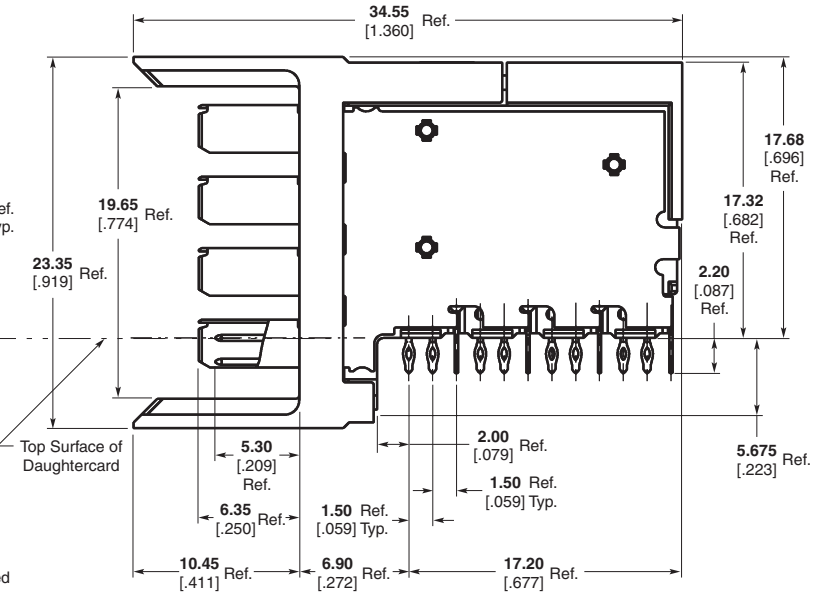
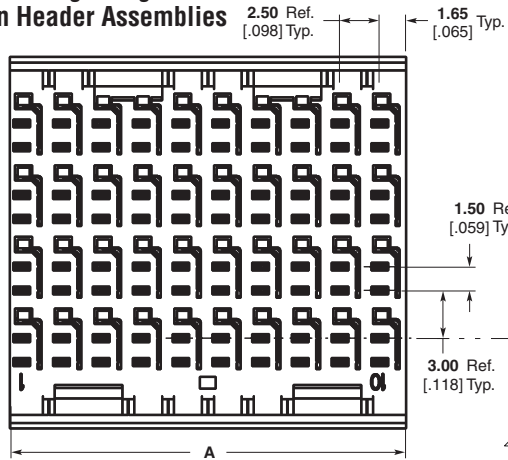

**Recommended PC Board Layout  
Component Side Shown**

⚠ PCB Hole Dim.  
Drilled Hole =  $0.7000 \pm 0.025$  [.02756 ± .0010]  
Finished Hole =  $0.60 \pm 0.05$  [.024 ± .002]  
Cu Thickness =  $0.375 \pm 0.0125$  [.0148 ± .00049]  
SnPb Thickness =  $0.007 \pm 0.003$  [.0003 ± .0001]

**Note:** For finishes other than tin-lead, reference Application Specification 114-13059.

Part Number	Tail Length	Mating Pin Length	Column Count	Module Length (Dim. A)	Signals	Grounds	Application Tooling		
							Insertion Pin Header	Housing Removal	Repair Chiclet Removal
6469048-1	2.20 .087	5.30 .209	10	25.00 .984	80	40	91378-1	1804174-1	1804177-1
6469375-1	2.20 .087	5.30 .209	12	30.00 1.181	96	48	91378-3	1804174-1	1804177-1

**Note:** Part Numbers are RoHS compliant.

AdvancedMC, AdvancedTCA, AdvancedTCA 300, MicroTCA and PICMG are trademarks of PICMG-PCI Industrial Computer Manufacturers Group Incorporated.

**Product Defined in AdvancedTCA/AdvancedTCA 300 Specifications** (Continued)

**Co-Planar UPM for AdvancedTCA Zone 3 Power Applications**

The Co-Planar Universal Power Module (UPM) is specifically designed to meet the need of connecting two printed circuit boards on the same plane. The UPM connector features hot-pluggable, 16 Amp power industry proven contacts and have three sequencing levels.



**FEATURES**

- Hot-Pluggable contact design
- 16 Amp per contact (on 4-position)
- 250 cycle durability
- Touch-safe receptacle

**Right Angle Receptacle**

No. of Circuit Positions	Right-Angle High Power 16 Amps/ Contact Part Numbers
3	120943-1
4	120943-2
5	120943-3
6	120943-4
7	120943-5
8	120943-6
9	120943-7

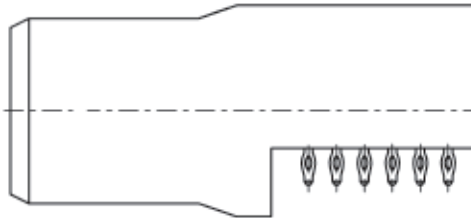

**Right Angle Plug**

Number of Positions	Dimension L	High Power 16 Amps/ Contact Sequence* Pattern	Part Number
3	12.00 .472	M,M,M	5-5223961-1
		M,L,M	5-5223963-1
		**	**
4	15.00 .591	L,L,L,L	120954-1
		L,M,S,S	120954-2
		**	**
5	18.00 .709	L,L,L,L,L	120955-1
		M,M,L,M,M	120955-2
		**	**
6	21.00 .827	L,L,L,L,L,L	120956-1
		L,M,S,S,S,S	120956-2
		**	**
7	24.00 .945	L,L,L,L,L,L,L	120957-1
		L,S,S,L,S,S,L	120957-2
		**	**
8	27.00 1.063	L,L,L,L,L,L,L,L	120958-1
		L,M,S,S,S,S,S,S	120958-2
		**	**

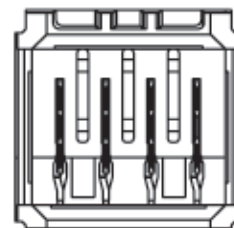
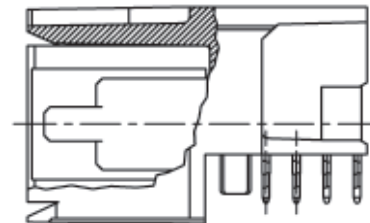

\*Sequencing Reads left-to-right along mating face.  
L (long) = 10.90 [.429], M (medium) = 9.30 [.366], S [short] = 7.68 [.302]  
\*\*Other sequence patterns available. See on-line customer drawing.

AdvancedMC, AdvancedTCA, AdvancedTCA 300, MicroTCA and PICMG are trademarks of PICMG-PCI Industrial Computer Manufacturers Group Incorporated.

**Note:** Part Numbers are RoHS compliant.



**Product Defined in AdvancedTCA/AdvancedTCA 300 Specifications** (Continued)

**Z-PACK TinMan Connectors for AdvancedTCA Standards — Zone 3**

Tyco Electronics Z-PACK TinMan product is a new high speed, 100-Ohm Impedance matched connector with extreme signal density. This connector can be pinned out for lower speed signal ended lines and exists in 3, 4, and 5 pair per column versions.

**FEATURES:**

- High speed: +10 Gbps
- High Density: 25 pair/cm [66 pairs/in]
- 3, 4, and 5 pair per column versions (5 pair shown)
- Available with or without end walls for pin protection
- Designed to meet Telcordia requirements

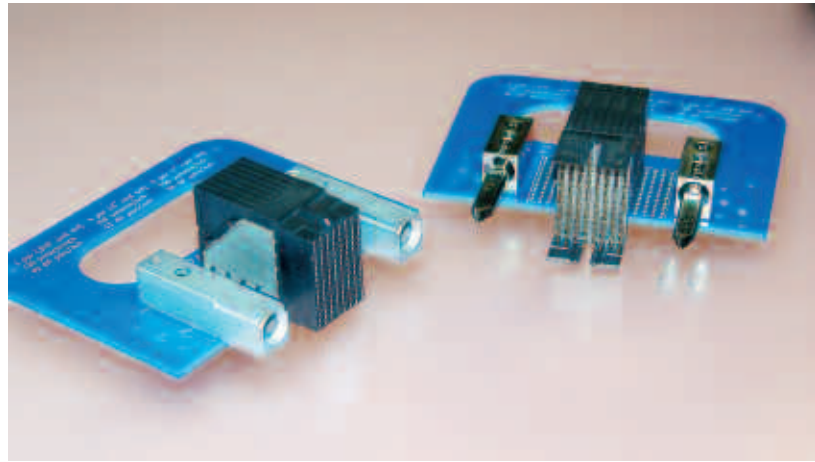

**Z-PACK TinMan Receptacles**

No. of Pairs	Columns	Part Number	Dimensions	
			Length	Width
3	8	1934226-1	31.81 1.25	15.35 .604
	16	1934229-1	31.81 1.25	30.55 1.203
4	8	1934222-1	31.81 1.25	15.35 .604
	16	1934225-1	31.81 1.25	30.55 1.203
5	8	1934218-1	31.81 1.25	15.35 .604
	16	1934221-1	31.81 1.25	30.55 1.203

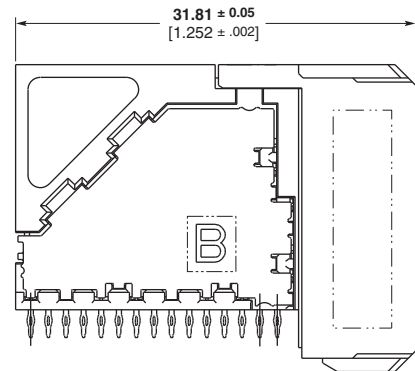
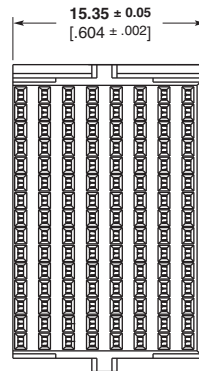

**Z-PACK TinMan Headers**

No. of Pairs	Columns	Part Number	Dimensions		End Walls
			Length	Width	
3	8	1469974-1	31.81 1.25	15.35 .604	N
		1469977-1	31.81 1.25	18.05 .710	Y
	16	1934034-1	31.81 1.25	30.55 1.203	N
		1934037-1	31.81 1.25	33.25 1.31	Y
4	8	1469793-1	31.81 1.25	15.35 .604	N
		1469795-1	31.81 1.25	18.05 .710	Y
	16	1934026-1	31.81 1.25	30.55 1.203	N
		1934029-1	31.81 1.25	33.25 1.31	Y
5	8	1469735-1	31.81 1.25	15.35 .604	N
		1469737-1	31.81 1.25	18.05 .710	Y
	16	1934018-1	31.81 1.25	30.55 1.203	N
		1934021-1	31.81 1.25	33.25 1.31	Y

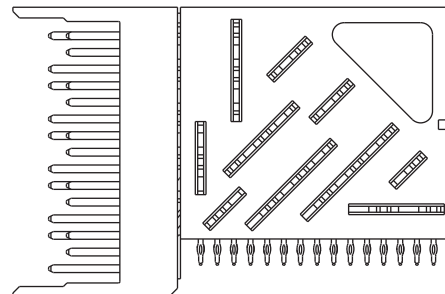
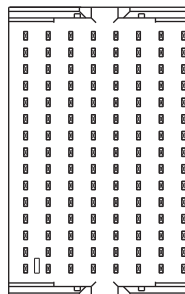

AdvancedMC, AdvancedTCA, AdvancedTCA 300, MicroTCA and PICMG are trademarks of PICMG-PCI Industrial Computer Manufacturers Group Incorporated.

**Note:** Part Numbers are RoHS compliant.

Product Defined in AdvancedTCA/AdvancedTCA 300 Specifications

**Product Defined in AdvancedTCA/AdvancedTCA 300 Specifications** (Continued)

**AdvancedTCA — Advanced Mezzanine Card (AdvancedMC) Connectors**

Tyco Electronics is developing an AdvancedMC connector designed to meet the PICMG AdvancedMC specification for use with AdvancedTCA carrier boards and other related applications. The AdvancedMC product family from Tyco Electronics will include single-part Z-Pluggable connectors in Extended (B+ and A+B+) styles.

[www.tycoelectronics.com/products/atca](http://www.tycoelectronics.com/products/atca)

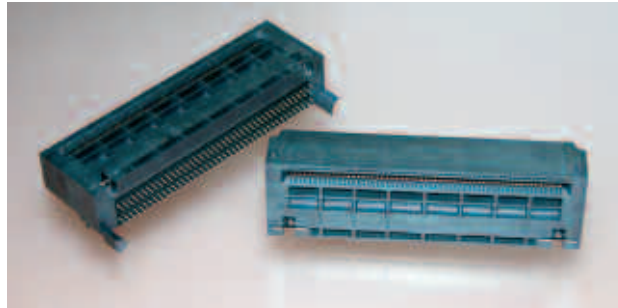

**Product Specification**  
108-2277

**Application Specification**  
114-13181

**FEATURES**

- B+ style available now
- A+B+ styles planned
  - Targeted for high-speed differential applications (3.125 Gb/s to 10+ Gb/s):
  - Precision formed compliant pin reduces stub effect and offers excellent retention to provide a reliable connect
- Suitable for assembly processes using flat-rock tooling

**AdvancedMC Connector, Style B+  
Part Number 1367703-X**

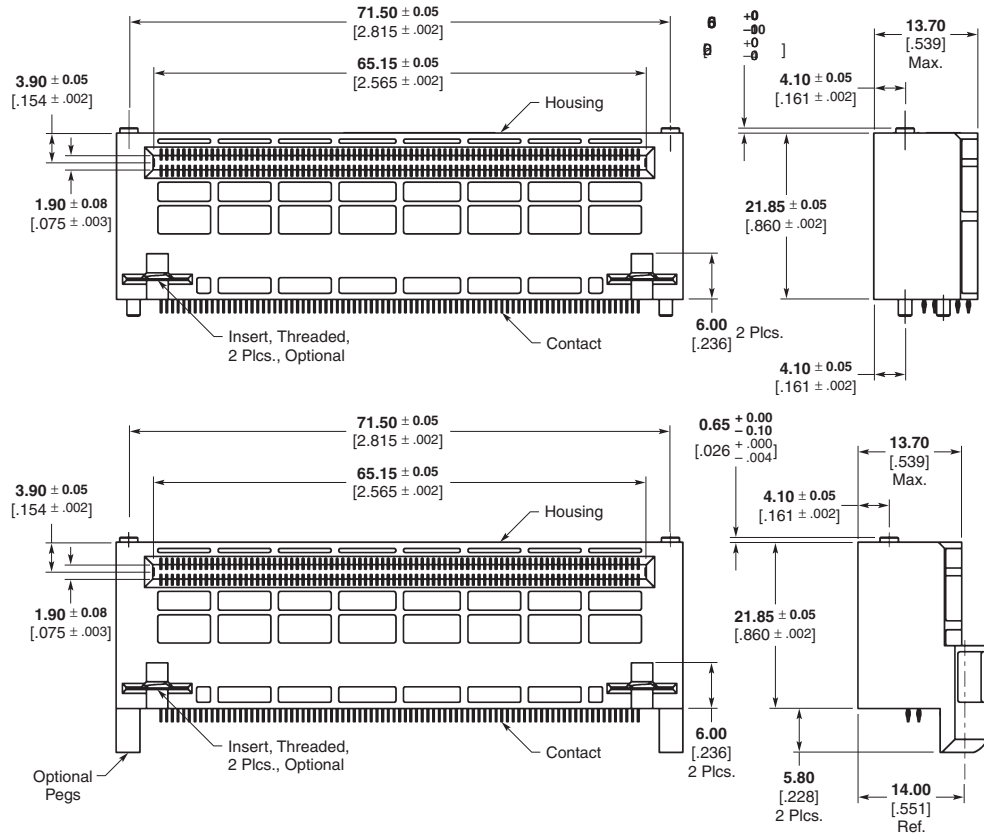

Part Number	Plating	Inserts	Pegs
1367703-1●	SnPb	No	No
1367703-2	Sn	No	No
1-1367703-1●	SnPb	Yes	No
1-1367703-2	Sn	Yes	No
2-1367703-1●	SnPb	No	Yes
2-1367703-2	Sn	No	Yes
3-1367703-1●	SnPb	Yes	Yes
3-1367703-2	Sn	Yes	Yes

**Note:** Part Numbers are RoHS compliant except: ● Indicates "5 of 6 compliant" (lead in solderable interface only).

AdvancedMC, AdvancedTCA, AdvancedTCA 300, MicroTCA and PICMG are trademarks of PICMG-PCI Industrial Computer Manufacturers Group Incorporated.

**Product Defined in AdvancedTCA/AdvancedTCA 300 Specifications** (Continued)

**MULTI-BEAM XL Connectors for AdvancedTCA 300 Standard**

MULTI-BEAM XL product has recently been specified as the Power Entry Module (PEM) connector for use in AdvancedTCA 300 applications. This new MULTI-BEAM XL connector is a blind-mateable board-to-board power distribution connection system that is designed to meet the AdvancedTCA 300 specification. This new addition to the Tyco Electronics MULTI-BEAM XL product line is selectively loaded and available with press-fit or solder tail termination styles.

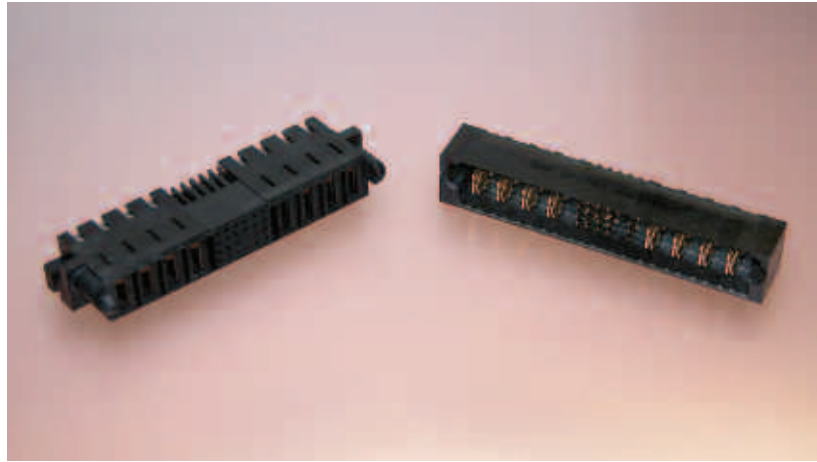

**FEATURES:**

- Meets the AdvancedTCA 300 Specification
- 55 Amp Single Power Contact, 4 Amp Single Signal Contact
- Solder or Press-Fit termination to PCB
- Specially sequenced for the AdvancedTCA Specification
- Custom configurable modular design

**Right Angle Receptacle**  
For use on PEM  
Part Number 1888765-1  
(Press-Fit Version)

**Vertical Plug**  
For use on backplane  
Part Number 1888766-1  
(Press-Fit Version)

**PEM Connector**

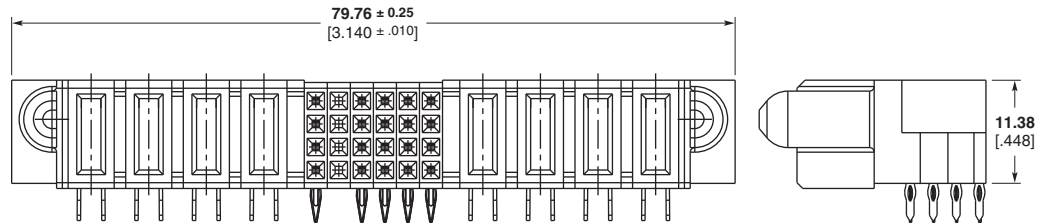

**Backplane Connectors**

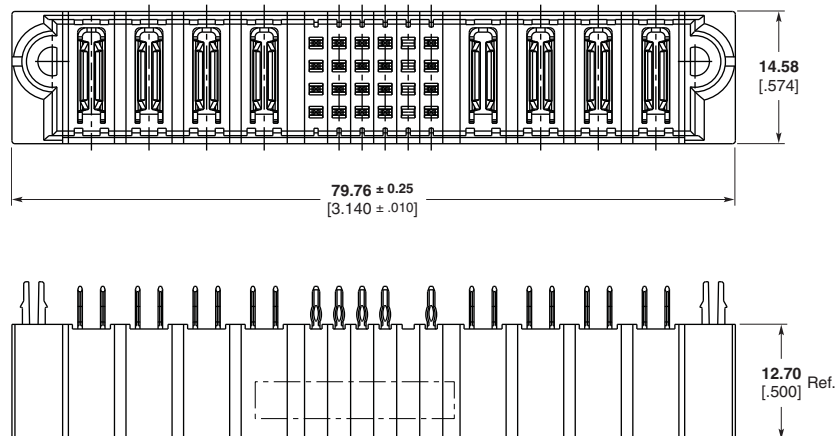

AdvancedMC, AdvancedTCA, AdvancedTCA 300, MicroTCA and PICMG are trademarks of PICMG-PCI Industrial Computer Manufacturers Group Incorporated.

**Note:** Part Numbers are RoHS compliant.

Product Defined in AdvancedTCA/  
AdvancedTCA 300 Specifications



**Product Defined in AdvancedTCA/AdvancedTCA 300 Specifications** (Continued)

**AdvancedTCA — Guide Modules**

Tyco Electronics AdvancedTCA Guide Modules are available in various sizes and configurations and are suitable for use in a wide variety of applications including front board, mid plane, backplane, and a Rear Transition Module as specified in the AdvancedTCA specification. The guide hardware features improved locating features to confirm guidance is maintained across all component tolerances while the dual-keyed pin configuration allows for many different keying possibilities.

[www.tycoelectronics.com/products/atca](http://www.tycoelectronics.com/products/atca)

Catalog 1773095

**FEATURES:**

- Configurations for front board and backplane as well as midplane and coplanar applications in the RTM
- Vertical and right angle pins to support right angle and coplanar board configurations
- Guide pins are available in short or long lengths to accommodate various Tyco Electronics connectors

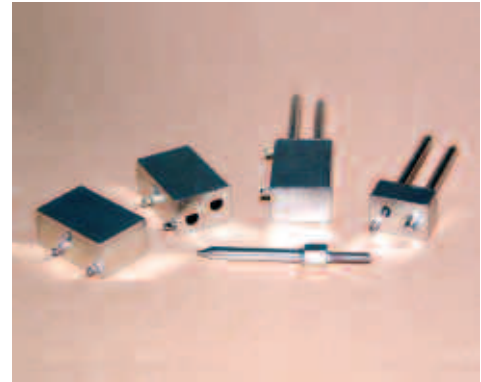

**AdvancedTCA Guide/Keying Modules**

The AdvancedTCA Guide Modules can be used in a wide variety of applications. For *motherboard-to-daughtercard applications* the vertical pin and right angle socket are used. This popular configuration is further supported by our wide offering of available keying positions. Each of the two keyed guide pins and guide sockets per module can be produced in a variety of different key positions. For *co-planar applications*, the right angle guide pins are used along with the right angle guide sockets. Both vertical and right angle guide pins are available in short or long sizes, to accommodate being used with different Tyco Electronics connectors.



rA1

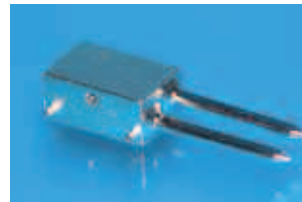

A2 (RTM)

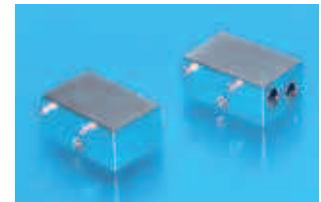

K1/K2



rK1



A1

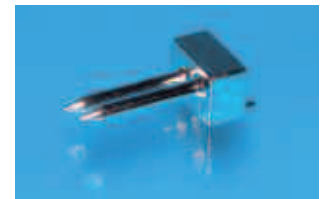

A2

AdvancedTCA Name	AdvancedTCA Location	Description	Part Number
rA1	Backplane	Rear Alignment Post 3.00 – 4.00 [.118 – .157] PCB Thickness	1469269-2
rA1	Backplane	Rear Alignment Post 4.10 – 6.00 [.161 – .236] PCB Thickness	1469269-4
rA1	Backplane	Rear Alignment Post 6.10 – 8.00 [.240 – .315] PCB Thickness	1469269-6
A2 (RTM)	Rear Transition Module	Right Angle Male, Keyed	1-1469372-1
K1/K2	Front Board	Right Angle Female, Keyed	1-1469373-1
K1/K2	Front Board	Right Angle Female, Unkeyed Dummy	9-1469373-9
rK1	Rear Transition	Right Angle Female	1469374-1
A1	Backplane	Vertical Male, Keyed, Short	1-1469387-1
A2	Mid-Plane	Vertical Male, Keyed, Long	1-1469388-1

**Note:** Part Numbers are RoHS compliant.

AdvancedMC, AdvancedTCA, AdvancedTCA 300, MicroTCA and PICMG are trademarks of PICMG-PCI Industrial Computer Manufacturers Group Incorporated.

## Product Defined in MicroTCA Specification

### Vertical AdvancedMC Connector for MicroTCA Applications

#### FEATURES

- Press-fit connector per MicroTCA.0 Specification
- 170 lines
- Connector designed so that custom load patterns are easily created
- Single overmolded wafer design
- Fully validated electrical models available



#### Part Number 1469820-X

##### Product Specification

108-2254

##### Application Specification

114-13180

Part Number	Tail Plating	Alignment Post
1469820-1	Tin	No
1469820-2	Tin	Yes
1469820-3●	Tin-Lead	No
1469820-4●	Tin-Lead	Yes

Product Defined in MicroTCA Specification

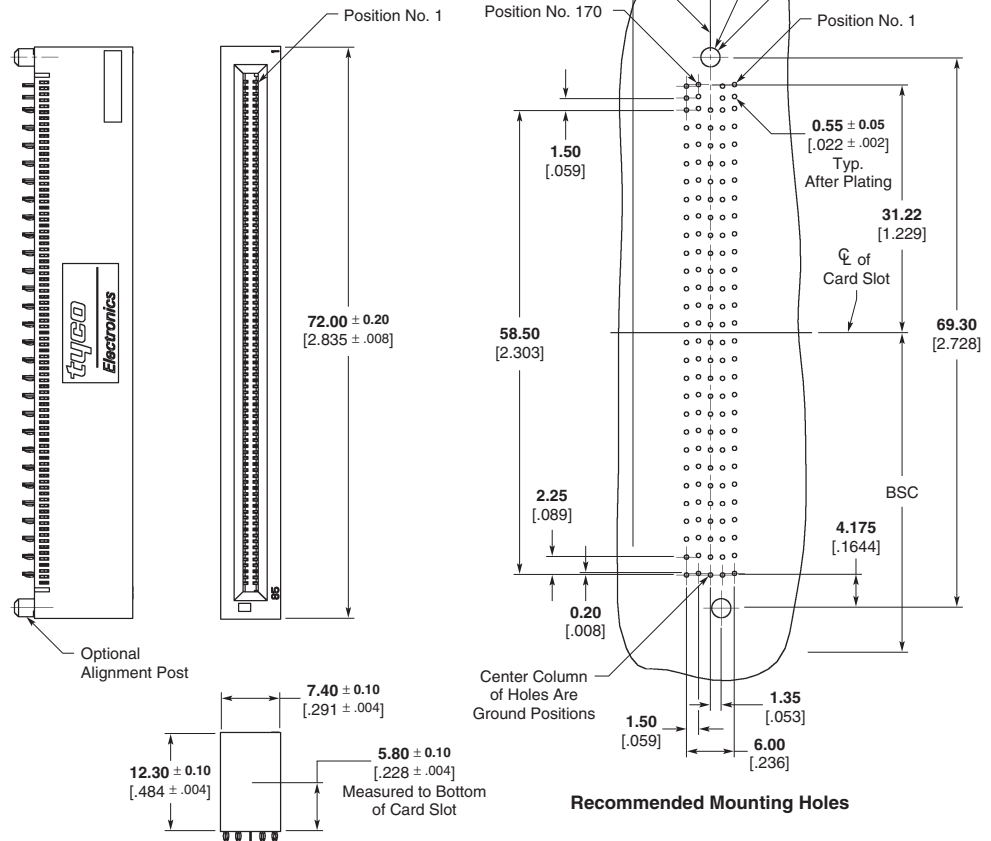

AdvancedMC, AdvancedTCA, AdvancedTCA 300, MicroTCA and PICMG are trademarks of PICMG-PCI Industrial Computer Manufacturers Group Incorporated.

**Note:** Part Numbers are RoHS compliant except: ● Indicates "5 of 6 compliant" (lead in solderable interface only).

**Product Defined in MicroTCA Specification** (Continued)

**MINIPAK HD Power Connectors**

The MINIPAK HD Connector is a 2-piece board-to-board connector designed to meet the PICMG MicroTCA specification. The connector consists of 24 power contacts and 72 high density signal contacts.

**Application**

Designed for a broad range of applications in Telecom Edge and customer premise equipment, CATV hardware, wireless base stations and other communication equipment manufactured to the MicroTCA (PICMG AdvancedMC 1.0) specification. Rugged contact design and post-plated 30 micro-inch gold plating provides long-term reliability in demanding environments.

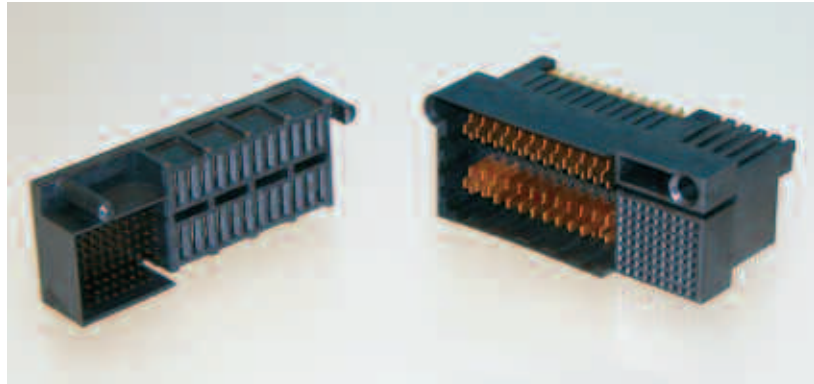

**Electrical Characteristics**

**Current Ratings** — tested in accordance with IEC 60512-5-2 Test 5a requirements:

**Signal Contacts** — .625 ampere each

**Power Contacts** —  
11.625 ampere each (PICMG MicroTCA R1.0 requirement)

14.5 ampere each (Tyco Electronics MINIPAK HD performance)

**Dielectric Withstanding Voltage** — 80 volts rms between differential pair conductors, general purpose conductors, and power conductors

**Environmental Characteristics**

**Maximum Continuous Operating Temperature** — 100°C

**Durability Rating** — 250 cycles

**Technical Documents**

**Tyco Electronics Product Specification** — 108-2253

**PICMG Specification** — PICMG MicroTCA Standard

**FEATURES:**

- High Current Density
- 24 power contacts capable of carrying 14.5 Amps per contact when fully energized
- Industry proven UPM power contacts
- Hot Plug contact design controls arc during hot mate/un-mate cycles
- 3 Mating Levels:  
1st — Power/Ground,  
2nd — Power/Signal,  
3rd — Short/Enable Signal
- Tin Plated (fully RoHS compliant) or tin-lead (5 of 6 RoHS compliant) pcb tails



AdvancedMC, AdvancedTCA, AdvancedTCA 300, MicroTCA and PICMG are trademarks of PICMG-PCI Industrial Computer Manufacturers Group Incorporated.



**Product Defined in MicroTCA Specification** (Continued)

**MINIPAK HD Power Connectors** (Continued)

**Vertical Receptacle**  
**Part Number 1469920-1** ●  
 (tin-lead pcb tails)

**Part Number 1469920-2**  
 (tin plated pcb tails)

The vertical connector consists of 72 2 mm pin and 24 UPM receptacle contacts. The contacts have compliant pin tails for press-fit applications.

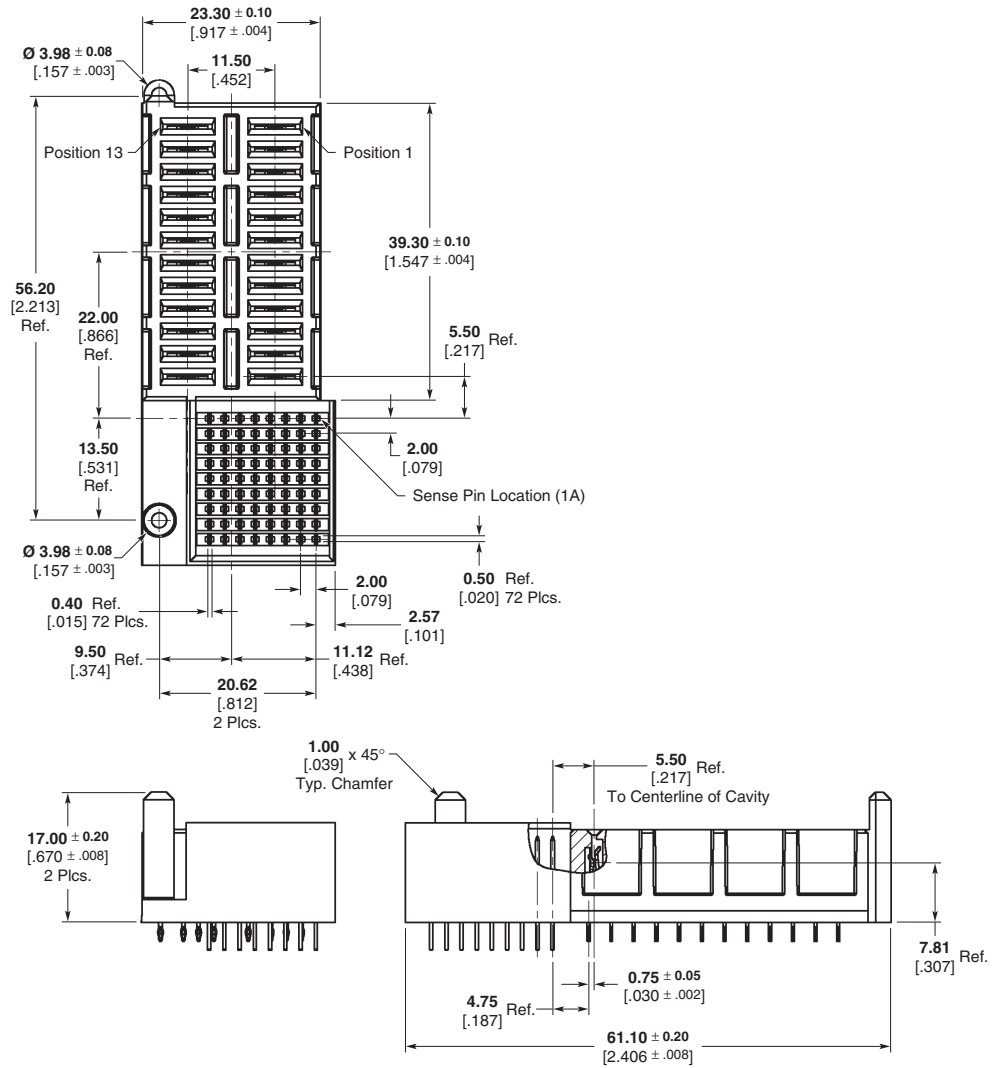

Product Defined in  
 MicroTCA Specification

AdvancedMC, AdvancedTCA, AdvancedTCA 300, MicroTCA and PICMG are trademarks of PICMG-PCI Industrial Computer Manufacturers Group Incorporated.

**Note:** Part Numbers are RoHS compliant except: ● Indicates "5 of 6 compliant" (lead in solderable interface only).

**Product Defined in MicroTCA Specification (Continued)**

**MINIPAK HD Power Connectors (Continued)**

**Right Angle Plug  
Part Number 1469921-1  
(solder tail)**

**Part Number 1469922-1  
(press-fit)**

**Part Number 1469922-2●  
(press-fit, tin-lead pcb tails)**

The right angle connector consists of 72 high density signal pins and 24 right angle UPM blades in a 2 x 12 configuration. There are 8 power blades that are longer for first mate/break last ground sequencing. The right angle connectors come in 2 piece tail variations, press-fit and solder.

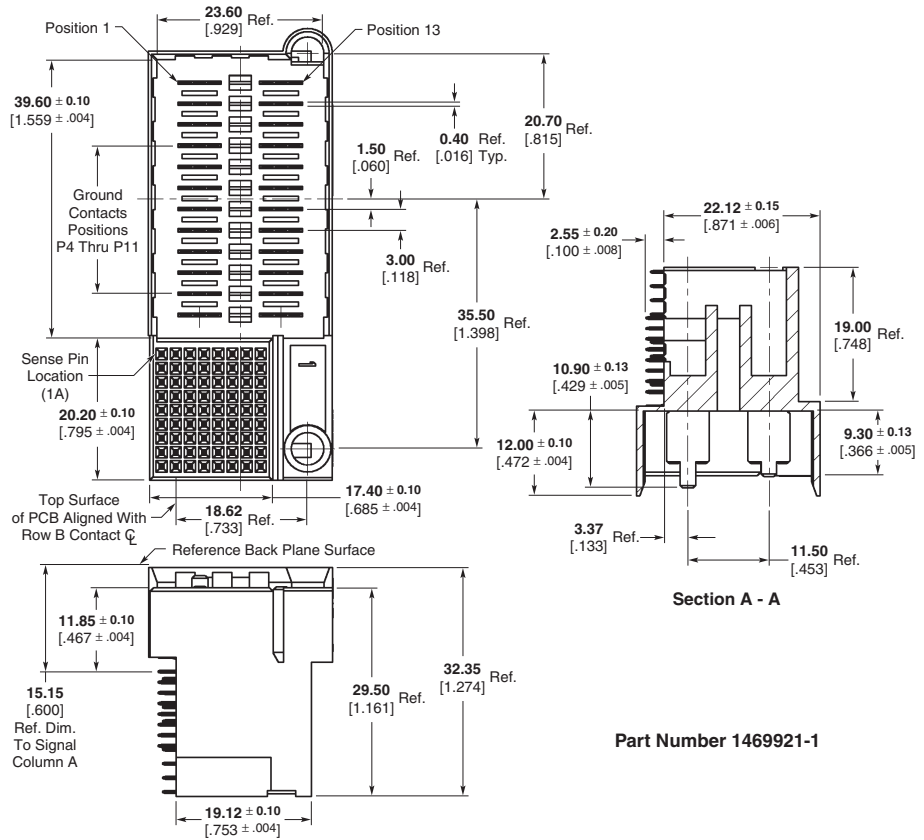

Part Number 1469921-1

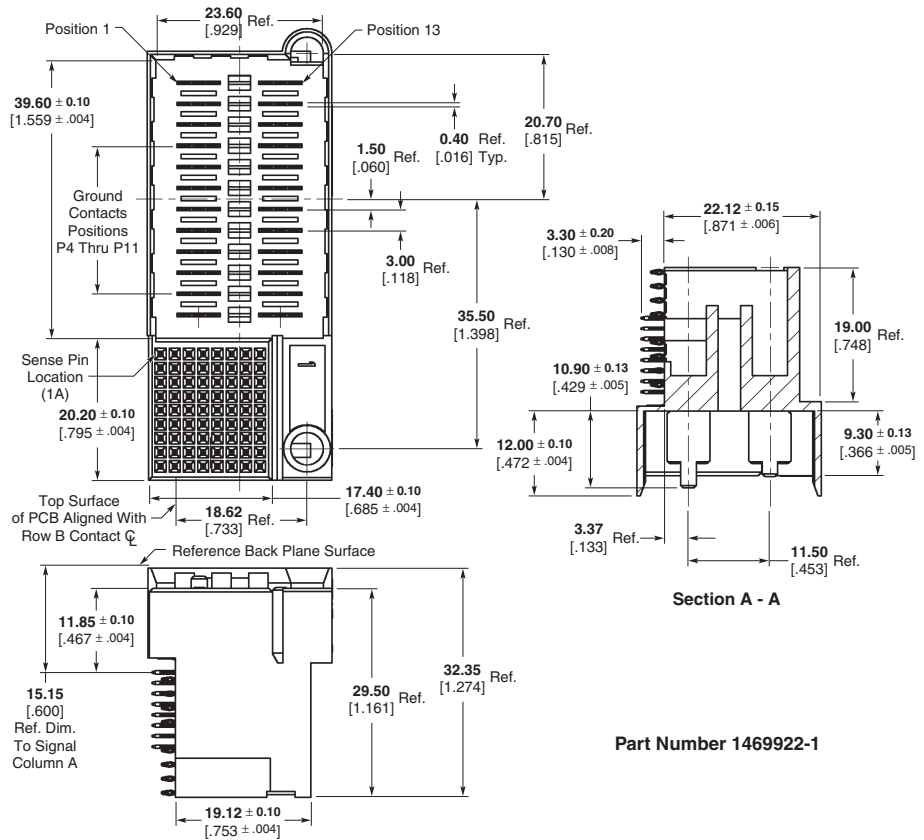

Part Number 1469922-1

**Note:** Part Numbers are RoHS compliant except: ● Indicates "5 of 6 compliant" (lead in solderable interface only).

AdvancedMC, AdvancedTCA, AdvancedTCA 300, MicroTCA and PICMG are trademarks of PICMG-PCI Industrial Computer Manufacturers Group Incorporated.

## Product Compliant to xTCA or AdvancedMC Specifications

### Stacked RJ45 Modular Jacks for AdvancedTCA, AdvancedMC Standards

Tyco Electronics has released new stacked RJ45 modular jacks designed to meet both AdvancedTCA and AdvancedMC standards. The offset has been designed to fit the faceplate and board layout in AdvancedTCA and full-size AdvancedMC modules, while providing the port density of the stacked configuration. These jacks are shielded and include panel ground springs for EMI containment. They are available in 2x1, 2x4, 2x6, and 2x8 configurations, with and without LEDs, and are designed for GigE performance.



[www.tycoelectronics.com/products/atca](http://www.tycoelectronics.com/products/atca)

Catalog 82066

#### FEATURES

- Offset designed to meet both AdvancedTCA and AdvancedMC standards
- Category 5 Performance
- Available in 2x1, 2x4, 2x6, and 2x8 configurations
- Press-fit termination to the board
- Available with various LED options

Part Number (3.27 mm Offset)	Configuration	LED #1 (Lower Port Left Side)	LED #2 (Upper Port Left Side)	LED #3 (Upper Port Right Side)	LED #4 (Lower Port Right Side)	Ground Clips	Shield Side Ground Pins
1888652-1	2x1	None	None	None	None	No	Yes
1888652-2	2x1	None	None	None	None	Yes	Yes
1888653-1	2x1	Green	Green	Green	Green	No	Yes
1888653-2	2x1	Green	Green	Green	Green	Yes	Yes
1888653-3	2x1	Yellow	Yellow	Green	Green	Yes	Yes
1888653-4	2x1	Green	Green	Yellow	Yellow	Yes	Yes
1888506-1	2x4	None	None	None	None	No	Yes
1888506-2	2x4	None	None	None	None	Yes	Yes
1888507-1	2x4	Green	Green	Green	Green	No	Yes
1888507-2	2x4	Green	Green	Green	Green	Yes	Yes
1888507-3	2x4	Green	Green	Yellow	Yellow	No	Yes
1888507-4	2x4	Green/Yellow	Green/Yellow	Green/Yellow	Green/Yellow	Yes	Yes
1888508-1	2x6	None	None	None	None	No	Yes
1888508-2	2x6	None	None	None	None	Yes	Yes
1888509-1	2x6	Green	Green	Green	Green	No	Yes
1888509-2	2x6	Green	Green	Green	Green	Yes	Yes
1888509-3	2x6	Green	Green	Yellow	Yellow	No	Yes
1888509-4	2x6	Green/Yellow	Green/Yellow	Green/Yellow	Green/Yellow	Yes	Yes
1888654-1	2x8	None	None	None	None	No	No
1888654-2	2x8	None	None	None	None	No	Yes
1888654-3	2x8	None	None	None	None	Yes	Yes
1888654-4	2x8	None	None	None	None	Yes	No
1888655-1	2x8	Green	Green	Green	Green	No	No
1888655-2	2x8	Green	Green	Green	Green	No	Yes
1888655-3	2x8	Green	Green	Green	Green	Yes	Yes
1888655-4	2x8	Green	Green	Green	Green	Yes	No
1888655-5	2x8	Green	Green	Yellow	Yellow	No	Yes

**Note:** Part Numbers are RoHS compliant.

AdvancedMC, AdvancedTCA, AdvancedTCA 300, MicroTCA and PICMG are trademarks of PICMG-PCI Industrial Computer Manufacturers Group Incorporated.

**Product Compliant to xTCA or AdvancedMC Specifications** (Continued)

**Low Profile RJ45 Modular Jacks**

To meet the requirements for I/O connectors on AdvancedTCA and AdvancedMC cards, Tyco Electronics has released new low profile RJ45 modular jacks. The offset from the board is designed such that it fits in an AdvancedMC half height faceplate. These jacks are shielded and include panel ground springs for EMI containment. They are available in single port and 1x4 configurations, with and without LEDs, and are designed for GigE performance.

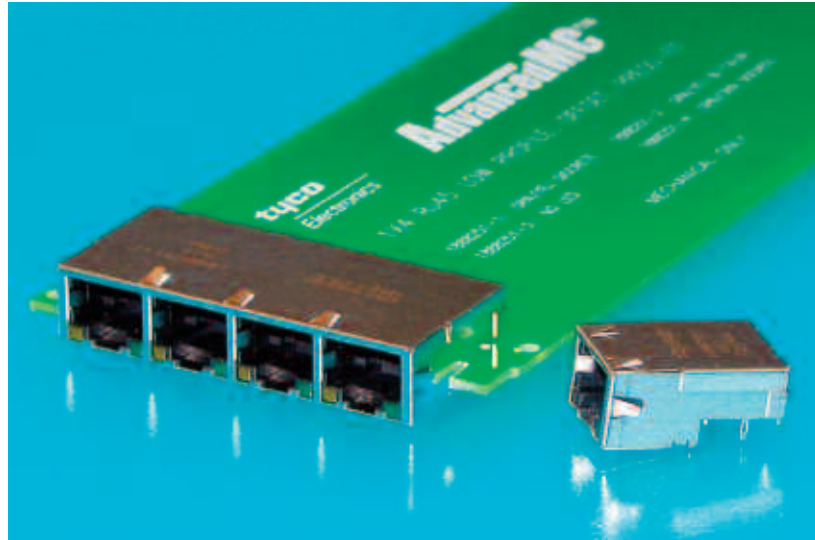

**FEATURES**

- Category 5e Performance
- Available in single port and 1x4 configurations
- Low profile meets half height requirements. 4.20 mm above PCB, 7.38 mm below PCB
- Press-fit termination to the board
- Available with various LED options

Part Number	Configuration	LED (Left)	LED (Right)
1888250-1	1x1	Green	Yellow
1888250-2	1x1	Green/Yellow	Green/Yellow
1888250-3	1x1	None	None
1888250-4	1x1	Green	Green
1888251-1	1x4	Green	Yellow
1888251-2	1x4	Green/Yellow	Green/Yellow
1888251-3	1x4	None	None
1888251-4	1x4	Green	Green

**Note:** Part Numbers are RoHS compliant.

AdvancedMC, AdvancedTCA, AdvancedTCA 300, MicroTCA and PICMG are trademarks of PICMG-PCI Industrial Computer Manufacturers Group Incorporated.



**Product Compliant to xTCA or AdvancedMC Specifications** (Continued)

**AdvancedTCA — Front & Rear I/O Connectors – SFP Modules**

The SFP (Small Form-Factor Pluggable) supports hot swap of various types of fiber optics and copper based transceivers into host equipment. This allows the customer to have a flexible change between different protocols. The different applications are Fiber Channel, Ethernet, and Infiniband. SFP board cages exist in multiple versions that fit AdvancedTCA systems.

The one port cages are available in a one piece design (press-fit or solder) and a two piece design (press-fit, solder or SMT). Ganged versions (available in 1x6; 1x4; 1x2) are available with or without light pipes. The ganged product has the option of integrated host connector. Tyco Electronics is currently developing stacked versions (2x4 as primary option) that fit AdvancedTCA requirements.

[www.tycoelectronics.com/product/atca](http://www.tycoelectronics.com/product/atca)  
[www.sfp.tycoelectronics.com](http://www.sfp.tycoelectronics.com)

**Catalog 1773408**  
**Flyer 1654720 / 1654095 / 1773078**

**FEATURES**

- Products according to MSA (Multi-Source Agreement)
- Uses 20 positions PT connector
- Hot Swappable
- Three stage sequencing
- Supports data-rates up to 5 Gbps
- Chassis ground for pass through EMI protection to 12.5 Gbps
- Accepts copper and fiber optic transceivers
- Direct attach copper cable assemblies available with or without active equalization.

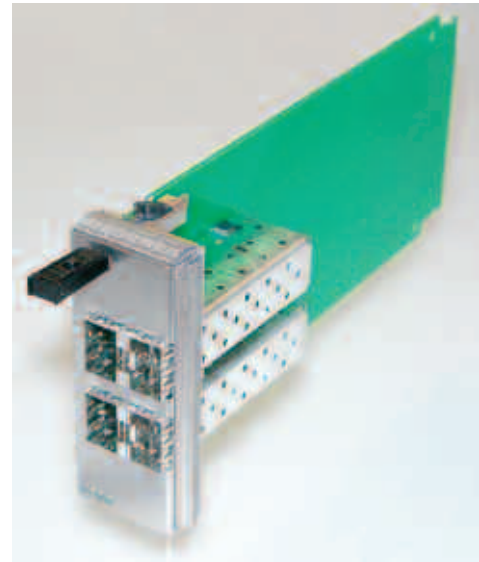

**SFP Modules**

Part Number	Port Configuration	Insertion Style	Connector Included	Height Profile
<b>Stacked</b>				
1658628-1	2x1	Press-fit	Yes	Low
1658629-1	2x4	Press-fit	Yes	Low
1658894-1	2x6	Press-fit	Yes	Low
<b>Ganged</b>				
1761014-1	1x2	Press-fit	No	—
1658744-1	1x4	Press-fit	No	—
1761015-1	1x6	Press-fit	No	—
<b>Single</b>				
6367035-1	1x1	Solder Tail	No	Standard
6367034-1	1x1	Solder Tail	No	Standard
1489669-1	1x1	Press-fit	No	Standard
1489779-1	1x1	Press-fit	No	Standard

**Note:** Part Numbers are RoHS compliant.

AdvancedMC, AdvancedTCA, AdvancedTCA 300, MicroTCA and PICMG are trademarks of PICMG-PCI Industrial Computer Manufacturers Group Incorporated. Infiniband is a trademark of Infiniband Trade Association.

Product Compliant to xTCA or AdvancedMC Specifications

**Product Compliant to xTCA or AdvancedMC Specifications** (Continued)

**AdvancedTCA — Front & Rear I/O Connectors — MRJ21 Receptacles**

Tyco Electronics' MRJ21 receptacle is a high density I/O interconnect. This high density connector supports AdvancedMC Mid-size and Full-size module face plates and AdvancedTCA face plates. It can also be used for Rear I/O via Rear Transition Modules (RTMs), as well as in AdvancedTCA Zone 3 applications.

The MRJ21 connector is fully shielded and provides density savings for current 10/100 or GbE RJ45/RJ21 applications. The low profile and narrow width design will allow more ports to be packed into less space.

Tyco Electronics offers a full end-user solution with cleaner cabling solutions over RJ45s, and patch panels for plug-and-play environment, including data centers and zone cabled or open office environments.

[www.tycoelectronics.com/products/atca](http://www.tycoelectronics.com/products/atca)

**FEATURES**

- 1.5 to 3 times the port density of stacked Mod Jacks (RJ45). 3 times the port density of RJ21
- Contact layout and footprint for differential pairs creates reduced cross-talk and built in compensation
- Connector is designed to meet or exceed Cat 5e cross-talk
- Fully shielded system to control EMI (Electro-magnetic Interference)
- Robust die cast cable covers provide 45 degrees left or right cable exit for ease of routing
- 1 mm pair spacing, 1.5 mm pair to pair spacing
- Patch panels and cable management solutions available



**MRJ21 PCB Receptacles (48-position)**

Part Number	Panel Grounds	PCB Termination
1761482-1	No	Solder
1761482-2	Yes	Solder
1761482-4	No	Press-Fit

**Receptacle Screwlocks**

Part Number	Panel Thickness
1339381-1	< 1mm
1339381-2	> 1mm to < 2mm

Screwlocks sold separately

**Note:** Part Numbers are RoHS compliant.

**AdvancedTCA — Thermal Products & Services**

Thermal Interface Products are mandatory for reducing the waste heat and cooling the system in the most efficient way. Waste heat reduces the silicon chip reliability and performance. In addition to the products Tyco Electronics is offering such as Heat Sinks, Heat Pipes and CHIP COOLERS, in all shapes and sizes, Tyco Electronics offers state of the art Thermal Management Services. Thermal Management is the design practice of moving waste heat to locations that do not affect the equipment or overall device performance. Each Thermal Product can be fully customized to fulfill the specific requested system cooling requirements.

[www.tycoelectronics.com/products/atca](http://www.tycoelectronics.com/products/atca)  
[www.thermal.tycoelectronics.com](http://www.thermal.tycoelectronics.com)

**Catalog 1309431  
Flyer 1308225**

**FEATURES**

- Tyco Electronics thermal solutions provide optimum cooling for active components like BGA (Ball Grid Array), MCM modules, optical modules and power devices
- Compatible to most AdvancedTCA connector form factors, low profile solutions
- Off the shelf as well as customized products
- Heat pipe technology in combination with passive heat sinks
- Advanced thermal conductive polymer for weight and cost reduction
- Full CFD (Computational Fluid Dynamics) simulation and analysis, optimum Thermal design numerical and analytical approaches

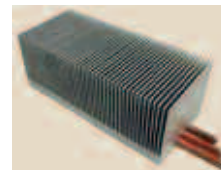

AdvancedMC, AdvancedTCA, AdvancedTCA 300, MicroTCA and PICMG are trademarks of PICMG-PCI Industrial Computer Manufacturers Group Incorporated.

**Product Compliant to xTCA or AdvancedMC Specifications** (Continued)

**Low Profile DDR2 Connector for AdvancedTCA Standards**

The new Tyco Electronics Low Profile DDR2 connector is designed for the main memory requirements on the AdvancedTCA carrier boards. Developed for use with a new VLP (Very Low Profile) module from Micron Technology, this connector meets the AdvancedTCA height limitations on the carrier board.

In addition, this connector offers a new ejector design that allows airflow to reach the memory module DRAMs for effective cooling.

**FEATURES**

- Accepts new Micron Technology VLP (Very Low Profile) DDR2 memory module designed specifically for the AdvancedTCA carrier board
- Special designed ejectors that allow airflow to reach memory module DRAMs for efficient cooling
- Low module seating plane allows for increased module space for module components in a VLP form factor
- Utilizes proven Tyco Electronics DDR2 contact design for reliable interface to the memory module
- Available in 3 solder tail lengths and contact interface plating options

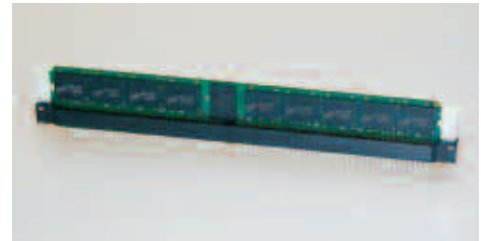
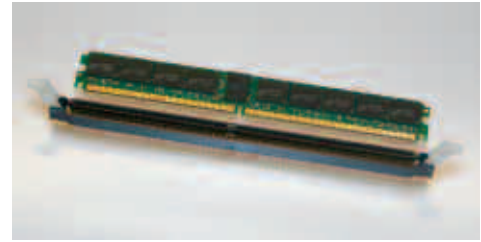

**Part Number 1888669-1**

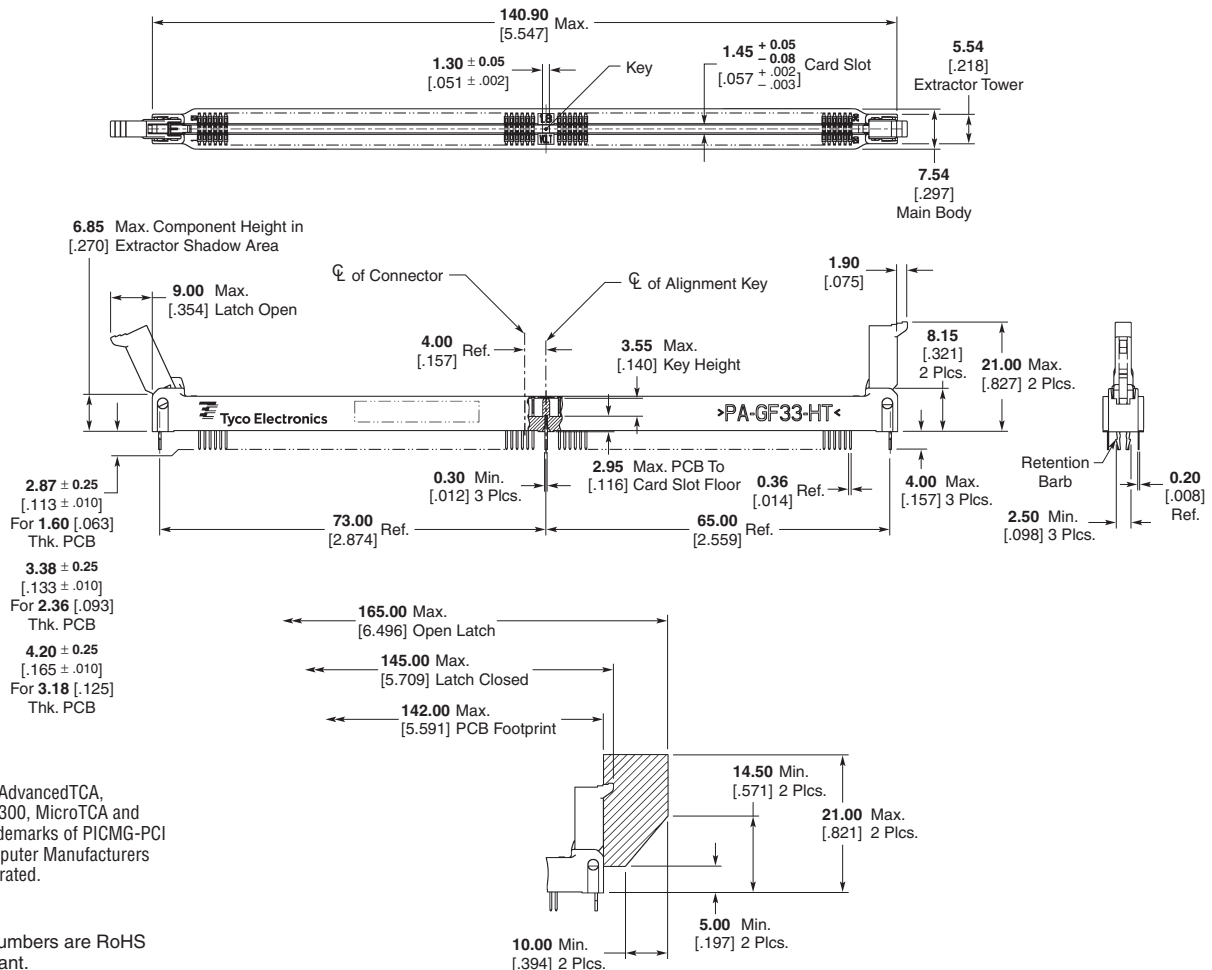

AdvancedMC, AdvancedTCA, AdvancedTCA 300, MicroTCA and PICMG are trademarks of PICMG-PCI Industrial Computer Manufacturers Group Incorporated.

**Note:** Part Numbers are RoHS compliant.

Product Compliant to xTCA or AdvancedMC Specifications

**Product Compliant to xTCA or AdvancedMC Specifications** (Continued)

**Small Outline Dual In-Line Memory Module (SO DIMM) for AdvancedMC Applications**

The Small Outline Dual In-Line Memory Module (SO DIMM) is the latest in the Tyco Electronics DIMM product line and was specifically designed to meet the AdvancedMC Specification. The SO DIMM has 200 positions in a dual row design, and features gold flash solder tail contact plating. Available in two heights, the SO DIMM will fit any AdvancedMC Application.

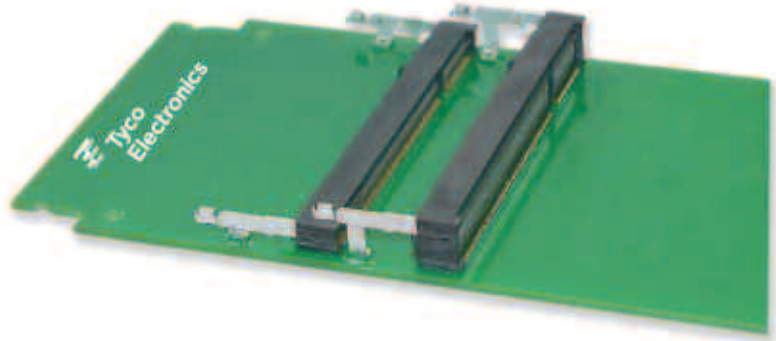

**FEATURES**

- 200 positions
- Gold Flash Solder Tail Contact Plating

Part Number	Stack Height	Keying Feature
1981281-4	5.20 .203	Reverse
1981276-4	5.20 .203	Standard
1981287-4	9.20 .360	Reverse
1981284-4	9.20 .360	Standard

**Part Number 1981281-4**

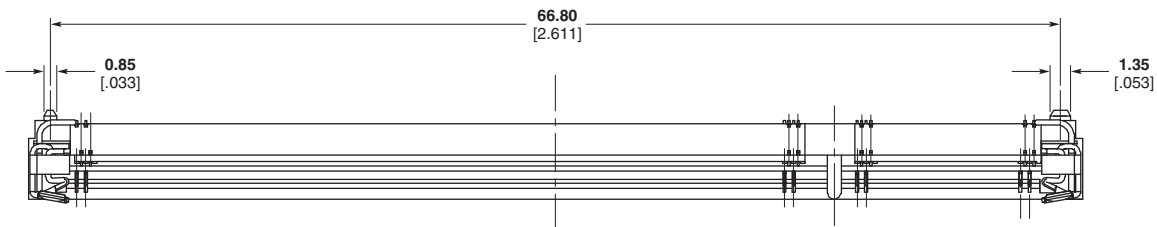

AdvancedMC, AdvancedTCA, AdvancedTCA 300, MicroTCA and PICMG are trademarks of PICMG-PCI Industrial Computer Manufacturers Group Incorporated.

**Note:** Part Numbers are RoHS compliant.



## Product Compliant to xTCA or AdvancedMC Specifications (Continued)

### 1.0 mm Free Height (FH) (IEEE 1386) Connectors

As a standard for adding local PCI or Sbus performance to Futurebus+ and VMEbus applications, IEEE 1386 offers new levels of performance and packaging convenience through the mezzanine architecture.

Tyco Electronics makes it easier and more productive to add an IEEE 1386 mezzanine connector to your system. The surface-mount parallel stacking connector features contacts on a 1.0 [.039] pitch and is available in eight stacking heights from 8 [.315] to 15 [.591]. Sizes include the IEEE 1386 standard 64-position version and an optional 84-position version.

Not only is the connector compatible with EIA-700 AAAB — the connector standard for IEEE 1386 mezzanine connectors — it offers several enhancements that make it easier to use and more reliable. Increased plastic clearance between mating connectors makes it easier to align multiple connectors for mating, thus eliminating stress to the solder joints during engagement. Improved locating posts allow fast, highly accurate hand placement of connectors. The connectors are available with vacuum covers for automated placement.

#### Performance Characteristics

##### Current Rating —

1.0 ampere per contact

##### Contact Resistance —

30 milliohms max. (initial)

##### Durability —

tested to 100 mating cycles min.

#### Product Specification

108-2246

### 1.0 mm FH (IEEE 1386) Receptacles and Plugs without Locating Posts, 1.0 [.039] Pitch

#### 8 [.315] thru 15 [.591] Stacking Heights Material and Finish

**Housing** — Liquid crystal polymer, black

**Contacts** — Phosphor bronze; duplex plated 0.00076 [.000030] or .00127 [.00050] min. gold on contact area, 0.00381 [.000150] min. tin on solder area, with entire contact underplated 0.00127 [.000050] min. nickel

**Vacuum Cover** — Aluminum Alloy

#### Technical Documents

EIA-700 AAAB Specification

Application Specification

114-25045

AdvancedMC, AdvancedTCA, AdvancedTCA 300, MicroTCA and PICMG are trademarks of PICMG-PCI Industrial Computer Manufacturers Group Incorporated.

**Note:** Part Numbers are RoHS compliant.

#### FEATURES:

- For board stacking applications
- High density packaging on 1.0 [.039] centerline spacing
- Available in standard 64-position and optional 84-position sizes
- "Tape-and-reel" packaged per EIA standards
- Board stacking heights available from 8 [.315] to 15 [.591]
- Increased plastic clearance eliminates stress to solder joints during mating
- Improved locating posts provide accurate hand or robotic placement
- Meets EIA-700 AAAB specifications for IEEE 1386 applications



No. of Positions	Height	Receptacle Part Number	
		30µ" Au Plating w/ pickup cap	50µ" Au Plating w/ pickup cap
64	5.37 .211	5120528-1	1-5120528-1
	7.37 .290	5120529-1	1-5120529-1
	8.37 .330	5120530-1	1-5120530-1
	10.37 .408	5120531-1	1-5120531-1
84	5.37 .211	5120528-2	1-5120528-2
	7.37 .290	5120529-2	1-5120529-2
	8.37 .330	5120530-2	1-5120530-2
	10.37 .408	5120531-2	1-5120531-2

**Notes:** 1. Shorter solder lands may be used per EIA-700 AAAB. However, the 2.4 [.094] length assures optimum solder fillet regardless of connector manufacturer.

No. of Positions	Height	Plug Part Number	
		30µ" Au Plating w/ pickup cap	50µ" Au Plating w/ pickup cap
64	6.35 .250	5120532-1	1-5120532-1
	7.35 .289	5120533-1	1-5120533-1
	8.35 .329	5120534-1	1-5120534-1
84	6.35 .250	5120532-2	1-5120532-2
	7.35 .289	5120533-2	1-5120533-2
	8.35 .329	5120534-2	1-5120534-2

**Notes:** 1. Shorter solder lands may be used per EIA-700 AAAB. However, the 2.7 [.106] length assures optimum solder fillet regardless of connector manufacturer.

**Product Compliant to xTCA or AdvancedMC Specifications** (Continued)

**AdvancedTCA — Power Distribution & Management Modules**

Tyco Electronics Power Systems introduces the industry's first power input management solution for AdvancedTCA boards. The AdvancedTCA power input module (PIM) is designed in collaboration with industry leading AdvancedTCA board manufacturers and provides innovative features and compact design. PIM modules incorporate all the features required by AdvancedTCA specifications (PICMG 3.0) and enable designers to save valuable board real estate and reduce overall board cost and time to market compared to discrete solutions.

**A Complete Power Architecture**

PIM series along with Tyco Electronics' isolated DC/DC and bus converters and point of load modules, provide a complete and low-cost power architectural solution while complying with AdvancedTCA board power requirements.

[www.tycoelectronics.com/products/atca](http://www.tycoelectronics.com/products/atca)  
[www.power.tycoelectronics.com](http://www.power.tycoelectronics.com)

**Flyer PIM05-001**

**FEATURES**

- 200/300 W of power (per PICMG 3.0)
- Inrush control protection
- Integrated EMI filter designed to meet CISPR Class B Limits
- Directive 2002/95/EC RoHS compliant
- 8 W of Isolated auxiliary power supply for IPMI (3.3 V or 5 V)
- O-Ring FETs for -48 V A&B feeds
- A/B feed loss alarm
- Hot-swap control
- 72 V charging voltage for holdup/bulk capacitors
- Through-hole and surface mount (SMT) versions
- Input under-voltage and over-voltage protections
- Over current and thermal protections
- UL/CSA/CE/VDE approved



	<b>PIM</b>	<b>Discrete</b>
PICMG 3.0 compliant	Yes	Board level
Fully tested & burned-in	Yes	Board level
Fully qualified	Yes	Board level
Parts count	1	> 100
Design-in time	Lower	Higher
Assembly cost	Lower	Higher
Yield/Repair cost	Lower	Higher
Time to market	Lower	Higher
Standard off-shelf part	Yes	No

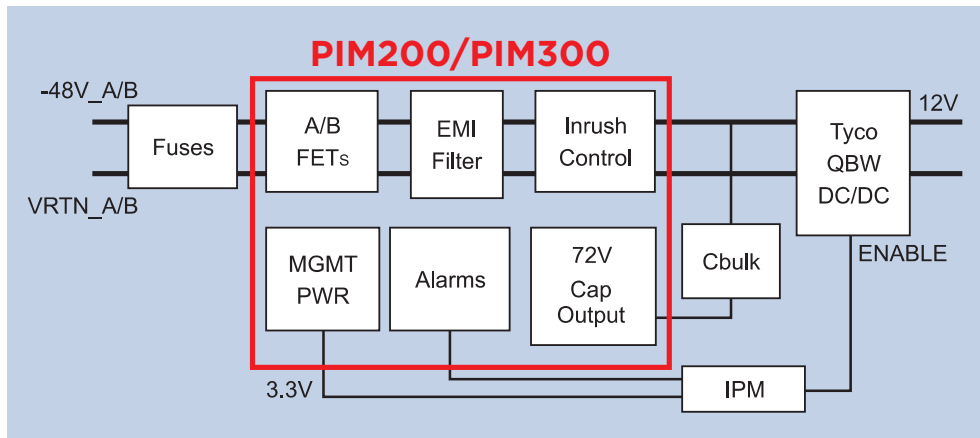

Device Code	Input Voltage	Output Power	V <sub>mg/mt</sub> Output	Connector Type	Comcode
PIM200FZ	-48 V (-38 to -75 V DC)	200 W	-3.3 V DC	Thru Hole	CC109101813
PIM200AZ	-48 V (-38 to -75 V DC)	200 W	-5.0 V DC	Thru Hole	CC109106762
PIM300FZ	-48 V (-38 to -75 V DC)	300 W	-3.3 V DC	Thru Hole	CC109113858
PIM300AZ	-48 V (-38 to -75 V DC)	300 W	-5.0 V DC	Thru Hole	CC109122322

AdvancedMC, AdvancedTCA, AdvancedTCA 300, MicroTCA and PICMG are trademarks of PICMG-PCI Industrial Computer Manufacturers Group Incorporated.

**Product Compliant to xTCA or AdvancedMC Specifications** (Continued)

**AdvancedTCA — Power Distribution & Management Modules** (Continued)

**A Complete Power Architecture**

PIM series along with Tyco Electronics' isolated DC/DC and bus converters and point of load modules, provides a complete and low-cost power architectural solution while complying with AdvancedTCA power board requirements.

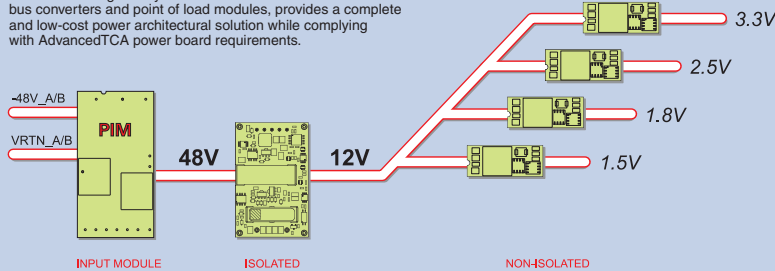

**Isolated Bus Converters**

Full Featured DC-DC Converter Series	Output Power (W)	Output Current (A)	Input Voltage (V)	Output Voltage (V)	Efficiency (%)	Current Share	Form Factor	Connection Type	Base Plate
EQW006A0B	72 W	6 A	48 V (36 – 75)	12 V (11.6 – 12.4)	92 %	No	Eight-Brick	TH/SMT	No
EQW010A0B	120 W	10 A	48 V (36 – 75)	12 V (11.4 – 12.6)	93 %	No	Eight-Brick	TH	Yes
QBW018A0B	200 W	18 A	48 V (36 – 75)	12 V (11.4 – 12.6)	94 %	Yes	Qtr-Brick	TH	Yes
QBW025A0B	300 W	25 A	48 V (36 – 75)	12 V (11.4 – 12.6)	94 %	Yes	Qtr-Brick	TH	Yes
JRB017A0B	200 W	17 A	48 V (36 – 75)	12 V (11.7 – 12.3)	92 %	Yes	Half-Brick	TH	Yes

**Non-Isolated DC-DC Converters**

Austin Lynx Series	Output Current (A)	Input Voltage Range (V)	Output Voltage Range (V)	Efficiency (%)	Output Programmable	Remote On/Off	Remote Sense	EZ-Sequence	Connector Type
Austin MiniLynx	3 A	8.3 – 14 V	0.75 – 5.0 V	91 %	Yes	Yes	No	No	SIP/SMT
Austin MicroLynx	5 A	10 – 14 V	0.75 – 5.0 V	89 %	Yes	Yes	No	No	SIP/SMT
Austin Lynx	10 A	10 – 14 V	0.75 – 5.0 V	93 %	Yes	Yes	Yes	No	SIP/SMT
Austin SuperLynx	16 A	10 – 14 V	0.75 – 5.0 V	92 %	Yes	Yes	Yes	No	SIP/SMT

Austin Lynx II Series	Output Current (A)	Input Voltage Range (V)	Output Voltage Range (V)	Efficiency (%)	Output Programmable	Remote On/Off	Remote Sense	EZ-Sequence	Connector Type
Austin MicroLynx II	6 A	8.3 – 14 V	0.75 – 5.0 V	89 %	Yes	Yes	No	Yes	SIP/SMT
Austin Lynx II	10 A	8.3 – 14 V	0.75 – 5.0 V	93 %	Yes	Yes	Yes	Yes	SIP/SMT
Austin SuperLynx II	16 A	8.3 – 14 V	0.75 – 5.0 V	92 %	Yes	Yes	Yes	Yes	SIP/SMT
Austin MegaLynx II	25 A	6.0 – 14 V	0.80 – 3.3 V	92.5 %	Yes	Yes	Yes	Yes	SIP/SMT

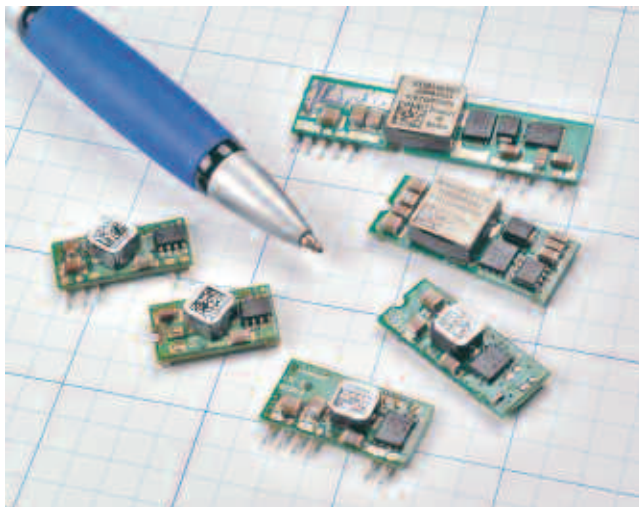

AdvancedMC, AdvancedTCA, AdvancedTCA 300, MicroTCA and PICMG are trademarks of PICMG-PCI Industrial Computer Manufacturers Group Incorporated.

Product Compliant to xTCA or AdvancedMC Specifications

## Part Number Index

**Note:** This index lists all cataloged parts by base no. only. Complete part nos. (with prefixes and/or suffixes) are shown on the page(s) indicated.

Part No.	Page	Part No.	Page	Part No.	Page
120943	11	1761014	22	1934226	12
120954	11	1761015	22	1934229	12
120955	11	1761482	23	1981276	25
120956	11	1766500	5, 6	1981281	25
120957	11	1766501	5, 6	1981284	25
120958	11	1766502	6	1981287	25
1339381	23	1766503	6	5120528	26
1367703	13	1888250	21	5120529	26
1469269	15	1888251	21	5120530	26
1469372	15	1888506	20	5120531	26
1469373	15	1888507	20	5120532	26
1469374	15	1888508	20	5120533	26
1469387	15	1888509	20	5120534	26
1469388	15	1888652	20	5223961	11
1469735	12	1888653	20	5223963	11
1469737	12	1888654	20	6367034	22
1469793	12	1888655	20	6367035	22
1469795	12	1888669	24	6469001	7, 8, 10
1469820	16	1888765	14	6469002	7, 9
1469920	18	1888766	14	6469046	9
1469921	19	1934018	12	6469048	10
1469922	19	1934021	12	6469061	8
1469974	12	1934026	12	6469062	9
1469977	12	1934029	12	6469074	9
1489669	22	1934034	12	6469099	9
1489779	22	1934037	12	6469286	8
1658628	22	1934218	12	6469287	9
1658629	22	1934221	12	6469294	8
1658744	22	1934222	12	6469296	9
1658894	22	1934225	12	6469375	10

## Tooling Part Number Index

Part No.	Page	Part No.	Page	Part No.	Page
91347-1	8	91349-4	9	1583224-4	8
91347-2	8	91378-1	10	1583237-1	9
91347-3	8	91378-3	10	1583248-1	8
91347-4	8	1583220-1	9	1583255-1	9
91349-1	9	1583224-1	8	1804174-1	10
91349-2	9	1583224-2	8	1804177-1	10
91349-3	9	1583224-3	8		



---

## Tyco Electronics “At Your Service”

---

### Need more information?

Call Technical Support at the numbers listed on the next page.

Technical Support is staffed with specialists well versed in all Tyco Electronics products. They can provide you with:

- Technical Support
- Catalogs
- Technical Documents
- Product Samples
- Tyco Electronics  
Authorized Distributor  
Locations

### Website

---

**At [www.tycoelectronics.com](http://www.tycoelectronics.com)  
you'll find many useful applications and plenty of product information**

- **Product News —**  
The latest information on new developments from various Tyco Electronics brands.
- **Industries —**  
Use our industry pages to quickly find the right product for your application.
- **Products —**  
Discover information on our vast array of products ranging from Amplifiers to Wire & Cable.
- **Customer Service and Support —**  
Find contact numbers for Customer Service and Product Information Help Desks plus FAQs and online technical assistance.

---

## Product Websites

---

[www.tycoelectronics.com/products/atca](http://www.tycoelectronics.com/products/atca)  
[www.tycoelectronics.com](http://www.tycoelectronics.com)  
[www.elastomerictech.com](http://www.elastomerictech.com)  
[www.power.tycoelectronics.com](http://www.power.tycoelectronics.com)  
[www.antenna.tycoelectronics.com](http://www.antenna.tycoelectronics.com)  
[www.hmzd.tycoelectronics.com](http://www.hmzd.tycoelectronics.com)  
[www.mpi.tycoelectronics.com](http://www.mpi.tycoelectronics.com)  
[www.thermal.tycoelectronics.com](http://www.thermal.tycoelectronics.com)  
[www.multigirt.tycoelectronics.com](http://www.multigirt.tycoelectronics.com)  
[www.elconproducts.com](http://www.elconproducts.com)  
[www.tycoelectronics.com/fiberoptics](http://www.tycoelectronics.com/fiberoptics)

AdvancedMC, AdvancedTCA,  
AdvancedTCA 300, MicroTCA and  
PICMG are trademarks of PICMG-PCI  
Industrial Computer Manufacturers  
Group Incorporated.

**Americas**

**Argentina** – Buenos Aires  
Phone: +54-11-4733-2200  
Fax: +54-11-4733-2211

**Brasil** – São Paulo  
Phone: +55-11-3611-1311  
Fax: +55-11-3611-0397

**Canada** – Toronto  
Phone: +905-475-6222  
Fax: +905-474-5520

**Product Information Center:  
(Technical Support)**  
Phone: +905-470-4425  
Fax: +905-474-5525

**Colombia** – Bogota  
Phone: +57-1-231-9398  
Fax: +57-1-660-0206

**Mexico** – Mexico City  
Phone: +52-55-1106-0800  
+01-800-733-8926  
Fax: +52-55-1106-0901

**United States** – Harrisburg, PA  
Phone: +717-564-0100  
Fax: +717-986-7575  
**Product Information Center:  
(Technical Support)**  
Phone: +800-522-6752  
Fax: +717-986-7575

**For Latin/South American  
Countries not shown**  
Phone: +54-11-4733-2015  
Fax: +54-11-4733-2083

**Asia/Pacific**

**Australia** – Sydney  
Phone: +61-2-9554-2600  
Fax: +61-2-9502-2556  
**Product Information Center:  
(Technical Support)**  
Phone: +61-2-9840-8200  
Fax: +61-2-9634-6188

**India** – Bangalore  
Phone: +91-80-285-40800  
Fax: +91-80-285-40820

**Indonesia** – Jakarta  
Phone: +65-6482-0311  
Fax: +65-6482-1012

**Japan** – Toyko  
Phone: +81-44-844-8111  
Fax: +81-44-812-3207  
**Product Information Center:  
(Technical Support)**  
Phone: +81-44-844-8013  
Fax: +81-44-812-3200

**Korea** – Seoul  
Phone: +82-2-3415-4500  
Fax: +82-2-3486-3810

**Malaysia** – Kuala Lumpur  
Phone: +60-3-78053055  
Fax: +60-3-78053066

**New Zealand** – Auckland  
Phone: +64-9-634-4580  
Fax: +64-9-634-4586

**Philippines** – Makati City  
Phone: +632-848-0171  
Fax: +632-867-8661

**People's Republic of China**  
Hong Kong  
Phone: +852-2735-1628  
Fax: +852-2735-0243

Shanghai  
Phone: +86-21-2407-1588  
Fax: +86-21-2407-1599

Taiwan – Taipei  
Phone: +886-2-8768-2788  
Fax: +886-2-8768-2268

**Singapore** – Singapore  
Phone: +65-6482-0311  
Fax: +65-6482-1012

**Thailand** – Bangkok  
Phone: +66-2-955-0500  
Fax: +66-2-955-0505

**Vietnam and Indochina** –  
Ho Chi Minh City  
Phone: +84-8 930-5546  
Fax: +84-8 930-3443

**Europe/Middle East/Africa**

**Austria** – Vienna  
Phone: +43-1 90 5 60-0  
Fax: +43-1 90 5 60-1333

**Belgium** – Kessel-Lo  
Phone: +32-16-35-23-00  
Fax: +32-16-35-23-52

**Bulgaria** – Sofia  
Phone: +359-2-971-2152  
Fax: +359-2-971-2153

**Czech Republic** – Kurim  
Phone: +420-5-41-162-111  
Fax: +420-5-41-162-223

**Denmark** – Glostrup  
Phone: +45-43-480-452  
Fax: +45-43-441-414

**Egypt** – Cairo  
Phone: +20-2-29 04 281  
Fax: +20-2-41 92 334

**Estonia** – Tartu  
Phone: +372-5138-274  
Fax: +372-7400-779

**Finland** – Helsinki  
Phone: +358-95-12-34-20  
Fax: +358-95-12-34-250

**France** – Cergy-Pontoise  
Phone: +33-1-3420-8888  
Fax: +33-1-3420-8600

**Product Information Center:  
(Technical Support)**  
Phone: +33-1-3420-8943  
Fax: +33-1-3420-8623

**Germany** – Bensheim  
Phone: +49-6251-133-0  
Fax: +49-6251-133-1600

**Product Information Center:  
(Technical Support)**  
Phone: +49-6251-133-1999  
Fax: +49-6251-133-1988

**Germany** – Langen  
Phone: +49-6103-709-0  
Fax: +49-6103-709-1223

**Germany** – Speyer  
Phone: +49-6232-30-0  
Fax: +49-6232-30-2243

**Germany - HTS Division** – Neunkirchen  
Phone: +49-2247-305-0  
Fax: +49-2247-305-122

**Greece** – Athens  
Phone: +30-210-9370-396/397  
Fax: +30-210-9370-655

**Hungary** – Budapest  
Phone: +36-1-289-1000  
Fax: +36-1-289-1010

**Ireland** – Dublin  
Phone: +353-1-820-3000  
Fax: +353-1-820-9790

**Israel** – Yokneam  
Phone: +972-4-959-0508  
Fax: +972-4-959-0506

**Italy** – Collegno (Torino)  
Phone: +39-011-4012-111  
Fax: +39-011-4031116

**Lithuania** – Vilnius  
Phone: +370-5-2131-402  
Fax: +370-5-2131-403

**Netherlands** – 's-Hertogenbosch  
Phone: +31-73-624-62-46  
Fax: +31-73-621-23-65

**Product Information Center:  
(Technical Support)**  
Phone: +31-73-6246-999  
Fax: +31-73-6246-998

**Norway** – Nesbru  
Phone: +47-66-77-8886  
Fax: +47-66-77-8855

**Poland** – Warsaw  
Phone: +48-22-45-76-700  
Fax: +48-22-45-76-720

**Romania** – Bucharest  
Phone: +40-21-311-3479/3596  
Fax: +40-21-312-0574

**Russia** – Moscow  
Phone: +7-495-926-5506/07/08/09  
Fax: +7-495-926-5505

**Russia** – St. Petersburg  
Phone: +7-812-718-8192  
Fax: +7-812-718-8193

**Slovenia** – Ljubljana  
Phone: +386-1561-3270  
Fax: +386-1561-3240

**South Africa** – Port Elizabeth  
Phone: +2741-503-4500  
Fax: +2741-581-0440

**Spain** – Barcelona  
Phone: +34-93-291-0330  
Fax: +34-93-201-7879

**Product Information Center:  
(Technical Support)**  
Phone: +34-93-291-0330  
Fax: +34-93-200-3779

**Sweden** – Upplands Väsby  
Phone: +46-8-50-72-50-00  
Fax: +46-8-50-72-50-01

**Switzerland** – Steinach  
Phone: +41-71-447-0447  
Fax: +41-71-447-0444

**Turkey** – Istanbul  
Phone: +90-212-281-8181/2/3  
Fax: +90-212-281-8184

**Ukraine** – Kiev  
Phone: +380-044-206-2265  
Fax: +380-044-206-2264

**United Kingdom** – Swindon  
Phone: +44-8706-080-208  
Fax: +44-1793-572-516

**Product Information Center:  
(Technical Support)**  
Freephone GB: 0800-267-666  
Phone: +44-8706-080-208  
Fax: +44-208-420-8081

**For Middle East/African Countries  
Not Shown**  
Phone: +33-1-3420-8866  
Fax: +33-1-3420-8300

**Tyco Electronics Corporation**  
Harrisburg, PA

[tycoelectronics.com](http://tycoelectronics.com)

3-1773445-8-2.5M-LUG-FP-6-07

