

4

3

2

1

THIS DRAWING IS UNPUBLISHED. RELEASED FOR PUBLICATION MAY, 1995.
 © COPYRIGHT 1995 BY TYCO ELECTRONICS CORPORATION. ALL RIGHTS RESERVED.

AS SHOWN: TYPE-1

LOC	DIST	REVISIONS			
P	LTR	DESCRIPTION	DATE	DWN	APVD
J		REVISD ECR-07-031084	01FEB08	T.T	T.F

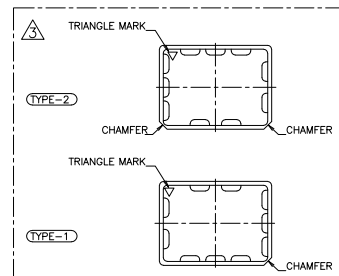
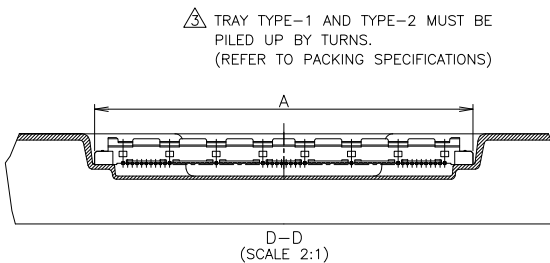
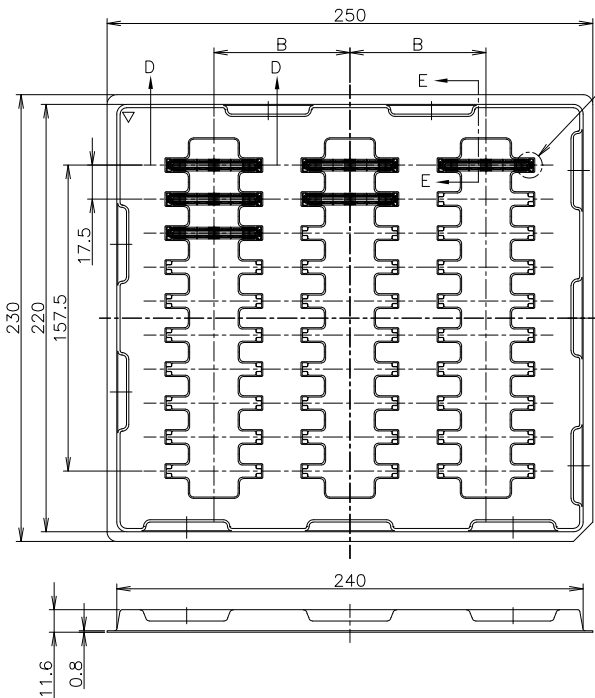

△ TRAY TYPE-1 AND TYPE-2 MUST BE
 PILED UP BY TURNS.
 (REFER TO PACKING SPECIFICATIONS)

SEALANT	STATUS	TOOLING STATUS	ROW	QTY	B	A	POS.	TRAY P/N	PART NO.
	OBSOLETE	NOT AVAILABLE	3	30	70	54.7	160	912063-9	6-316135-1
						48.7	140	912063-8	6- - -0
						42.7	120	4-912065-9	5- - -9
						36.7	100	8-912066-2	5- - -8
			3	30	70	33.7	90	9-912066-6	5- - -7
			5	50	43	30.7	80	912067-3	5- - -6
						27.7	70	912063-1	5- - -5
						24.7	60	9-912066-5	5- - -4
						21.7	50	9-912062-9	5- - -3
						18.7	40	9-912066-4	5- - -2
	OBSOLETE	NOT AVAILABLE	5	50	43	15.7	30	9-912066-3	5-316135-1
	ACTIVE	AVAILABLE	3	30	70	54.7	160	912063-9	1-316135-1
	ACTIVE	AVAILABLE				48.7	140	912063-8	1- - -0
	OBSOLETE	NOT AVAILABLE				42.7	120	4-912065-9	- - -9
						36.7	100	8-912066-2	- - -8
			3	30	70	33.7	90	9-912066-6	- - -7
	OBSOLETE	NOT AVAILABLE	5	50	43	30.7	80	9-912066-3	- - -6
	ACTIVE	AVAILABLE				27.7	70	912063-1	- - -5
	OBSOLETE	NOT AVAILABLE				24.7	60	9-912066-5	- - -4
	ACTIVE	AVAILABLE				21.7	50	9-912062-9	- - -3
	OBSOLETE	NOT AVAILABLE				18.7	40	9-912066-4	- - -2
	OBSOLETE	NOT AVAILABLE	5	50	43	15.7	30	9-912066-3	- - -1

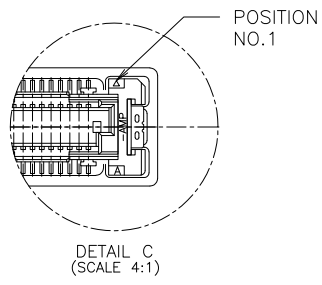
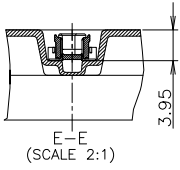

THIS DRAWING IS A CONTROLLED DOCUMENT.

DWN T.KUSUHARA 11MAY95
 CHK I.NENOMOTO 19MAY95
 APVD I.NENOMOTO 19MAY02

Tyco Electronics Tyco Electronics Corporation
 Kawasaki, Japan

SOFT TRAY ASSY
 FH 0.6BTB CONNECTOR
 PLUG 4H STD

PRODUCT SPEC 製品規格
 108-5468
 APPLICATION SPEC 取付適用規格

SIZE A3 CAGE CODE 00779 DRAWING NO. 番号 316135

WEIGHT 重量
 MATERIAL 材料 FINISH 仕上

CUSTOMER DRAWING SCALE 尺度 1:2 SHEET 1 OF 2 REV J

THIS DRAWING IS UNPUBLISHED. RELEASED FOR PUBLICATION MAY, 1995.
 © COPYRIGHT 1995 BY TYCO ELECTRONICS CORPORATION. ALL RIGHTS RESERVED.

LOC	DIST	REVISIONS			
P	LTR	DESCRIPTION	DATE	DWN	APVD
-	-	SEE SHEET 1	-	-	-

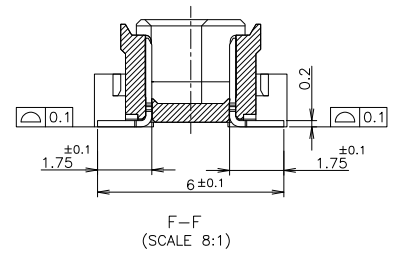
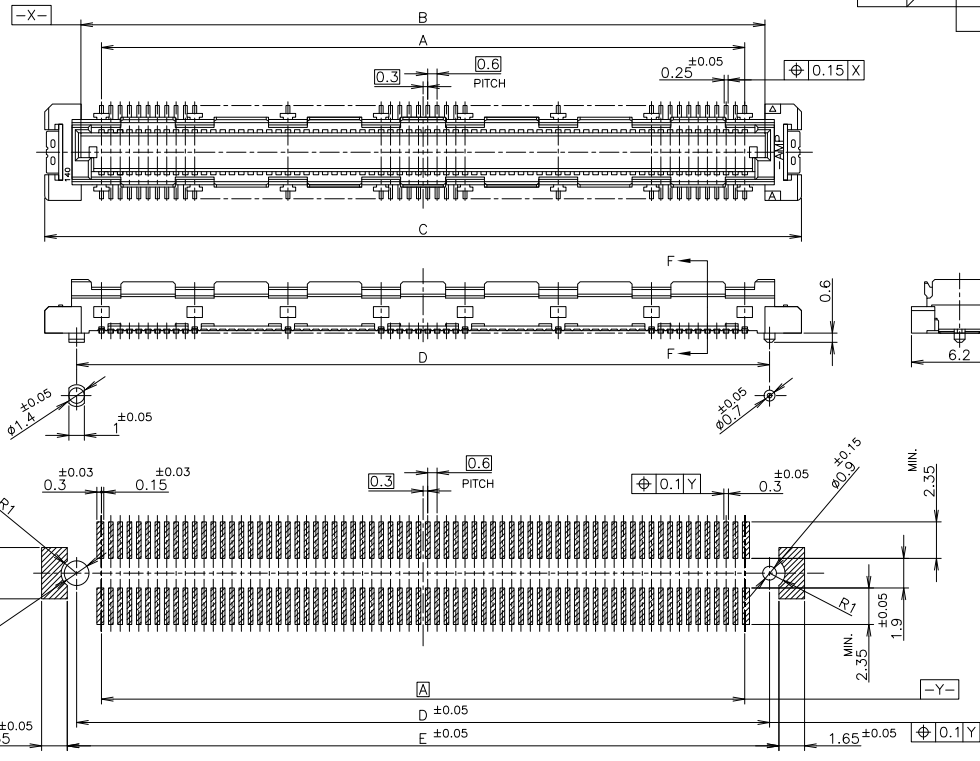

△ MATERIAL ; HOUSING : HIGH TEMP THERMO PLASTIC
 UL94V-0
 CONTACT : COPPER ALLOY
 △ FINISH ; UNDER PL Ni 0.0013mm MIN ALL OVER.
 CONTACT AREA 0.0002 MIN Au PL.
 SOLDERING AREA 0.001 MIN Sn-Pb

REFERENCE P.C.BOARD LAYOUT

ACTIVE	AVAILABLE	51.8	50.6	54.7	50	47.4	160
ACTIVE	AVAILABLE	45.8	44.6	48.7	44	41.4	140
OBSOLETE	NOT AVAILABLE	39.8	38.6	42.7	38	35.4	120
ACTIVE	AVAILABLE	33.8	32.6	36.7	32	29.4	100
OBSOLETE	NOT AVAILABLE	30.8	29.6	33.7	29	26.4	90
OBSOLETE	NOT AVAILABLE	27.8	26.6	30.7	26	23.4	80
ACTIVE	AVAILABLE	24.8	23.6	27.7	23	20.4	70
ACTIVE	AVAILABLE	21.8	20.6	24.7	20	17.4	60
ACTIVE	AVAILABLE	18.8	17.6	21.7	17	14.4	50
OBSOLETE	NOT AVAILABLE	15.8	14.6	18.7	14	11.4	40
OBSOLETE	NOT AVAILABLE	12.8	11.6	15.7	11	8.4	30
STATUS	TOOLING STATUS	E	D	C	B	A	POS

THIS DRAWING IS A CONTROLLED DOCUMENT.

DIMENSIONS: 単位: 概 mm	TOLERANCES UNLESS OTHERWISE SPECIFIED: 数公差	DWN	Tyco Electronics Tyco Electronics Corporation Kawasaki, Japan	
	0 PLC ± 0.3 1 PLC ± 0.3 2 PLC ± 0.3 3 PLC ± 0.3 4 PLC ± 0.3 ANGLES ± 3°	CHK	NAME 名称	SOFT TRAY ASSY FH 0.6BTB CONNECTOR PLUG 4H STD
MATERIAL 材料	FINISH 仕上	APVD	PRODUCT SPEC 製品規格	SIZE CAGE CODE DRAWING NO 番号
		APPLICATION SPEC 取付適用規格	WEIGHT	A3 00779 C-316135
		CUSTOMER DRAWING	SCALE 尺度	4:1 SHEET 2 OF 2 REV J

AMP 1470-19 REV 31MAR2000