

50 PIN COMPACT FLASH SOCKET STRADDLE MOUNT

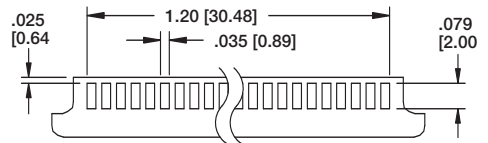

Recommended PCB Layout

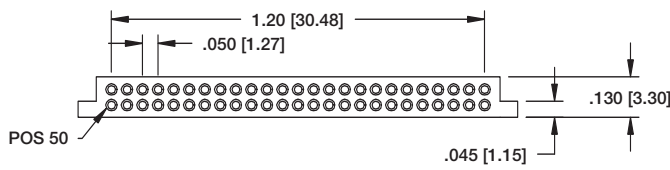
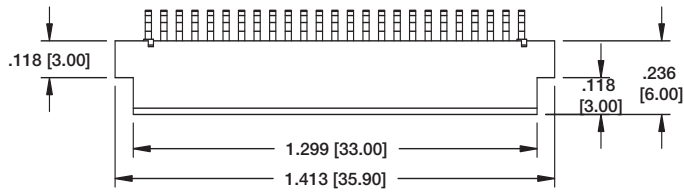
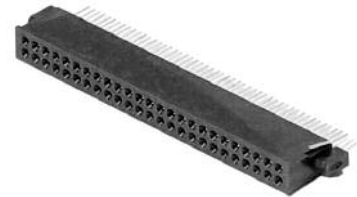

CFS-50-A-SG-SM

50 PIN COMPACT FLASH SOCKET SURFACE MOUNT

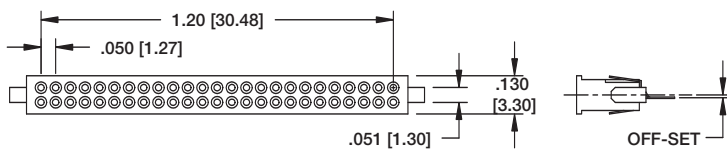
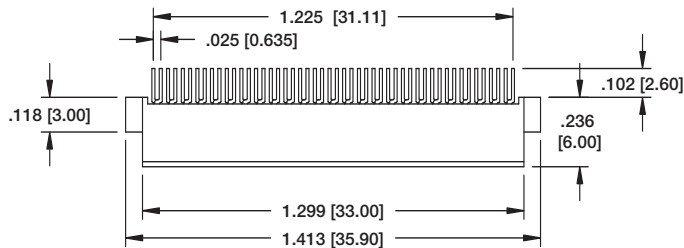

Recommended PCB Layout

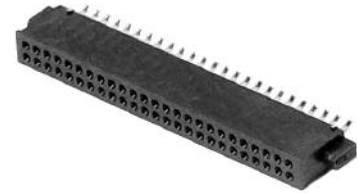

- Part Nos. Available
 CFS-50-A-SG-SMT-A (No offset)
 CFS-50-A-SG-SMT-B (0.3mm offset)
 CFS-50-A-SG-SMT-C (0.6mm offset)
 CFS-50-A-SG-SMT-D (0.9mm offset)

68 PIN COMPACT FLASH SOCKET STRADDLE MOUNT

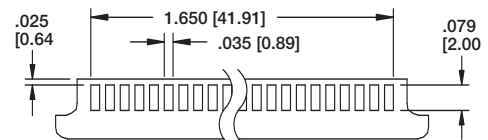
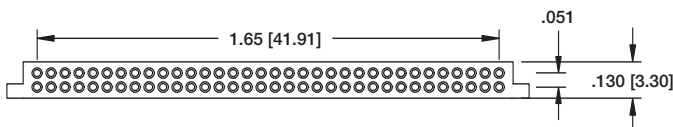
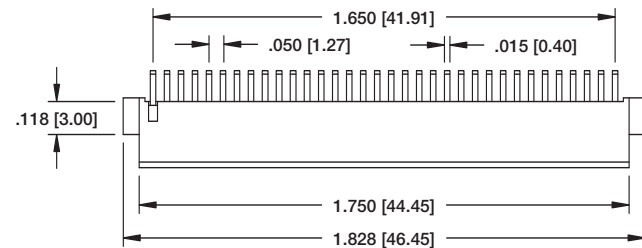

Recommended PCB Layout

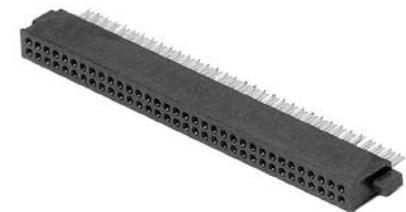

CFS-68-A-SG-SM

50 PIN COMPACT FLASH, TYPE 1

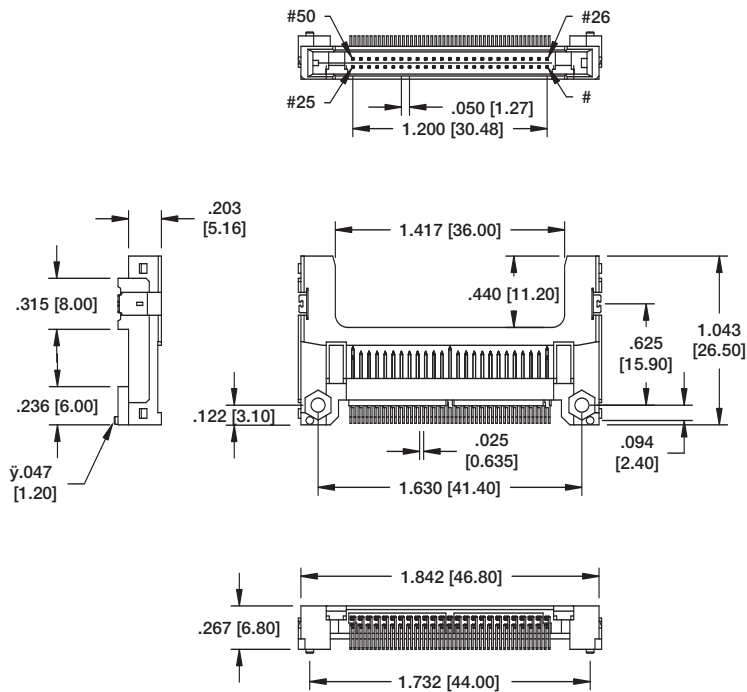

Part Nos. Available
CF1-50-A-SG (Standard Type)
CF1R-50-A-SG (Reverse Type) Not Shown

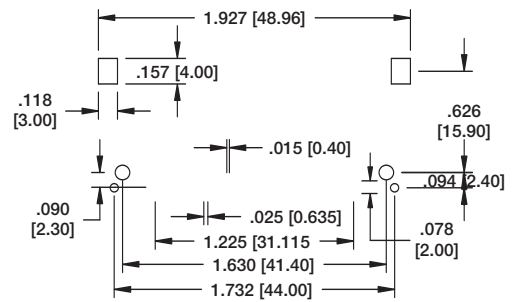

50 PIN COMPACT FLASH, EJECTOR (FOR USE WITH CF1 AND CF1R SERIES SOCKETS)

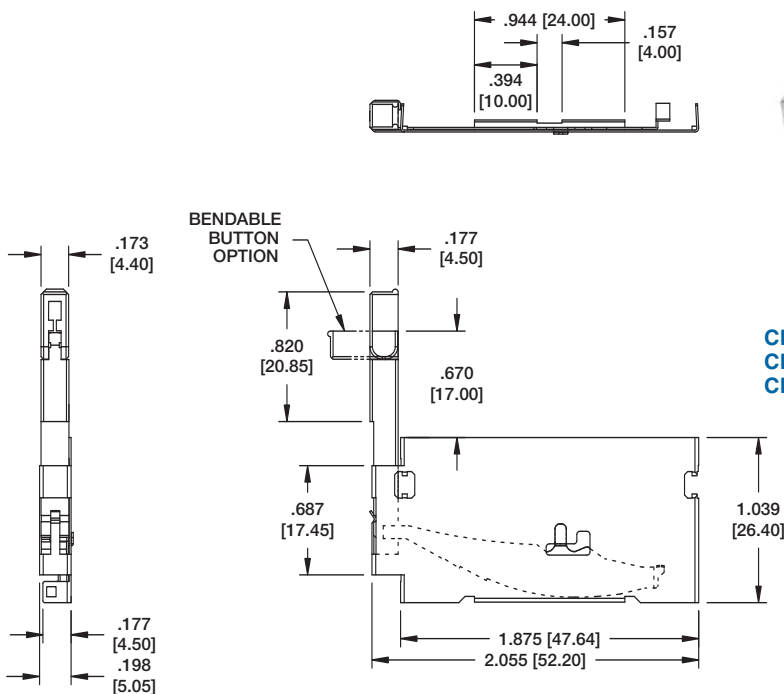

Part Nos. Available
CFE-50-L15 (15.0mm long Ejector button)
CFE-50-L20 (20.0mm long Ejector button)
CFE-50-L22 (22.0mm long Ejector button)
CFEB-50-L15 (15.0mm long bendable Ejector button)
CFEB-50-L20 (20.0mm long bendable Ejector button)
CFEB-50-L22 (22.0mm long bendable Ejector button)

| DIM X |
|---------------|
| 1.581 [40.16] |
| 1.525 [38.74] |

ALSO AVAILABLE WITH EJECTOR

**50 PIN COMPACT FLASH,
SLIM TYPE (FITS CF TYPE 1 AND 2)**

CFA-50-A-SG-B-1

Part Nos. Available

- CFA-50-A-SG-1 (Standard Type, 40.16mm)
- CFA-50-A-SG-B-1 (Standard Type, 40.16mm, Standoff 1.2mm)
- CFR-50-A-SG-1 (Reverse Type, 40.16mm)
- CFR-50-A-SG-C-1 (Reverse Type, 40.16mm, Standoff 1.4mm)
- CFA-50-A-SG-2 (Standard Type, 38.74mm)
- CFA-50-A-SG-B-2 (Standard Type, 38.74mm, Standoff 1.2mm)
- CFR-50-A-SG-2 (Reverse Type, 38.74mm)
- CFR-50-A-SG-C-2 (Reverse Type, 38.74mm, Standoff 1.4mm)

**50 PIN COMPACT FLASH,
SHORT SLIDE TYPE (FITS TYPE 2)**

CF-50-C-SG