

3M™ DIP Socket

Screw Machine, Closed Body

ICA Series

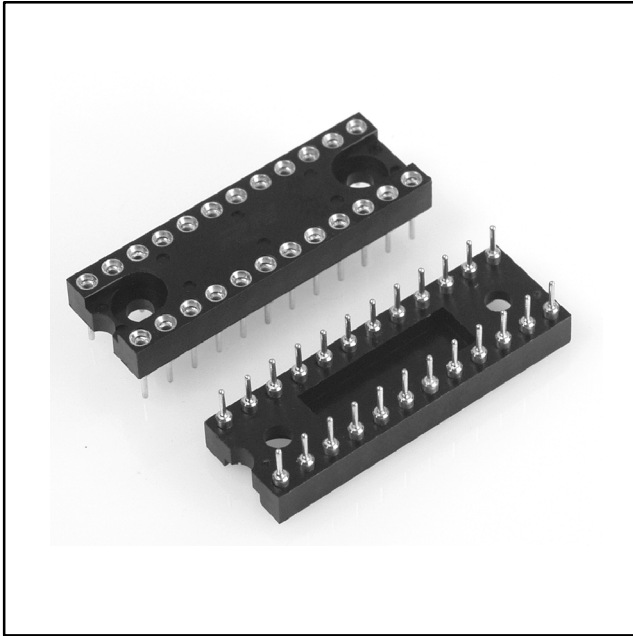

- High retention pin sockets prevent “IC walk-out during heavy vibration
- Pin socket design prevents solder wicking and flux entrapment
- Four-finger beryllium copper contacts provide low, stable contact resistance and accept short IC leads
- Side and end stackable

Date Modified: July 21, 200

TS 100-03
Sheet 1 of 4

Physical

Insulation

Material: Black Polyester Glass Filled
Flammability: UL 94V-0
Color: Black

Contact

Shell Material: Half Hard Brass
Clip Material: Beryllium Copper

Plating

Underplating: 50 μ " [1.27 μ m] min. Nickel
Wiping Area: See Ordering Information
Terminal Area: 200 μ " [5.08 μ m] min. Tin/Lead

Insertion / Removal Forces:

Insertion Force: 12 ounces max per contact*
Withdrawal Force: 1.5 [ounces] min. per contact using .017" [0.43 mm] dia. pin
(Average of 2nd 3rd and 4th Cycle)

Electrical

Current Rating: 1.0 A

Contact Resistance: 20 m Ω max.

Dielectric Withstanding Voltage: 500V AC for 1 minute

Insulation Resistance: 5,000 M Ω min. at 500V DC

Withstanding Voltage: 650V AC for 1 minute

Capacitance: 1 pF max.

Environmental

Temperature Rating: -65°C to +125°C

UL File No.: E68080

3M
Interconnect Solutions
<http://www.3M.com/interconnects/>

3M is a trademark of 3M Company.
For technical, sales or ordering information call
800-225-5373

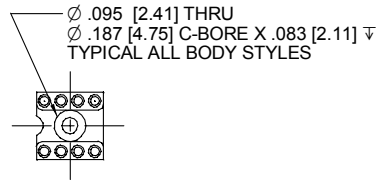

Body Style "A"

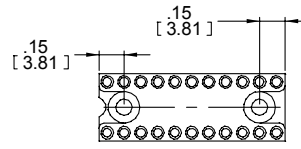

Body Style "B"

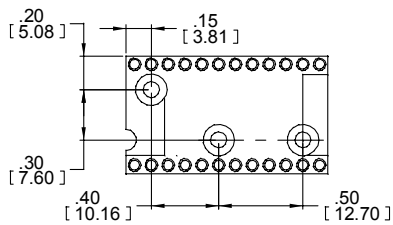

Body Style "C"

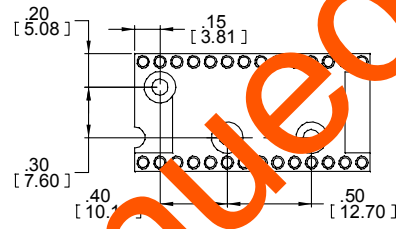

Body Style "D"

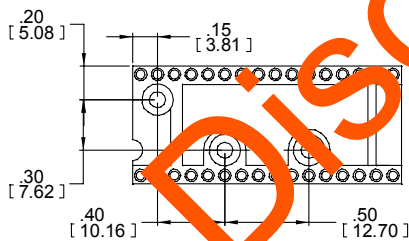

Body Style "E"

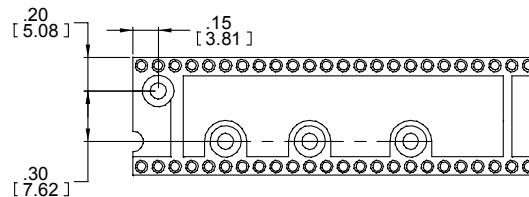

Body Style "F"

Discontinued

Inch
[mm]

Tolerance Unless Noted			
	.0	.00	.000
Inch	± .1	± .01	± .005

[] Dimensions for Reference only

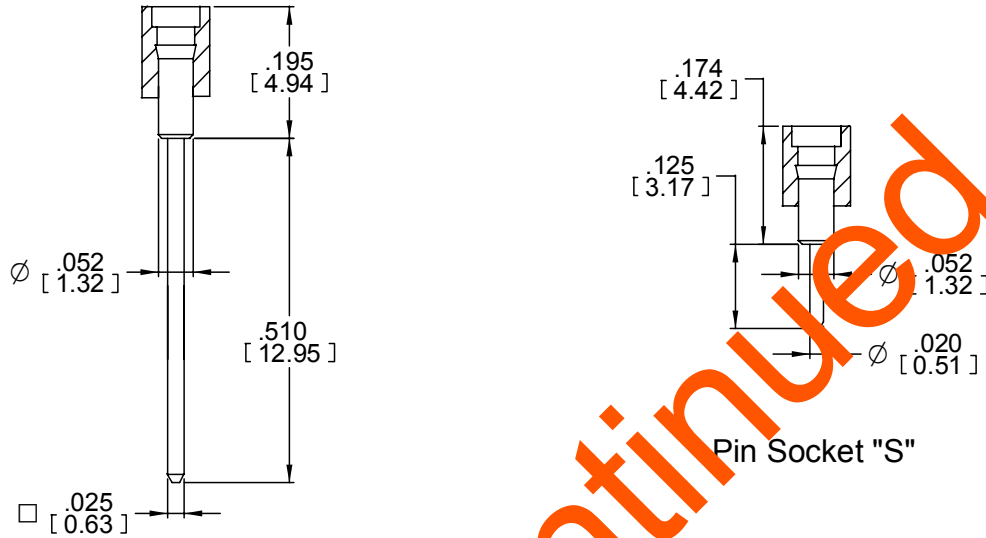

Pin Socket "WB"

Pin Socket "S"



Discontinued

Pin socket Style	Plating option Available
S	TG
S	TG30
S	TT
WB	TG30

Inch [mm]			
Tolerance Unless Noted			
	.0	.00	.000
Inch	± .1	± .01	± .005

[] Dimensions for Reference only

Acceptable Pin Sizes

Diameter: .016" - .021" [0.41 mm - 0.53 mm]

Length: .110" - .150" [2.79 mm - 3.81 mm]

Mounting Information

.025"[0.635mm] Square Pin .040" ± .002" [1.1 mm ± 0.05 mm] dia. PCB hole

.020" [0.51 mm] Dia. Pin: .030" ± .002" [0.76 mm ± 0.05 mm] dia. PCB hole

Contact Quantity	Description	Dimension A	Dimension B	Dimension C	Body Style
6	ICA-063-XXX-XXXX	0.295 [7.49]	.300 [7.62]	.395 [10.03]	A
8	ICA-083-XXX-XXXX	.395 [10.03]	.300 [7.62]	.395 [10.03]	A
14	ICA-143-XXX-XXXX	.695 [17.65]	.300 [7.62]	.395 [10.03]	B
16	ICA-163-XXX-XXXX	.795 [20.19]	.300 [7.62]	.395 [10.03]	B
18	ICA-183-XXX-XXXX	.895 [22.73]	.300 [7.62]	.395 [10.03]	B
20	ICA-203-XXX-XXXX	.995 [25.27]	.300 [7.62]	.395 [10.03]	B
24	ICA-243-XXX-XXXX	1.195 [30.35]	.300 [7.62]	.395 [10.03]	B
24	ICA-246-XXX-XXXX	1.195 [30.35]	.600 [15.24]	.695 [17.65]	C
28	ICA-286-XXX-XXXX	1.395 [35.43]	.600 [15.24]	.695 [17.65]	D
32	ICA-326-XXX-XXXX	1.595 [40.51]	.600 [15.24]	.695 [17.65]	E
40	ICA-406-XXX-XXXX	1.995 [50.67]	.600 [15.24]	.695 [17.65]	F

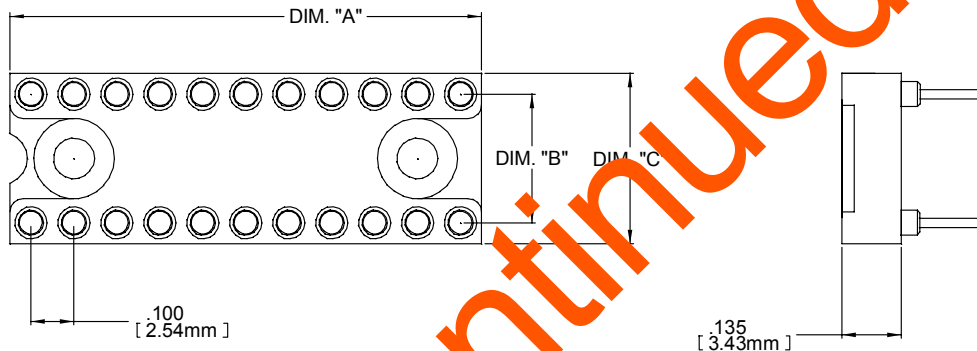

Discontinued



Inch
[mm]

Tolerance Unless Noted			
	.0	.00	.000
Inch	± .1	± .01	± .005

[] Dimensions for Reference only

Ordering Information

ICA - XX X - XXXX - X

Contact Quantity
(See Table)

Row Spacing:
3 = .300 [7.62]
6 = .600 [15.24]
(See Table)

Lead Style:
S
WB

Plating Options:
TG = 10 μ" [0.25 μm] min. Gold
TG30 = 30 μ" [0.76 μm] min. Gold
TT = 150 μ" [3.81 μm] min. Tin/Lead
See chart for pin socket plating offerings

Important Notice

All statements, technical information, and recommendations related to 3M's products are based on information believed to be reliable, but the accuracy or completeness is not guaranteed. Before using this product, you must evaluate it and determine if it is suitable for your intended application. You assume all risks and liability associated with such use. Any statements related to the product which are not contained in 3M's current publications, or any contrary statements contained on your purchase order shall have no force or effect unless expressly agreed upon, in writing, by an authorized officer of 3M.

3M

3M Electronics

6801 River Place Blvd.
Austin, TX 78726-9000
800/225-5373
www.3M.com/electronics

Warranty; Limited Remedy; Limited Liability.

This product will be free from defects in material and manufacture for a period of one (1) year from the time of purchase. **3M MAKES NO OTHER WARRANTIES INCLUDING, BUT NOT LIMITED TO, ANY IMPLIED WARRANTY OF MERCHANTABILITY OR FITNESS FOR A PARTICULAR PURPOSE.** If this product is defective within the warranty period stated above, your exclusive remedy shall be, at 3M's option, to replace or repair the 3M product or refund the purchase price of the 3M product. **Except where prohibited by law, 3M will not be liable for any indirect, special, incidental or consequential loss or damage arising from this 3M product, regardless of the legal theory asserted.**



Minimum 10%
Post-Consumer Fiber

Printed in USA.

© 3M 2006