

PRODUCT NUMBER
SEE SHT. 2

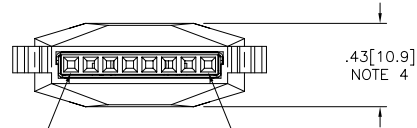
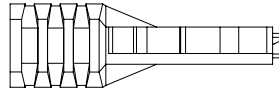
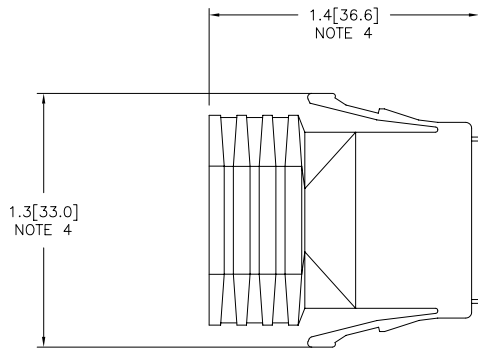

POSTION #1 POSTION #8

mat'l. code		surface	tolerance	projection	product family
		ISO 1302	ISO 406		LATCH-N-LOK
			ISO 1101		title
ltr	ecn no	dr	date	tolerances unless otherwise specified	
D	v91916	TGD	10/7/99	.XX±.01/.3	
E	v92065	RGD	10/29/99	angles linear .XXX±.005/.13	1x8 LATCH-N-LOK 360° SHIELDED
F	v01017	TFG	5/15/00	0°±2° .XXXX±.0020/.051	PLUG CONN. KIT W/O PV'S
G	v01050	TFG	6/5/00	dr M. HERNANDEZ 12/03/04	scale 1:1
H	v01093	TFG	7/6/00	engr M. BARRIOS 12/03/04	
J	M04-0229	MHT	12/03/04	chr M. BARRIOS 12/03/04	
K	M06-0365	AGS	9/20/06	appd M. BARRIOS 12/03/04	dwg no
sheet	revision	K	K	K	74903
index	sheet	1	2	3	sheet 1 of 3 size
					A3
					type Product Customer Drawing

74903-TUVLF

U	COLOR	
01	LT GRAY	OBS
02	OFF WHITE	
03	DK GRAY	OBS
04	BLACK	
05	SLATE GRAY	OBS
07	SILVER GRAY	
08	PEARL WHITE	OBS
09	PEBBLE GRAY	

T	HOLE DIA.
7	.265/6.73
9	.312/7.92

EXAMPLE

74903-707LF: IS A 1x8 REAR EXIT PLUG IN SILVER GRAY WITH A CABLE EXIT HOLE SIZE OF .265 [6.73] CABLE RANGE ,

mat'l. code		surface	tolerance	projection	product family
ISO 1302		ISO 1302	ISO 406		LATCH-N-LOK
ISO 1101		ISO 1101	ISO 1101		
ltr	ecn	no	dr	date	title
K					1x8 LATCH-N-LOK 360° SHIELDED PLUG CONN. KIT W/O PV'S
		tolerances unless otherwise specified			
		angles	linear		scale 1:1
		0°±2'	.XX±.01/.3		
			.XXX±.005/.13		
			.XXXX±.0020/.051		
		dr	M. HERNANDEZ	12/03/04	dwg no
		engr	M. BARRIOS	12/03/04	74903
		chr	M. BARRIOS	12/03/04	sheet 2 of 3
		appd	M. BARRIOS	12/03/04	size
					A3
sheet		revision			type
index	sheet				Product Customer Drawing

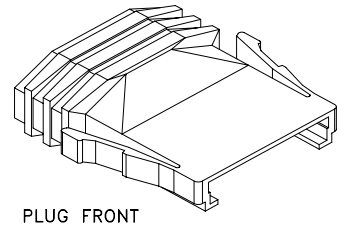
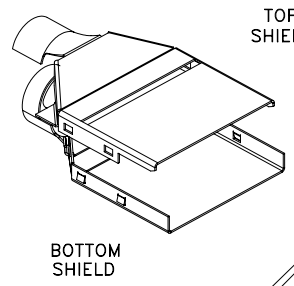
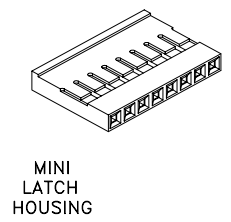
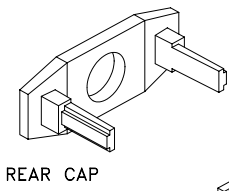

NOTES:

- ① EACH KIT CONTAINS ONE EACH OF THE FOLLOWING COMPONENTS
LATCH-N-LOK PLUG
LATCH-N-LOK END CAP
MINI LATCH HOUSING
360° SHIELD CANS.
- 2. COMPONENTS ARE BULK PACKAGED WITH 100 pcs. OF A COMPONENT PER BAG. PVC'S MUST BE ORDERED SEPARATELY.
- 3. MATERIALS USED: PLUGS AND CAPS ARE MOLDED IN POLYCARBONATE. THE MINI LATCH HOUSING ARE MOLDED IN NYLON. COLOR IS BLACK. THE SHIELD CAN IS 3/4 HARD BRASS PLATED WITH 2.5um MIN. BRIGHT TIN. 1.0um MIN. NICKEL UNDERPLATE.
- ④ DIMENSIONS ARE APPROXIMATE AND REFLECT PLUG IN UNLATCHED STATE.
- 5. PART NUMBERS WITH LF IN THE END ARE LEAD FREE.
- 6. THIS PRODUCT MEETS EUROPEAN UNION DIRECTIVES AND OTHER COUNTRY REGULATION AS DESCRIBED IN GS-22-008.

FCJ
 FCconnect.com
 Copyright FCJ

mat'l. code		surface	tolerance	projection	product family
ISO 1302		ISO 406	ISO 1101		LATCH-N-LOK
ltr	ecn no dr date	tolerances unless otherwise specified			title
K		angles	.XX±.01/.3	INCH/MM	1X8 LATCH-N-LOK 360° SHIELDED PLUG CONN. KIT W/O PV'S
		linear	.XXX±.005/.13	scale 1:1	dwg no 74903 sheet 3 of 3 size A3
		0°±2"	.XXXX±.0020/.051		type Product Customer Drawing
		dr	M. HERNANDEZ 12/03/04		
		engr	M. BARRIOS 12/03/04		
		chr	M. BARRIOS 12/03/04		
		appd	M. BARRIOS 12/03/04		
sheet index	revision sheet				