

# 1.7mm PCB DC Jack

163-4311

**KOBI**CONN

1.7mm PCB DC Jack

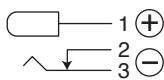
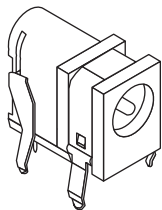

Circuit Diagram

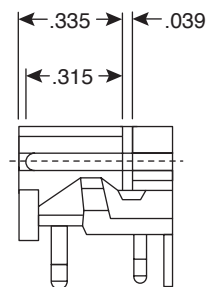
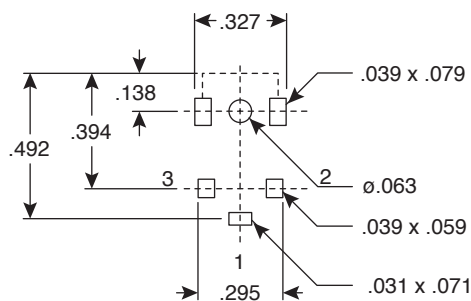
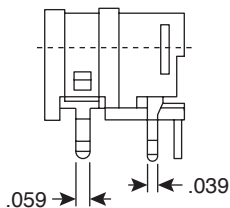
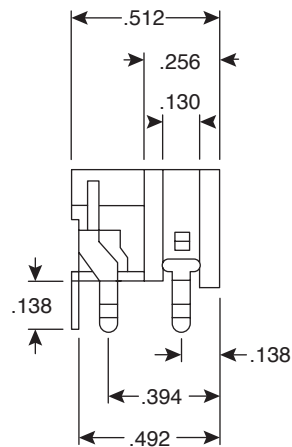
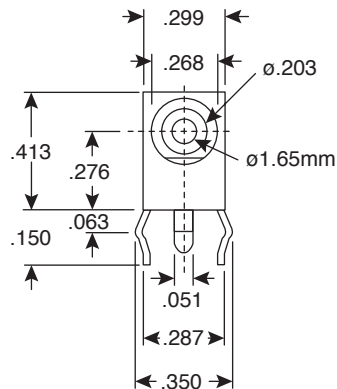

**DIMENSIONS: (In.)**  
(except where noted)

SPECIFICATIONS	
Type:	1.7mm DC power
Rated power:	6.3VDC~10.5VDC @ 2A
Dielectric strength:	500VAC for 1 minute
Insulation resistance:	100MΩ min. @ 500VDC
Contact resistance:	30mΩ max.
Center and support terminals:	tin plated brass
Terminals:	silver plated brass
Body:	PBT
Center pin:	nickel plated brass
Spring:	piano wire

Date Last Revised: 10-14-05

Available from Mouser Electronics  
1-800-346-6873  
www.mouser.com

KC-300383

163-4311