

**INTRODUCTION:**

Adam Tech ADC Series DC Power Jacks are a complete line of miniature and sub-miniature power jacks primarily used for the transmission of wall current transformed to DC power, for detached and hand held instruments. Adam Tech power jacks are manufactured with a variety of center pin sizes for all standard applications including 1.00mm, 1.30mm, 2.00mm and 2.50mm. Our contact is designed using a wide spring grade plated copper alloy for exceptional plug retention and low contact resistance.

**FEATURES:**

- Low Profile designs
- Superior contact system
- Exceptional plug retention
- Choice of Center pin sizes
- Hi Temp Versions
- Hi Current Versions

**MATING PLUGS:**

All industry standard 1.00mm, 1.30mm, 2.00mm, 2.35mm and 2.50mm Plugs.

**SPECIFICATIONS:**

**Material:**

Standard insulator: PBT Glass reinforced, rated UL94V-0  
 Optional Hi-Temp insulator: Nylon 6T, rated UL94V-0  
 Insulator Color: Black  
 Center Pin: Brass, Nickel plated  
 Contacts: Copper alloy

**Contact Plating:**

Silver over nickel underplate

**Electrical:**

Operating voltage: 12V DC max.  
 Current rating: 1 Amp max.  
 Contact resistance: 30 mΩ max. initial  
 Insulation resistance: 50 MΩ min.  
 Dielectric withstanding voltage: 250V AC for 1 minute

**Mechanical:**

Insertion force: 3 kg max.  
 Withdrawal force: 0.3 kg min  
 Mating durability: 5000 cycles min.

**Temperature Rating:**

Operating temperature: -25°C to +85°C  
 Soldering process temperature:  
     Standard insulator: 235°C  
     Hi-Temp insulator: 260°C

**PACKAGING:**

Anti-ESD plastic bags or Tape and Reel

**APPROVALS AND CERTIFICATIONS:**

UL Recognized & CSA Certified, File no. E224053



**ORDERING INFORMATION**

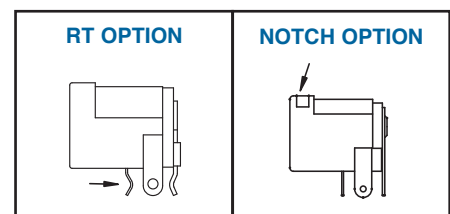
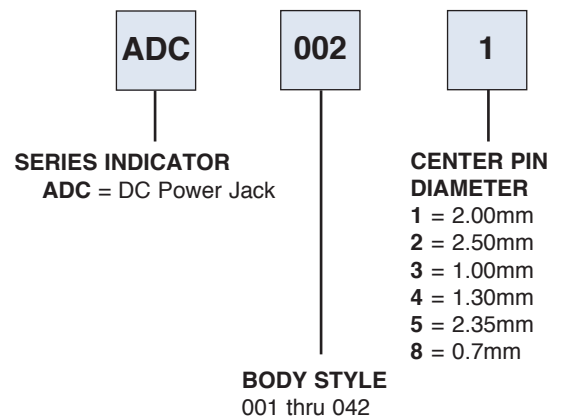

**OPTIONS:**

- Add designator(s) to end of part number
- RT** = PC Board Retention Feature (Type 007 & 009 only)
- HT** = Hi-Temp insulator for Hi-Temp soldering processes up to 260°C
- N** = Notch option, (ADC-002 only)
- ADCH** = DC Power Jack Hi-Current 5 Amp Version

#### ADC-007



ADC-007-3

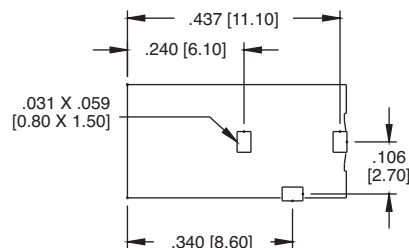
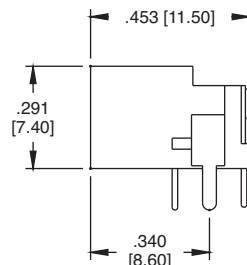
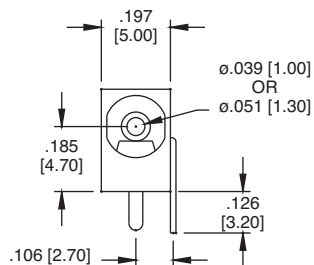

Recommended PCB Layout

#### ADC-009



ADC-009-3

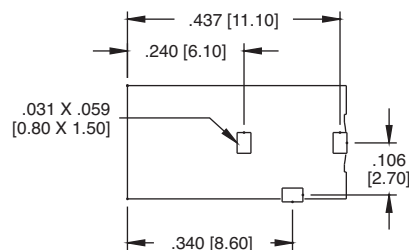
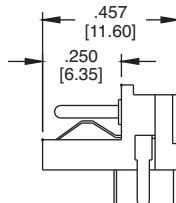
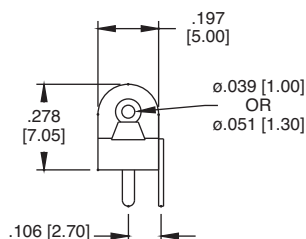

Recommended PCB Layout

#### ADC-011



ADC-011-3

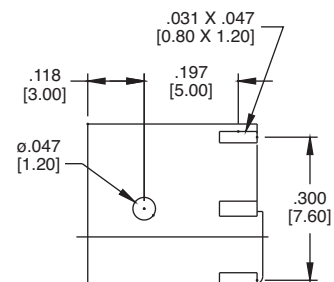
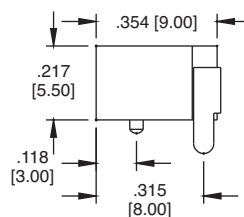
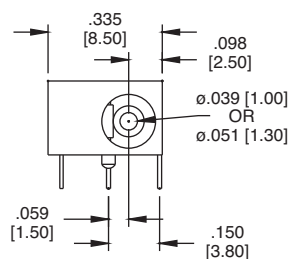

Recommended PCB Layout

#### ADC-021



ADC-021-3

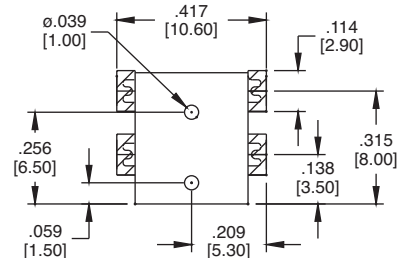
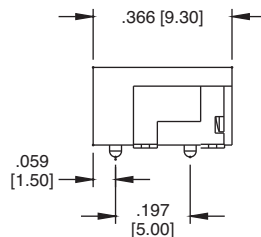
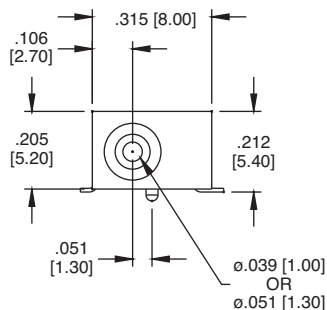

Recommended PCB Layout

## ADC-029



ADC-029-1

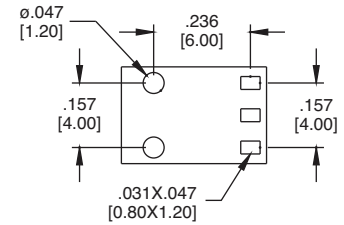
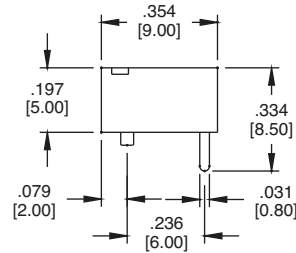
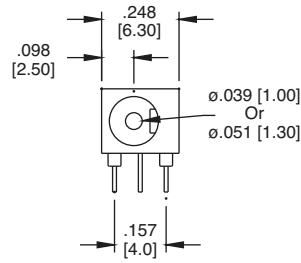

Recommended PCB Layout

## ADC-002



ADC-002-2

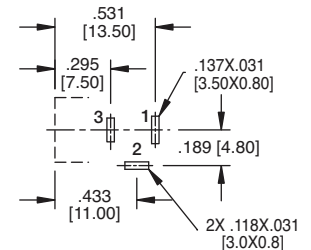
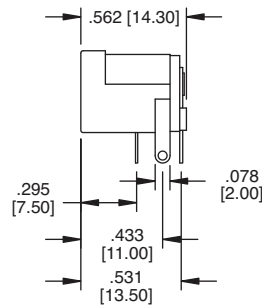
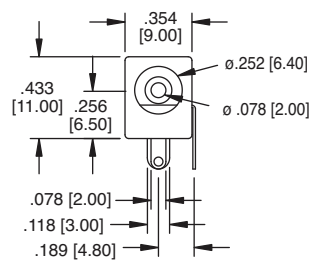

Recommended PCB Layout

## ADC-024



ADC-024-8

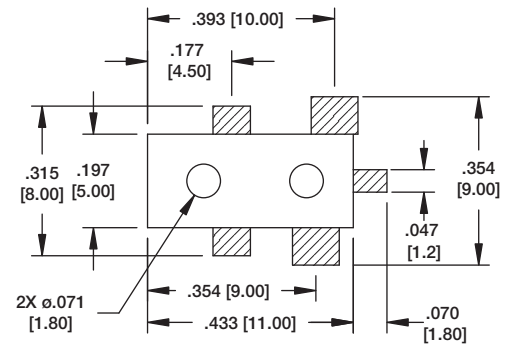
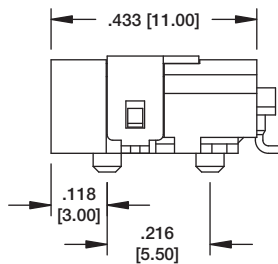
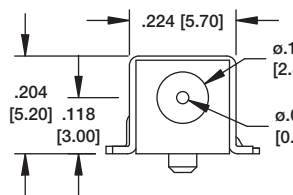

Recommended PCB Layout

## ADC-028



ADC-028-2

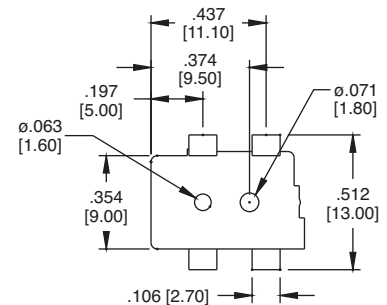
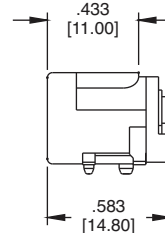
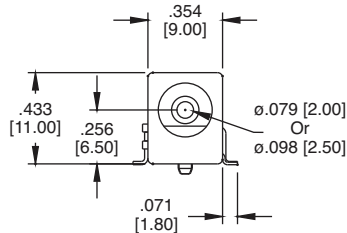

Recommended PCB Layout

#### ADC-027



ADC-027



ADC-027-M8

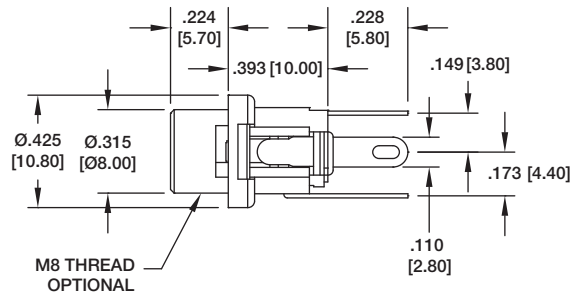
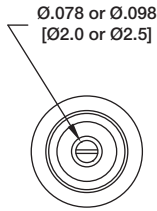

#### ADC-085



ADC-085-1

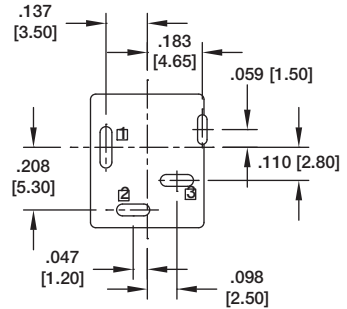
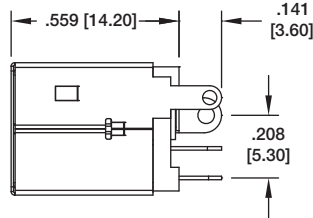
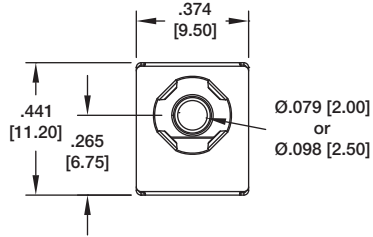

Recommended PCB Layout

#### ADC-086



ADC-085-2

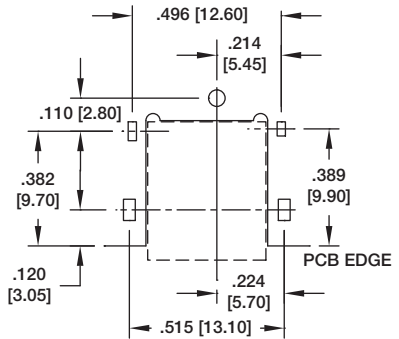
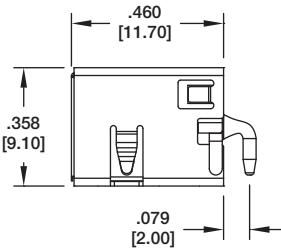
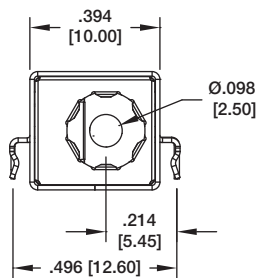

Recommended PCB Layout

#### ADC-087



ADC-087

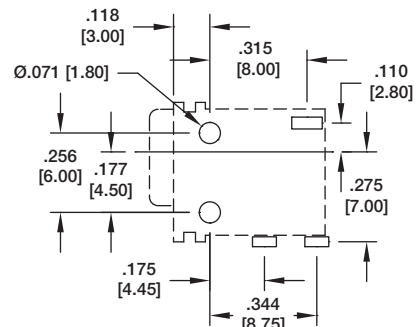
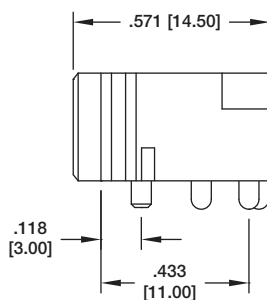
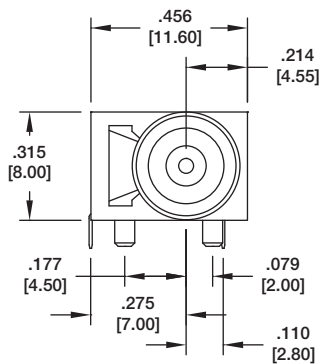

Recommended PCB Layout

## ADC-010



ADC-010-1

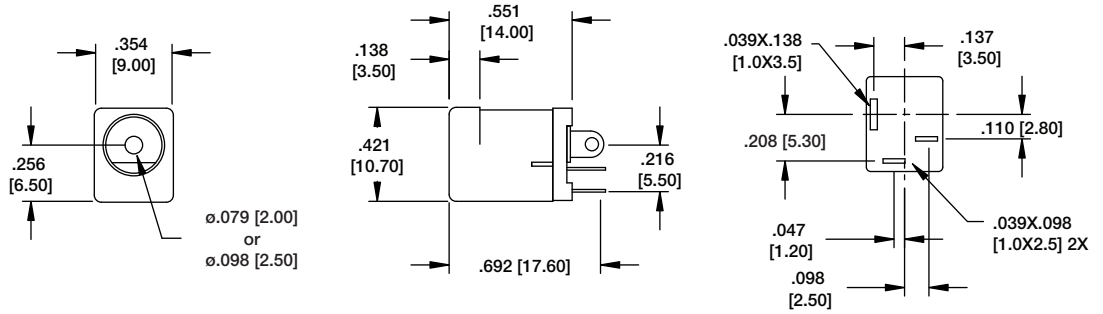

Recommended PCB Layout

## ADC-015



ADC-015-2

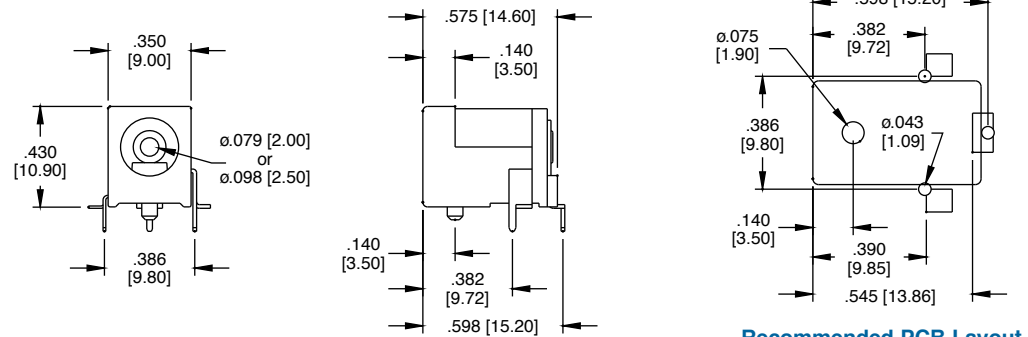

Recommended PCB Layout

## ADC-045A



ADC-045A-1

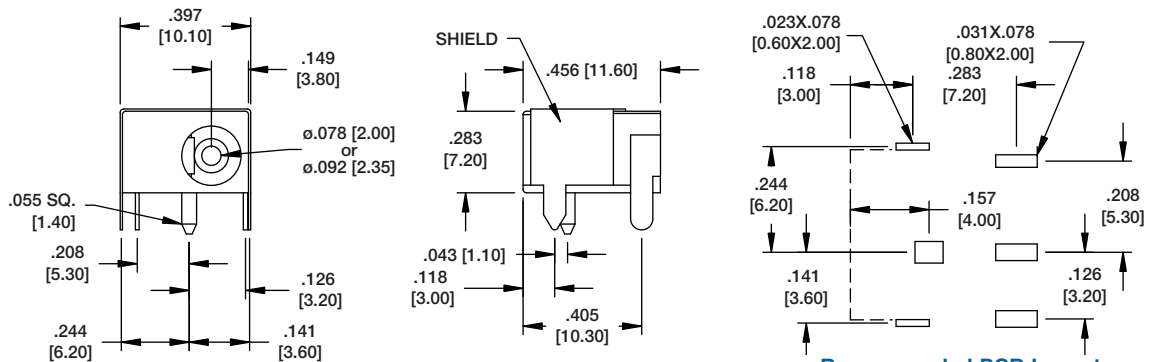

Recommended PCB Layout

## ADP-PLUG WITH STRAIN RELIEF

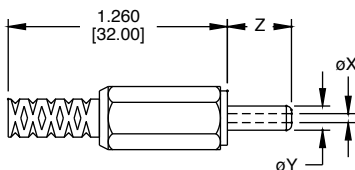

## ADP-PLUG WITHOUT STRAIN RELIEF

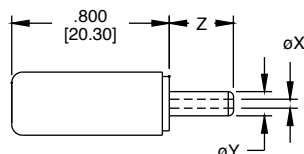

PLUG WITH STRAIN RELIEF	X	Y	Z
ADP-X/Y/Z-SR	ø.039 [1.00]	ø.137 [3.50]	.374 [9.50]
ADP-X/Y/Z-SR	ø.082 [2.10]	ø.216 [5.50]	.374 [9.50]
ADP-X/Y/Z-SR	ø.098 [2.50]	ø.216 [5.50]	.374 [9.50]

PLUG WITHOUT STRAIN RELIEF	X	Y	Z
ADP-X/Y/Z	ø.039 [1.00]	ø.137 [3.50]	.374 [9.50]
ADP-X/Y/Z	ø.082 [2.10]	ø.216 [5.50]	.374 [9.50]
ADP-X/Y/Z	ø.098 [2.50]	ø.216 [5.50]	.374 [9.50]