

# MIL-DTL-83513/22 Thru /27 Micro-D Connectors Straight PCB Connectors (BS)

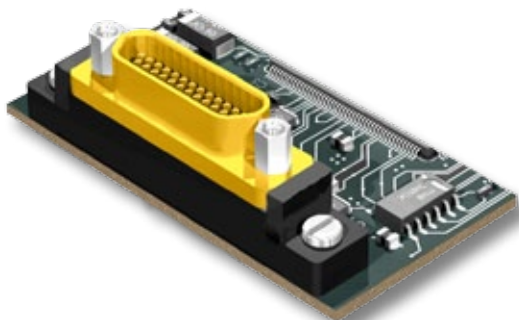

Micro-D  
MIL-DTL-83513



**High Performance** — These connectors feature goldplated TwistPin contacts for best performance. PC tails are .020 inch diameter. Specify nickel-plated shells or cadmium plated shells for best availability.

**Solder-Dipped** — Terminals are coated with SN63/Pb37 tin-lead solder for best solderability.

## HOW TO ORDER M83513/22 THRU /27 STRAIGHT PCB CONNECGTORS

Spec Number	Slash Number- Insert Arrangement	PC Tail Length	Shell Finish	Hardware Option	
<b>M83513/</b>	<b>Plug (Pin Contacts)</b>	<b>01</b> - .109 Inch (2.77 mm)	<b>C</b> - Cadmium	<b>N</b> - No Jackpost	
	<b>22-A</b> - 9 Contacts	<b>02</b> - .140 Inch (3.56 mm)	<b>N</b> - Electroless Nickel	<b>P</b> - Jackposts Installed	
	<b>22-B</b> - 15 Contacts	<b>03</b> - .172 Inch (4.37 mm)	<b>P</b> - Passivated SST	<b>T</b> - Threaded Insert in Board Mount Hole (No Jackposts)	
	<b>22-C</b> - 21 Contacts			<b>W</b> - Threaded Insert in Board Mount Hole and jackposts Installed	
	<b>22-D</b> - 25 Contacts	PC Tail Length ± .015 (0.38)		(See "Hardware Options" below for Illustrations)	
	<b>22-E</b> - 31 Contacts			Shell sizes A (9) through G (51) are #2-56 UNC-2 threads.	
	<b>22-F</b> - 37 Contacts			Shell size H (100) is #4-40 UNC-2 threads.	
	<b>23-G</b> - 51 Contacts				
	<b>24-H</b> - 100 Contacts				
	<b>Receptacle (Socket Contacts)</b>				
	<b>25-A</b> - 9 Contacts				
	<b>25-B</b> - 15 Contacts				
	<b>25-C</b> - 21 Contacts				
	<b>25-D</b> - 25 Contacts				
	<b>25-E</b> - 31 Contacts				
	<b>25-F</b> - 37 Contacts				
<b>26-G</b> - 51 Contacts					
<b>27-H</b> - 100 Contacts					
<b>Sample Part Number</b>					
<b>M83513/</b>	<b>26-G</b>	<b>03</b>	<b>C</b>	<b>W</b>	

## HARDWARE OPTIONS

N	P	T	W
No Jackpost	Jackpost	Threaded Insert	Jackpost, Threaded Insert



MIL-DTL-83513/22 Thru /27 Micro-D Connectors  
Straight PCB Connectors (BS)

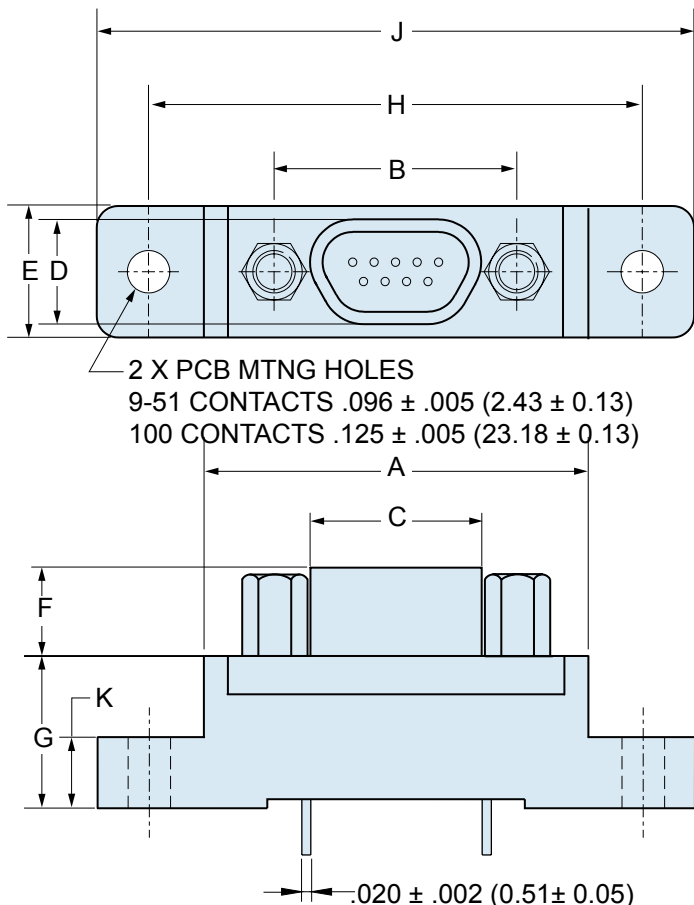

THREAD SIZES  
9-51 CONTACTS #2-56 UNC  
100 CONTACTS #4-40 UNC

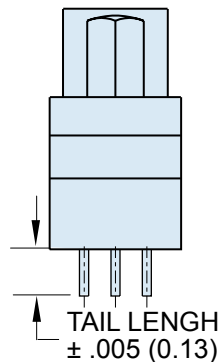

DIMENSIONS

Layout	A Max.		B		C Max.		D Max.		E Max.		F		G		H		J Max.		K	
	In.	mm.	In. ±.003	mm. ±.008	In.	mm.	In.	mm.	In.	mm.	In. ±.004	mm. ±.010	In. ±.010	mm. ±.025	In. ±.007	mm. ±.018	In.	mm.	In. ±.010	mm. ±.025
9P	.790	20.07	.565	14.35	.333	8.46	.184	4.67	.310	7.87	.183	4.65	.333	8.46	1.150	29.21	1.390	35.31	.155	3.94
9S	.790	20.07	.565	14.35	.400	10.16	.250	6.35	.310	7.87	.195	4.95	.333	8.46	1.150	29.21	1.390	35.31	.155	3.94
15P	.940	23.88	.715	18.16	.483	12.27	.184	4.67	.310	7.87	.183	4.65	.333	8.46	1.150	29.21	1.390	35.31	.155	3.94
15S	.940	23.88	.715	18.16	.551	14.00	.250	6.35	.310	7.87	.195	4.95	.333	8.46	1.150	29.21	1.390	35.31	.155	3.94
21P	1.180	29.97	.865	21.97	.633	16.08	.184	4.67	.310	7.87	.183	4.65	.333	8.46	1.450	36.83	1.690	42.93	.155	3.94
21S	1.180	29.97	.865	21.97	.701	17.81	.250	6.35	.310	7.87	.195	4.95	.333	8.46	1.450	36.83	1.690	42.93	.155	3.94
25P	1.275	32.39	.965	24.51	.733	18.62	.184	4.67	.310	7.87	.183	4.65	.333	8.46	1.500	38.10	1.740	44.20	.155	3.94
25S	1.275	32.39	.965	24.51	.801	20.35	.250	6.35	.310	7.87	.195	4.95	.333	8.46	1.500	38.10	1.740	44.20	.155	3.94
31P	1.575	40.01	1.115	28.32	.883	22.43	.184	4.67	.310	7.87	.183	4.65	.333	8.46	1.800	45.72	2.040	51.82	.155	3.94
31S	1.575	40.01	1.115	28.32	.951	24.16	.250	6.35	.310	7.87	.195	4.95	.333	8.46	1.800	45.72	2.040	51.82	.155	3.94
37P	1.875	47.63	1.265	32.13	1.033	26.24	.184	4.67	.310	7.87	.183	4.65	.333	8.46	2.100	53.34	2.340	59.44	.155	3.94
37S	1.875	47.63	1.265	32.13	1.101	27.96	.250	6.35	.310	7.87	.195	4.95	.333	8.46	2.100	53.34	2.340	59.44	.155	3.94
51P	1.775	45.09	1.215	30.86	.983	24.97	.228	5.79	.351	8.92	.183	4.65	.333	8.46	2.000	50.80	2.270	57.64	.155	3.94
51S	1.775	45.09	1.215	30.86	1.051	26.70	.296	7.52	.351	8.92	.195	4.95	.333	8.46	2.000	50.80	2.270	57.64	.155	3.94
100P	2.585	65.66	1.800	45.72	1.383	35.13	.270	6.86	.394	10.01	.183	4.65	.525	13.34	2.800	71.12	3.250	82.55	.293	7.44
100S	2.585	65.66	1.800	45.72	1.451	36.86	.333	8.46	.394	10.01	.195	4.95	.525	13.34	2.800	71.12	3.250	82.55	.293	7.44

# MIL-DTL-83513/22 Thru /27 Micro-D Connectors Straight PCB Connectors (BS)



Micro-D  
MIL-DTL-83513

## M83513/22 THRU /24 PCB LAYOUTS – PIN CONNECTORS

Patterns shown are for connector mounting side of PC board. 9 Thru 51 Contacts .096 (2.44) Diameter Mounting Holes, 100 Pin .125 (3.18) Diameter

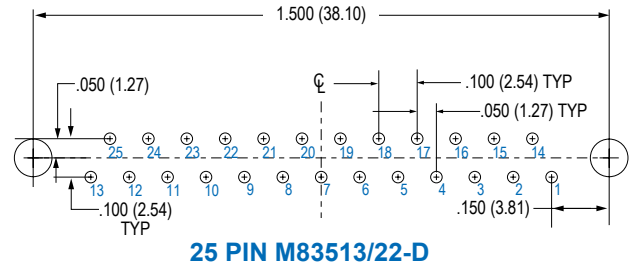
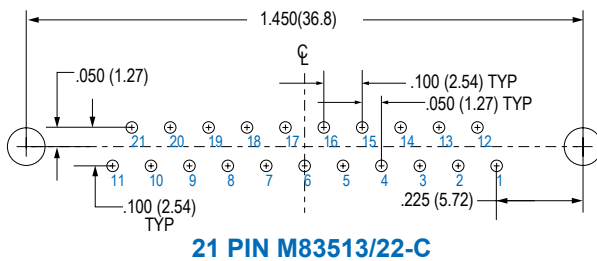
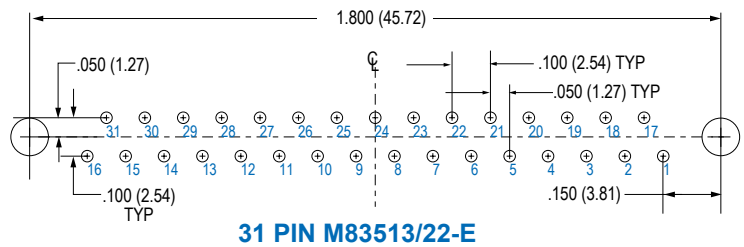
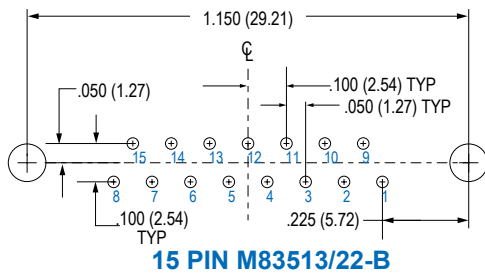
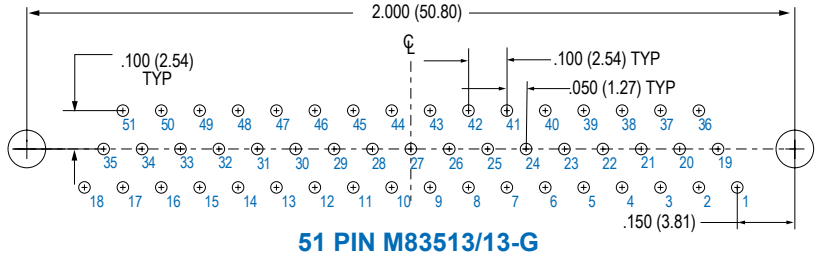
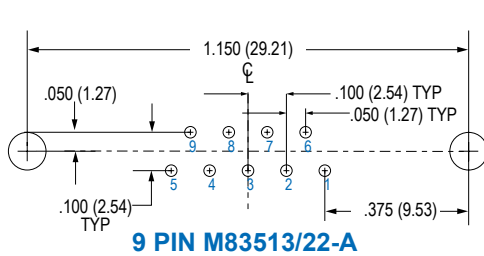

### Connector Orientation

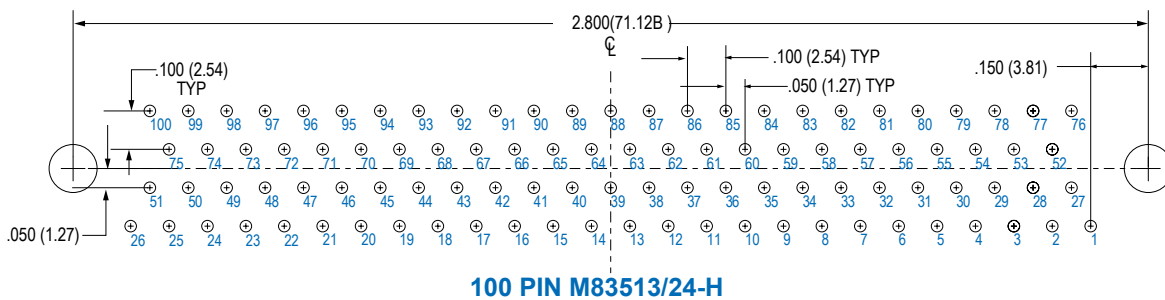
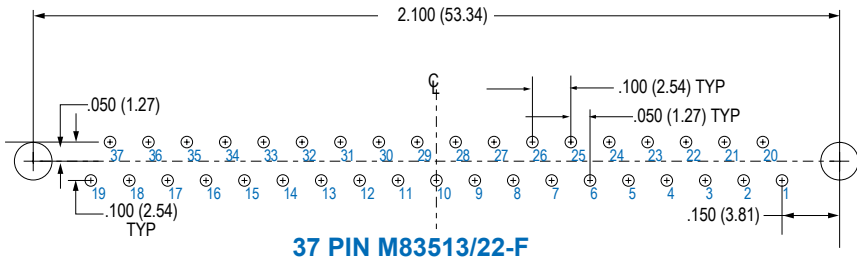
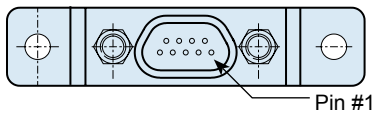



# MIL-DTL-83513/22 Thru /27 Micro-D Connectors Straight PCB Connectors (BS)

## M83513/25 THRU /27 PCB LAYOUTS – SOCKET CONNECTORS

Patterns shown are for connector mounting side of PC board. 9 Thru 51 Contacts .096 (2.44) Diameter Mounting Holes, 100 Pin .125 (3.18) Diameter

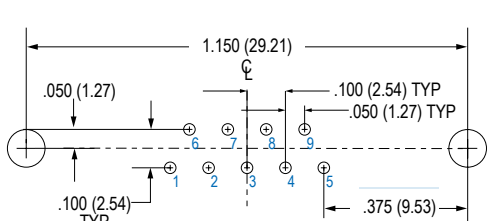

**9 SOCKET M83513/25-A**

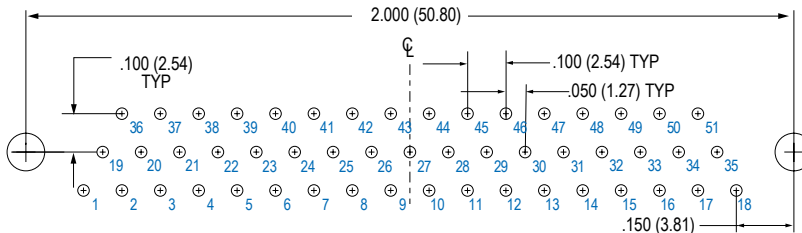

**51 SOCKET M83513/26-G**

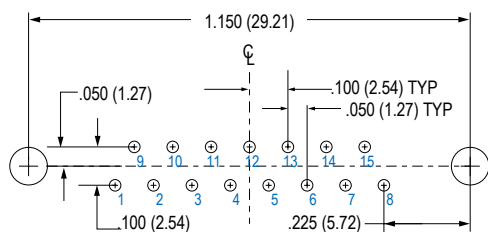

**15 SOCKET M83513/25-B**

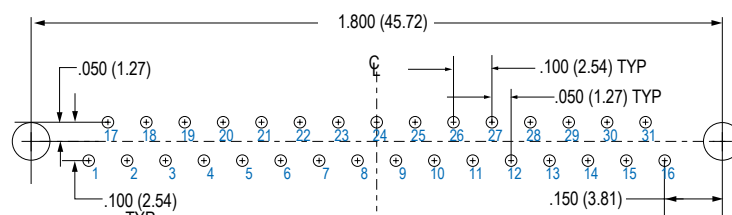

**31 SOCKET M83513/25-E**

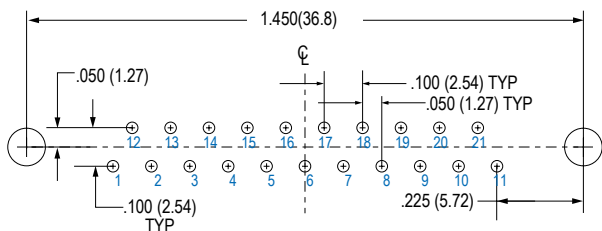

**21 SOCKET M83513/25-C**

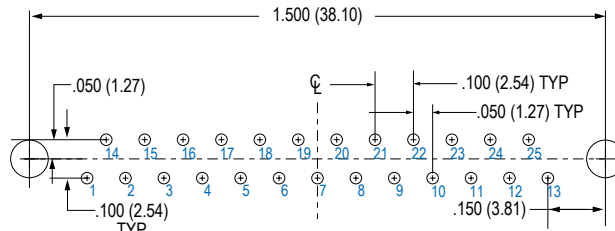

**25 SOCKET M83513/25-D**

**Connector Orientation**

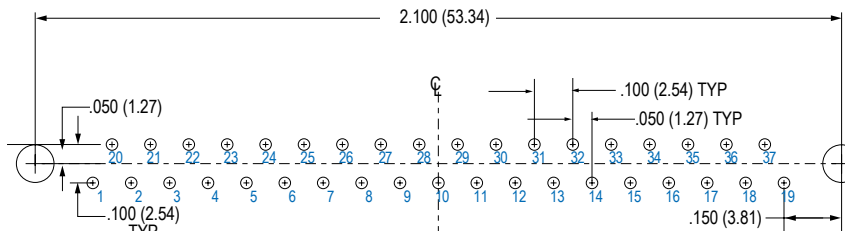
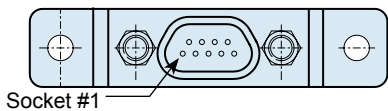

**37 SOCKET M83513/25-F**

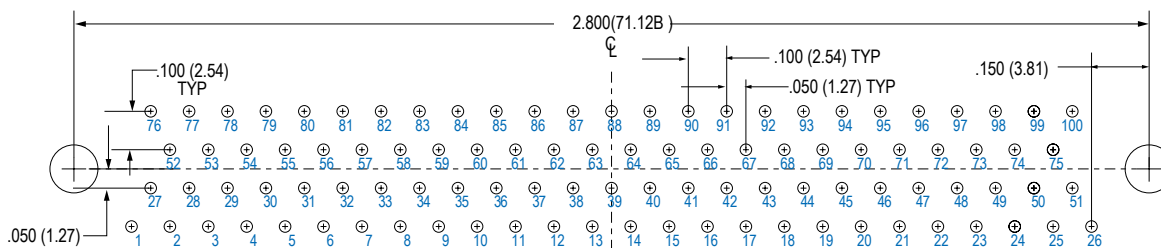

**100 SOCKET M83513/27-H**