

PRODUCT NUMBER
SEE TABLE

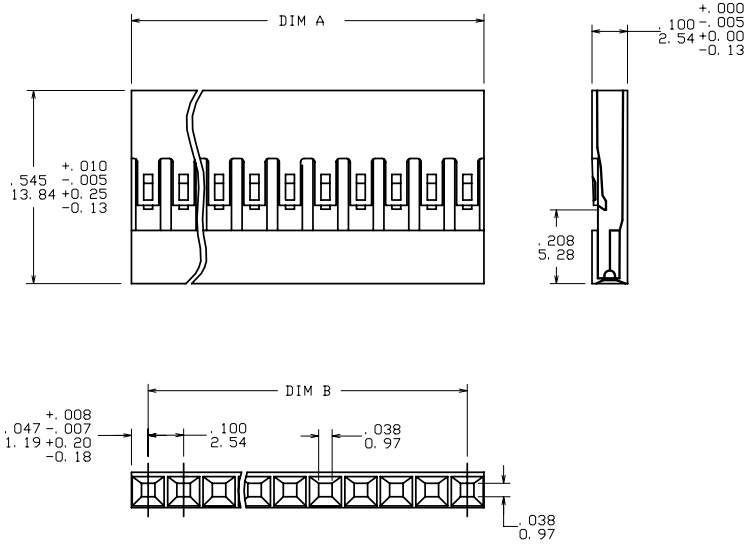

CONFIGURATION 1
(WITHOUT RIB)

NOTES:

- MOLDING MATERIAL: MODIFIED POLYPHENYLENE ETHER, COLOR: BLACK, UL 94V-0.
- PIN LENGTH TO BE .210/5.33 MIN RECOMMENDED PIN LENGTH IS .225/5.72 ± .015/0.38.
- FOR TERMINAL APPLICATION SEE TA-531. PRODUCT SPECIFICATION: BUS-12-067.
- TERMINALS MUST BE CRIMPED PROPERLY FOR SATISFACTORY LATCHING. SEE TA-75 FOR CRIMPING INSTRUCTIONS.
- THIS HOUSING IS INTENDED FOR USE WITH MINI PV^M TERMINAL WITH 22-36 GAUGE WIRE.
- ALL MARKING EXCEPT LOGO DONE IN "6 POINT TYPE SET" IF SPACE PERMITS APPROX AREA PER NUMBER/LETTER .056/1.42 WIDE X .06/1.5 HIGH USING WHITE PERMANENT INK.
- ALL MARKINGS FOR MILITARY PART NUMBERS ARE TO BE PER MIL-STD-1285. SEE TABULATION.
- PLACE DESC P/N AND CAGE NO. ON PACKAGING LABEL. PRODUCT LENGTH IS TOO SMALL TO MARK PART.
- THESE PARTS ARE AS MOLDED WITH NO MARKINGS AND NO RESTRICTIONS, (BUT ARE MARKETABLE).
- PRODUCT MEETS EUROPEAN UNION DIRECTIVES AND OTHER COUNTRY REGULATIONS AS DESCRIBED IN GS-22-008.
- THE PRODUCT IS NOT INTENDED TO BE EXPOSED TO MANUFACTURING SOLDER PROCESS.
- EUROPEAN CUSTOMERS SHOULD ORDER PART NUMBERS WITH AN 'E' SUFFIX AS SHOWN IN TABLE TO CONTINUE TO BE SUPPLIED BY THE EUROPEAN PLANT. SEE DRAWING 65039EUR.

mat'l code	surface	tolerance	projection	product family
SEE NOTE 1	ASME Y14.5 ✓	ASME Y14.5		PV HOUSINGS
tr ecn no dr date	tolerances unless otherwise specified		INCH/MM	title
BE v07-0483 HTB 2007-07-24	angles	XX+01/XX-3		MINI LATCH HOUSING
		XXX+005/XXX-13	scale 3:1	SINGLE ROW .100 [2.54] CC
AY v03-1356 PJ 2004-01-31	0°±2'	XXXX+0020/XXX+051		dwg no 65039 sheet 1 of 12 size A4
BA v05-0712 DAI 2005-07-27	dr			type Product Customer Drawing
BB v06-0407 HTB 2006-04-26	engi			
BC v06-0549 HTB 2006-06-12	chr			
BD v06-0886 HTB 2006-08-31	apdd			
sheet	revision	BE BE BE BE BE BE BE BE	BE BE BE BE BE BE BE BE	
index	sheet	1 2 3 4 5 6 7 8 9 10 11 12		



1 | 2

3

4

PRODUCT NUMBER
SEE TABLE

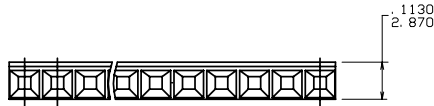
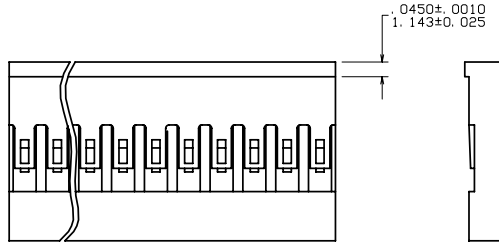

CONFIGURATION 2
(WITH RIB)

mat'l. code		surface		tolerance		projection		product family	
SEE NOTE 1		ASME Y14.5 ✓		ASME Y14.5				PV HOUSINGS	
ltr	ec'n no	dr	date	tolerances unless otherwise specified		INCH/MM		title	
BE				angles	XXX+01/XX+3			MINI LATCH HOUSING	
				0°±2'	XXX+005/XXX+13	scale 3:1		SINGLE ROW .100 [2.54] CC	
				dr	M. CORNMAN 1990-01-31			dwg no	
				engr	H. SUNDY 1990-01-31			sheet 2 of 12	
				chr	H. SUNDY 1990-01-31			65039	
				appd	H. SUNDY 1990-01-31			type	
sheet	revision							Product Customer Drawing	
index	sheet								

form A4mmXLC

1

2

3

4

<p>PRODUCT NO SEE TABLE</p> <p>MARK CO. LOGO TRADEMARK & PART NO. & CAVITY NO. APPROX. AS SHOWN.</p> <p>STYLE A</p>	<p>MARK CUST NAME AND CAVITY NO. APPROX AS SHOWN.</p> <p>STYLE D</p>	<p>CO. LOGO, CUSTOMER PART NO. LOGO, CUSTOMER PART NO. FIRST AND LAST CAVITIES AND EVERY FIFTH CAVITY MARKED PERMANENTLY AND LEGIBLE IN WHITE INK APPROX AS SHOWN.</p> <p>STYLE G</p>	<p>STYLE K</p>
<p>MARK CO. LOGO TRADEMARK & PART NO. & CAVITY NO. APPROX. AS SHOWN.</p> <p>STYLE B</p>	<p>MARK NUMBERS AS SHOWN CHARACTERS TO BE PERMANENT AND LEGIBLE AFTER REACHING #9 CAVITY CONTINUE ONLY MARKING EVERY OTHER ONE; IE. #11,#13, #15 ETC.</p> <p>STYLE E</p>	<p>MARK CHARACTERS AS SHOWN (ONE SIDE ONLY) 1,5,10,15, 20,ETC.</p> <p>STYLE H</p>	<p>MARK CHARACTERS AS SHOWN IN WHITE (ONE SIDE ONLY)</p> <p>STYLE L</p>
<p>MARK LETTERS AS SHOWN CHARACTERS TO BE PERMANENT & LEGIBLE. OMIT (I) POS AS SHOWN</p> <p>STYLE C</p>	<p>MARK ARROW IN WHITE APPROX AS SHOWN.</p> <p>STYLE F</p>	<p>NOTE 6</p> <p>STYLE J</p>	



mat'l. code	SEE NOTE 1	surface	tolerance	projection	product family
BE	ecm no	ASME Y14.5	ASME Y14.5		PV HOUSINGS
	dr	tolerances unless otherwise specified		INCH/MM	title
	date	angles	XX+01/XX+3	scale 1:1	MINI LATCH HOUSING
		flatness	XXX+005/XXX+13		SINGLE ROW .100 [2.54] CC
		0°±2'	XXXX+0020/XXX+051		dwg no
		dr			65039
		enrg	M. CORNMAN 1990-01-31		sheet 3 of 12
		chr	H. SUNDY 1990-01-31		size
		appd	H. SUNDY 1990-01-31		A4
sheet	revision				type
index	sheet				Product Customer Drawing



1 | 2

3

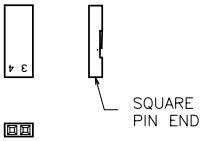
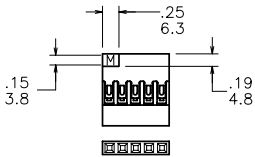
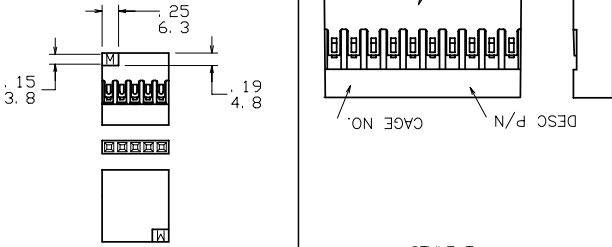
4

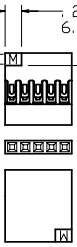
PRODUCT NO SEE TABLE	MARK CHARACTERS ON SIDE OPPOSITE THE LATCHES ON THE PLUGGABLE SQUARE PIN END	MARK AN M (BLACK) IN THE CORNER AS SHOWN, WITH A WHITE BACKGROUND.	
 <p>STYLE M</p>	 <p>SQUARE PIN END</p> <p>STYLE P</p>	 <p>STYLE S</p>	
CAVITY MARKED WITH ARROW	MARK AN M (BLACK) IN THE CORNER AS SHOWN, ON BOTH SIDES OF THE PART.	 <p>DATE CODE</p> <p>DESC P/N</p> <p>CAGE NO.</p> <p>STYLE T NOTE-7 & 8</p>	
 <p>STYLE N</p>	 <p>STYLE R</p>		

mat'l. code	SEE NOTE 1	surface	tolerance	projection	product family
lfr	ecrn no	dr	date	INCH/MM	PV HOUSINGS
BE				scale 1:1	title
					MINI LATCH HOUSING
					SINGLE ROW .100 [2.54] CC
					dwg no
					65039
					sheet 4 of 12
					size A4
					type
					Product Customer Drawing
sheet index	revision sheet				

form: A4mmXLC 1 | 2 | 3 | 4

Copyright FCJ



FCJconnect.com

PRODUCT NO.	NO.OF POS.	DIM A MAX	DIM B	EUROPEAN VERSION-NOTE 12	CONFIGURATION
65039-001LF	36	3.600/91.44	3.500/88.90	65039-001ELF	1
65039-002LF	35	3.500/88.90	3.400/86.36	65039-002ELF	1
65039-003LF	34	3.400/86.36	3.300/83.82	65039-003ELF	1
65039-004LF	33	3.300/83.82	3.200/81.28	65039-004ELF	1
65039-005LF	32	3.200/81.28	3.100/78.74	65039-005ELF	1
65039-006LF	31	3.100/78.74	3.000/76.20	65039-006ELF	1
65039-007LF	30	3.000/76.20	2.900/73.66	65039-007ELF	1
65039-008LF	29	2.900/73.66	2.800/71.12	65039-008ELF	1
65039-009LF	28	2.800/71.12	2.700/68.58	65039-009ELF	1
65039-010LF	27	2.700/68.58	2.600/66.04	65039-010ELF	1
65039-011LF	26	2.600/66.04	2.500/63.50	65039-011ELF	1
65039-012LF	25	2.500/63.50	2.400/60.96	65039-012ELF	1
65039-013LF	24	2.400/60.96	2.300/58.24	65039-013ELF	1
65039-014LF	23	2.300/58.24	2.200/55.88	65039-014ELF	1
65039-015LF	22	2.200/55.88	2.100/53.34	65039-015ELF	1
65039-016LF	21	2.100/53.34	2.000/50.80	65039-016ELF	1
65039-017LF	20	2.000/50.80	1.900/48.26	65039-017ELF	1
65039-018LF	19	1.900/48.26	1.800/45.72	65039-018ELF	1
65039-019LF	18	1.800/45.72	1.700/43.18	65039-019ELF	1
65039-020LF	17	1.700/43.18	1.600/40.64	65039-020ELF	1
65039-021LF	16	1.600/40.64	1.500/38.10	65039-021ELF	1
65039-022LF	15	1.500/38.10	1.400/35.56	65039-022ELF	1
65039-023LF	14	1.400/35.56	1.300/33.02	65039-023ELF	1
65039-024LF	13	1.300/33.02	1.200/30.48	65039-024ELF	1
65039-025LF	12	1.200/30.48	1.100/27.94	65039-025ELF	1
65039-026LF	11	1.100/27.94	1.000/25.40	65039-026ELF	1
65039-027LF	10	1.000/25.40	.900/22.86	65039-027ELF	1
65039-028LF	9	.900/22.86	.800/20.32	65039-028ELF	1
65039-029LF	8	.800/20.32	.700/17.78	65039-029ELF	1
65039-030LF	7	.700/17.78	.600/15.24	65039-030ELF	1
65039-031LF	6	.600/15.24	.500/12.70	65039-031ELF	1
65039-032LF	5	.500/12.70	.400/10.16	65039-032ELF	1
65039-033LF	4	.400/10.16	.300/7.62	65039-033ELF	1
65039-034LF	3	.300/7.62	.200/5.08	65039-034ELF	1
65039-035LF	2	.200/5.08	.100/2.54	65039-035ELF	1
65039-036LF	1	.100/2.54	—	—	1

mat'l. code	SEE NOTE 1	surface	tolerance	projection	product family
lfr	ecrn no	ASME Y14.5 ✓	ASME Y14.5		PV HOUSINGS
BE		tolerances unless otherwise specified	XX±01/XX±3	INCH/MM	title
		angles	XXX±005/XXX±13	scale 3:1	MINI LATCH HOUSING
		0°±2'	XXXX±0020/XXX±051		SINGLE ROW .100 [2.54] CC
		dr	M. CORNMAN 1990-01-31		dwg no
		engr	H. SUNDY 1990-01-31		65039
		chr	H. SUNDY 1990-01-31		sheet 5 of 12
		appd	H. SUNDY 1990-01-31		A4
sheet index	revision sheet				type Product Customer Drawing

form A4mmXLC

Copyright FCI



FCIconnect.com

1 | 2

3

4

MILITARY PRODUCT NO.	MADE FROM	MARKING STYLE	DESC P/N	CAGE NO.	REMARKS
65039-001-MIL	65039-001	T	86060-36	22526	OBSOLETE
65039-002-MIL	65039-002	T	86060-35	22526	OBSOLETE
65039-003-MIL	65039-003	T	86060-34	22526	OBSOLETE
65039-004-MIL	65039-004	T	86060-33	22526	OBSOLETE
65039-005-MIL	65039-005	T	86060-32	22526	OBSOLETE
65039-006-MIL	65039-006	T	86060-31	22526	OBSOLETE
65039-007-MIL	65039-007	T	86060-30	22526	OBSOLETE
65039-008-MIL	65039-008	T	86060-29	22526	OBSOLETE
65039-009-MIL	65039-009	T	86060-28	22526	OBSOLETE
65039-010-MIL	65039-010	T	86060-27	22526	OBSOLETE
65039-011-MIL	65039-011	T	86060-26	22526	OBSOLETE
65039-012-MIL	65039-012	T	86060-25	22526	OBSOLETE
65039-013-MIL	65039-013	T	86060-24	22526	OBSOLETE
65039-014-MIL	65039-014	T	86060-23	22526	OBSOLETE
65039-015-MIL	65039-015	T	86060-22	22526	OBSOLETE
65039-016-MIL	65039-016	T	86060-21	22526	OBSOLETE
65039-017-MIL	65039-017	T	86060-20	22526	OBSOLETE
65039-018-MIL	65039-018	T	86060-19	22526	OBSOLETE
65039-019-MIL	65039-019	T	86060-18	22526	OBSOLETE
65039-020-MIL	65039-020	T	86060-17	22526	OBSOLETE
65039-021-MIL	65039-021	T	86060-16	22526	OBSOLETE
65039-022-MIL	65039-022	T	86060-15	22526	OBSOLETE
65039-023-MIL	65039-023	T	86060-14	22526	OBSOLETE
65039-024-MIL	65039-024	T	86060-13	22526	OBSOLETE
65039-025-MIL	65039-025	T	86060-12	22526	OBSOLETE
65039-026-MIL	65039-026	T	86060-11	22526	OBSOLETE
65039-027-MIL	65039-027	T	86060-10	22526	OBSOLETE
65039-028-MIL	65039-028	T	86060-09	22526	SEE NOTE 8 OBSOLETE
65039-029-MIL	65039-029	T	86060-08	22526	SEE NOTE 8 OBSOLETE
65039-030-MIL	65039-030	T	86060-07	22526	SEE NOTE 8 OBSOLETE
65039-031-MIL	65039-031	T	86060-06	22526	SEE NOTE 8 OBSOLETE
65039-032-MIL	65039-032	T	86060-05	22526	SEE NOTE 8 OBSOLETE
65039-033-MIL	65039-033	T	86060-04	22526	SEE NOTE 8 OBSOLETE
65039-034-MIL	65039-034	T	86060-03	22526	SEE NOTE 8 OBSOLETE
65039-035-MIL	65039-035	T	86060-02	22526	SEE NOTE 8 OBSOLETE
65039-036-MIL	65039-036	T	86060-01	22526	SEE NOTE 8 OBSOLETE

mat'l code		surface		tolerance		projection		product family	
SEE NOTE 1		ASME Y14.5 ✓		ASME Y14.5				PV HOUSINGS	
ltr	ecrn no	dr	date	tolerances unless otherwise specified					
BE				angles	XXX+01/XX-3		INCH/MM		title
					XXX+005/XXX+13		scale 1:1		MINI LATCH HOUSING
				0'±2'	XXXX+0020/XXX+051				SINGLE ROW .100 [2.54] CC
		dr	M. CORNMAN	1990-01-31	dwg no				
		engr	H. SUNDY	1990-01-31	sheet 6 of 12 size				
		chr	H. SUNDY	1990-01-31	65039 A4				
		appd	H. SUNDY	1990-01-31	type Product Customer Drawing				
sheet index	revision sheet								

form A4mmXc

1 | 2

3

4

Copyright FCJ



FCJconnect.com

1 | 2

3 |

4

PRODUCT NO	NO. OF POS.	DIM A MAX	DIM B	SPECIAL MARKINGS	CUSTOMER RESTRICTED	CONFIGURATION
65039-037LF	8	.800/20.32	.700/17.78	STYLE A		1
65039-038LF	8	.800/20.32	.700/17.78	B		↑
65039-039LF	10	1.000/25.40	.900/22.86	C		
65039-040LF	5	.500/12.70	.400/10.16	C		
65039-041LF	8	.800/20.32	.700/17.78	D	X	
65039-042LF	8	.800/20.32	.700/17.78	E		
65039-043LF	6	.600/15.24	.500/12.70	E		
65039-044LF	10	1.000/25.40	.900/22.86	A		
65039-045LF	4	.400/10.16	.300/7.62	A		
65039-046LF	9	.900/22.86	.800/20.32	A		
65039-047LF	7	.700/17.78	.600/15.24	A		
65039-048LF	20	2.000/50.80	1.900/48.26	A		
65039-049LF	3	.300/7.62	.200/5.08	C		
65039-050LF	8	.800/20.32	.700/17.78	F		
65039-051LF	16	1.600/40.64	1.500/38.10	F		
65039-052LF	20	2.000/50.80	1.900/48.26	F		
65039-053LF	24	2.400/60.96	2.300/58.24	F		
65039-054LF	19	1.900/48.26	1.800/45.72	E		
65039-055LF	33	3.300/83.82	3.200/81.28	E		
65039-056LF	7	.700/17.78	.600/15.24	E		
65039-057LF	4	.400/10.16	.300/7.62	F		
65039-058LF	12	1.200/30.48	1.100/27.94	F		
65039-059LF	14	1.400/35.56	1.300/33.02	F		
65039-060LF	6	.600/15.24	.500/12.70	A		
65039-061LF	2	.200/5.08	.100/2.54	A		
65039-062LF	2	.200/5.08	.100/2.54	F		
65039-063LF	10	1.000/25.40	.900/22.86	F		
65039-064LF	8	.800/20.32	.700/17.78	G	X	
65039-065LF	13	1.300/33.02	1.200/30.48	A		
65039-066LF	11	1.100/27.94	1.000/25.40	A		
65039-067LF	14	1.400/35.56	1.300/33.02	A		
65039-068LF	21	2.100/53.34	2.000/50.80	A		
65039-069LF	2	.200/5.08	.100/2.54	C		
65039-070LF	8	.800/20.32	.700/17.78	C		
65039-071LF	17	1.700/43.18	1.600/40.64	A		↓
65039-072LF	7	.700/17.78	.600/15.24	STYLE H		1

mat'l. code	SEE NOTE 1	surface	tolerance	projection	product family
lfr	ecn no	dr	date	ASME Y14.5 ✓	ASME Y14.5
BE				tolerances unless otherwise specified	product family
				angles	PV HOUSINGS
				0°±2'	title
				dr M. CORNMAN 1990-01-31	MINI LATCH HOUSING
				enrgt H. SUNDY 1990-01-31	SINGLE ROW .100 [2.54] CC
				chr H. SUNDY 1990-01-31	dwg no
				appd H. SUNDY 1990-01-31	sheet 7 of 12
sheet index	revision sheet				65039
					A4
					type Product Customer Drawing

form A4mmXc

1 |

2 |

3 |

4

PDM: Rev:BE STATUS: Released Printed: May 01, 2009

Copyright FCJ



FCJconnect.com

1 | 2

3 |

4

PRODUCT NO	NO.OF POS.	DIM A MAX	DIM B	SPECIAL MARKINGS	CUSTOMER RESTRICTED	CONFIGURATION
65039-073LF	32	3.200/81.28	3.100/78.74	STYLE A	X	1
65039-074LF	3	.300/7.62	.200/5.08	A		
65039-075LF	16	1.600/40.64	1.500/38.10	E		
65039-076LF	25	2.500/63.50	2.400/60.96	E		
65039-077LF	5	.500/12.70	.400/10.16	J	X	
65039-078LF	24	2.400/60.96	2.300/58.24	A		
65039-079LF	27	2.700/68.58	2.600/66.04	A		
65039-080LF	33	3.300/83.82	3.200/81.28	A		
65039-081LF	29	2.900/73.66	2.800/71.12	A		
65039-082LF	5	.500/12.70	.400/10.16	A		
65039-083LF	7	.700/17.78	.600/15.24	K		
65039-084LF	3	.300/7.62	.200/5.08	E	X	
65039-085LF	9	.900/22.86	.800/20.32	E	X	
65039-086LF	11	1.100/27.94	1.000/25.40	E	X	
65039-087LF	25	2.500/63.50	2.400/60.96	A		
65039-088LF	15	1.500/38.10	1.400/35.56	A		
65039-089LF	4	.400/10.16	.300/7.62	C		
65039-090LF	12	1.200/30.48	1.100/27.94	A		
65039-091LF	4	.400/10.16	.300/7.62	L		
65039-092LF	16	1.600/40.64	1.500/38.10	A		
65039-093LF	18	1.800/45.72	1.700/43.18	A		
65039-094LF	19	1.900/48.26	1.800/45.72	A		
65039-095LF	22	2.200/55.88	2.100/53.34	A		
65039-096LF	23	2.300/58.42	2.200/55.88	A		
65039-097LF	26	2.600/66.04	2.500/63.50	A		
65039-098LF	28	2.800/71.12	2.700/68.58	A		
65039-099LF	30	3.000/76.20	2.900/73.66	A		
65039-100LF	31	3.100/78.74	3.000/76.20	A		
65039-101LF	34	3.400/86.36	3.300/83.82	A		
65039-102LF	35	3.500/88.90	3.400/86.36	A		
65039-103LF	36	3.600/91.44	3.500/88.90	A		
65039-104LF	2	.200/5.08	.100/2.54	E		
65039-105LF	2	.200/5.08	.100/2.54	M		
65039-106LF	3	.300/7.62	.200/5.08	N		
65039-107LF	5	.500/12.70	.400/10.16	N		
65039-108LF	9	.900/22.86	.800/20.32	STYLE F		1

mat'l. code	SEE NOTE 1	surface	tolerance	projection	product family
l/r	ec'n no	dr	date	ASME Y14.5 ✓ ASME Y14.5	PV HOUSINGS
BE				tolerances unless otherwise specified	title
				angles	MINI LATCH HOUSING
				finishes	SINGLE ROW .100 [2.54] CC
				0°±2'	INCH/MM
				XXXX+0020/XXX+051	scale 1:1
		dr	M. CORNMANN	1990-01-31	FCJ
		engr	H. SUNDY	1990-01-31	dwg no
		chr	H. SUNDY	1990-01-31	65039
		appd	H. SUNDY	1990-01-31	sheet 8 of 12
sheet index	revision sheet				size A4
					type Product Customer Drawing

form A4mmXLC

1 |

2 |

3 |

4

PDM: Rev:BE STATUS: Released Printed: May 01, 2009



1 | 2

3 |

4

PRODUCT NO	NO. OF POS.	DIM A MAX	DIM B	SPECIAL MARKINGS	CUSTOMER RESTRICTED	CONFIGURATION
65039-109LF	2	.200/5.08	.100/2.54	STYLE P		1
65039-110LF	5	.500/12.7	.400/10.16	STYLE R		1
65039-111LF	5	.500/12.7	.400/10.16	STYLE S		1

mat'l. code	SEE NOTE 1	surface	tolerance	projection	product family
lfr	ecrn no	dr	date	ASME Y14.5	ASME Y14.5
BE				INCH/MM	PV HOUSINGS
		angles	tolerances unless otherwise specified	scale 1:1	title
		0°±2'	XXX+01/XX+3		MINI LATCH HOUSING
			XXX+005/XXX+3		SINGLE ROW .100 [2.54] CC
			XXXX+0020/XXX+051		dwg no
		dr	M. CORNMAN	1990-01-31	sheet 9 of 12
		engr	H. SUNDY	1990-01-31	size
		chr	H. SUNDY	1990-01-31	A4
		appd	H. SUNDY	1990-01-31	type
sheet index	revision sheet				Product Customer Drawing

form: A4mmXLC 1 | 2 | 3 | 4

PDM: Rev:BE STATUS: Released Printed: May 01, 2009

Copyright FCJ



FCJconnect.com

PRODUCT NO	NO. OF POS.	DIM A MAX	DIM B	SPECIAL MARKINGS	CUSTOMER RESTRICTED	CONFIGURATION
65039-201LF	36	3.600/91.44	3.500/88.90	NOTE 9	NOTE 9	2
65039-202LF	35	3.500/88.90	3.400/86.36			
65039-203LF	34	3.400/86.36	3.300/83.82			
65039-204LF	33	3.300/83.82	3.200/81.28			
65039-205LF	32	3.200/81.28	3.100/78.74			
65039-206LF	31	3.100/78.74	3.000/76.20			
65039-207LF	30	3.000/76.20	2.900/73.66			
65039-208LF	29	2.900/73.66	2.800/71.12			
65039-209LF	28	2.800/71.12	2.700/68.58			
65039-210LF	27	2.700/68.58	2.600/66.04			
65039-211LF	26	2.600/66.04	2.500/63.50			
65039-212LF	25	2.500/63.50	2.400/60.96			
65039-213LF	24	2.400/60.96	2.300/58.24			
65039-214LF	23	2.300/58.24	2.200/55.88			
65039-215LF	22	2.200/55.88	2.100/53.34			
65039-216LF	21	2.100/53.34	2.000/50.80			
65039-217LF	20	2.000/50.80	1.900/48.26			
65039-218LF	19	1.900/48.26	1.800/45.72			
65039-219LF	18	1.800/45.72	1.700/43.18			
65039-220LF	17	1.700/43.18	1.600/40.64			
65039-221LF	16	1.600/40.64	1.500/38.10			
65039-222LF	15	1.500/38.10	1.400/35.56			
65039-223LF	14	1.400/35.56	1.300/33.02			
65039-224LF	13	1.300/33.02	1.200/30.48			
65039-225LF	12	1.200/30.48	1.100/27.94			
65039-226LF	11	1.100/27.94	1.000/25.40			
65039-227LF	10	1.000/25.40	.900/22.86			
65039-228LF	9	.900/22.86	.800/20.32			
65039-229LF	8	.800/20.32	.700/17.78			
65039-230LF	7	.700/17.78	.600/15.24			
65039-231LF	6	.600/15.24	.500/12.70			
65039-232LF	5	.500/12.70	.400/10.16			
65039-233LF	4	.400/10.16	.300/7.62			
65039-234LF	3	.300/7.62	.200/5.08			
65039-235LF	2	.200/5.08	.100/2.54			
65039-236LF	1	.100/2.54		NOTE 9	NOTE 9	2

mat'l code	SEE NOTE 1	surface	tolerance	projection	product family
BE	ecm no	ASME Y14.5 ✓	ASME Y14.5		PV HOUSINGS
dr	date	tolerances unless otherwise specified		INCH/MM	title
		angles	XXX+01/XX+3	scale 1:1	MINI LATCH HOUSING
		flatness	XXX+005/XXX+13		SINGLE ROW .100 [2.54] CC
		0°±2'	XXXX+0020/XXX+051		dwg no
		dr	M. CORNMAN 1990-01-31		sheet 10 of 12
		engr	H. SUNDY 1990-01-31		65039
		chr	H. SUNDY 1990-01-31		A4
		appd	H. SUNDY 1990-01-31		type
sheet index	revision sheet				Product Customer Drawing

form A4mmX4c

Copyright FCJ



FCJconnect.com

1 | 2

3 |

4

PRODUCT NO	NO. OF POS.	DIM A MAX	DIM B	SPECIAL MARKINGS	CUSTOMER RESTRICTED	CONFIGURATION
65039-237LF	8	.800/20.32	.700/17.78	A		2
65039-238LF	8	.800/20.32	.700/17.78	B		
65039-239LF	10	1.000/25.40	.900/22.86	C		
65039-240LF	5	.500/12.70	.400/10.16	C		
65039-241LF	8	.800/20.32	.700/17.78	D		
65039-242LF	8	.800/20.32	.700/17.78	E		
65039-243LF	6	.600/15.24	.500/12.70	E		
65039-244LF	10	1.000/25.40	.900/22.86	A		
65039-245LF	4	.400/10.16	.300/7.62	A		
65039-246LF	9	.900/22.86	.800/20.32	A		
65039-247LF	7	.700/17.78	.600/15.24	A		
65039-248LF	20	2.000/50.80	1.900/48.26	A		
65039-249LF	3	.300/7.62	.200/5.08	C		
65039-250LF	8	.800/20.32	.700/17.78	F		
65039-251LF	16	1.600/40.64	1.500/38.10	F		
65039-252LF	20	2.000/50.80	1.900/48.26	F		
65039-253LF	24	2.400/60.96	2.300/58.24	F		
65039-254LF	19	1.900/48.26	1.800/45.72	E		
65039-255LF	33	3.300/83.82	3.200/81.28	E		
65039-256LF	7	.700/17.78	.600/15.24	E		
65039-257LF	4	.400/10.16	.300/7.62	F		
65039-258LF	12	1.200/30.48	1.100/27.94	F		
65039-259LF	14	1.400/35.56	1.300/33.02	F		
65039-260LF	6	.600/15.24	.500/12.70	A		
65039-261LF	2	.200/5.08	.100/2.54	A		
65039-262LF	2	.200/5.08	.100/2.54	F		
65039-263LF	10	1.000/25.40	.900/22.86	F		
65039-264LF	8	.800/20.32	.700/17.78	G		
65039-265LF	13	1.300/33.02	1.200/30.48	A		
65039-266LF	11	1.100/27.94	1.000/25.40	A		
65039-267LF	14	1.400/35.56	1.300/33.02	A		
65039-268LF	21	2.100/53.34	2.000/50.80	A		
65039-269LF	2	.200/5.08	.100/2.54	C		
65039-270LF	8	.800/20.32	.700/17.78	C		
65039-271LF	17	1.700/43.18	1.600/40.64	A		
65039-272LF	7	.700/17.78	.600/15.24	H		
65039-273LF	32	3.200/81.28	3.100/78.74	A		
65039-274LF	3	.300/7.62	.200/5.08	A		
65039-275LF	16	1.600/40.64	1.500/38.10	E		
65039-276LF	25	2.500/63.50	2.400/60.96	E		
65039-277LF	5	.500/12.70	.400/10.16	J		2

mat'l. code	SEE NOTE 1	surface	tolerance	projection	product family
lfr	ecrn no	ASME Y14.5 ✓	ASME Y14.5		PV HOUSINGS
BE	dr	tolerances unless otherwise specified	angles	INCH/MM	title
	date		0°±2'	scale 1:1	MINI LATCH HOUSING
			dr M. CORNMAN 1990-01-31		SINGLE ROW .100 [2.54] CC
			enrgt H. SUNDY 1990-01-31		dwg no 65039 sheet 11 of 12 size A4
			chr H. SUNDY 1990-01-31		type Product Customer Drawing
			appd H. SUNDY 1990-01-31		
sheet index	revision sheet				

form A4mmXLC

1 |

2 |

3 |

4

PDM: Rev:BE STATUS: Released Printed: May 01, 2009

Copyright FCJ



FCJconnect.com

1 | 2

3 |

4

PRODUCT NO	NO. OF POS.	DIM A MAX	DIM B	SPECIAL MARKINGS	CUSTOMER RESTRICTED	CONFIGURATION
65039-278LF	24	2.400/60.96	2.300/58.24	A		2
65039-279LF	27	2.700/68.58	2.600/66.04	A		
65039-280LF	33	3.300/83.82	3.200/81.28	A		
65039-281LF	29	2.900/73.66	2.800/71.12	A		
65039-282LF	5	.500/12.70	.400/10.16	A		
65039-283LF	7	.700/17.78	.600/15.24	K		
65039-284LF	3	.300/7.62	.200/5.08	E		
65039-285LF	9	.900/22.86	.800/20.32	E		
65039-286LF	11	1.100/27.94	1.000/25.40	E		
65039-287LF	25	2.500/63.50	2.400/60.96	A		
65039-288LF	15	1.500/38.10	1.400/35.56	A		
65039-289LF	4	.400/10.16	.300/7.62	C		
65039-290LF	12	1.200/30.48	1.100/27.94	A		
65039-291LF	4	.400/10.16	.300/7.62	L		
65039-292LF	16	1.600/40.64	1.500/38.10	A		
65039-293LF	18	1.800/45.72	1.700/43.18	A		
65039-294LF	19	1.900/48.26	1.800/45.72	A		
65039-295LF	22	2.200/55.88	2.100/53.34	A		
65039-296LF	23	2.300/58.24	2.200/55.88	A		
65039-297LF	26	2.600/66.04	2.500/63.50	A		
65039-298LF	28	2.800/71.12	2.700/68.58	A		
65039-299LF	30	3.000/76.20	2.900/73.66	A		
65039-300LF	31	3.100/78.74	3.000/76.20	A		
65039-301LF	34	3.400/86.36	3.300/83.82	A		
65039-302LF	35	3.500/88.90	3.400/86.36	A		
65039-303LF	36	3.600/91.44	3.500/88.90	A		
65039-304LF	2	.200/5.08	.100/2.54	E		
65039-305LF	2	.200/5.08	.100/2.54	M		
65039-306LF	3	.300/7.62	.200/5.08	N		
65039-307LF	5	.500/12.70	.400/10.16	N		
65039-308LF	9	.900/22.86	.800/20.32	F		2

mat'l. code	SEE NOTE 1	surface	tolerance	projection	product family
lfr	ecrn no	ASME Y14.5 ✓	ASME Y14.5		PV HOUSINGS
BE	dr	angles	tolerances unless otherwise specified	INCH/MM	title
		0°±2'	XXX+01/XX+3	scale 1:1	MINI LATCH HOUSING
			XXX+005/XX+3		SINGLE ROW .100 [2.54] CC
			XXXX+0020/XXX+051		dwg no
		dr	M. CORNMAN	1990-01-31	sheet 12 of 12
		engr	H. SUNDY	1990-01-31	size
		chr	H. SUNDY	1990-01-31	65039
		appd	H. SUNDY	1990-01-31	A4
sheet index	revision sheet				type
					Product Customer Drawing

form A4mmXc

1 |

2 |

3 |

4

PDM: Rev:BE STATUS: Released Printed: May 01, 2009