

## HARSH ENVIRONMENT IP66 / IP68 EN3® SERIES CONNECTORS

### 26 AWG 9-18 CRIMP CONTACTS & STRAIN RELIEF SYSTEM

#### Features and Benefits

- Easy, no soldering connector wiring with crimp type contacts
- Secure cable clamp system accommodates cable diameters from 0.230" to 0.380"
- New heavier boot seals cable diameters up to 0.380"
- Gold plated contacts (standard) ensure reliability
- Fully complies with IP67/IP68/NEMA 250 (6P) requirements



Assembled EN3®  
Cord with  
Large Boot

#### Product Specifications

##### Materials

**Connector Shell, Contact Locking Disc:** Thermoplastic polymer glass fiber, flame retardant

**Cable Clamp:** High grade thermoplastic

**Boot, Connector Shell Interior:** Thermoplastic elastomer (TPE)

**Contacts:** Copper base alloy, gold plated over nickel underplate

##### Mechanical

**Shock:** Mil-Std 202 Method 213B, Condition K

**Vibration:** Mil-Std 202 Method 201A

**Life:** 600 insertion/withdraw cycles minimum

##### Electrical

**Voltage Rating (Sea Level):** Tested at 600 VRMS

**Insulation Resistance:** 100 megohms minimum at 77° F.

**Contact Resistance:** 5 milliohms maximum

**Current Rating:** 3 Amps

##### Environmental

**Temperature Limits:** -40° C to +65° C (non-operating)

**Moisture Resistance:** Mil-Std 202 Method 106F

**Insulation Resistance:** Mil-Std Method 302 Condition B

**Thermal Shock:** Mil-Std 202 Method 107G

**Salt Spray:** Mil-Std 202 Method 101D Condition B

**Water Tightness Test:** U.S. Coast Guard CFR 46 Part 110.20

##### Product Ratings

IP16/IP18

IP66/IP68

NEMA 250 (6P)



Panel Mount with  
Crimp Contacts



New Boot  
& Clamp with  
Retaining Nut

## Cable End

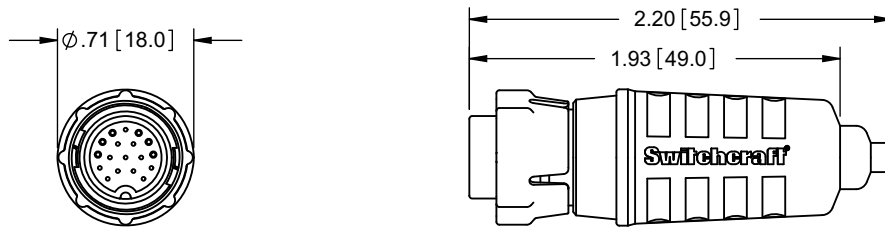

## Panel Mount

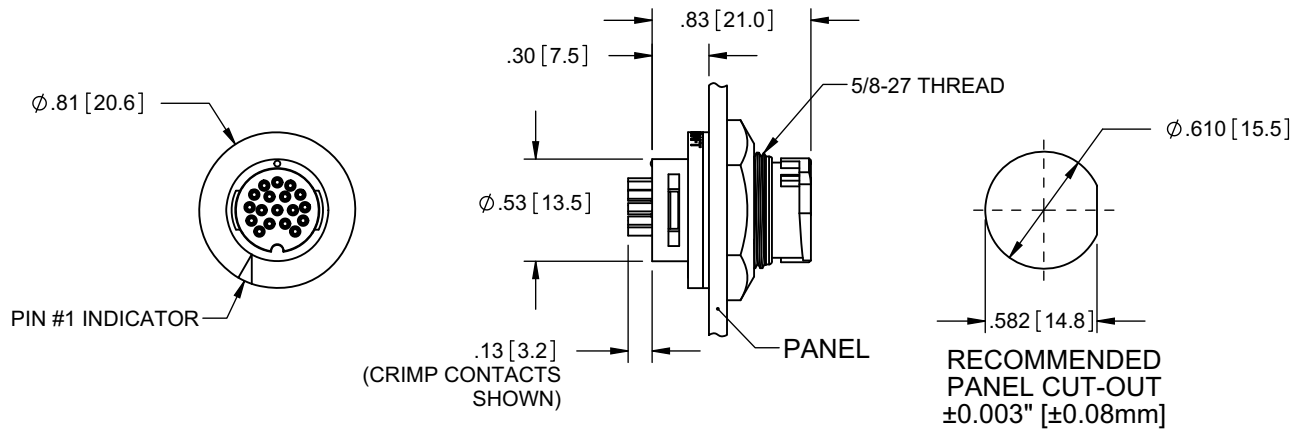

## In-Line

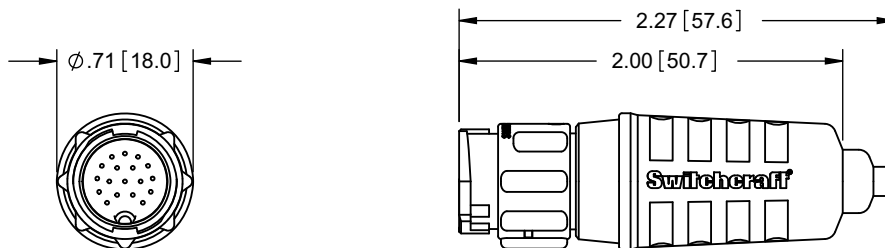

## Contact Arrangements (Wiring View of Cable End)

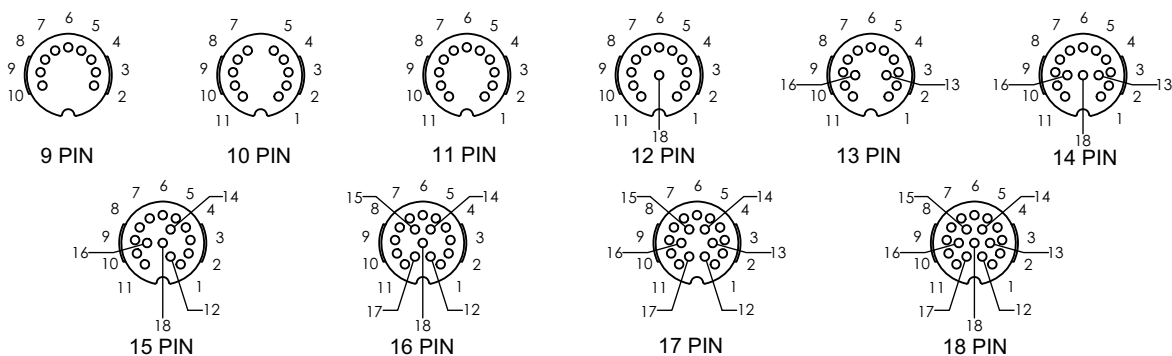

# Switchcraft®

www.switchcraft.com

5555 North Elston Avenue / Chicago, IL 60630  
Phone: 773-792-2700 / Fax: 773-792-2129

## NEW CABLE CLAMP SYSTEM FOR LARGER O.D. CABLE

For cable O.D. 0.230" to 0.380" [5.8 - 9.7] and maximum cable jacket stripping of 0.750" [19.1] long.

Note: Cable clamp system, for cable O.D. 0.090" to 0.265" [2.3 - 6.7] and maximum cable jacket stripping of 0.375" [9.5] long, still available.

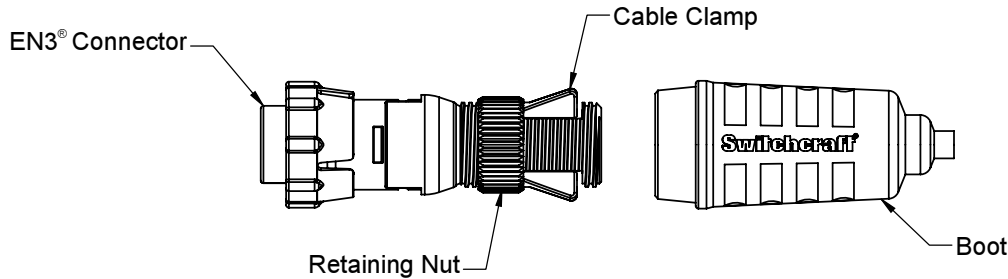

## EN3® SERIES IP68 CONNECTOR CAPS

### EN3IPCAP

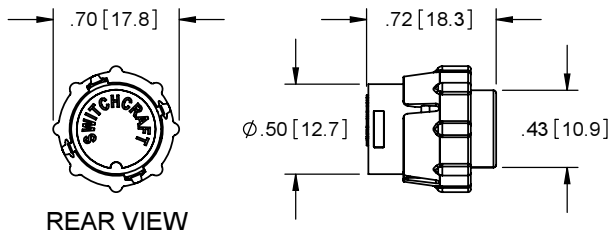

### EN3CAP

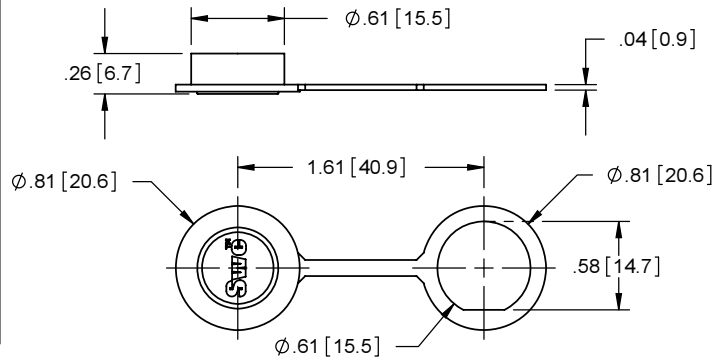

All dimensions for reference only.

## EN3® SERIES ORDERING CODE

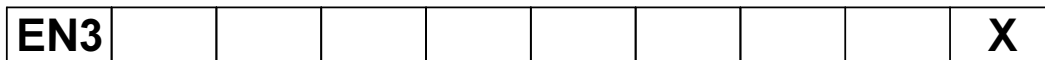

Connector Type:

- C - Cord
- P - Panel
- L - In-Line

# of Contacts:

- 2-3 for #16
- 2-8 for #20
- 9-18 for #26

Gender:

- M - Male
- F - Female

Contact Size:

- 16 - 16 AWG
- Leave blank for 20 AWG
- 26 - 26 AWG

Contact Style:

- C - Crimp
- P - PC tail
- S - Staggered Solder Cup
- Leave blank for Straight Solder Cup

Cable Clamp system option:

- L - for 0.230" to 0.380" cable nom. O.D. and 0.750" long stripping.
- Leave blank for 0.160" to 0.265" cable nom. O.D. and 0.380" long stripping.

Packaging Options:

- K - Kit
- Leave blank for Bulk

Contact plating:

- AG - Silver
- Leave blank for Gold

Notes:

- 7 and 8 pin not available in male Cord or In-Line connector
- 7 and 8 pin not available in female In-Line connector
- AG (silver plating) special order
- Suffix "X" in the ordering code number means the product is RoHS compliant.



www.switchcraft.com

5555 North Elston Avenue / Chicago, IL 60630  
Phone: 773-792-2700 / Fax: 773-792-2129

**EN3® SERIES FIELD ASSEMBLY INSTRUCTIONS FOR CRIMP CONTACTS:****STEP 1:**

PRESS THE TWO WINGS OF CABLE CLAMP INWARD, THEN THREAD NUT CLOCKWISE ONTO CABLE CLAMP TO THE POSITION SHOWN.

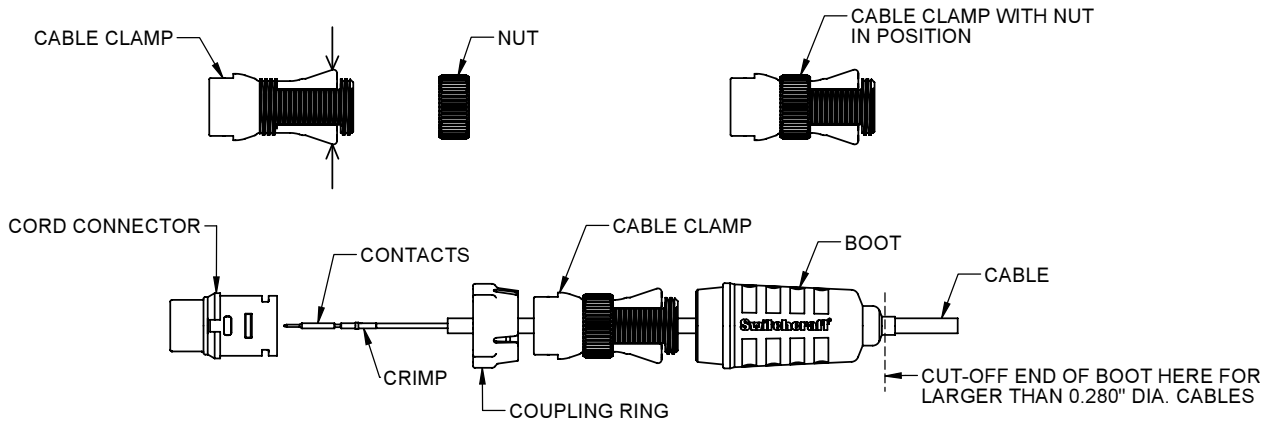
**STEP 2:**

FEED THE FREE END OF CABLE THROUGH BOOT, CABLE CLAMP, AND COUPLING RING IN THE ORDER SHOWN.

NOTE: CUT-OFF END OF BOOT FOR LARGER THAN 0.280" DIAMETER CABLES.

STRIP CABLE END AND CONDUCTORS AS SHOWN.

CRIMP CONDUCTORS TO CONTACTS.

USE CRIMP HAND TOOL **EN3CR** OR PNEUMATIC CRIMP TOOL

**EN3CRAUTO** WITH #26 POSITIONER **EN3POS26**

INSERT CONTACTS TO CONNECTOR HOUSING PER CONTACT ARRANGEMENTS AND INSERTION INSTRUCTIONS.

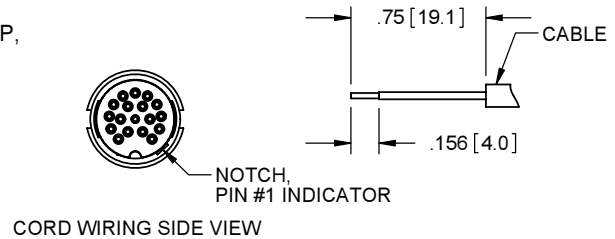
TYPICAL CONTACT INSERTION INSTRUCTIONS:

PLACE CONTACT IN GROOVE OF INSERTION HAND TOOL **EN3INS26**. NOTE: TIP OF TOOL SHOULD BE UP AGAINST THE SHOULDER OF CONTACT.

INSERT CONTACT INTO CORRECT CAVITY OF CONNECTOR BODY BY APPLYING CONSTANT PRESSURE UNTIL CONTACT BOTTOMS UP AGAINST LOCKING DISC. NOTE: DO NOT TILT TOOL DURING THE INSERTION.

REPEAT ABOVE PROCEDURE TO INSERT ALL CONTACTS PER CONTACT ARRANGEMENTS.

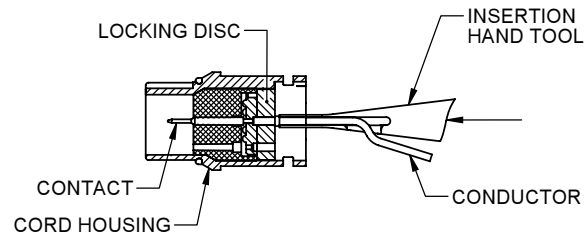
**STEP 3:**

ALIGN TABS OF COUPLING RING WITH NOTCHES OF CORD HOUSING AND PUSH COUPLING RING ONTO CORD HOUSING.

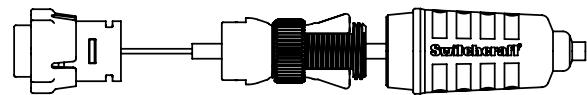
**STEP 4:**

ALIGN CABLE CLAMP AND PUSH FORWARD UNTIL IT SNAP-LOCKS ONTO THE REAR OF CONNECTOR HOUSING. TURN NUT OF CABLE CLAMP COUNTERCLOCKWISE UNTIL CABLE CLAMP TIGHTENS AGAINST CABLE.

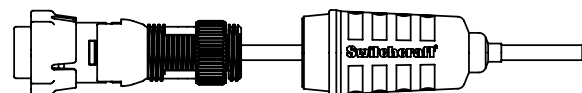
**STEP 5:**

PUSH BOOT ALL THE WAY FORWARD, OVER CABLE CLAMP, UNTIL FRONT END OF BOOT SEALS TIGHTLY ONTO CONNECTOR HOUSING.

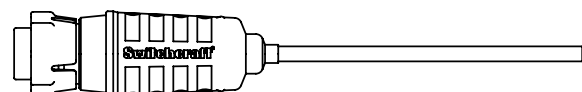

# Switchcraft®

[www.switchcraft.com](http://www.switchcraft.com)

5555 North Elston Avenue / Chicago, IL 60630  
Phone: 773-792-2700 / Fax: 773-792-2129