

Amphenol® High Frequency Contacts for Multi-pin Connectors

12-130-3



Amphenol

Table of Contents

	Page
INTRODUCTION	
Amphenol® Coax, Twinax and Triax Contacts	0 -3
Cable Usage Guides	4, 5
COAX, TWINAX AND TRIAX CONTACT INFORMATION BY CONNECTOR FAMILIES	
Subminiature Cylindrical Connectors Includes MIL-DTL-38999 types: LJT-R, JT-R, TV-R, Amphe-Lite, and SJT-R Series	6-21
Miniature Cylindrical Connectors Includes MIL-C-26482 types	22-29
Standard and Heavy Duty Cylindrical Connectors Includes MIL-C-5015 and MIL-C-22992 types	30-33
Rectangular Connectors	34, 35
TYPICAL CONTACT INSTALLATION INSTRUCTION FOR COAX CONTACTS	36
ADDITIONAL CONTACT STYLES AND CONNECTOR CONFIGURATIONS	37
Amphenol Sales Office and Distributor Listing	Back Cover

If more information is needed concerning the products in this publication, or if you have any special application needs, please contact your nearest Amphenol sales office or Amphenol Corporation at the address listed below.

Amphenol Corporation
Amphenol Aerospace
40-60 Delaware Avenue
Sidney, New York 13838-1395
Telephone: 800-678-0141
607-563-5011
Fax: 607-563-5157

Website: www.amphenol-aerospace.com

Amphenol Aerospace is a Certified ISO 9001 Manufacturer.

Amphenol Provides Interconnection Solutions

Amphenol is a leading designer, manufacturer and marketer of interconnection products, providing interconnects for military, aerospace and industrial applications worldwide. Offering the broadest range of products in the interconnection products industry, Amphenol supplies an immense array of connector series; many series within the military arena were developed by Amphenol. The Amphenol Corporation is known worldwide as the system designer's choice for electrical and optical connections when performance, quality and high reliability are paramount.

Amphenol offers a very wide range of contacts for most mil-spec and many proprietary connectors.

You can be assured of interconnection compatibility when you come to Amphenol for your contact needs as well as your connector needs.

Amphenol's expertise in interconnection solutions assures that your contacts will mate properly and will perform to the application specifications of your particular requirements.



This Contact Catalog provides information on the Shielded Coax, Twinax and Triax Contacts that Amphenol supplies for multi-pin connectors.

- Coax Contacts - designed for RF/microwave and shielded wire applications.
- Twinax Contacts - shielded twisted pair of conductors, designed for digital high speed data transmission systems.
- Triax Contacts - designed for shielded wire applications.

This catalog helps you determine the best coax, twinax or triax contact for your shielded wire requirements. Contact data is given according to connector series as follows:

- Contacts for Cylindrical connectors
 - Subminiature (MIL-DTL-38999* types)
 - Miniature (MIL-C-26482 types)
 - MIL-C-5015 types and Heavy Duty Cylindricals.
- Contacts for Rectangular connectors

Each section provides contact application data, insert arrangement availability and ordering information for contacts.

The Cable Usage Guide is a key reference to help guide you in selecting the contacts best suited to your needs. Since most shielded wire applications start with a fixed requirement for cable type, the guide refers you to each Amphenol connector family utilizing contacts which are compatible with the cable characteristics.

*Note: MIL-DTL-38999 supersedes MIL-C-38999



Part of Amphenol's 675,000 sq. ft. facility in upstate NY is a large contact production area which produces the wide variety of contacts for the many families of cylindrical and rectangular connectors also manufactured at Amphenol.



High technology computer driven centers at Amphenol Aerospace and Amphenol Industrial Operations result in quality production and cost reductions with shorter lead and delivery times.



Amphenol has the interconnection expertise to meet almost any connector application requirements in military aerospace, with an immense range of connector choices and contact choices.

Shielded Coax & Twinax Contacts

For multi-pin connector versatility

Amphenol® Shielded Contacts

Provide Design Versatility for Electrical Circuitry

Optional choices, other than standard crimp or solder 500 cycle and 1500 cycle contacts, are often required for high frequency interconnections. Contacts frequently require shielding to eliminate interference from outside electrical sources. Amphenol offers shielded contacts for RF applications as well as balanced high sensitivity circuits.

AMPHENOL® SHIELDED COAXIAL CONTACTS within a connector provide the shielding protection, and in many cases the RF/microwave performance, needed in the circuitry of many applications. All popular series of Amphenol cylindrical connectors and many rectangular connectors are available with coax contacts.

Diameters are standardized in sizes 4, 8, 12 and 16 so that coaxial contacts may be interchanged with power contacts in connector insert arrangements which include those sizes. Popular RG cable types and a variety of other commercial coaxial cables can be accommodated. See page 7 for coax contact performance data.

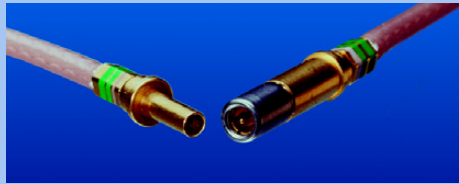

Shielded Coax Contacts

Matched impedance size 12 coax contacts are also available (see page 8). The use of coax contacts within a connector, compared to the use of individual coaxial/shielded connectors, offers advantages of savings in space and weight and no cross-mating difficulties. Coax and standard contacts may be mixed within the connector to meet special signal needs. The connector itself offers further protection and environmental integrity through the grommets and seals used, and coaxial junction is protected by the connector outer shell.

AMPHENOL® CONCENTRIC TWINAX SHIELDED

CONTACTS offer high performance shielding capabilities for protection from magnetic and electrostatic interference including nuclear electromagnetic pulse. The contact is crimp terminable to twisted shielded cable and is fully scoop-proof (recessed pins) in MIL-DTL-38999 connectors. The concentric twinax contact is engineered to maintain shield integrity through a multi-pin cylindrical connector and does not require contact polarization within the insert.

Size 8 concentric twinax contacts were developed for use in MIL-STD-1553B Airborne multiplex data bus applications. Ideal for this application need is the high performance Tri-Start connector with its fully scoop-proof feature of recessed pins. The concentric twinax contact is crimp terminable to twisted-shielded cable.

Size 12 concentric twinax contacts were developed for SAAB. They can be used in any size 12 cavity of D38999 I, II or III or SJT connector.

Amphenol® RCT (Reduced Component Twinax) contacts are another contact termination solution for MIL-STD-1760 and MIL-STD-1553 Data Bus requirements. It features 3 user-assembled components and is available in size 8 and size 10 contact sizes. Termination is completed in only two crimping operations.

Twinax contacts are covered on pages 12-15. Supporting application tools are available for crimping as well as installation and removal of contacts from connectors. Consult Amphenol, Sidney, NY for tooling information.



MIL-DTL-38999 Lanyard "Breakaway" Connector with Concentric Twinax contacts, Qualified for MIL-STD-1760.



MIL-DTL-38999 with Shielded Coax Contacts



Concentric Twinax Size 12 Contacts



Concentric Twinax Size 8 Contacts



RCT (Reduced Component Twinax) Contacts, Size 8

Twinax & Triax Contacts

For multi-pin connector versatility

AMPHENOL® TWINAX CONTACTS FOR PRINTED CIRCUIT BOARD APPLICATIONS Printed circuit tail twinax contacts provide a cost effective packaging solution for limited space applications where connectors are attached to printed circuit boards. They are available for MIL-DTL-38999 Series I and III cylindrical connectors and also for ARINC 404 and ARINC 600 rectangular connectors. High reliability is assured with factory pre-assembled contacts and standardized termination to the board. See pages 17-18 for performance data and ordering of PC tail twinax contacts, and consult Amphenol for any further information needed.

AMPHENOL® SHIELDED CONTACTS FOR GROUND PLANE CONNECTORS

Amphenol offers MIL-DTL-38999 Series III connectors for data bus, LAN and coax/triax/twinax transmission lines with conductive inserts that ground the outer conductor of the coax, triax or twinax contact to the shell. These connectors are sold "less contacts". They will accommodate size 8 & 12 coax, triax or twinax contacts or size 16 coax contacts.

AMPHENOL® SHIELDED TRIAX CONTACTS with three conductors are designed for use with triax cable. Amphenol supplies Triax contacts in sizes 8, 10 and 12 for use in MIL-DTL-38999 Series I, II and III connectors. Triax contacts provide additional shielding when terminated to triax cable having solid or stranded center conductors. See cable compatibility in the Cable Usage Guide for Triax contacts on page 5, and see performance data and ordering of triax contacts on pages 16-18. Each of the three conductors of the triax contact is separated by dielectric insulation to isolate ground planes and to improve shielding effectiveness. All conductors are crimp terminated for high reliability and ease of assembly. Triax contacts may be specified for direct connection to printed circuit boards. For maximum system flexibility, triax contacts may be mixed with coax, twinax and power contacts in a single connector.

AMPHENOL® OFFERS A WIDE RANGE OF OTHER CONTACT OPTIONS

For information on other types of contacts supplied by Amphenol such as:

- Standard 500 cycle and 1500 cycle contacts
- Thermocouples
- Wire wraps
- Printed Circuit Board Contacts
- Low Mating Force Brush Contacts
- Press-fit Compliant Contacts
- ARINC contacts
- Fiber Optic Termini
- RADSOK sockets

Consult Amphenol Connector Series catalogs. Catalogs are on-line on our website: www.amphenol-aerospace.com. The individual series catalogs will list the availability of the contact types that can be incorporated into the series. Page 37 of this catalog gives a brief overview of some of these additional contact types.

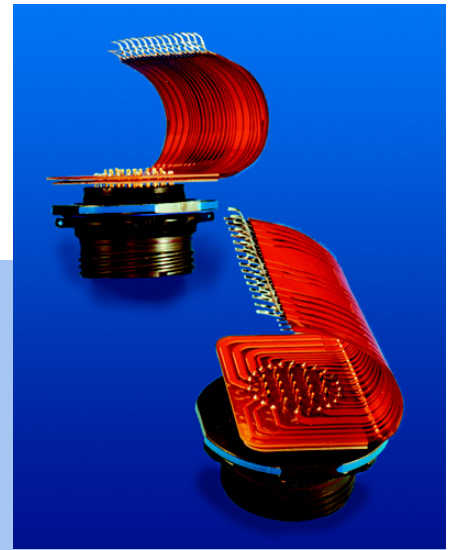

D38999 Connectors with PCB Tail Twinax Contacts



Amphenol offers a wide variety of PC Tail Twinax contacts

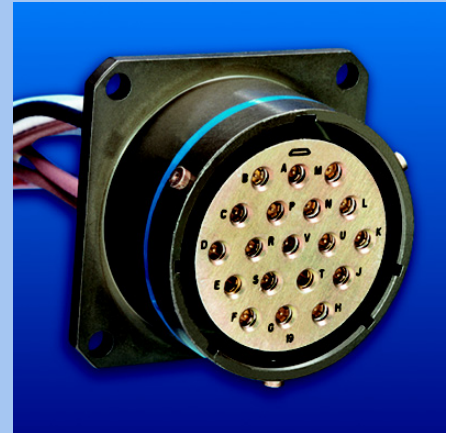

Ground Plane Connector with Metallic Insert and Concentric Twinax Contacts



Triax Contact

Cable Usage Guides

Use the Cable Usage Guides on this page and the next as follows:

1. Locate the cable you are using in **Cable Type** column.
2. Refer to the Amphenol connector section which features contacts for this cable, as indicated by a • in the appropriate column. If more than one connector series utilizes contacts designed for your cable, investigate each of them. Connector size, performance features and insert pattern availability may influence your choice.
3. Order your connector and **coax, twinax and/or triax contacts** by following the procedure given in the section for the connector series selected. These instructions are supplemented by the Amphenol Catalog Section covering the basic connector.
4. The **Additional Contacts** column of this guide is used to indicate an additional availability of contact designs for older cable types or capability. Consult Amphenol, Sidney, NY for further information.

COAX CONTACT CABLE USAGE GUIDE

Cable Type	Nominal Impedance (ohms)	For Subminiature Cylindricals (MIL-DTL-38999 type)	For Miniature Cylindricals (MIL-C-26482 type)		For Standard & Heavy Duty Cylindricals (MIL-C-5105 type) (MIL-C-22992 type)	For Rectangular Connectors	Additional Contacts (Consult Amphenol)
			Solder type	Crimp type			
RG-5B/U (M17/073-RG212)	50						•
RG-6A/U (M17/2-RG6)	75						•
RG-7/U	97						•
RG-9B/U (M17/075-RG214)	50						•
RG-11A/U (M17/6-RG11)	75						•
RG-12A/U (M17/6-RG12)	75						•
RG-13A/U	74						•
RG-21A/U	53						•
RG-55B/U (M17/084-RG223)	53			•	•	•	
RG-58C/U (M17/028-RG058)	50		•	•	•	•	
RG-58 (M17/155-00001)	50	•					
RG-59B/U (M17/29-RG59)	75		•	•	•		
RG-62A/U (M17/030-RG062)	93		•	•	•		
RG-62B/U	93		•	•	•		
RG-63B/U (M17/31-RG63)	125						•
RG-71B/U (M17/90-RG71)	93						•
RG-87A/U	50						•
RG-115/U	50						•
RG-115A/U	50						•
RG-116/U	50						•
RG-122/U (M17/054-RG122)	50			•		•	•
RG-133A/U (M17/100-RG133)	95						•
RG-140/U (M17/110-RG302)	75			•	•		
RG-141A/U	50		•	•	•	•	
RG-142A/U	50		•	•	•	•	•
RG-142B/U (M17/060-RG142)	50	•	•	•	•	•	•
RG-143A/U	50						•
RG-161/U	70	•	•	•	•		
RG-174A/U (M17/119-RG174)	50	•	•	•	•		
RG-178B/U (M17/093-RG178)	50	•	•	•	•		
RG-179B/U (M17/094-RG179)	75	•	•	•	•		
RG-180B/U (M17/095-RG180)	95	•	•	•	•	•	
RG-187A/U (M17/094-RG179)	75	•	•	•	•		
RG-188A/U (M17/113-RG316)	50	•	•	•	•		
RG-188 Double Braid	50			•			
RG-195A/U (M17/095-RG180)	95	•	•	•	•	•	
RG-195 Double Braid	95			•			
RG-196A/U (M17/169-00001)	50	•	•	•	•		
RG-210/U	93		•	•	•		
RG-212/U (M17/073-RG212)	50				•		•
RG-214/U (M17/075-RG214)	50						•
RG-216/U (M17/77-RG216)	75						•
RG-222/U	50						•
RG-223/U (M17/084-RG223)	50	•		•	•	•	
RG-225/U (M17/86-RG225)	50						•
RG-227/U	50						•
RG-302/U (M17/110-RG302)	75			•	•		
RG-303/U (M17/111-RG303)	50		•	•	•	•	
RG-304/U (M17/112-RG304)	50						•
RG-316/U (M17/113-RG316)	50	•	•	•	•		
RD-316 Double Braid (M17/152-00001)	50	•					
RG-400 (M17/128-RG400)	50	•					

Cable Usage Guides, cont.

COAX CONTACT CABLE USAGE GUIDE, CONT.

Cable Type	Nominal Impedance (ohms)	For Subminiature Cylindricals (MIL-DTL-38999 type)	For Miniature Cylindricals (MIL-C-26482 type)		For Standard & Heavy Duty Cylindricals (MIL-C-5105 type) (MIL-C-22992 type)	For Rectangular Connectors	Additional Contacts (Consult Amphenol)
			Solder type	Crimp type			
5M2869-001	50	•				•	
FA-19X	50	•					
T-Flex-405	50	•					
Filotex ET124962	50	•					
JN1088WT (Triax)	50	•					
JN1088WU (Triax)	75	•					
PAN6422XQ	50	•					
PAN6422XY	75	•					
PAN6595XM (Triax)	75	•					
Haveg 51-04486		•					
81-00207		•					
Gore GWN1159A		•					
CXN3403		•					
Times AA3248		•					
Teledyne 11299		•					
Raychem							
5021D1331-0	50						
5021D1331-9	50		•				
5022D1312-9	50		•				
7527A1318	75			•			
9528A1318	95	•					
9530A5314	95	•					
9530D5314	95			•			
Thermatics 2929-29			•				
Tensolite 30850/87T-1				•			
Thermax 50C-25A-DS-1				•			

TWINAX CONTACT CABLE USAGE GUIDE

Cable Type	Nominal Impedance (ohms)	For Subminiature Cylindricals (MIL-DTL-38999 type)	For Miniature Cylindricals (MIL-C-26482 Crimp type) (PT-DR)	For Rectangular Connectors (ARINC 600 Rack and Panel type)
EPD32263A	77	•		
EPD22189B	77	•		
M17/176-00002	77	•		
GSC-12-2548-00	77	•		
GC875TM24H	77	•		
GSC-12-81095-00	77	•		
Raychem 10602	77	•		
Raychem 10606	77	•		
Raychem 10612	77	•		
Raychem 10613	77	•		
Raychem 10614	77	•		
PAN6421			•	
PAN711-6421	77	•		
23089/RC		•		
05A0771	77	•		
T10971	77	•		
7724C8664	77	•		
7726D0664	77	•		
782OD0111 (20 AWG)	78	•		
5M2022-003	75	•		
0024G0024	100	•		
HS5930	77	•		
S280W502-1	100	•		•
CXN2268	100	•		

TRIAx CONTACT CABLE USAGE GUIDE

Cable Type	Nominal Impedance (ohms)	For Subminiature Cylindricals (MIL-DTL-38999 type)	For Miniature Cylindricals (MIL-C-26482 Crimp type) (PT-DR)	For Rectangular Connectors (ARINC 600 Rack and Panel type)
5M2397-002	75	•		
5M2559-001	95	•		
81264-01	95	•		
81264-02	75	•		
ST5M1323-001	95	•		
JN1088WU	75	•		
JN1088WT	50	•		
GSC-03-81497-00	75	•		
RG179 (Coax Cable)	75	•		
10602 (Twinax Cable)	77	•		
Champlain 81-00321A	75	•		
Champlain 81-00700	95	•		
Tensolite 28988/50823LXX-1	75	•		
Tensolite 28598/9C026LT-1	95	•		
Tensolite 26895/90334X-1	95	•		
Teledyne 13809	95	•		
Teledyne 11914/1	95	•		
Thermatics 12447	75	•		
Times AA6603	95	•		

Subminiature Cylindrical Connector Overview

Amphenol® Subminiature Connectors are ideally suited for the incorporation of shielded contacts for high performance interconnection applications. The Subminiature family is built around MIL-DTL-38999 specifications, with Mil-approved and proprietary styles offered. Normal operating voltage for Subminiatures with power contacts only is up to 900 VAC (RMS) at sea level.

Subminiature Cylindricals offer these features for contact termination flexibility:

- Widest selection of insert arrangements that can incorporate:
 - size 8, 12 and 16 Coax contacts
 - size 8 and 12 Twinax contacts
 - size 8 and 10 RCT (Reduced Component Twinax) contacts
 - size 8, 10 & 12 Triax contacts
- Wide selection of connector shell styles and sizes
- Scoop-Proof recessed design in LJT-R, TV-R and SJT-R connectors provide protection for contacts
- Standard power contacts are crimp rear release, qualified to MIL-C-39029
- Coax, Twinax, and Triax contacts employ the same retention system as power contacts, simplifying user substitution



LJT-R, D38999 Series I

See Catalog 12-090 for complete information on this series.

- Scoop-proof (recessed pins)
- Bayonet coupling, crimp termination
- Also available in solder termination types under MIL-C-27599 Series I



JT-R, D38999 Series II

See Catalog 12-090 for complete information on this series.

- Shorter profile connector series for applications requiring maximum space savings
- Bayonet coupling, crimp termination
- Also available in solder termination types under MIL-C-27599 Series II

GENERAL ORDERING INFORMATION

Amphenol Subminiature Cylindricals, which feature rear removable contacts, are normally supplied with a full complement of power contacts, separately packaged. Coax, twinax and triax contacts are ordered by part number as referenced in the part number charts on the following pages of this catalog, and are substituted for the power contacts at the time of the cable or equipment assembly. If the application is for coax, twinax or triax contacts only, the connector may be ordered *less contacts* and no power contacts will be supplied. Complete installation instructions for the coaxial and twinax and triax contacts are supplied within the contact package. See page 36 that gives a typical contact instruction sheet for coax contacts.

HOW TO ORDER:

- Select the Subminiature Series desired. (See features of each series referenced above). The catalog referenced for each series will be necessary to complete the connector ordering part number. (Catalogs are on-line at www.amphenol-aerospace.com).
 - Catalog 12-090 - JT-R, LJT-R Connectors
 - Catalog 12-092 - TV-R Connectors
 - Catalog 12-091 - SJT-R Connectors
 - Catalog 12-094 - Amphe-Lite (Industrial 38999 type)
- Select the coax, twinax and/or triax contacts that are needed from the tables on the following Subminiature Cylindrical pages that correspond to the cable being used.
- Select the insert arrangement to accommodate required number of contacts. See the Subminiature Cylindrical insert pattern illustrations on pages 19-21.
- Complete the connector part number from the connector series catalog, incorporating the chosen insert pattern number.
- If connector is ordered *less contacts*, power contacts and/or sealing plugs may be ordered separately to fill out the insert arrangement.



TV-R, Tri-Start, D38999 Series III

See Catalog 12-092 for complete information on this series.

- High performance capability series for both general duty and severe environment applications
- Offers the widest range of Subminiature Family Mil-Spec qualified options in contact and connector styles
- Threaded coupling; completely mates in one turn; crimp termination
- Superior EMI/EMP shielding effectiveness
- Scoop-proof design (recessed pins)
- Available in aluminum, stainless steel and firewall, or lightweight composite styles

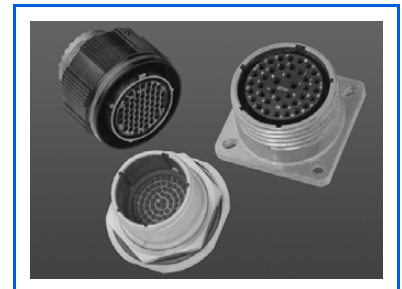

Amphe-Lite, 38999 Type

See Catalog 12-094 for complete information on this series.

- New Commercial/Industrial 38999 Series III type
- Offers a cost effective high performance connector for severe environments or general duty industrial applications
- Composite shells are lighter weight
- Scoop-proof design (recessed pins)
- Conductive finish available for EMI protection, or non-conductive finish option



SJT-R, 38999 Type

See Catalog 12-091 for complete information on this series.

- Amphenol proprietary series (non-MS) which is a further expansion of the basic JT family, but incorporates the LJT scoop-proof design
- Compliant with several European specifications

Coaxial Contacts for Subminiature Cylindricals

general description

Amphenol® Coaxial Contacts offer several advantages for reliable interconnection and continued performance:

- Large crimping area assures low contact resistance and high tensile strength
- Back insulator positively captivates inner contact against axial loads
- Front insulator provides closed entry for socket inner contact
- Recessed inner contact is protected
- Outer contact has rugged wall section for durability

TYPICAL SUBMINIATURE COAX SOCKET CONTACT has socket outer contact with a pin inner contact

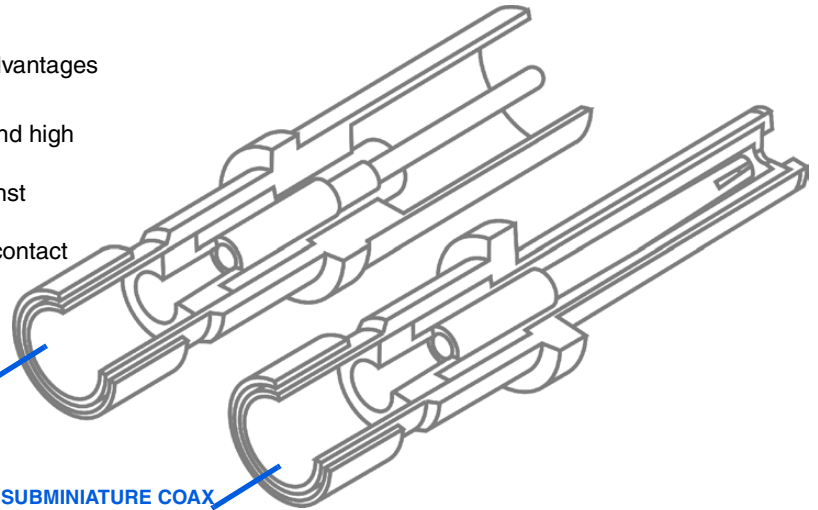

TYPICAL SUBMINIATURE COAX PIN CONTACT has pin outer contact with a socket inner contact

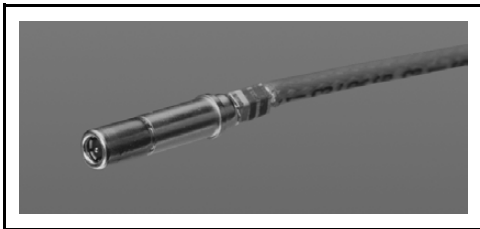

LJT-R, JT-R, TV-R, SJT-R MS Type, Coax Size 12 Socket Assembled Contact

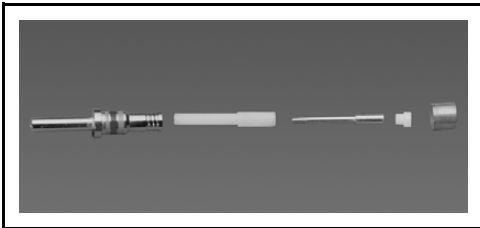

LJT-R, JT-R, TV-R, SJT-R MS Type, Coax Size 16 Pin Unassembled Contact



LJT-R, JT-R, TV-R, SJT-R MS Type, Coax Size 8 Pin Assembled Contact

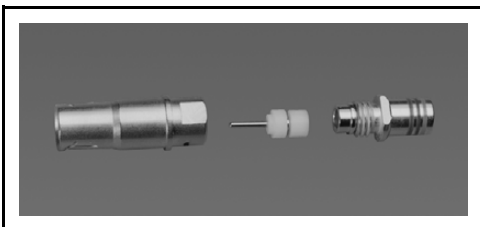

LJT-R, JT-R, TV-R, SJT-R MS Type, Coax Size 8 Socket Unassembled Contact

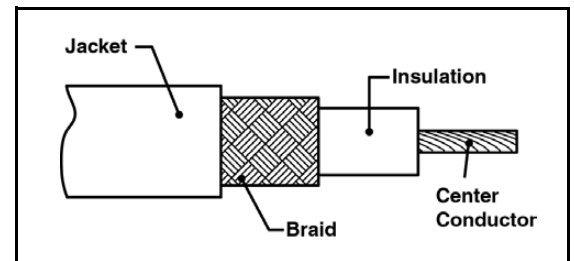

Cable Illustration - Coax Contact

Coax Contacts are gold plated, crimp termination

Finish of mating contacts parts: supplied with 0.000050 min. gold over nickel on mating parts. Other finishes are available; consult Amphenol for further information.

Coax Size 12 & 16 Contact Performance:

- Typical VSWR: 1.5:1 maximum up to 700 MHz and 500 MHz respectively, for properly cabled size 12 and 16 coaxial contacts in the M38999 Series I, II and III
- Insulation Resistance: 5,000 megohms minimum @ 25°C
- Dielectric Withstanding Voltage:
Size 12: 1,000 VAC Rms @ sea level, 250 VAC Rms @ 50,000 ft.
Size 16: 800 VAC Rms @ sea level, 250 VAC Rms @ 50,000 ft.
- Contact Resistance: See MIL-C-39029/27, /28, /75, /76, /77, /78

Coax Size 8 Contact Performance:

- Typical VSWR when terminated to specified 50 ohm cable: 1.5:1 maximum up to 3 GHz (excluding 21-33101/2-27)
- Insulation Resistance: 5,000 megohms minimum @ 25°C
- Dielectric Withstanding Voltage: 1,300 VAC Rms @ sea level, 250 VAC Rms @ 50,000 ft.
- Contact Resistance: See MIL-C-39029/59, /60

Matched Impedance Coaxial Contacts for Subminiature Cylindricals

Amphenol® Matched Impedance Size 12 Coaxial Contacts For RF/Microwave, High Frequency and High Performance Requirements

The matched impedance coax contact is available in size 12. It incorporates a captivated inner contact which “snaps into” the outer contact preventing displacement or pull back of the inner contact in situations where the cable may be bent.

TYPICAL MATCHED IMPEDANCE COAX SOCKET CONTACT
has socket outer contact with a captivated pin inner contact

TYPICAL MATCHED IMPEDANCE COAX PIN CONTACT
has pin outer contact with a captivated socket inner contact

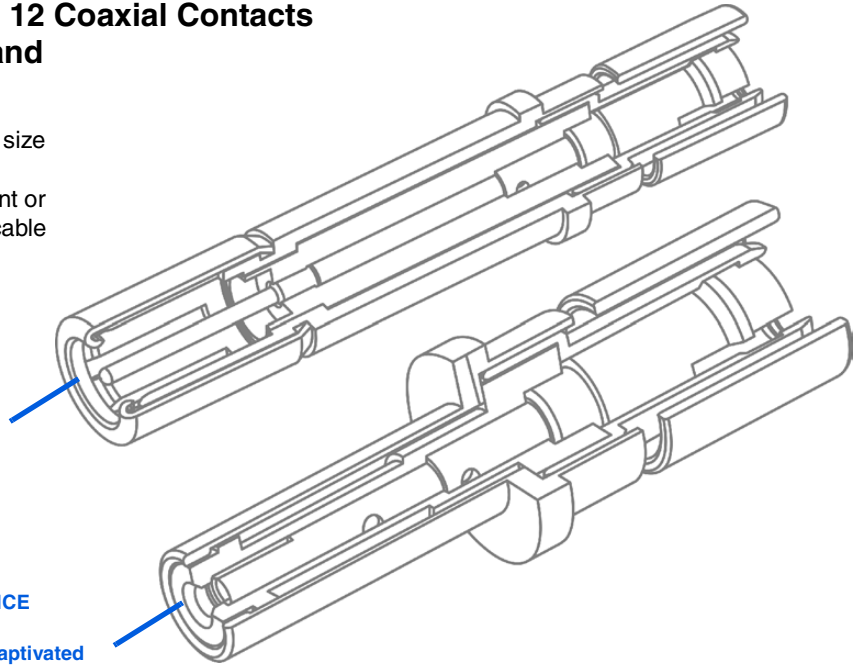

Design features and benefits of the Matched Impedance:

- For use in 90 degree angle or bent cable applications
- Provides 50 ohm matched impedance resulting in low VSWR and low insertion loss
- Frequency range for a mated pair extends to 3 GHz and beyond, higher than other coaxial contacts previously offered.
- Ideally suited for D38999 high performance and MIL-STD-1760 high band coaxial contact requirements

High Performance Size 12 Coax 50 Ohm matched

Use with Cable	Part Number	Pin	Socket
RG316, T-Flex-405	M39029/102/103	21-33651-11	21-33650-11
RD316, Filotex, ET124962, M17/152-00001	M39029/102/103 Type	21-33651-17	21-33650-17
JN1088WT	JN1104*50C	21-33213-42	21-33214-42
JN1088WT	JN1104*50T coax/triax	21-33909-31	21-33908-31
PAN6422XQ	PAN6841*50C	21-33651-12	21-33650-12
RG178, Gore CXN 3403	M39029/102/103 Type	21-33651-18	21-33729-018**

* Add P or S for pin or socket

** Series II D38999 socket

Matched Impedance Coax Contact Performance:

Electrical Specifications:

- Contact impedance = 50 ohms nominal
- Frequency range = 0–3 GHz
Operable at higher frequencies depending on cable selection. Consult Amphenol for details.
- Dielectric withstanding voltage (for a mated pair):
At sea level = 1000 VRMS
At 50, 000 ft. = 250 VRMS
- Insulation resistance: 5 gigaohms min. @ 25°C
- VSWR: 1.20 + .04F (F in GHz) max. up to 3 GHz
- Insertion Loss: .11 \sqrt{f} GHz dB max.

Environmental Specifications:

- Thermal limits: –55 ° to 200°C

Mechanical Specifications:

- Mating: slide-on
- Mounting: conforms to M39029/102 & /103 envelope dimensions

Coaxial Contacts for Subminiature Cylindricals

application data

JT-R Series, MIL-DTL-38999 Series II,
MIL-C-39029 (27, 28, 76, 78)

COAX CONTACTS FOR USE IN JT-R CONNECTORS											
Cable	Contact Part Number		Contact Size	Dimensional Data (See Drawings below)				Crimping Tools		Installation Tools	
				G Dia. ± 0.0005	H Dia. ± 0.0010	L Length Ref.		Inner Contact	Crimp Ferrule	Insertion	Removal
	Pin	Socket				Pin	Socket				
RG-178B/U, RG-196A/U	21-33122-564 (M39029/76-425)	21-33121-564 (M39029/78-433)	16	0.0150	0.0625	0.570	0.554	MIL-C-22520/2-01 with Positioner M22520/2-35 or with Daniels Positioner K532	M22520/4-01 with Positioner M22520/4-02	M81969/8-07 or M81969/14-03	M81969/8-08 or M81969/14-03
Haveg 30-00761 30-02024 30-02033 Tensolite 24713/A955KK1 26723/A955KK1	21-33122-562*	21-33121-562*								Amphenol 11-8674-16 11-8794-16 or MS27495A16 or MS27534-16	Amphenol 11-8675-16 11-8795-16 or MS27495R16 or MS27534-16
Haveg 61-02051	21-33122-561*	21-33121-561*									
RG-174A/U, RG-188A/U, RG-161/U, RG-187A/U, RG-316/U, RG-179B/U, Haveg 8100207, Times (HS-179) AA3248 Teledyne 11299	21-33122-563 (M39029/76-424)	21-33121-563 (M39029/78-432)	12	0.0200	0.0940	0.570	0.554	MIL-C-22520/2-01 with Positioner M22520/2-34 or with Daniels Positioner K323	MIL-C-22520/31-01 with Positioner M22520/31-02 or Daniels GS-200 Tool with Positioner G2P330	M81969/8-09 or M81969/14-04	M81969/8-10 or M81969/14-04
RG-180B/U, RG-195A/U, Raychem 9528A1318	21-33122-541 (M39029/28-409)	21-33121-541 (M39029/27-402)								Amphenol 11-8674-12 11-8794-12 or MS27495A12 or MS27534-12	Amphenol 11-8675-12 11-8795-12 or MS27495R12 or MS27534-12
Raychem 5022E5111	21-33122-543*	21-33121-543*									
Raychem 9530A5314	21-33122-544	21-33121-544									
Raychem 9527A1318	21-33122-545	21-33121-545									
Gore GWN1159A	21-33122-547*	21-33121-547*									
RG-178, Gore CXN3403	21-33651-18	21-33729-18									

* Consult Amphenol, Sidney NY for availability.

SUBMINIATURE CONTACT DATA

All contacts mate with other contacts in this series which have the same inner and outer contact diameters (G and H dimensions).

JT

Example: Socket 21-33121-564 on RG-196A/U cable will mate with pin 21-33122-563 on RG-188A/U cable which is used in both this and the LJTR series.

LJT, TV, SJT,
Ampe-Lite

Example: Socket 21-33123-564 on RG-196A/U cable will mate with pin 21-33122-563 on RG-188A/U cable which is used in both this and the JT-R series.

Installation instructions are packaged with each contact and can be found on-line at www.amphenol-aerospace.com (from home page, go to Tech Support, Service Instructions and enter contact part number).

Finish of mating contact parts: Contact part numbers shown in the chart above are supplied with 0.000050 min. gold (Knoop hardness 130-200) over nickel on mating parts.

Other finishes are available; consult Amphenol.

Daniels crimping tools are available from:

Daniels Mfg. Corp. 6103 Anno Ave., Orlando FL 32809

TYPICAL ILLUSTRATION OF COAX CONTACT FOR SUBMINIATURE CONNECTORS

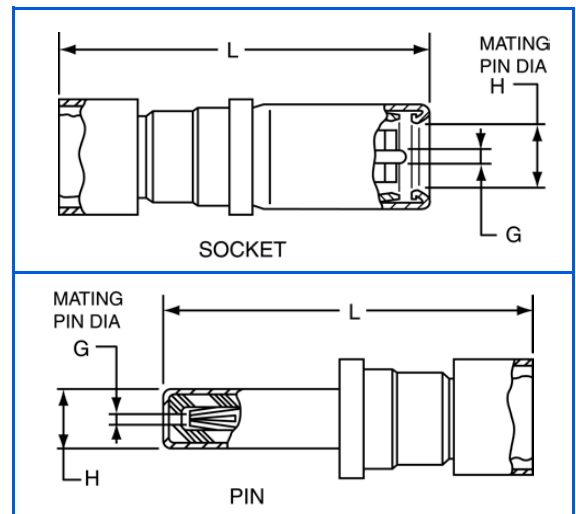

Coaxial Contacts for Subminiature Cylindricals

application data, cont.

LJT-R, MIL-DTL-38999 Series I; TV-R, MIL-DTL-38999 Series III; Amphe-Lite and SJT-R Series, MIL-C-39029 (28, 59, 60, 75, 76, 77)

COAX CONTACTS FOR USE IN LJTR, TVR, AMPHE-LITE AND SJTR CONNECTORS												
Cable	Contact Part Number		Contact Size	Dimensional Data (See Drawings pg. 9)				Crimping Tools		Installation Tools		
				G Dia.	H Dia. ±0.0010	L Length Ref.						
	Pin	Socket				Pin	Socket	Inner Contact	Crimp Ferrule	Insertion	Removal	
RG-178B/U, RG-196A/U	21-33122-564 (M39029/76-425)	21-33123-564 (M39029/77-429)	16	0.0150 ± 0.0005	0.0625	0.570	0.891	MIL-C-22520/2-01 with Positioner M22520/2-35 or with Daniels Positioner K532	M22520/4-01 with Positioner M22520/4-02	M81969/8-07 or M81969/14-03	M81969/8-08 or M81969/14-03	
Haveg 30-00761 30-02024 30-02033 Tensolite 24713/A955KK1 26723/A955KK1	21-33122-562*	21-33123-562*								Amphenol 11-8674-16 11-8794-16	Amphenol 11-8675-16 11-8795-16	
Haveg 61-02051	21-33122-561*	21-33123-561*								MS27495A16 or MS27534-16	MS27495R16 or MS27534-16	
RG-174A/U, RG-188A/U, RG-316/U, RG-161/U, RG-187A/U, RG-179B/U, Haveg 8100207, Times (HS-179) AA3248 Teledyne 11299	21-33122-563 (M39029/76-424)	21-33123-563 (M39029/77-428)								12	0.0200 ± 0.0005	0.0940
RG-180B/U, RG-195A/U, Raychem 9528A1318	21-33122-541 (M39029/28-409)	21-33123-541 (M39029/75-417)	Amphenol 11-8674-12 11-8794-12	Amphenol 11-8675-12 11-8795-12								
Raychem 5022E5111	21-33122-543*	21-33123-543*	MS27495A12 or MS27534-12	MS27495R12 or MS27534-12								
Raychem 9530A5314	21-33122-544*	21-33123-544*	M22520/5-01 with die set M22520/5-03 (A) or M22520/5-08 (A) M22520/5-35 (B) or M22520/10-01 with Die Set M22520/10-05 (A)	hand inserted	11-9170 or MS							
Raychem 9527A1318	21-33122-545*	21-33123-545*										
Gore GWN1159A	21-33122-547	21-33123-547										
RG-187A/U, RG-179B/U, RG-174A/U, RG-188A/U, RG-316/U, RG-161/U Haveg 8100207 Times (HS-179) AA3248 Teledyne 11299	21-33102-23*	21-33101-23*				MIL-C-22520/2-01 with Positioner M22520/2-31** or solder	M22520/5-01 with die set M22520/5-05 (A) or M22520/5-19 (B) or M22520/10-01 with Die Set M22520/10-07 (A)	M22520/5-01 with die set M22520/5-05 (A) or M22520/5-19 (B) or M22520/10-01 with Die Set M22520/10-07 (A)				
RG-142B/U, RG-223/U	21-33102-24*	21-33101-24*										
Haveg 51-03111 Tensolite 28895/2X1	21-33102-22	21-33101-22										
RG-180B/U, RG-195A/U, Raychem 9528A1318	21-33102-21 (M39029/60-367 Supersedes MS27536)	21-33101-21 (M39029/59-366 Supersedes MS27535)	8	0.0355 ± 0.0010	0.218	1.053	1.160					

NOTE: Contacts can be ordered by part numbers given in chart

* Consult Amphenol, Sidney NY for availability

** When inner contact is installed by crimping only. 11-10134 Expander Tool Kit must be used to assemble rear insulator over contact.

CRIMPING TOOLS: Italicized letters in parenthesis that follow positioner part numbers indicate applicable die closure. Commercial equivalents with the same die closure dimension may be used.

CHART CONTINUES ON NEXT PAGE

Coaxial Contacts for Subminiature Cylindricals

application data, cont.

LJT-R, MIL-DTL-38999 Series I; TV-R, MIL-DTL-38999 Series III; Amphe-Lite and SJT-R Series, MIL-C-39029 (28, 59, 60, 75, 76, 77), cont.

COAX CONTACTS FOR USE IN LJTR, TV-R, AMPHE-LITE AND SJT-R CONNECTORS, CONT.											
Cable	Contact Part Number		Contact Size	Dimensional Data (See Drawings pg. 9)				Crimping Tools		Installation Tools	
				G Dia.	H Dia. ±0.0010	L Length Ref.		Inner Contact	Crimp Ferrule	Insertion	Removal
	Pin	Socket				Pin	Socket				
RD-316 Double Shield (M17/152-00001)	21-33102-25	21-33101-25	8	.0355 ± 0.0010	0.218	1.053	1.16	M22520/2-01 with Positioner M22520/2-31	M22520/5-01 with Die Set M22520/5-37 (B) or M22520/10-01 with Die Set M22520/10-15 (A)	hand inserted	11-9170 or MS
RG-400	21-33102-27	21-33101-27						M22520/2-01 with Positioner M22520/2-10	M22520/5-01 with Die Set M22520/5-45 (A)		
RG-58 (M17/155-00001)	21-33102-29	21-33101-29						Solder	M22520/5-01 with Die Set M22520/5-05 (B)		
5021D1331-0	21-33102-36	21-33101-36						M22520/2-01 with Positioner M22520/2-31	M22520/5-01 with Die Set M22520/5-05 (B) or M22520/10-01 with Die Set M22520/10-07 (B)		
5M2869-001	21-33102-37	21-33101-37						M22520/2-01 with Positioner M22520/2-31	M22520/5-01 with Die Set M22520/5-05 (B) or M22520/10-01 with Die Set M22520/10-07 (B)		
FA-19X	21-33652-001	21-033653-001						M22520/2-01 with Positioner K1106	M22520/5-01 with Die Set Y25 (B)		
RG-316, RG-179, T-Flex-405	21-33651-011	21-33650-011	12	0.0200 ± 0.0005	0.094	0.556	0.884	MH992 (Daniels) with Positioner K1360	M22520/5-01 with Die Set M22520/5-03 (A) or M22520/5-35 (B)	hand inserted	11-9170 or MS
RD-316, M17/152-0001, Filotex ET 124962	21-33651-017	21-33650-017						MH992 (Daniels) with Positioner K1360	M22520/31-01 with Die Set GP959 (Daniels)		
JN1088WT & WU	21-33213-042	21-33214-042						MH992 (Daniels) with Positioner K1361	M22520/5-01 with Die Set M22520/5-03 (A) or M22520/5-35 (B)		
JN1088WU	21-33213-043	21-33214-043						MH992 (Daniels) with Positioner K1362			
PAN6422XQ	21-33651-012	21-33650-012						MH992 (Daniels) with Positioner K1360			
PAN6422XY, PAN6595XM	21-33651-014	21-33650-014						MH992 (Daniels) with Positioner K1361			

NOTE: Contacts can be ordered by part numbers given in chart
Consult Amphenol, Sidney NY for availability

** When inner contact is installed by crimping only. 11-10134 Expander Tool Kit must be used to assemble rear insulator over contact.

CRIMPING TOOLS: Italicized letters in parenthesis that follow positioner part numbers indicate applicable die closure. Commercial equivalents with the same die closure dimension may be used.

Twinax Contacts for Subminiature Cylindricals

general description, application data - size 12

Amphenol® Twinax Contacts were designed for use with twinax cable in Data Bus systems. Twinax contacts provide the following benefits:

- Protection from magnetic interference
- Protection from electrostatic interference including nuclear electromagnetic pulse
- Meets parameters defined by MIL-STD-1553B
- Maintains shield integrity through a multi-pin cylindrical connector and does not require contact polarization within the insert

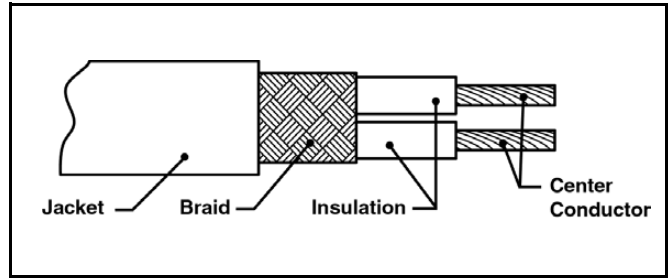

Cable Illustration - Twinax Contact

SIZE 12 CONCENTRIC TWINAX CONTACTS

The size 12 concentric twinax contact interface was developed for JN1104 EuroFighter contacts, and can be used in any size 12 cavity M38999 I, II or III or SJT connector.

Features:

- Operating temperature -55°C to 175°C
- Pins are scoop-proof
- Meets performance levels of M38999 connector
- 4 components, gold plated crimp termination
- For use with a variety of cables (See chart below)

TYPICAL ELECTRICAL PERFORMANCE

Size 12 Concentric Twinax Contacts

Voltage Rating:

500 Vrms max. @ sea level

Contact Resistance:

Center @ 1 Amp, 55 millivolts max. voltage drop @ 25°C

Intermediate @ 1 Amp, 55 millivolts max. voltage drop @ 25°C

Outer @ 12 Amps, 85 millivolts max. voltage drop @ 25°C

Operating Frequency: 0-30 MHz

Dielectric Withstanding Voltage:

Center to Intermediate 800 VAC Rms @ Sea Level

Intermediate to Outer 500 VAC Rms @ Sea Level



Concentric Twinax Contacts Size 12

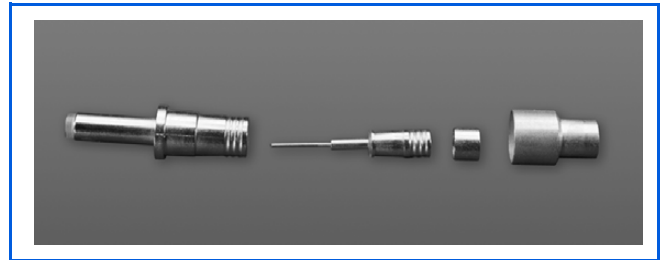

Unassembled Components of Size 12 Concentric Twinax Contact

SIZE 12 CONCENTRIC TWINAX CONTACTS FOR USE IN D38999 CONNECTORS				
For use with Cable	Size 12 Concentric Twinaxial Contact Part Number		Comments	Connector Series
	Pin	Socket		
EPD32263A, GSC-12-2548-00	21-33909-22	21-33908-22	JN1104 Interface	D38999 Series I, III
M17/176-00002	21-33909-25	21-33908-25		
GSC-12-81095-00	21-33909-26	21-33908-26		
GSC-12-81095-00		21-33640-26		D38999 Series II
0024A0024	21-33909-28	21-33908-28		D38999 Series I, III
EPD32263A, 10612, GSC-12-2548-00	21-33909-29	21-33908-29		

NOTE: Contacts can be ordered by part numbers given in chart

Twinax Contacts for Subminiature Cylindricals

general description, application data - size 8

High performance connectors within the D38999 families are the most commonly used connectors for incorporation of twinax contacts. These connectors offer wide versatility in insert arrangements for not only concentric twinax contacts, but also coax, triax, PCB, wire wrap, thermo-couples and EMI filter contacts.

Other connectors available with concentric twinax contacts:

- Wire Integrated Connectors (WICS) for Data Bus Systems. Consult Amphenol Aerospace, Sidney, NY.
- ARINC 404 and ARINC 600 rectangular connectors. Supplied by Amphenol Canada.

SIZE 8 CONCENTRIC TWINAX CONTACTS

The size 8 concentric twinax contact was developed for use in MIL-STD-1553 Airborne multiplex data bus applications which require high performance interconnect characteristics in multi-pin connectors. Ideal for this application need is the high performance Tri-Start connector with its fully scoop-proof feature of recessed pins. The concentric twinax contact is crimp terminable to twisted shielded cable. Features include:

- Provides protection from magnetic and electrostatic interference including nuclear electromagnetic pulse
- Maintains shield integrity through a multi-pin cylindrical connector and does not require contact polarization within the insert
- 175°C rated and meets performance levels of MIL-DTL-38999 Series III connectors
- MIL-C-17/176-00002 cable termination
- Gold plated full crimp termination contacts qualified to M39029/90 & /91
- Integral part of the MIL-STD-1760 interconnection system
- Also available in modified but intermateable versions for termination to a host of cables (See chart on next page)

TYPICAL ELECTRICAL PERFORMANCE

Size 8 Concentric Twinax Contacts

Voltage Rating: 500 Vrms max. @ sea level

Contact Resistance:

Center @ 1 Amp, 55 millivolts max. voltage drop @ 25°C

Intermediate @ 1 Amp, 55 millivolts max. voltage drop @ 25°C

Outer @ 12 Amps, 75 millivolts max. voltage drop @ 25°C

Operating Frequency: 0–20 MHz

Dielectric Withstanding Voltage:

Center to Intermediate: 1000 VAC Rms @ Sea Level

Intermediate to Outer: 500 VAC Rms @ Sea Level

TWINAX CONTACTS OPTIONAL DESIGNS

A 90 Degree size 8 Twinax and a Short Profile size 8 Twinax are available designs that both offer increased packaging efficiency. Consult Amphenol, Sidney, NY for further information on these contact options.

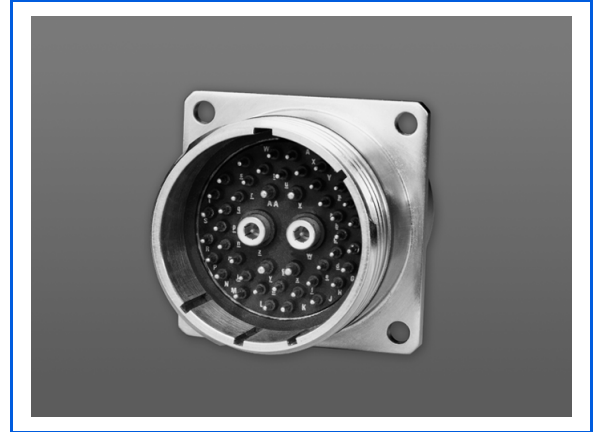

Subminiature MIL-DTL-38999 Series III Connector with Twinax Contacts and Standard Contacts



Concentric Twinax Contacts Size 8

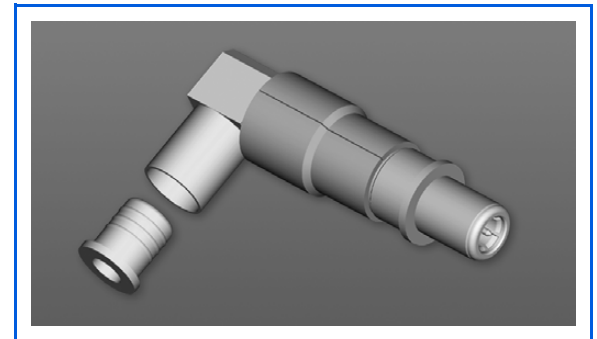

Size 8, 90 Degree Twinax Pin Contact for use in Series I, II and III D38999 Connectors

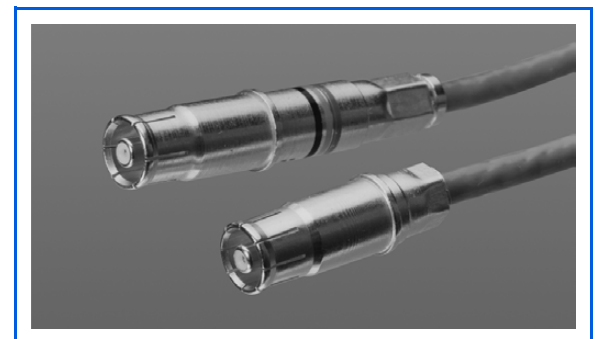

Short Profile Twinax vs Standard Length Twinax Contact

Twinax Contacts for Subminiature Cylindricals

general description, application data - size 8, cont.

SIZE 8 CONCENTRIC TWINAX CONTACTS FOR USE IN D38999 CONNECTORS				
For use with Cable	Size 8 Concentric Twinaxial Contact Part Number		Comments	Connector Series
	Pin	Socket		
M17/176-00002	21-33190-529	21-33191-530	M39029/90/91 (Amphenol) Supplied with heat shrink seal	D38999 Series I, III
M17/176-00002	T3-46T08-LD	T3-47T08-LD	M39029/90/91 (Pyle) Supplied with heat shrink seal	
M17/176-00002	21-33190-000	21-33191-000	Supplied without seal	
M17/176-00002	21-33190-001	21-33191-001	Supplied with piggyback grommet seal	
Raychem 10612	21-33190-26	21-33191-26		
Raychem 10614, EPD22189B, 7724C8664, 05A0771, GC875TM24H, T10971	21-33190-22	21-33191-22		
Raychem 10613, PAN711-6421, 23089/RC	21-33190-27	21-33191-27	Heat Shrink Seal	
Raychem 10613, PAN711-6421, 23089/RC	21-33190-30	21-33191-30		
GSC-12-2548-00, 7726D0664	21-33190-40	21-33191-40	Supplied with piggyback grommet seal	
Raychem 10614, 7724C8664	T3-46TB08-LD	T3-47TB08-LD		
5M2022-003, HS5930, 0024G0024, Raychem 10602	P-209527	P-209528		
782OD0111 (20 AWG)	T3-467C08-LD	T3-477C08-LD		
M17/176-00002	21-33625-1		90 Degree	
S280W502-1	21-33190-71	21-33191-71	Supplied with piggyback grommet seal	
CXN2268	T3-46TE08-LD	T3-47TE08-LD	Short Profile	
M17/176-00002	T3-46TD08-LD	T3-47TD08-LD		
M17/176-00002	21-33910-15	21-33922-15		
M17/176-00002	21-33617-1		Short Profile with piggyback grommet seal	
CNX2702	T3-46TF08-LD	T3-47TF08-LD	Short Profile	
M17/176-00002		P-209546-27		

NOTE: Contacts can be ordered by part numbers given in chart.

Twinax Contacts for Subminiature Cylindricals

general description, application data - RCT Contacts

Amphenol® RCT (Reduced Component Twinax)

Contacts - contact assembly and termination for MIL-STD-1760 and MIL-STD-1553 Data Bus requirements.

- 3 user-assembled components
- Available in size 8 or size 10 contact sizes
- MIL-C-17/176-00002 and other various cable termination
- Termination completed in only two crimping operations
- Inner conductors stripped to common length

The size 8 reduced component twinax contact meets MIL-C-39029/90 and /91 requirements for intermateability and performance, while reducing the number of user-assembled components from seven to three.

The reduced component twinax can be installed in MIL-DTL-38999* Series I or III connectors, and can be terminated to MIL-C-17/176-00002 cable, with other cable versions available with minor modifications. (see chart below)

The inner conductors and outer barrel are each terminated to the cable by a crimp joint, so no costly assembly soldering operation is required.

As the inner conductors are stripped to a common length, multiple measurements are eliminated. Assembly instructions are included in the packaging of the contacts.

* MIL-DTL-38999 supersedes MIL-C-38999

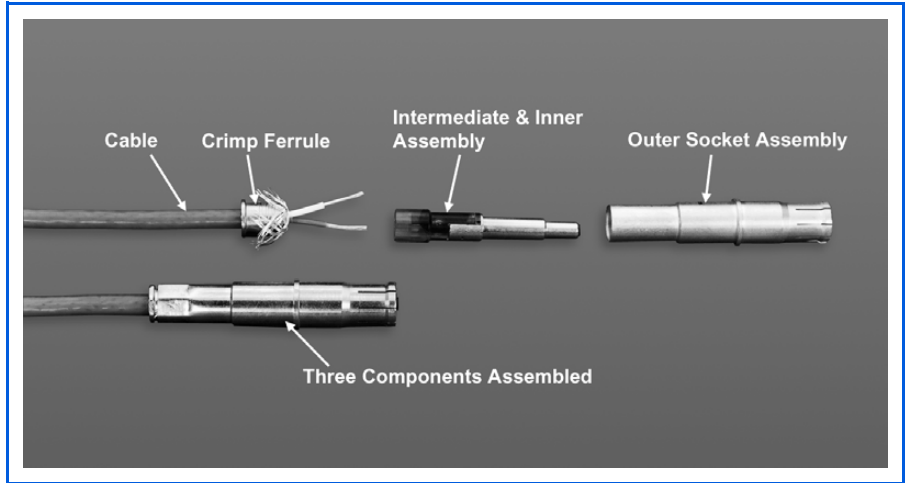

RCT (Reduced Component Twinax Size 8 Contact)

TYPICAL ELECTRICAL PERFORMANCE Size 8 & 10 Reduced Component Contacts

Voltage Rating: 500 Vrms max. @ sea level

Contact Resistance:

Center @ 1 Amp, 55 millivolts max. voltage drop @ 25°C

Intermediate @ 1 Amp, 55 millivolts max. voltage drop @ 25°C

Outer @ 12 Amps, 75 millivolts max. voltage drop @ 25°C

Operating Frequency: 0–20 MHz

Dielectric Withstanding Voltage:

Center to Intermediate 1000 VAC Rms @ Sea Level

Intermediate to Outer 500 VAC Rms @ Sea Level

SIZE 8 & 10 REDUCED COMPONENT CONTACTS FOR USE IN D38999 CONNECTORS					
For use with Cable	Size	Size 8 & 10 Reduced Component Contact Part Number		Comments	Connector Series
		Pin	Socket		
M17-176-00002	8	21-33876-3	21-33875-3	Supplied with Heat Shrink Seals	D38999 Series I, III
M17-176-00002	8	21-33876-1	21-33875-1	Without Seals	
M17-176-00002	8	21-33876-2	21-33875-2	With Piggyback Seal	
Raychem 10612	8	21-33190-25	21-33191-25		
CXN2268	8	21-33876-65	21-33875-65		
5M2022-003 HS5930 0024G0024 Raychem 10602	8	21-33190-6	21-33191-6		
5M2022-003	10	21-33844-1	21-33843-1		
Raychem 10606	8	21-33190-34	21-33191-34		
0024A0311	8	21-33876-5	21-33875-5		

NOTE: Contacts can be ordered by part numbers given in chart.

Triax Contacts for Subminiature Cylindricals

general description, application data

Amphenol® Triax Contacts provide additional shielding when terminated to triax cable having solid or stranded center conductors. Amphenol supplies triax contacts in sizes 8, 10 and 12 and they are ideally suited for use in D38999 Series I, II and III cylindrical connectors.

Features and benefits of Amphenol triax contacts include:

- Incorporates three conductors, designed for use with triax cable
- Each of the three conductors are separated by dielectric insulation to isolate ground planes
- Shielding effectiveness is improved with two isolated shields
- May be specified for direct connection to printed circuit boards
- May be mixed with coax, twinax and power contacts in a single connector

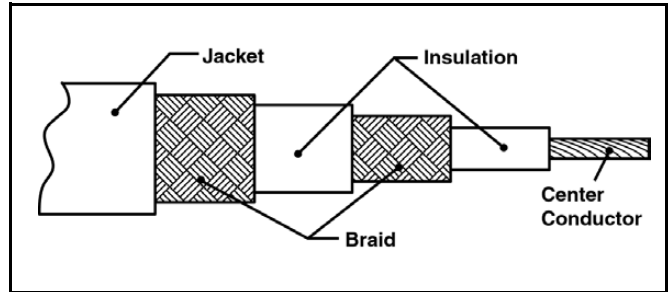

Cable Illustration - Triax Contact



Triax Size 8 Pin Contact

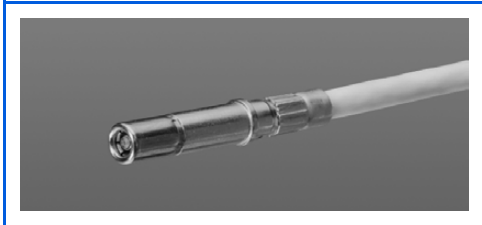

Triax Size 12 Socket Contact

TYPICAL ELECTRICAL PERFORMANCE

Size 8, 10 and 12 Triax Contacts

Contact Resistance:

Center @ 1 Amp, 120 millivolts max. voltage drop @ 25°C
 Intermediate @ 1 Amp, 60 millivolts max. voltage drop @ 25°C
 Outer @ 1 Amp, 90 millivolts max. voltage drop @ 25°C

Operating Frequency:

Size 12: 0-30 MHz
 Size 10: 0-300 MHz
 Size 8: 0-500 MHz

Dielectric Withstanding Voltage:

Center to Intermediate 800 VAC Rms @ Sea Level
 Intermediate to Outer 500 VAC Rms @ Sea Level

Insulation Resistance:

1000 megohms minimum @ 25°C

SIZE 8, 10 & 12 TRIAX CONTACTS FOR USE IN D38999 SERIES I & III CONNECTORS

For use with Cable	Size	Size 8, 10, 12 Triax Contact Part Number	
		Pin	Socket
5M2397-002, 81264-02, Champlain 81-00321A, Tensolite 28988/50823LXX-1, Thermatics 12447	8	21-33198-003	21-33197-003
5M2559-001, 81264-01, Tensolite 28598/9C026LT-1, Teledyne 13809	8	21-33198-004	21-33197-004
ST5M1323-001, Champlain 81-00700, Teledyne 11914/1, Times AA6603, Tensolite 26895/90334X-1	8	21-33198-010	21-33197-010
5M2397-002	10	21-33800-001	21-33801-001
JN1088WU, JN1088WT	12	21-33909-012	21-33908-012
GSC-03-81497-00	12	21-33909-023	21-33908-023

Coax, Twinax & Triax PC Tail Contacts for Subminiature Cylindricals

general description, application data

Amphenol® Printed Circuit Tail Contacts

are currently supplied as follows:

- 8, 12 and 16 Coax
- 8, 10 and 12 Twinax
- 8 Triax (socket only)

PC Tail shielded contacts provide a cost effective packaging solution for limited space applications where connectors are attached to printed circuit boards. High reliability is assured with factory pre-assembled contacts and standardization termination to the board. PC Tail contacts are available for MIL-DTL-38999 Series I and III cylindrical connectors and also for ARINC 404 and ARINC 600 rectangular connectors. The following page shows the available PC Tail contact part numbers for Subminiature Cylindricals. See the Rectangular Section of this catalog for information on twinax contacts for use in ARINC Rectangular connectors along with compatible cable terminations. Consult Amphenol, Sidney, NY for further information on the applicable tooling for these contacts.

TYPICAL ELECTRICAL PERFORMANCE

Size 8, 12 & 16 PC Tail Coax Contacts

Contact Resistance:

Center @ 1 Amp, 55 millivolts max. voltage drop @ 25°C

Outer @ 1 Amp, 55 millivolts max. voltage drop @ 25°C

Operating Frequency: 0–500 MHz

Dielectric Withstanding Voltage:

Center to Outer 500 VAC Rms @ Sea Level

Insulation Resistance

1,000 megohms minimum @ 25°C

TYPICAL ELECTRICAL PERFORMANCE

Size 8, 10 & 12 PC Tail Twinax Contacts

Contact Resistance:

Center @ 1 Amp, 55 millivolts max. voltage drop @ 25°C

Intermediate @ 1 Amp, 55 millivolts max. voltage drop @ 25°C

Outer @ 1 Amp, 55 millivolts max. voltage drop @ 25°C

Operating Frequency: 0–20 MHz

Dielectric Withstanding Voltage:

Center to Intermediate 500 VAC Rms @ Sea Level

Intermediate to Outer 500 VAC Rms @ Sea Level

Insulation Resistance

1,000 megohms minimum @ 25°C

TYPICAL ELECTRICAL PERFORMANCE

Size 8 PC Tail Triax Contacts

Contact Resistance:

Center @ 1 Amp, 55 millivolts max. voltage drop @ 25°C

Intermediate @ 1 Amp, 55 millivolts max. voltage drop @ 25°C

Outer @ 1 Amp, 55 millivolts max. voltage drop @ 25°C

Operating Frequency: 0–500 MHz

Dielectric Withstanding Voltage:

Center to Intermediate 500 VAC Rms @ Sea Level

Intermediate to Outer 500 VAC Rms @ Sea Level

Insulation Resistance

1,000 megohms minimum @ 25°C

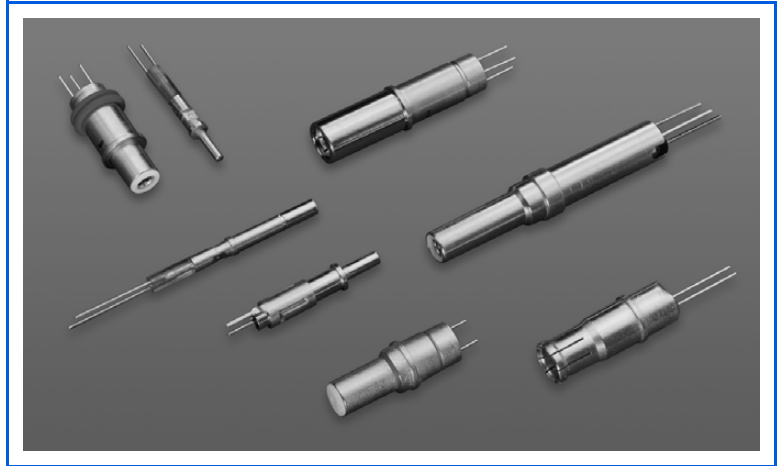

PC Tail Coax and Twinax Contacts for Attachment to Printed Circuit Boards

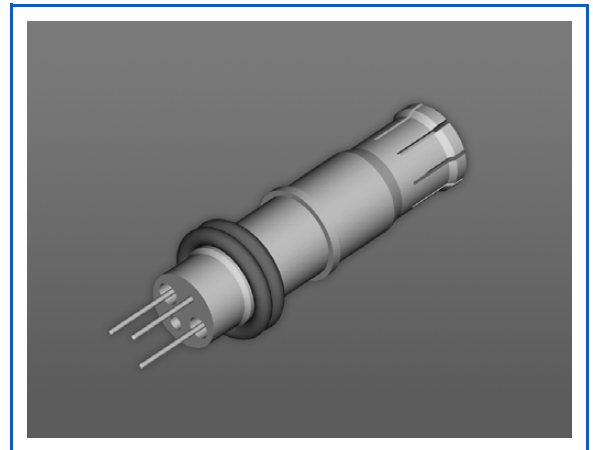

Size 8, PC Tail Twinax Socket Contact for use in D38999 Connectors

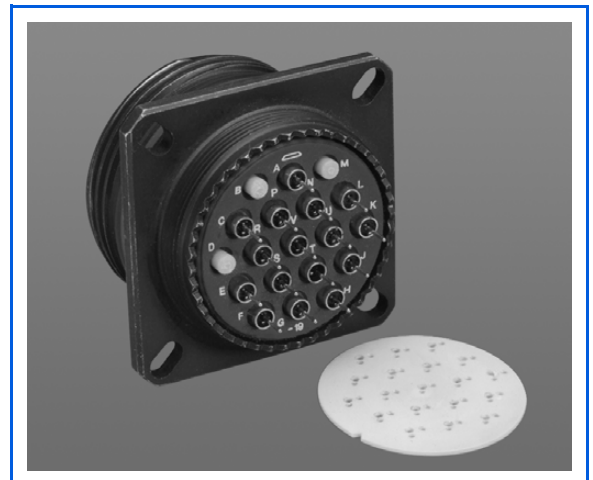

D38999 Connector with PC Tail Coax Contacts, Sealing Plugs in unused contact cavities and PC Tail Alignment Disc

Coax, Twinax & Triax PC Tail Contacts for Subminiature Cylindricals

application data, cont.

PC TAIL COAX, TWINAX, AND TRIAX CONTACTS FOR USE IN D38999 SERIES I & III CONNECTORS					
Size	PC Tail Coax Contact Part Number	PC Tail Twinax Contact Part Number	PC Tail Triax Contact Part Number	Tails*	Comments
8 Pin**	21-33733-1			PCB 2 tails	
12 Pin	21-33686-5			PCB 2 tails	
16 Pin	21-33856-15			PCB 2 tails	
16 Pin	21-33856-25			PCB 90 degree, 2 tails	
16 Pin	21-33634-15			PCB 1 tail	Outer body grounded to shell
16 Socket	21-33611-1			PCB 1 tail	Outer body grounded to shell
16 Socket	21-33857-35			PCB 2 tails	
8 Pin		21-33967-15		PCB 3 tails	M39029/90/91 Interface
8 Pin		21-33967-45		PCB 3 tails	
8 Pin		21-33967-55		PCB 3 tails	
8 Pin		21-33967-65		PCB 3 tails	
8 Pin		21-33967-85		PCB 3 tails	
8 Socket		21-33921-15		PCB 3 tails	
8 Socket		21-33921-25		PCB 3 tails	
8 Socket		21-33921-35		PCB 3 tails	
8 Socket		21-33921-45		PCB 3 tails	
8 Pin		P-209550		PCB 3 tails	
8 Pin		P-209532-1		PCB 9 tails	
8 Pin		P-209532-2		PCB 9 tails	
8 Socket		DB-109002		PCB 2 tails	
8 Socket		21-33919-15		PCB 2 tails	
8 Socket		21-33919-25		PCB 2 tails	
10 Pin**		21-33844-2		PCB 2 tails	
12 Pin**		21-33633-1		PCB 4 tails	JN1104 Interface
12 Pin**		21-33633-2		PCB 4 tails	
12 Pin**		21-33633-3		PCB 4 tails	
12 Pin**		21-33633-4		PCB 4 tails	
8 Socket			21-33841-1	PCB 2 tails	Outer body grounded to shell

* Contact Amphenol, Sidney, NY for tail configurations and tail diameters.

**Consult Amphenol, Sidney, NY for availability.

NOTE: Contacts can be ordered by part numbers given in chart.

Insert Patterns - Subminiature Cylindricals

Incorporating coax, twinax and triax contacts

The following pages show the most popular insert arrangements within the Subminiature Cylindrical Connector Family. See page 6 for Subminiature Connector descriptions and for reference to detailed connector catalogs. This illustrated listing represents the most readily available patterns within the Subminiature Series. If you require other arrangements than what are shown here, consult Amphenol for further availability. In most cases, unless otherwise stated, size 8 and size 12 cavities can be filled with either coax, twinax, triax or power contacts.

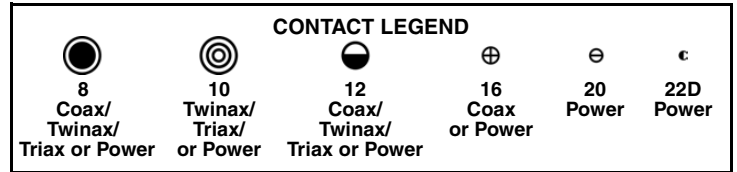

front face of pin inserts illustrated

Insert Arrangement	9-5	10-2	11-2	12-3	13-3	12-4	13-4	14-4	15-4	
Available in Connector Series	TV	SJT	LJT, TV	JT	LJT	JT, SJT	LJT, TV	JT	LJT	
Service Rating	Grounded		I		II		I		I	
Number of Contact	1	2		3		4		4		
Contact Size	8 Twinax	16		16		16		12		
Insert Arrangement	14-5	15-5	14-15	15-15	14-68	15-68	14-97	15-97	16-6	17-6
Available in Connector Series	JT, SJT	LJT, TV	JT, SJT	LJT, TV	JT	LJT	JT, SJT	LJT, TV	JT, SJT	LJT, TV
Service Rating	II		I		I		I		I	
Number of Contact	5		14	1	8		8	4	6	
Contact Size	16		20	16	16		20	16	12	
Insert Arrangement	16-8	17-8	16-13	17-13	16-99	17-99	17-2	17-22	17-22	17-22
Available in Connector Series	JT, SJT	LJT, TV	JT, SJT	LJT	JT, SJT	LJT, TV	LJT	TV	LJT	TV
Service Rating	II		I		I		M		Coax	
Number of Contact	8		13		21	2	38	1	2	2
Contact Size	16		16		20	16	22D	8	12	8
Insert Arrangement	17-25	18-11	19-11	18-28	19-28	18-30	19-30	19-31	19-31	19-31
Available in Connector Series	LJT	JT, SJT	LJT, TV	JT	LJT	JT	LJT	TV	TV	TV
Service Rating	M		II	I		I		M		
Number of Contact	22	2	11	26	2	29	1	2	1	12
Contact Size	22D	8	16	20	16	20	16	8	12	22D

Insert Patterns - Subminiature Cylindricals

Incorporating coax, twinax and triax contacts

CONTACT LEGEND					
8 Coax/ Twinax/ Triax or Power	10 Twinax/ Triax/ or Power	12 Coax/ Twinax/ Triax or Power	16 Coax or Power	20 Power	22D Power

front face of pin inserts illustrated

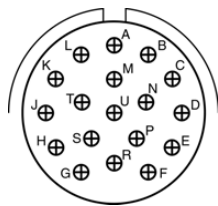

Insert Arrangement	18-68	19-68
Available in Connector Series	JT	LJT
Service Rating	I	
Number of Contact	18	
Contact Size	16	

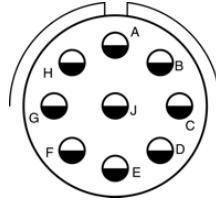

Insert Arrangement	18-96
Available in Connector Series	JT
Service Rating	I
Number of Contact	9
Contact Size	12

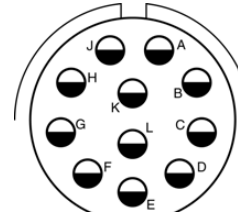

Insert Arrangement	20-11	21-11
Available in Connector Series	JT, SJT	LJT, TV
Service Rating	I	
Number of Contact	11	
Contact Size	12	

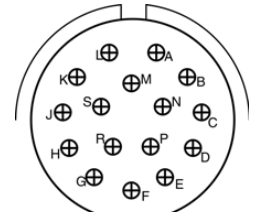

Insert Arrangement	20-16	21-16
Available in Connector Series	JT, SJT	LJT, TV
Service Rating	II	
Number of Contact	16	
Contact Size	16	

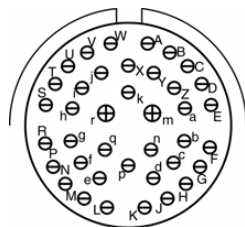

Insert Arrangement	20-39	21-39
Available in Connector Series	JT, SJT	LJT, TV
Service Rating	I	
Number of Contact	37	2
Contact Size	20	16

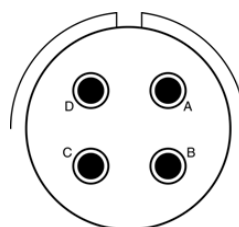

Insert Arrangement	20-75	21-75
Available in Connector Series	SJT	LJT, TV
Service Rating	M	
Number of Contact	4	
Contact Size	8	

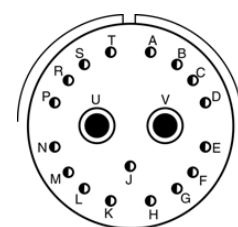

Insert Arrangement	20-79	21-79
Available in Connector Series	SJT	LJT
Service Rating	II	
Number of Contact	17	
Contact Size	22D	

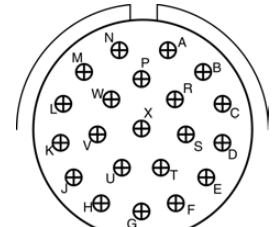

Insert Arrangement	22-21	23-21
Available in Connector Series	JT, SJT	LJT, TV
Service Rating	II	
Number of Contact	21	
Contact Size	16	

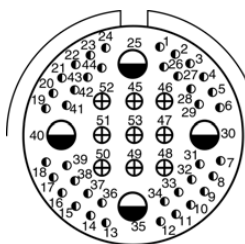

Insert Arrangement	23-54		
Available in Connector Series	TV		
Service Rating	M		
Number of Contact	40	9	4
Contact Size	22D	16	12

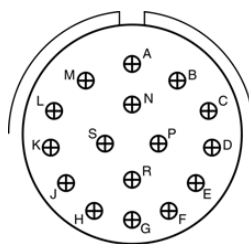

Insert Arrangement	23-97
Available in Connector Series	LJT
Service Rating	II
Number of Contact	16
Contact Size	16

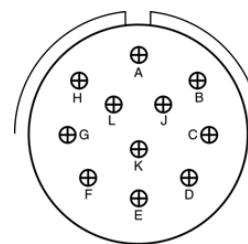

Insert Arrangement	23-99
Available in Connector Series	LJT
Service Rating	II
Number of Contact	11
Contact Size	16

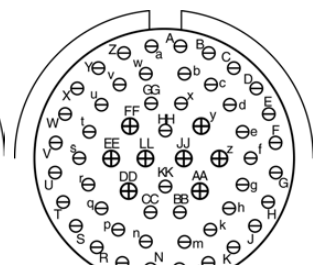

Insert Arrangement	24-4	25-4
Available in Connector Series	JT, SJT	LJT, TV
Service Rating	I	
Number of Contact	48	8
Contact Size	20	16

Insert Patterns - Subminiature Cylindricals

Incorporating coax, twinax and triax contacts

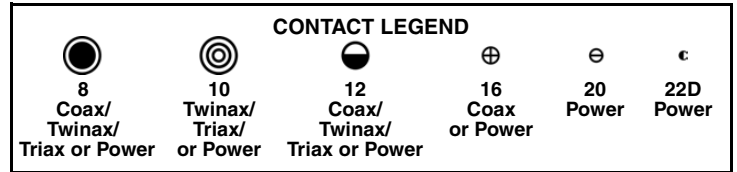

front face of pin inserts illustrated

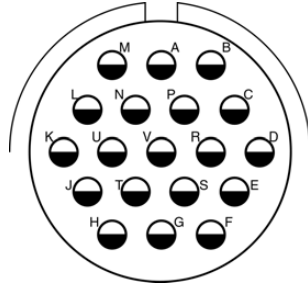

Insert Arrangement	24-19	25-19
Available in Connector Series	JT, SJT	LJT, TV
Service Rating	I	
Number of Contact	19	
Contact Size	12	

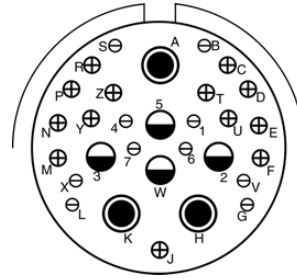

Insert Arrangement	24-20	25-20*
Available in Connector Series	SJT	LJT, TV
Service Rating	N	
Number of Contact	10 13	3 4
Contact Size	20 16	8 12

(Locations U and Y - Dedicated to Fiber Optics)

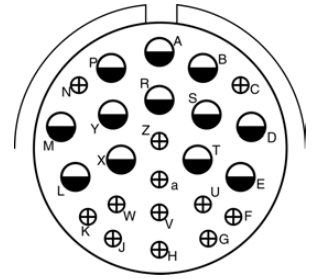

Insert Arrangement	24-24	25-24
Available in Connector Series	JT, SJT	LJT, TV
Service Rating	I	
Number of Contact	12	12
Contact Size	16	12

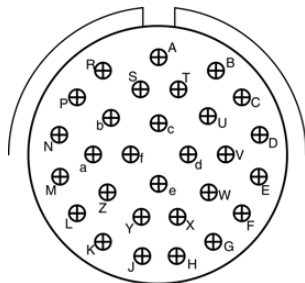

Insert Arrangement	24-29	25-29
Available in Connector Series	JT, SJT	LJT, TV
Service Rating	I	
Number of Contact	29	
Contact Size	16	

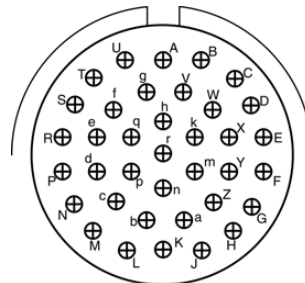

Insert Arrangement	24-37	25-37
Available in Connector Series	JT, SJT	LJT, TV
Service Rating	I	
Number of Contact	37	
Contact Size	16	

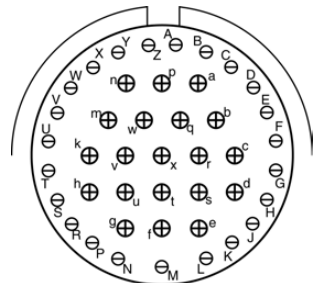

Insert Arrangement	24-43	25-43
Available in Connector Series	JT, SJT	LJT, TV
Service Rating	I	
Number of Contact	23	20
Contact Size	20	16

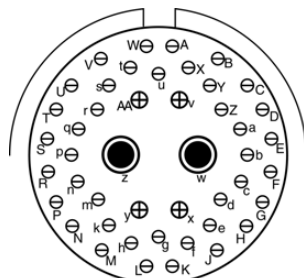

Insert Arrangement	24-46	25-46
Available in Connector Series	SJT	LJT, TV
Service Rating	I	
Number of Contact	40	4 2
Contact Size	20 16	8

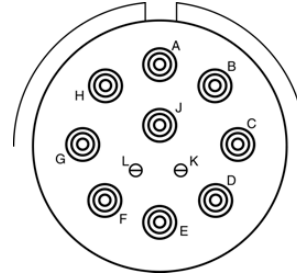

Insert Arrangement	25-11*
Available in Connector Series	LJT, TV
Service Rating	N
Number of Contact	2 9
Contact Size	20 10

* For use in MIL-STD-1760 applications with MIL-DTL-38999 Series III.

Miniature Cylindrical Connector Overview

Amphenol® Miniature Connectors, a widely used, medium sized connector series for military and industrial applications, can incorporate shielded coax contacts. The Miniature family is built around MIL-C-26482 specifications, with Mil-approved and proprietary styles offered. Normal operating voltage for Miniature cylindricals with power only contacts is up to 1,000 VAC (RMS) at sea level.

Miniature Cylindricals offer these features for contact termination flexibility:

- Several insert arrangements that can incorporate:
 - Size 8 & 12 Crimp Coax contacts for Crimp type
 - Size 8 & 12 Solder Coax contacts for Solder type
- Wide selection of connector shell styles and sizes
- Standard power contact options within the various connector styles include: solder type, crimp front release, crimp rear release
- Coax contacts are designed to the same high performance standards as power contacts. Coax and power contacts may be intermixed with no degradation of connector reliability.
- No mis-mating or cross-plugging with insert rotation and key-way polarization.



Miniature Cylindrical MIL-C-26482, Series 1 Connectors

Amphenol® Miniature Cylindrical MIL-C-26482 Series 1* Connector Family:

See Catalog 12-070 for complete information on these styles.

PT, SP, MS/PT

MIL-C-26482, Series 1/Proprietary

Solder Type

- Basis for popular miniature family
- Bayonet coupling, solder contact termination
- MS approved designs meet MIL-C-26482 Series 1, Service Classes E, F and P

PT-CE, SP-CE

Proprietary

Crimp Type, 1-piece insert/grommet assembly

- Bayonet coupling, crimp front release removable contact termination
- Special design feature of a voidless one-piece insert and grommet assembly offering continuous dielectric separation between contacts

PT-SE, SP-SE, MS/PT-SE

MIL-C-26482, Series 1/Proprietary

Crimp Type

- Bayonet coupling, crimp front release removable contact termination
- MS approved designs meet MIL-C-26482 Series 1 with MIL-C-39029 contacts

PC, PC-SE, PC-CE

Proprietary

Solder & Crimp Types

- PC style: Double stub thread coupling, solder contact termination, single key polarization
- PC-SE, PC-CE: Threaded coupling, crimp front release removable contacts

GENERAL ORDERING INFORMATION

Amphenol Miniature Cylindricals are normally supplied with a full complement of power contacts, separately packaged. Coax contacts are ordered by part number as referenced in the part number charts on the following pages of this catalog, and are substituted for the power contacts at the time of the cable or equipment assembly. If the application is for coax only, the connector may be ordered *less contacts* and no power contacts will be supplied. Installation instructions for the coax contacts for Miniature Connectors are provided in Amphenol documents as follows: L-633 for solder type; L-613 for SE type; L-660 for CE type

HOW TO ORDER:

- A. Select the coax contacts designed for the cable being used from the applicable charts in this catalog for each Miniature type (solder, SE or CE).
- B. Select a connector insert from those shown on pages 28 and 29 which will accommodate the quantity and size of coaxial contacts needed plus any power contacts required. Note: Size 8S and 12S contacts are used with connector inserts through shell size 18 only. For larger connector shell sizes, use size 8L contacts.
- C. Determine the Miniature Cylindrical type, shell style, finish, service class and insert rotation required for your application, using Amphenol Catalog 12-070. (Catalog is on-line at www.amphenol-aerospace.com)
- D. Consult Amphenol, Sidney NY with the pertinent cable, contact, insert arrangement and connector style choices for complete connector part number.

* Amphenol also offers Miniature Cylindrical Connectors, MIL-C-26482 Series 2 which are bayonet coupling with crimp rear releaseable and rear insertable contacts. (Ask for Catalog 12-071) Currently these connectors are not offered with shielded contacts, however, consult Amphenol, Sidney NY for any future availability.

Coaxial Contacts for Miniature Cylindricals

general description

Amphenol® Coaxial Contacts designed for use in Miniature Cylindrical Connectors offer the same durability advantages and design benefits for reliable interconnection as the Amphenol coax contacts used in high performance D38999 connectors. A variety of military and commercial shielded cables are accommodated within the miniature cylindrical series. Amphenol supplies coax contacts for solder, crimp SE and crimp CE connector styles.

Other features of the coax for miniature cylindricals include:

- Miniature coax design has an outside nut within the assembly for fast, reliable assembly of contact to cable.
- All types feature solder style inner contacts and crimp style outer contacts for reliable cable termination
- Miniature coax crimp type contacts are designed for use in Miniature crimp series connectors
- Miniature coax solder type contacts are designed for use in Miniature solder series connectors. These come pre-installed into the solder connector.

TYPICAL MINIATURE CRIMP COAX SOCKET CONTACT has crimp socket outer contact with a solder pin inner contact

TYPICAL MINIATURE CRIMP COAX PIN CONTACT has crimp pin outer contact with a solder socket inner contact

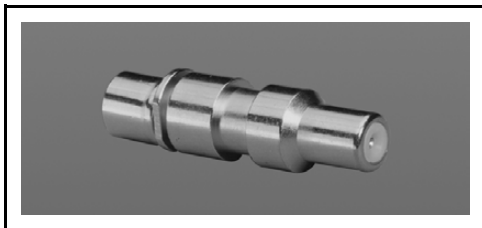
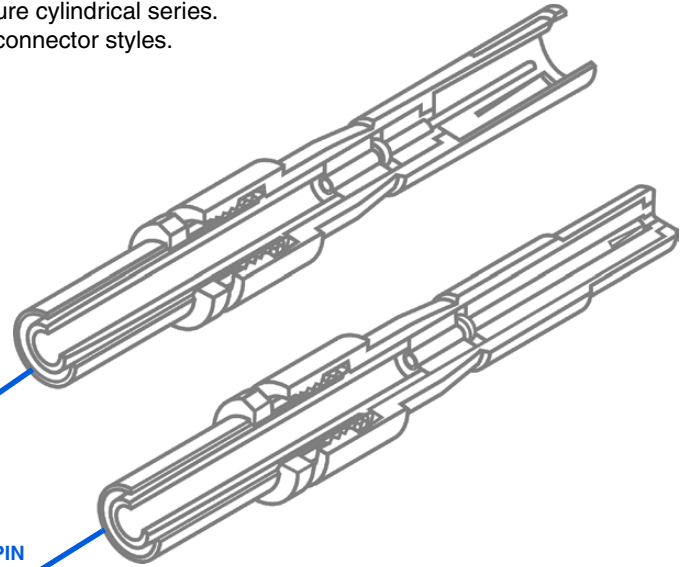

Solder Coax Contact
for use in Miniature Solder Type Connectors

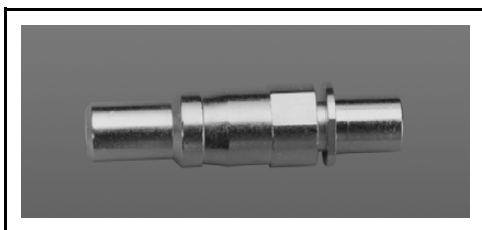

Pin Crimp Coax Contact
for use in Miniature Crimp SE Type Connectors

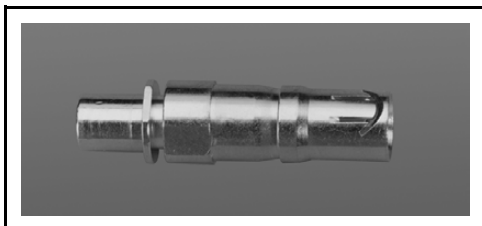

Socket Crimp Coax Contact
for use in Miniature Crimp SE Type Connectors

TYPICAL ELECTRICAL PERFORMANCE Size 8 and 12 Coax Contacts

Contact Resistance:

Center @ 1 Amp, 170 millivolts max. voltage drop @ 25°C

Outer @ 12 Amps, 150 millivolts max. voltage drop @ 25°C

Dielectric Withstanding Voltage:

Size 8: 1,300 VAC Rms @ sea level

Size 12: 1,000 VAC Rms @ sea level

Size 8 & 12: 250 VAC Rms @ 50,000 ft.

Insulation Resistance

5,000 megohms minimum @ 25°C

Typical VSWR for size 8 & 12 PT-SE Types II & III only:

1.2 + .12F (GHz) up to 10 GHz

EXPLANATION OF TYPE CLASSIFICATIONS:

PT-SE Type I is moisture seal design with internal O-ring.

PT-SE Type II is 50 ohm impedance matched version. Contacts terminated to other than 50 ohm cables are therefore not matched.

PT-SE Type III is 50 ohm contact, non-serviceable after assembly

Solder and CE Types are non-impedance matched contacts.

CONTACT FINISHES:

Suffix Finish

1	0.00020 min. silver over copper flash
2	0.00005 min. gold (Knoop hardness 130-200) over silver
3	0.00010 min. gold (Knoop hardness 130-200) over silver
4	0.00010 min. gold (Knoop hardness 130-200) over copper
5	0.00005 min. gold (Knoop hardness 130-200) over nickel
E	0.00005 min. gold (Knoop hardness 90 max.) over copper
F	0.00005 min. gold (Knoop hardness 130-200) over copper
H	0.00010 min. gold (Knoop hardness 130-200) over copper

Coaxial Contacts for Miniature Cylindricals

solder (MIL-C-26482 Series 1 type) - application data

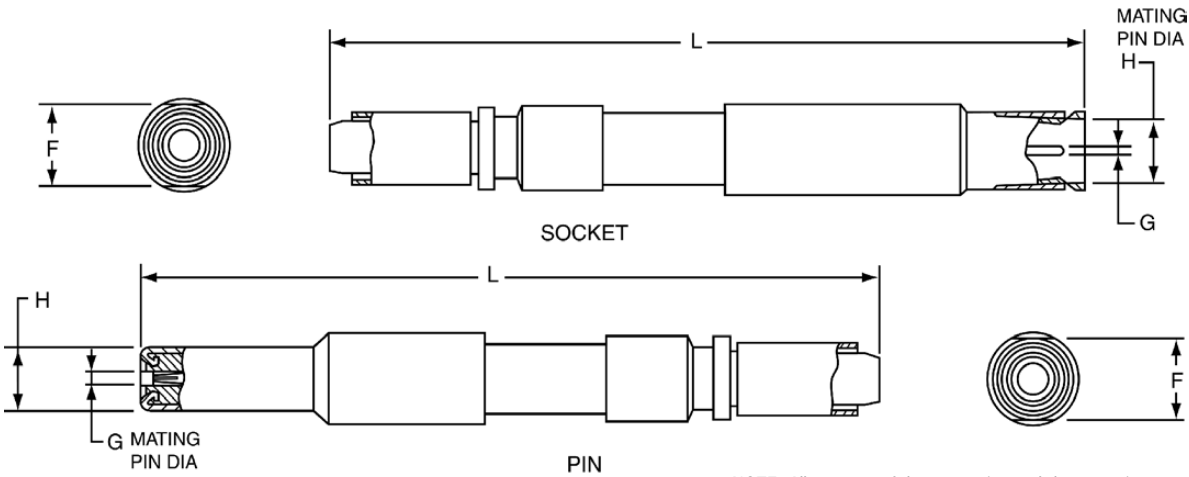

NOTE: All contacts of the same size and the same inner and outer contact diameters (G & H) will mate with each other.

SOLDER COAX CONTACTS												
For use in Miniature Solder Type Connectors: PT, SP, MS/PT and PC Styles												
Cable	Contact Part Number		Contact Size	Dimensional Data (See Drawings above)					Crimp Ferrule Tools			Retainer Nut Wrench
	Pin	Socket		G Dia.	H Dia. ±0.001	F Across Flats ±0.004	L Length Ref.		MIL-T-22910/7-1 Tool Use with Die Part Number	MIL-C-22520/5-01 Tool Use with Die Part Number	MIL-C-22520/10-01 Tool Use with Die Part Number	
							Pin	Socket				
RG-58C/U, RG-141A/U, RG-303/U	21-33020-2	21-33019-2	8S	0.040 ± 0.001	0.219	0.280	1.114	1.115	M22910/7-15 (B)	M22520/5-05 (B) M22520/5-41 (B)	M22520/10-07 (B)	11-8676-2
RG-59B/U, RG-62A/U, RG-62B/U, RG-210/U	21-33020-1	21-33019-1	8L	0.040 ± 0.001	0.219	0.280	1.176	1.177	M22910/7-18 (B)	M22520/5-45 (B)		11-8676-3
	21-33020-3	21-33019-3	8S	0.040 ± 0.001	0.219	0.280	1.114	1.115				
RG-142B/U, Times M151115	21-33020-7*	21-33019-7*	8S	0.040 ± 0.001	0.219	0.280	1.114	1.115	M22910/7-16 (B)	M22520/5-43 (B)		11-8676-2
RG-161/U, RG-174A/U, RG-179B/U, RG-187A/U, RG-188A/U, RG-316/U	21-33020-32*	21-33019-32*	12S	0.0300 ± 0.0005	0.140	0.172	1.092	1.093	M22910/7-12 (B)	M22520/5-03 (A) M22520/5-08 (A) M22520/5-35 (B)	M22520/10-05 (A)	11-8676-1
RG-178B/U	21-33020-4	21-33019-4*	8S	0.040 ± 0.001	0.219	0.280	1.114	1.115	M22910/7-11 (B)	M22520/5-03 (B) M22520/5-33 (B)	M22520/10-05 (B)	11-8676-2
RG-196A/U	21-33020-31†	21-33061-31†	12S	0.0300 ± 0.0005	0.140	0.172	1.092	1.093	M22910/7-11 (B)	M22520/5-03 (B) M22520/5-33 (B)	M22520/10-05 (B)	11-8676-1
RG-180B/U, RG-195A/U, Raychem 5022D1312-9	21-33020-5*	21-33019-5*	8S	0.040 ± 0.001	0.219	0.280	1.114	1.115	M22910/7-15 (B)	M22520/5-05 (B) M22520/5-41 (B)	M22520/10-07 (B)	11-8676-2
Raychem 5021D1331-9	21-33020-6*	21-33019-6*	8S	0.040 ± 0.001	0.219	0.280	1.114	1.115	M22910/7-15 (B)	M22520/5-05 (B) M22520/5-41 (B)	M22520/10-07 (B)	11-8676-2
Thermatics 2929-29	21-33020-33	21-33061-33	12S	0.0200 ± 0.0005	0.140	0.172	1.092	1.093	M22910/7-13 (B)	M22520/5-37 (B)		11-8676-1

NOTE: Contacts can be ordered by part numbers given in chart

NOTE: Size 8S and 12S contacts are used with connector inserts through shell size 18 only. For larger connector shell sizes, use size 8L contacts.

CONTACT FINISH: For all contacts in this series feature 0.000050 minimum gold (Knoop hardness 130-200).

* Consult Amphenol, Sidney NY for availability

CRIMPING TOOLS: Italicized letters in parenthesis that follow positioner part numbers indicate applicable die closure. Commercial equivalents with the same die closure dimension may be used.

† 21-33020-31 and 21-33061-31 only mate with each other

Coaxial Contacts for Miniature Cylindricals

crimp SE (MIL-C-26482 Series 1 type) - application data

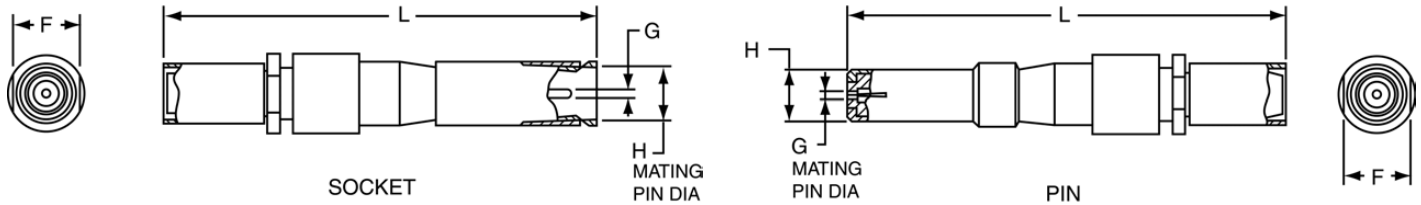

NOTE: All contacts of the same size and the same inner and outer contact diameters (G & H) will mate with each other.

SE CRIMP COAX CONTACTS																			
For use in Miniature Crimp Type Connectors: PT-SE, SP-SE, MS/PT-SE and PC-SE Styles																			
Cable	Contact Part Number		Contact Size	Type (See Pg. 23)	Finish on Mating Parts (See Pg. 23)	Dimensional Data (See Drawings above)				Crimp Ferrule Tools			Retainer Nut Wrench	Installation Tools					
						G Dia.	H Dia. ±0.001	F Across Flats ±0.004	L Length Ref.		MIL-T-22910/7-1 Tool Use with Die Part Number	MIL-C-22520/5-01 Tool Use with Die Part Number		MIL-C-22520/10-0 Tool Use with Die Part Number	Insertion	Removal			
	Pin	Socket							Pin	Socket									
RG-55B/U, RG-142A/U, RG-142B/U, RG-223/U	21-33012-21	21-33011-21	8	I	2	0.0355 ±0.0010	0.218	0.280	1.156	1.144	M22910/7-17 (B)	M22520/5-05 (A) M22520/5-19 (B)	M22520/10-07 (A)	11-8676-2	11-8369-5	11-7880-8			
	21-33012-25	21-33011-25	8	II	4										11-8660-5	11-8154-1			
	21-33138-21(*) 21-33138-25(*)	21-33137-21(*) 21-33137-25(*)	8	I II	**														
RG-58C/U, RG-141A/U, RG-303/U	21-33012-22	21-33011-22	8	I	2	0.0355 ±0.0010	0.218	0.280	1.156	1.144	M22910/7-15 (B)	M22520/5-05 (B) M22520/5-41 (B)	M22520/10-07 (B)	11-8676-2	11-8369-4	11-7880-8			
	21-33012-26	21-33011-26	8	II	4										11-8660-4	11-8154-1			
	21-33138-22(*) 21-33138-26(*)	21-33137-22(*) 21-33137-26(*)	8	I II	**														
RG-59B/U, RG-62A/U, RG-62B/U, RG-210/U	21-33012-36	21-33011-36	8	II	2	0.0355 ±0.0010	0.218	0.280	1.156	1.144	M22910/7-18 (B)	M22520/5-45 (B)		11-8676-3	11-8369-5	11-7880-8			
	21-33038-36*	21-33037-36	8	II	4										11-8660-5	11-8154-1			
	21-33138-36(*)	21-33137-36(*)	8	II	**														
RG-140/U, RG-302/U	21-33012-37*	21-33011-37*	8	II	2	0.0355 ±0.0010	0.218	0.280	1.156	1.144	M22910/7-17 (B)	M22520/5-05 (A) M22520/5-19 (B)	M22520/10-07 (A)	11-8676-2	11-8369-5	11-7880-8			
	21-33038-37*	21-33037-37*	8	II	4										11-8660-5	11-8154-1			
	21-33138-37(*)	21-33137-37(*)	8	II	**														
RG-161/U, RG-174A/U, RG-179B/U, RG-187A/U, RG-188A/U, RG-316/U	21-33012-34	21-33011-34	8	I	2	0.0355 ±0.0010	0.218	0.280	1.156	1.144	M22910/7-12 (B)	M22520/5-03 (A) M22520/5-08 (A) M22520/5-35 (B)	M22520/10-05 (A)	11-8676-2		11-7880-8			
	21-33012-30	21-33011-30	8	II	4										11-8154-1				
	21-33038-34 21-33038-30	21-33037-34 21-33037-30	8 8	I II	4														
	21-33138-34(*) 21-33138-30(*)	21-33137-34(*) 21-33137-30(*)	8 8	I II	**														
	21-33012-1 21-33012-4	21-33011-1 21-33011-4	12 12	I II	2	0.0200 ±0.0005	0.128	0.172	1.092	1.072							11-8676-1		11-7880-12
	21-33038-1* 21-33038-4	21-33037-1* 21-33037-4*	12 12	I II	4													11-8154-2	
21-33138-1(*) 21-33138-4(*)	21-33137-1(*) 21-33137-4(*)	12 12	I II	**															
RG-178B/U, RG-196A/U	21-33012-35	21-33011-35	8	I	2	0.0355 ±0.0010	0.218	0.280	1.156	1.144	M22910/7-11 (B)	M22520/5-03 (B) M22520/5-33 (B)	M22520/10-05 (A)				11-8676-2		11-7880-8
	21-33038-35	21-33037-35	8	I	4													11-8154-1	
	21-33138-35(*)	21-33137-35(*)	8	I	**														
	21-33012-3* 21-33012-5	21-33011-3* 21-33011-5	12 12	I II	2	0.0200 ±0.0005	0.128	0.172	1.092	1.072							11-8676-1	11-8369-1	11-7880-12
	21-33038-3* 21-33038-5	21-33037-3* 21-33037-5*	12 12	I II	4													11-8154-2	
	21-33138-3(*) 21-33138-5(*)	21-33137-3(*) 21-33137-5(*)	12 12	I II	**														

NOTE: Contacts can be ordered by part numbers given in chart

** See finish options for SE crimp Miniature contacts listed on page 23. Replace the parenthesis of the contact part number with the finish suffix number. However, you should consult Amphenol, Sidney, NY regarding the availability of all finish choices for each part number.

* Consult Amphenol, Sidney NY for availability

CRIMPING TOOLS: Italicized letters in parenthesis that follow positioner part numbers indicate applicable die closure. Commercial equivalents with the same die closure dimension may be used.

CHART CONTINUES ON NEXT PAGE

Coaxial Contacts for Miniature Cylindricals

crimp SE (MIL-C-26482 Series 1 type) - application data, cont.

NOTE: All contacts of the same size and the same inner and outer contact diameters (G & H) will mate with each other.

SE CRIMP COAX CONTACTS																
For use in Miniature Crimp Type Connectors: PT-SE, SP-SE, MS/PT-SE and PC-SE Styles																
Cable	Contact Part Number		Contact Size	Type (See Pg. 23)	Finish on Mating Parts (See Pg. 23)	Dimensional Data (See Drawings pg. 25)				Crimp Ferrule Tools			Retainer Nut Wrench	Installation Tools		
						G Dia.	H Dia. ±0.001	F Across Flats ±0.004	L Length Ref.		MIL-T-22910/7-1 Tool Use with Die Part Number	MIL-C-22520/5-01 Tool Use with Die Part Number		MIL-C-22520/10-0 Tool Use with Die Part Number	Insertion	Removal
	Pin	Socket														
RG-180B/U, RG-195A/U	21-33012-24	21-33011-24	8	I	2	0.0355 ± 0.0010	0.218	0.280	1.156	1.144	M22520/7-15 (B)	M22520/5-05 (B) M22520/5-41 (B)	M22520/10-07 (B)	11-8676-2	11-8369-4 11-8660-4	11-7880-8 11-8154-1
	21-33038-24	21-33037-24	8	I	4											
	21-33038-46*	21-33037-46*	8	II	4											
Raychem 9527E1118, RG-180B/U, RG-195A/U	21-33138-24(*)	21-33137-24(*)	8	I	**	0.0200 ± 0.0005	0.128		0.899	0.879	Daniels GS200 Tool with G2P330 or M22520/31-01 Tool with Positioner M22520/31-02		11-8676-12	11-7880-12 11-8154-2		
	21-33138-46(*)	21-33137-46(*)	8	II	**											
RG-188 or RG-316 Double Braid	21-33012-6*	21-33011-6*	12	I	2	0.0200 ± 0.0005	0.128	0.172	1.092	1.072	M22910/7-13 (B)	M22520/5-37 (B)		11-8676-1	11-8369-2 11-8660-2	11-7880-12 11-8154-2
	21-33038-6*	21-33037-6*	12	I	4											
	21-33038-7*	21-33037-7*	12	II	4											
Thermax 50C-25A-DS-1	21-33138-6(*)	21-33137-6(*)	12	I	**	0.0355 ± 0.0010	0.128	0.280	1.156	1.144			11-8676-2	11-8369-4 11-8660-4	11-7880-8 11-8154-1	
	21-33138-7(*)	21-33137-7(*)	12	II	**											
	21-33012-44	21-33011-44	8	II	2											
RG-195 Double Braid	21-33038-44*	21-33037-44*	8	II	4	0.0355 ± 0.0010	0.128	0.280	1.156	1.144	M22910/7-16 (B)	M22520/5-43 (B)		11-8676-2	11-8369-4 11-8660-4	11-7880-8 11-8154-1
	21-33138-44(*)	21-33137-44(*)	8	II	**											
	21-33012-28	21-33011-28	8	I	2											
RG-122/U, Raychem 5022E5111	21-33038-28*	21-33037-28*	8	I	4	0.0355 ± 0.0010	0.128	0.280	1.156	1.144	M22910/7-16 (B)	M22520/5-43 (B)		11-8676-2	11-8369-4 11-8660-4	11-7880-8 11-8154-1
	21-33138-28(*)	21-33137-28(*)	8	I	**											
	21-33012-23	21-33011-23	8	I	2											
Raychem 9530D5314	21-33012-27	21-33011-27	8	II	2	0.0355 ± 0.0010	0.218	0.280	1.156	1.144	M22520/7-15 (B)	M22520/5-05 (B) M22520/5-41 (B)	M22520/10-07 (B)	11-8676-2	11-8369-4 11-8660-4	11-7880-8 11-8154-1
	21-33038-23*	21-33037-23*	8	I	4											
	21-33038-27	21-33037-27	8	II	4											
Raychem 9527A1317	21-33138-23(*)	21-33137-23(*)	8	I	**	0.0355 ± 0.0010	0.218	0.280	1.156	1.144	M22520/7-15 (B)	M22520/5-05 (B) M22520/5-41 (B)	M22520/10-07 (B)	11-8676-2	11-8369-4 11-8660-4	11-7880-8 11-8154-1
	21-33138-27(*)	21-33137-27(*)	8	II	**											
	21-33012-31	21-33011-31	8	I	2											
Raychem 7527A1318	21-33038-31	21-33037-31	8	I	4	0.0355 ± 0.0010	0.218	0.280	1.156	1.144	M22910/7-15 (B)	M22520/5-05 (B) M22520/5-41 (B)	M22520/10-07 (B)	11-8676-2	11-8369-4 11-8660-4	11-7880-8 11-8154-1
	21-33138-31(*)	21-33137-31(*)	8	I	**											
	21-33012-39	21-33011-39	8	II	2											
Westrex 199-49-1, Tensolite 30850/87T-1	21-33038-39*	21-33037-39*	8	II	4	0.0200 ± 0.0005	0.128	0.172	1.092	1.072	M22910/7-11 (B)	M22520/5-03 (B) M22520/5-33 (B)	M22520/10-05 (B)	11-8676-1	11-8369-1 11-8660-1	11-7880-12 11-8154-2
	21-33138-39(*)	21-33137-39(*)	8	II	**											
	21-33012-40*	21-33011-40*	8	II	2											
Raychem 7527A1318	21-33038-40*	21-33037-40*	8	II	4	0.0355 ± 0.0010	0.218	0.280	1.156	1.144	M22910/7-12 (B)	M22520/5-03 (A) M22520/5-08 (A) M22520/5-35 (B)	M22520/10-05 (A)	11-8676-2	11-8369-2 11-8660-2	11-7880-8 11-8154-1
	21-33138-40*	21-33137-40(*)	8	II	**											
	21-33012-43	21-33011-43	12	II	2											
Westrex 199-49-1, Tensolite 30850/87T-1	21-33038-43	21-33037-43	12	II	4	0.0200 ± 0.0005	0.128	0.172	1.092	1.072	M22910/7-11 (B)	M22520/5-03 (B) M22520/5-33 (B)	M22520/10-05 (B)	11-8676-1	11-8369-1 11-8660-1	11-7880-12 11-8154-2
	21-33138-43(*)	21-33137-43(*)	12	II	**											

NOTE: Contacts can be ordered by part numbers given in chart

** See finish options for SE crimp Miniature contacts listed on page 23. Replace the parenthesis of the contact part number with the finish suffix number. However, you should consult Amphenol, Sidney, NY regarding the availability of all finish choices for each part number.

* Consult Amphenol, Sidney NY for availability

CRIMPING TOOLS: Italicized letters in parenthesis that follow positioner part numbers indicate applicable die closure. Commercial equivalents with the same die closure dimension may be used.

Coaxial Contacts for Miniature Cylindricals

crimp CE (MIL-C-26482 Series 1 type) - application data

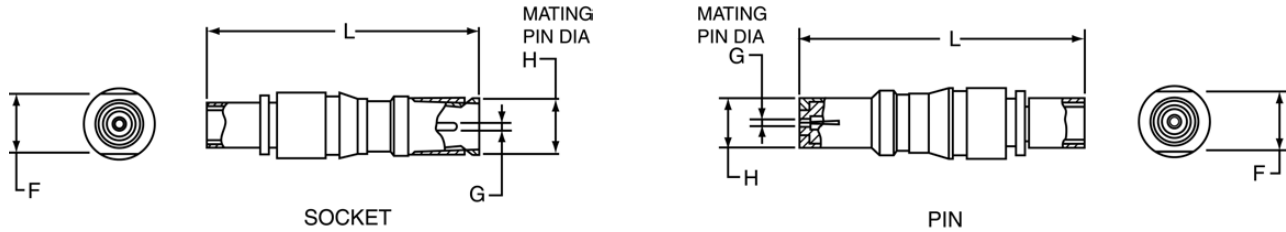

NOTE: All contacts of the same size and the same inner and outer contact diameters (G & H) will mate with each other.

CE CRIMP COAX CONTACTS														
For use in Miniature Crimp Type Connectors: PT-CE, SP-CE and PC-CE Styles														
Cable	Contact Part Number		Contact Size	Dimensional Data (See Drawings above)					Crimp Ferrule Tools			Retainer Nut Wrench	Installation Tools	
				G Dia. ± 0.001	H Dia. ± 0.001	F Across Flats ± 0.004	L Length Ref.		MIL-T-22910/7-1 Tool Use with Die Part Number	MIL-C-22520/5-01 Tool Use with Die Part Number	MIL-C-22520/10-01 Tool Use with Die Part Number		Insertion	Removal
	Pin	Socket												
RG-58C/U, RG-141A/U, RG-303/U	21-33024-1	21-33023-1	8	0.040	0.219	0.280	1.239	1.285	M22910/7-15 (B)	M22520/5-01 (B) M22520/5-41 (B)	M22520/10-07 (B)	11-8676-2	11-8369-4 11-8660-4	11-7310
RG-178B/U, RG-196A/U	21-33024-2	21-33023-2	8	0.040	0.219	0.280	1.039	1.085	M22910/7-11 (B)	M22520/5-03 (B) M22520/5-33 (B)	M22520/10-05 (B)	11-8676-2	11-8369-1 11-8660-1	11-7310

NOTE: Contacts can be ordered by part numbers given in chart

* Consult Amphenol, Sidney NY for availability

CONTACT FINISH: for all contacts in this series feature 0.000050 minimum gold (Knoop hardness 130-200).

CRIMPING TOOLS: Italicized letters in parenthesis that follow positioner part numbers indicate applicable die closure. Commercial equivalents with the same die closure dimension may be used.

Insert Patterns - Miniature Cylindricals

Incorporating coax contacts, solder and crimp

The following pages show the most popular insert arrangements within the Miniature Cylindrical Connector Family. See page 22 for Miniature Connector descriptions and for reference to detailed connector catalogs. This illustrated listing represents the most readily available patterns within the Miniature Series. If you require other arrangements than what are shown here, consult Amphenol for further availability. In most cases, unless otherwise stated, size 8 is available in coax only and size 12 cavities can be filled with either coax or power contacts. Solder types come pre-installed in connectors. Consult Amphenol, Sidney NY for any variations needed.

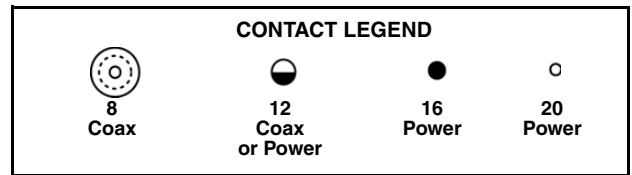

front face of pin inserts illustrated

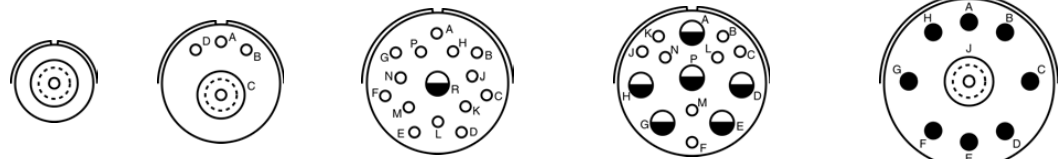

Insert Arrangement	10-70	14-71	16-70	16-76	18-71
Available in Connector Series	Solder	Solder	Solder	Solder Flashover 1,500 VAC (RMS)	SE Crimp
Service Rating	Coax	I	N/A	8 6	Coax, II
Number of Contact	1	1 3	1 14	8 6	1 8
Contact Size	8	8 16	12 20	20 12	8 16

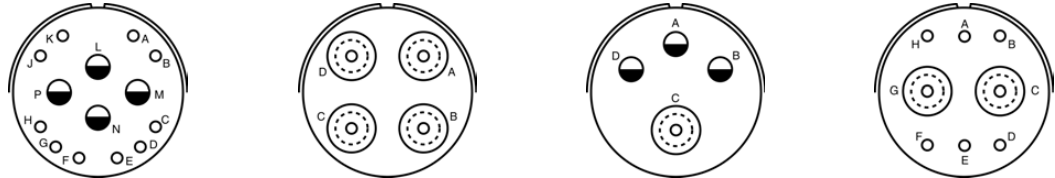

Insert Arrangement	18-72	18-75	18-76	18-80
Available in Connector Series	Solder	Solder	Solder	Solder
Service Rating	N/A	Coax	II	Coax, I
Number of Contact	4 10	4	1 3	2 6
Contact Size	12 20	8	8 12	8 20

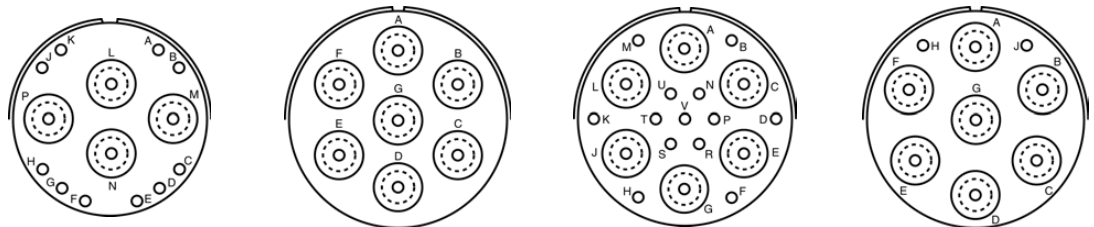

Insert Arrangement	20-70	22-7	22-70	22-71
Available in Connector Series	Solder, CE Crimp	Solder, SE Crimp	Solder	Solder, CE Crimp
Service Rating	Coax	Coax	I, Coax	I, Coax
Number of Contact	4 10	7	6 13	7 2
Contact Size	8 20	8	8 20	8 20

Insert Patterns - Miniature Cylindricals

Incorporating coax contacts, solder and crimp

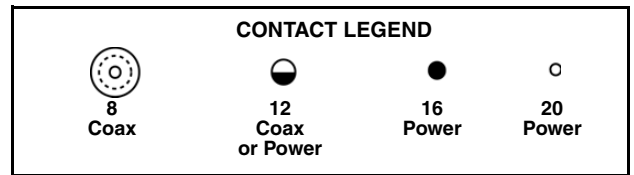

front face of pin inserts illustrated

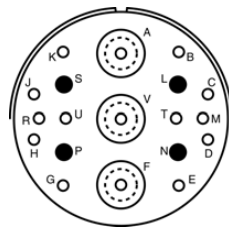

22-72

Solder

N/A

3 4 12

8 16 20

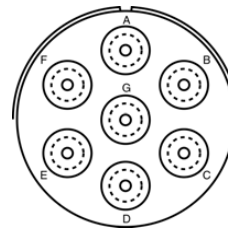

22-78

Solder

I

7

8

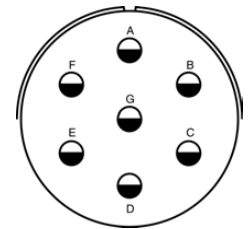

22-96

SE Crimp

II

7

12

Insert Arrangement
Available in Connector Series
Service Rating
Number of Contact
Contact Size

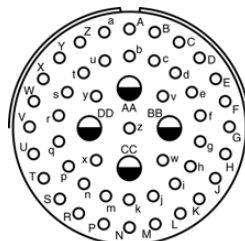

24-51

SE Crimp

I

4 47

12 20

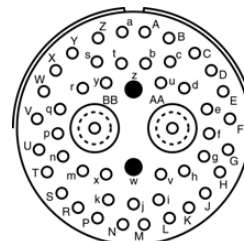

24-71

Solder

N/A

2 2 45

8 16 20

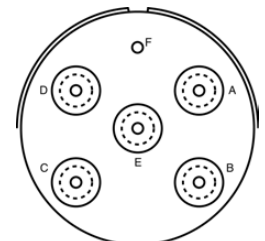

24-79

Solder

Coax

5 1

8 20

Insert Arrangement
Available in Connector Series
Service Rating
Number of Contact
Contact Size

Standard MIL-C-5015, Heavy Duty MIL-C-22992 Cylindrical Connectors Overview

Amphenol's medium to heavy weight cylindricals include the MS/Standard MIL-C-5015 series and the heaviest weight, largest size cylindrical is the Heavy Duty MIL-C-22992 series. These time-tested cylindricals have been used for several years. They are dependable general duty and environmentally resistant connectors for military and industrial applications.

Shielded coax contacts, although more popularly used in 38999 types and 26482 types, can be incorporated into some arrangements of the 5015 and 22992 type cylindricals. Shielded coaxial contacts within these series are considered MS modifications to the MIL-spec connector and the coax contacts are pre-installed in the connector. Normal operating voltage with power contacts only is up to 3000 VAC (RMS) at sea level for MIL-C-5015 cylindricals. The Heavy Duty types are designed for high current capacity and have current ratings (with power contacts only) of up to 200 amps.

Standard and Heavy Duty Cylindricals offer these features for contact termination flexibility:

- Insert arrangements that can incorporate:
 - Size 4, 8 & 12 Crimp Coax contacts, pre-installed in the connector
- Wide selection of connector shell styles and sizes
- Standard power contact options within the various connector styles include: solder type, crimp front release, crimp rear release
- Coax contacts are designed to the same high performance standards as power contacts. Coax and power contacts may be intermixed with no degradation of connector reliability.

Amphenol® MS/Standard Cylindrical MIL-C-5015* Type Connector Family:

See Catalog 12-020 for complete information on these styles.

MS-A, MS-C, MS-E, MS-F, MS-R

- Produced in strict accordance with MIL-C-5015
- Threaded coupling, solder or crimp rear insertion contacts (coax available in crimp type only)
- Class A, Solid Shell - intended for general connector usage
- Class C, Pressurized - for use on pressurized bulkheads or pressure barriers
- Class E/F, Environmental Resisting - ideally suited for installation where condensation, vibration and rapid changes in pressure or temperature are considerations
- Class R, Lightweight Environmental Resisting - shorter in length and lighter in weight than Class E

GENERAL ORDERING INFORMATION

Amphenol MS/Standard MIL-C-5015 type and Heavy Duty MIL-C-22992 type cylindricals are normally supplied with a full complement of power contacts, separately packaged. Coax contacts are ordered by part number as referenced in the part number charts on the following pages of this catalog, and are substituted for the power contacts at the time of the cable or equipment assembly. Coax contacts are pre-installed in these series. Installation instructions for the coax contacts for these series are provided in Amphenol document L-650.

HOW TO ORDER:

- Select the coax contacts designed for the cable being used from the chart on page 32 of this catalog.
- Select a connector insert from those shown on page 33 which will accommodate the quantity and size of coaxial contacts needed plus any power contacts required.
- Determine the MS/Standard or Heavy Duty Series style desired. (See features of each series referenced above). The catalog referenced for each series will guide you in determining shell style, finish, service class and insert rotation required for your application.
Catalog 12-020 - MS/Standard MIL-C-5015 Type Connectors (catalog is on-line at www.amphenol-aerospace.com)
Catalog 12-052 - MIL-C-22992 QWLD Connectors (catalog is on-line at www.amphenol-aerospace.com)
Catalog 12-053 - QWL Connectors (catalog is currently not on-line; consult Amphenol, Sidney NY for hardcopy)
- Consult Amphenol, Sidney, NY with the pertinent cable, contact, insert arrangement and connector style choices for complete connector part number.

* Amphenol also offers the following other MIL-C-5015 Cylindrical Connectors which are threaded coupling (consult Amphenol, Sidney NY for availability of shielded contacts in any of these series):

- Amphenol®/Matrix® MIL-C-5015 with crimp rear releaseable and rear insertable contacts. (Ask for Catalog 12-026)
- Amphenol® MIL-C-5015 Modifications (Ask for Catalog 12-021)
- Amphenol® GT Series with reverse bayonet coupling (Ask for Catalog 12-024)
- Amphenol® AC Threaded and AC-B Bayonet Series (Ask for Catalog 12-025)



MS/Standard MIL-C-5015 Type Connectors



Heavy Duty QWLD,
MIL-C-22992 Connectors

Amphenol® Heavy Duty Cylindrical MIL-C-22992 Connector Family:

QWLD

- Designed for most power and control circuits
 - Military MIL-C-22992 qualified versions and proprietary equivalents
- See Catalog 12-052 for complete information on these styles.

QWL

- A more compact heavy duty design for industrial power and control applications

See Catalog 12-053 for complete information on these styles.

Coaxial Contacts for Standard MIL-C-5015, Heavy Duty MIL-C-22992 Cylindricals

general description

Amphenol® Coaxial Contacts can be incorporated into MS/Standard MIL-C-5015 Type Cylindrical Connectors and Heavy Duty MIL-C-22992 Connectors. They offer the same durability advantages and design benefits for reliable interconnection as the Amphenol coax contacts used in high performance D38999 connectors. A variety of military and commercial shielded cables are accommodated within these cylindrical series.

Other features of the coax contacts available for MS/Standard and Heavy Duty cylindricals include:

- Several insert arrangements that can incorporate:
 - Size 4, 8 and 12 coax contacts
- Advanced shielding wire technology in a rugged military connector
- Single connector with multiple coaxial connection eliminates cross-mating
- Positive contact captivation - especially important in these series with its much higher coupling/uncoupling force
- Older shielded cable type availability

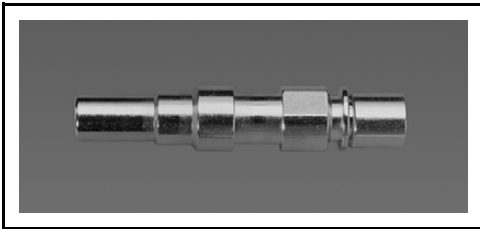

Coax Contact, Pin
for use in MS/Standard MIL-C-5015 and
Heavy Duty MIL-C-22992 Connectors

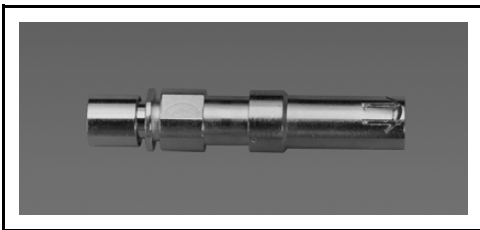

Coax Contact, Socket
for use in MS/Standard MIL-C-5015 and
Heavy Duty MIL-C-22992 Connectors

TYPICAL ELECTRICAL PERFORMANCE

Size 4, 8 & 12 Contacts

Contact Resistance:

Center @ 1 Amp, 170 millivolts max. voltage drop @ 25°C

Outer @ 12 Amps, 150 millivolts max. voltage drop @ 25°C

Dielectric Withstanding Voltage:

Size 4 & 8: 1,300 VAC Rms @ sea level

Size 12: 1,000 VAC Rms @ sea level

Size 4, 8 & 12: 250 VAC Rms @ 50,000 ft.

Insulation Resistance

5,000 megohms minimum @ 25°C

All contacts in these series are non-impedance matched contacts.

Part numbers 21-33063-XX() and 21-33064-XX() are moisture seal design (internal O-ring).

CONTACT FINISHES:

Suffix	Finish
1	0.00020 min. silver over copper flash
2	0.00005 min. gold (Knoop hardness 130-200) over silver
3	0.00010 min. gold (Knoop hardness 130-200) over silver
4	0.00010 min. gold (Knoop hardness 130-200) over copper
5	0.00005 min. gold (Knoop hardness 130-200) over nickel
E	0.00005 min. gold (Knoop hardness 90 max.) over copper
F	0.00005 min. gold (Knoop hardness 130-200) over copper
H	0.00010 min. gold (Knoop hardness 130-200) over copper

Coaxial Contacts for Standard MIL-C-5015, Heavy Duty MIL-C-22992 Cylindricals

application data

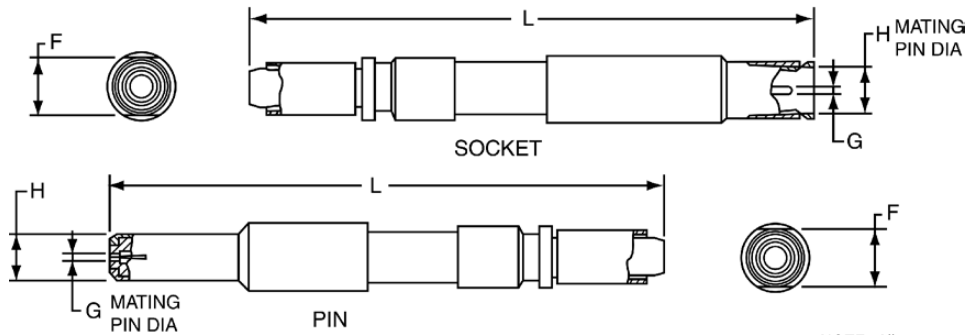

NOTE: All contacts of the same size and the same inner and outer contact diameters (G & H) will mate with each other.

COAX CONTACTS													
For use in MS/Standard MIL-C-5015 Type and Heavy Duty MIL-C-22992 Type Connectors													
Cable	Contact Part Number		Contact Size	Finish on Mating Parts (See Pg. 31)	Dimensional Data (See Drawings above)					Crimp Ferrule Tools			Retainer Nut Wrench
	Pin	Socket			G Dia.	H Dia. ± 0.001	F Across Flats ± 0.004	L Length Ref.		MIL-T-22910/7-1 Tool Use with Die Part Number	MIL-C-22520/5-01 Tool Use with Die Part Number	MIL-C-22520/10-01 Tool Use with Die Part Number	
								Pin	Socket				
RG-58C/U, RG-141A/U, RG-303/U	21-33014-1	21-33013-1	8	5	0.0355 ± 0.0010	0.218	0.280	1.481	1.511	M22910/7-15 (B)	M22520/5-05 (B) M22520/5-41 (B)	M22520/10-07 (B)	11-8676-2
	21-33034-2	21-33033-2	8	1									
	21-33048-2	21-33047-2	8	†									
	21-33016-5	21-33015-5	8	3									
	21-33130-2(*)	21-33129-2(*)	8	**									
RG-59B/U, RG-62A/U, RG-62B/U, RG-210/U	21-33014-5	21-33013-5	8	5	0.0355 ± 0.0010	0.218	0.280	1.481	1.511	M22910/7-18 (B)	M22520/5-45 (B)		11-8676-3
	21-33016-2	21-33015-2	8	3									
	21-33034-5	21-33033-5*	8	1									
	21-33130-5(*)	21-33129-5(*)	8	**									
	21-33064-21(*)	21-33063-21(*)	8	**									
	21-33060-10(*)	21-33059-10(*)	4	**	0.0400 ± 0.0010	0.344	0.375	1.669	1.605				11-8676-4
RG-161/U, RG-174A/U, RG-179B/U, RG-187A/U, RG-188A/U, RG-316/U	21-33014-3	21-33013-3	8	5	0.0355 ± 0.0010	0.218	0.280	1.481	1.511	M22910/7-12 (B)	M22520/5-03 (A) M22520/5-08 (A) M22520/5-35 (B)	M22520/10-05 (A)	11-8676-2
	21-33016-1	21-33015-1	8	3									
	21-33034-3	21-33033-3	8	1									
	21-33130-3(*)	21-33129-3(*)	8	**									
	21-33064-20(*)	21-33063-20(*)	8	**									
	21-33014-21	21-33013-21	12	5	0.0200 ± 0.0005	0.128	0.172						11-8676-1
21-33034-1	21-33033-1	12	1										
21-33048-1	21-33047-1	12	**										
21-33130-1(*)	21-33129-1(*)	12	**										
RG-178B/U, RG-196A/U	21-33014-22*	21-33013-22*	12	5	0.0200 ± 0.0005	0.128	0.172	1.481	1.511	M22910/7-11 (B)	M22520/5-03 (B) M22520/5-33 (B)	M22520/10-05 (B)	11-8676-1
RG-180B/U, RG-195A/U	21-33014-6	21-33013-6	8	5	0.355 ± 0.0010	0.218	0.280	1.481	1.511	M22910/7-15 (B)	M22520/5-05 (B) M22520/5-41 (B)	M22520/10-07 (B)	11-8676-2
	21-33034-6*	21-33033-6*	8	1									
	21-33048-3	21-33047-3	8	**									
	21-33130-6(*)	21-33129-6(*)	8	**									
RG-212/U	21-33060-11(*)	21-33059-11(*)	4	**	0.0625 ± 0.0010	0.344	0.375	1.669	1.605	M22910/7-14 (A)	M22520/5-39 (A)		11-8676-4
RG-140/U, RG-302/U	21-33014-8	21-33013-8	8	5	0.0355 ± 0.0010	0.218	0.280	1.481	1.511	M22910/7-17 (B)	M22520/5-05 (A) M22520/5-19 (B)	M22520/10-07 (A)	11-8676-2
	21-33034-8	21-33033-8	8	1									
	21-33130-8(*)	21-33129-8(*)	8	**									
RG-55B/U, RG-142A/U, RG-142B/U, RG-223/U	21-33014-4	21-33013-4	8	5	0.0355 ± 0.0010	0.218	0.280	1.481	1.511	M22910/7-17 (B)	M22520/5-05 (A) M22520/5-19 (B)	M22520/10-07 (A)	11-8676-2
	21-33034-4	21-33033-4	8	1									
	21-33130-4(*)	21-33129-4(*)	8	**									
	21-33060-12(*)	21-33059-12(*)	4	**	0.0625 ± 0.0010	0.344	0.375	1.669	1.605				11-8676-4

NOTE: Contacts can be ordered by part numbers given in chart

** See finish options for MS/Standard and Heavy Duty contacts listed on page 31. Replace the parenthesis of the contact part number with the finish suffix number. However, you should consult Amphenol, Sidney, NY regarding the availability of all finish choices for each part number.

* Consult Amphenol, Sidney NY for availability

CRIMPING TOOLS: Italicized letters in parenthesis that follow positioner part numbers indicate applicable die closure. Commercial equivalents with the same die closure dimension may be used.

† 21-33047-X and 21-33048-X are supplied with E (soft gold) finish on mating socket parts, and F (hard gold) finish on mating pin parts.

Insert Patterns - Standard MIL-C-5015, Heavy Duty MIL-C-22992 Cylindricals

Incorporating coax contacts

The following shows the most popular insert arrangements within the Cylindrical Connector families of MS/Standard MIL-C-5015 and the Heavy Duty QWLD/Heavy Duty QWL series of MIL-C-22992. See page 30 for these series connector descriptions and for reference to detailed connector catalogs. This illustrated listing represents the most readily available patterns within these series. If you require other arrangements than what are shown here, consult Amphenol for further availability. MS/Standard connectors have over 200 insert pattern arrangements available, and within these patterns any size 4, 8 or 12 contact cavities can be incorporated with coax contacts. However, you need to consult Amphenol, Sidney NY for availability and ordering information. All coax contacts in the Standard and Heavy Duty series come pre-installed in connectors.

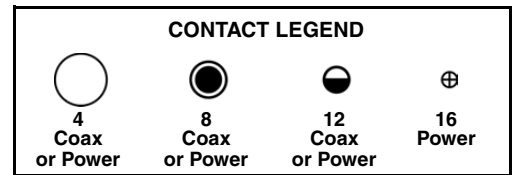

front face of pin inserts illustrated

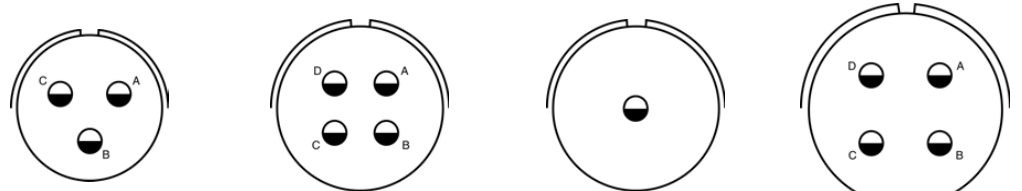

Insert Arrangement	16-10	18-10	18-16	20-4
Available in Connector Series	MS/Standard, QWLD, QWL	MS/Standard, QWLD, QWL	MS/Standard, QWLD, QWL	MS/Standard, QWLD, QWL
Service Rating	A	A	C	D
Number of Contact	3	4	1	4
Contact Size	12	12	12	12

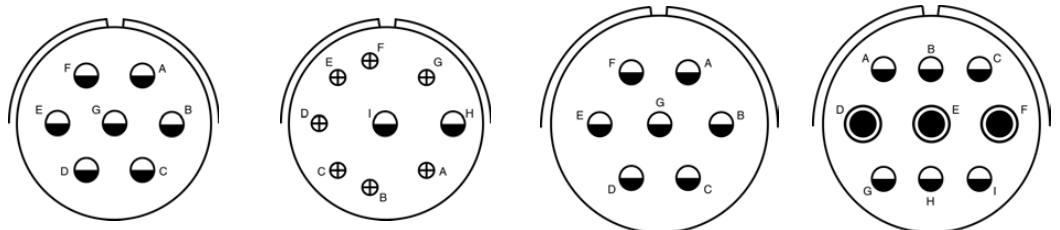

Insert Arrangement	20-15	20-16	24-2	24-11
Available in Connector Series	MS/Standard, QWLD, QWL	MS/Standard, QWLD, QWL	MS/Standard, QWLD, QWL	MS/Standard, QWLD, QWL
Service Rating	A	A	D	A
Number of Contact	7	2 7	7	3 6
Contact Size	12	12 16	12	8 12

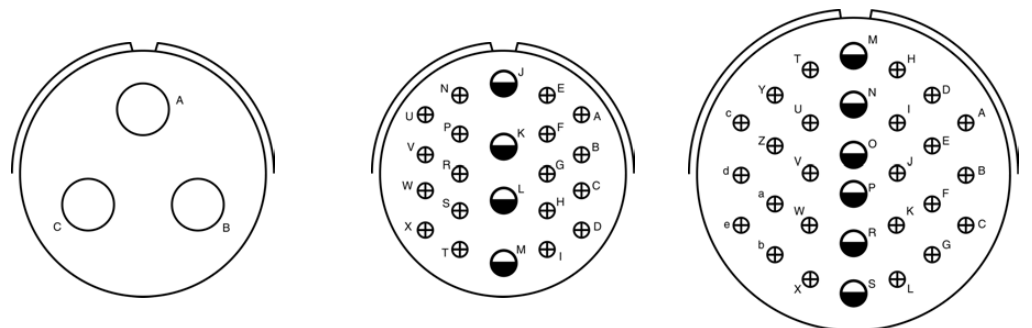

Insert Arrangement	28-6	28-11	32-8
Available in Connector Series	MS/Standard, QWLD, QWL	MS/Standard, QWLD, QWL	MS/Standard, QWLD, QWL
Service Rating	D	A	A
Number of Contact	3	4 18	6 24
Contact Size	4	12 16	12 16

Rectangular Connector Overview

Printed Circuit Board, ARINC Rack & Panel Connectors

Amphenol provides an impressive array of Rectangular Interconnection products to meet the needs of high density systems such as opto-electrical backplanes used in many applications that include: medical equipment, IC chip testers, telecommunications, military and commercial aviation, military ground vehicles, GPS systems, space and industrial applications.

Low Mating Force Rectangular Connectors with Brush Contacts

See Catalog 12-035 for complete information on this series.

- Designed to provide reliable interconnection means with printed circuit boards
- Qualified to MIL-C-55302
- Incorporates Brush Contacts - multiple points of contacts and very low insertion force achieved through the intermeshing of 0.007 inch diameter wires
- Excellent durability - over 20,000 cycles of mating/unmating without performance degradation
- High density available - 2, 3 and 4 row contact arrangements with 10 to 100 contacts per row
- Four body styles allow for flexibility: applications for parallel boards, perpendicular boards, wire to board, end to end boards, card extenders
- Hybrids are available - combinations of signal contacts with coax, power or fiber optics

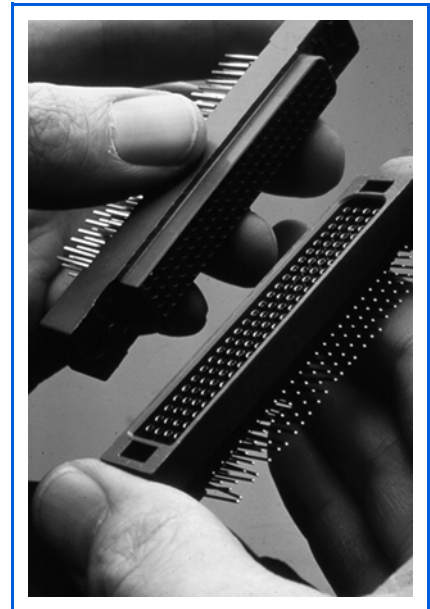

Low Mating Force Connectors with signal Brush contacts can also incorporate power or coax contacts.

ARINC 600 Rack and Panel Rectangular Connectors

See Amphenol Canada Publication SL-379, ARINC 600 Rack and Panel Connectors for complete information.

- The ARINC 600 is the successor to the ARINC 404 for many of the new avionics designs and offers lower mating force contacts, increased contact count and a front release, floating keying system
- ARINC 600 Connectors are a recognized standard rack and panel connector for aircraft applications with both environmental and non-environmental versions available
- Up to 800 size 22 contact positions in one connector
- Contact options: standard contacts are power/signal crimp rear release; also available with wire wrap front release socket contacts, or PC tail front release socket contacts, or coax and concentric twinax contacts

GENERAL ORDERING INFORMATION

Amphenol Rectangular Connectors are normally ordered with signal or brush contacts. To order connectors with shielded contacts:

- A. Select the coax contacts designed for the cable being used from the chart on page 35 of this catalog.
- B. Select the Rectangular Series desired. (See features of series referenced here.) The catalog referenced for each series will guide you in determining the connector style and arrangement required for your application. (catalogs are on-line at www.amphenol-aerospace.com)
Catalog 12-035 - Low Mating Force Rectangular Connectors
Catalog SL-379 - ARINC 600 Rack and Panel Connectors
- C. Consult Amphenol, Sidney, NY with the pertinent cable, contact criteria, and connector style desired for complete connector part number.

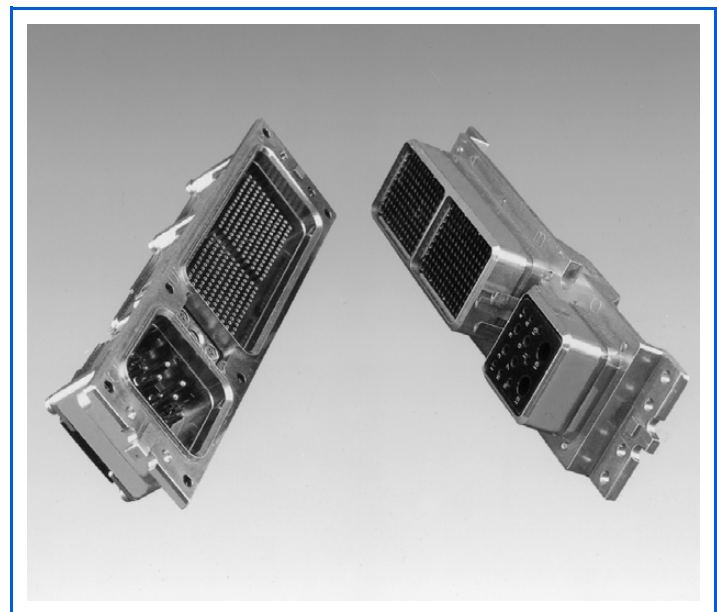

ARINC 600 Rack and Panel Connectors are high density connectors that can incorporate coax or twinax contacts.

NOTE: Amphenol also offers LRM Surface Mount Rectangular Connectors, a modular design connector with ultra high density of signal brush contacts. (Ask for publications L-2104, LRM Surface Mount Reference Guide and L-2081, LRM Surface Mount Designer's Guide.) Consult Amphenol, Sidney NY for availability of shielded contacts within LRM connectors.

Coax & Twinax Contacts for Rectangulars

Printed Circuit Board, ARINC Rack & Panel Connectors

Amphenol® Coaxial and Twinax Contacts can be incorporated into Amphenol Rectangular Connectors. Rectangular Connectors offer these features for contact termination flexibility:

- Low Mating Force PCB connectors can incorporate:
 - size 16 and size 12 Coax contacts
- ARINC 600 Rack and Panel connectors can incorporate:
 - size 8 Coax contacts
 - size 12 Twinax contacts
- Flexibility of designing in combinations of contact types in one rectangular body

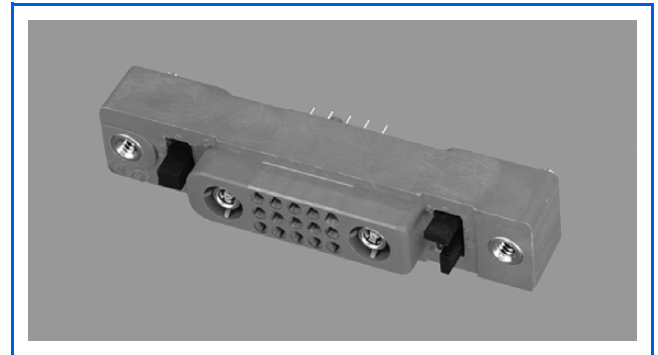

Low Mating Force PCB Connector with combination of signal Brush contacts and Coax contacts

COAX CONTACTS			
For use in Low Mating Force PCB Rectangular Connectors			
Cable	Contact Part Number		Contact Size
	Pin	Socket	
RG-178B/U, RG-196A/U	21-33122-564 (M39029/76-425)	21-33121-564 (M39029/78-433)	16
Haveg 30-00761 30-02024 30-02033 Tensolite 24713/A955KK1 26723/A955KK1	21-33122-562*	21-33121-562*	
Haveg 61-02051	21-33122-561*	21-33121-561*	
RG-174A/U, RG-188A/U, RG-161/U, RG-187A/U, RG-316/U, RG-179B/U, Haveg 8100207, Times (HS-179) AA3248 Teledyne 11299	21-33122-563 (M39029/76-424)	21-33121-563 (M39029/78-432)	
RG-180B/U, RG-195A/U, Raychem 9528A1318	21-33122-541 (M39029/28-409)	21-33121-541 (M39029/27-402)	12
Raychem 5022E5111	21-33122-543*	21-33121-543*	
Raychem 9530A5314	21-33122-544	21-33121-544	
Raychem 9527A1318	21-33122-545	21-33121-545	
Gore GWN1159A	21-33122-547*	21-33121-547*	
RG-178, Gore CXN3403	21-3365-18	21-33729-18	

NOTE: Low Mating Force PCB connectors use the same coax contacts as used in MIL-DTL-38999 Series II Connectors.

* Consult Amphenol, Sidney NY for availability.



Coax Contact, Size 8 for use in ARINC Rack and Panel Connectors

COAX CONTACTS			
For use in Rectangular ARINC 600 Connectors			
Cable	Contact Part Number		Contact Size
	Pin	Socket	
RG-179	21-33676-1	21-33676-5	8
5M2869-001	21-33676-2	21-33676-5	8

TWINAX CONTACTS				
For use in Rectangular ARINC 600 Connectors				
Cable	For PCB Attachment	Contact Part Number		Contact Size
		Pin	Socket	
EPD 32263, 10612, GSC-12-2548-00		21-33631-3	21-33632-3	12
	PCB (3 Tails)	21-33914-25		8 Front Release

Typical Contact Installation Instructions for Coax Contacts

The following is an example of a contact instruction sheet that would be shipped within the package of contacts for a Crimp, Size 12 Coax Contact for use in Subminiature, D38999 connectors. The sheet provides detailed instructions for assembling the component parts and for crimping the contact to coaxial cable, along with the recommended cable and tooling to be used. Installation instructions are included within all contacts for D38999 connectors. For installation instructions for other connector series, there are separate documents (not included in packaging of parts) as follows: L- 633 for Miniature solder types, L-613 for Miniature SE types, L-660 for Miniature CE types, and L-650 for MS/Standard and Heavy Duty types. For any other instructions needed, consult Amphenol, Sidney, NY. Most installation instructions can be found on-line at www.amphenol-aerospace.com (from home page, go to Tech Support, Service Instructions and enter contact part number).

21-33651-11 (PIN)
21-33650-11 (SOCKET)

Contact, Pin and Socket, Coaxial,
 Type LJT-R & TV-R, (MIL-C-38999 Series I & III) Crimp, Size 12
 Installation Instructions

See table on reverse side for coaxial cable recommended and crimp tool information.

- A. 1. Slide outer crimp ferrule over cable outer jacket as shown.
2. Strip cable outer braid as illustrated. Ends must be cut cleanly and at right angles to the axial plane of the cable. The cable must not be deformed while making cuts.
3. Flare outer braid, then strip cable dielectric as shown.
- B. 1. Assemble inner contact assembly over cable center conductor and cable dielectric until inside bore of bushing butts against cable dielectric.
2. Cable center conductor must be visible through the inspection hole in the inner contact wire well.
3. Crimp inner contact wire well using crimp tool listed in table.
- C. 1. Carefully slide outer contact assembly over inner contact assembly and under cable outer braid until inner contact butts against insulator shoulder as illustrated. (Inner contact assembly will snap into the locked position when fully assembled inside the outer contact assembly).
2. Bring outer crimp ferrule forward over cable outer braid as illustrated. (Continue to push the inner contact assembly fully forward while bringing the outer crimp ferrule into position).
3. Crimp outer crimp ferrule using crimp tool listed in table. (.156 Max. over ferrule after crimping). Trim excess braid ahead of crimp ferrule, if necessary.

CONTACT INSERTION INTO CONNECTOR

Using insertion tool (part number M81969/8-09 or M81969/14-04), insert contact assembly into rear connector grommet hole. Contact must be aligned with hole and not inserted at an angle. Push forward until contact is felt to snap into position within insert. Remove tool.

CONTACT REMOVAL FROM CONNECTOR

Position removal tool (part number M81969/8-10 or M81969/14-04) around cable and slide tool down wire until tool tips enter rear grommet and come to a positive stop. Hold tool tip firmly against positive stop on contact, grip wire and simultaneously remove tool, contact and cable.

21-33651-11 (PIN)
21-33650-11 (SOCKET)

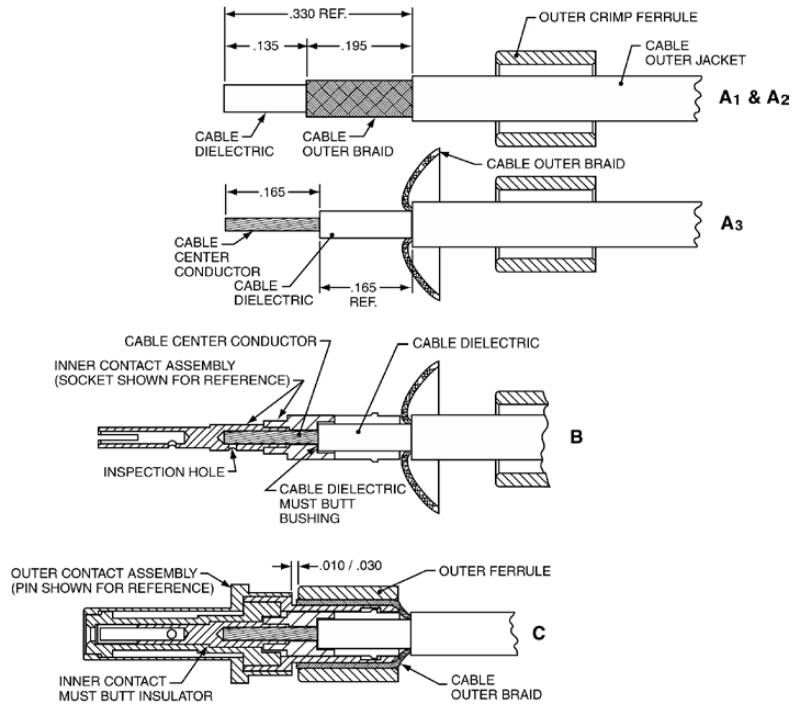

Amphenol Aerospace

AMPHENOL CORPORATION
 Amphenol Aerospace
 40-60 Delaware Avenue
 Sidney, New York 13838-1395

L-2092-C
 October 2001

FSCM77820

Amphenol® Part Number	Description	Coaxial Cable Accommodated	Tools				
			Inner Contact			Outer Contact	
			Crimp Tool	Setting	Positioner (Daniels)	Tool	Positioner
21-33651-11	Matched Impedance* Size 12 Coax Pin	RG316 (M17/113-RG316)	MH992 (Daniels)	5	K1360	M22520/5-01	M22520/5-03 (A) or M22520/5-35 (B)
		RG179 (M17/094-RG179)	MH992 (Daniels)	4	K1360		
21-33650-11	Matched Impedance* Size 12 Coax Socket	RG316 (M17/113-RG316)	MH992 (Daniels)	5	K1360		
		RG179 (M17/094-RG179)	MH992 (Daniels)	4	K1360		

* Matched Impedance applies when contacts are terminated to RG316 cable only.

Additional Contact Styles

Amphenol provides interconnect solutions

Amphenol has today's broadest range of interconnection solutions for military, commercial and industrial applications. As a worldwide Interconnection Product Leader, Amphenol can meet not only connector needs, but also contact needs of all types. In addition to the shielded contacts shown in this publication, many other contact styles are available:

THERMOCOUPLE CONTACTS

Available for MIL-DTL-5015, MIL-C-22992, MIL-C-26482, MIL-C-26500, MIL-DTL-38999, MIL-DTL-83723 and other series connectors. Thermocouples are designed for temperature measuring applications, and are available in both pin and socket configurations in alumel, chromel, iron and constantan materials. Refer to each of the MIL series catalogs.

WIRE WRAP CONTACTS

Available for MIL-C-26482 and MIL-DTL-38999 series connectors. See catalog 12-090 (38999, Series I & II) for part numbers and dimensional data.

PRINTED CIRCUIT BOARD CONTACTS

In addition to the coax, twinax and triax contacts described in this publication, Amphenol has a full range of printed circuit tail contacts for signal and power applications. Available in both solder termination and compliant pin tails, they offer significant savings in system installed costs. Catalog 12-170, Amphenol® Cylindrical Connectors for PCB Applications, provides information on connectors available with PCB contacts which include MIL-DTL-38999, MIL-C-26482 and MIL-C-5015 styles.

FLEX TERMINATION ASSEMBLIES FOR PCB APPLICATION

Flex circuits are available for MIL-DTL-38999, MIL-C-5015 and MIL-C-26482, as well as for special products such as EMI/EMP filter connectors. Flex termination assemblies are provided by the ACT, Advanced Circuit Technology division of Amphenol. Sculptured Flexible Circuits with built-in terminations plug into a printed circuit board and create a self-locking terminal pad which eliminates the need for an additional interconnect to the PCB. See catalog 12-170 and consult Amphenol for further information.

BRUSH CONTACTS

As mentioned in the Rectangular section of this publication, the Amphenol® Low Mating Force and Amphenol® LRM Surface Mount Connectors utilize the Brush contact design. The Brush or B³ contact is an alternative to fork and blade conventional contacts. It provides superior electrical characteristics with multiple strands of high tensile wire that are bundled together. 70% to 90% reduction in mating/unmating forces is achieved over conventional contacts, and the brush contact has proven durability and long contact life. See catalogs 12-035 for Low Mating Force Connectors and L-2081 and L-2104 for LRM Connectors.

FIBER OPTIC TERMINI

Amphenol provides fiber optic termini for multi-channel MIL-DTL-38999 Series III connectors and for Low Mating Force and LRM rectangular connectors. Amphenol MIL-T-29504/4 & /5 qualified fiber optic termination types offer low loss characteristics with high reliability and repeatability. Optical performance is maximized utilizing the unique alignment methods employed in these termination systems. Fiber optic/electrical hybrid combinations provide flexibility. See Amphenol® Fiber Optic Products Catalog, 12-352.

RADSOK SOCKETS

The new RADSOK contact design is a hyperbolic, stamped grid configuration within the socket cylinder. As the male pin is inserted, axial members in the female socket half deflect, imparting high current flow across the connection with minimal voltage loss. The new RADSOK contact design has been incorporated into three of the large industrial families from Amphenol - the GT Series, the P-Lok Series, and 5015 types. The new connector lines are called Amphe-Power® Connectors, reflecting the high power amperage applications they are designed for. Enhanced with RADSOK sockets, these Amphe-Power connectors can now handle up to 150% higher amperages. See Brochure SL-391



GROUND PLANE CONNECTORS

MIL-DTL-38999 type connectors are available with metallic inserts to maintain a common ground plane for all twinax, triax or coax contacts contained in the connector. This photo shows a special hybrid design of a Ground Plane Connector with a standard Mil-spec insert, designed for applications where the twinax contacts are required to be bonded to a common ground plane, but insulated signal or power contacts are also required.



Sculptured Flex Circuits



Fiber Optic Termini

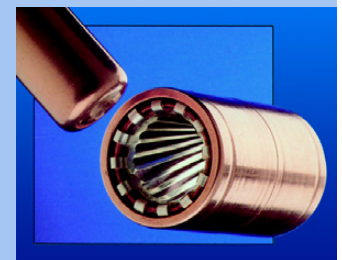

RADSOK Socket Contact

Please visit our websites: www.amphenol-aerospace.com
and www.amphenol-industrial.com
to view catalogs mentioned on this page and others.