

Rundsteckverbinder

C 015

Circular Connectors

C 015



Rundsteckverbinder entspricht EN 17 5000 (DIN 43 563)

Die Rundsteckverbinder der Serie C 015 entsprechen den Anforderungen der EN 175 000. Die Serie ist durch ihre stabile Bauweise und ihre einfache Handhabung gekennzeichnet. Weiterhin ist sie kompatibel mit Steckverbindern nach MIL-C-5015 der Gehäusegröße 14S.

Ihre Hauptanwendungsgebiete sind der Einsatz in Stetig- und Proportionalventilen, sowie in der Meß-, Steuer- und Regeltechnik.

Circular Connector according to EN 17 500 (DIN 43 563)

The circular connector series C 015 corresponds to the technical data according to EN 175 000. Solid construction and easy handling are the specific features. Furthermore, this series is intermatable with connectors according to MIL-C-5015, shell size 14S.

The main fields of application are in the proportional valves, as well as in the measurement, test and control.

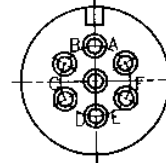
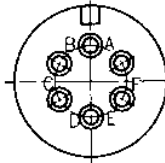
C 015**Technische Daten
Specifications**

Kontaktanordnung nach EN 175 000
Contact arrangement acc. to EN 175 000

Polzahl <i>Number of contacts</i>	6	6 + PE
Bemessungsspannung ¹⁾ <i>Rated insulation voltage</i>	150 V–	
Bemessungs-Stoßspannung ¹⁾ <i>Rated impulse with stand voltage</i>	2500 V	
Verschmutzungsgrad ¹⁾ <i>Pollution degree</i>	3	
Überspannungskategorie ¹⁾ <i>Installation category</i>	3	
Bezugsspannung ²⁾ <i>Voltage rating</i>	60 V– / 75 V–	
Isolationsgruppe ²⁾ <i>Insulation group</i>	C	
Prüfspannung ²⁾ <i>Test voltage</i>	1390 V	
Strombelastbarkeit ³⁾ <i>Current rating</i>	0,5 mm ² , 6 A, +70 °C Umgebungstemperatur / <i>ambient temperature</i> 1,5 mm ² , 9 A, +70 °C Umgebungstemperatur / <i>ambient temperature</i>	
Anschlußart <i>Termination</i>	Kabeldose: crimpen/löten; Gerätestecker: löten, tauchlöten <i>female cable connector: crimp/solder; male receptacle: solder, dip solder</i>	
Anschlußquerschnitt <i>Wire gauge</i>	Kabeldose: 0,14-0,5 mm ² , 0,5-1,5 mm ² ; Gerätestecker: max. 1,5 mm ² <i>female cable connector: 0,14-0,5 mm², 0,5-1,5 mm²; male receptacle: max. 1,5 mm²</i>	
Kontaktoberfläche <i>Contact plating</i>	Ag	
Temperaturbereich <i>Temperature range</i>	-40 °C / +100 °C	
Prüfklasse ⁴⁾ <i>Test class</i>	40 / 100 / 56	
Verriegelung <i>Locking system</i>	schrauben, Anziehdrehmoment 1,5 Nm - 2,0 Nm <i>screw locking, tightening torque 1,5 Nm - 2,0 Nm</i>	
Schutzart <i>Protection class</i>	IP 65	
Durchgangswiderstand <i>Contact resistance</i>	≤ 5 mΩ	
Isolationswiderstand <i>Insulation resistance</i>	≤ 10 ¹⁰ Ω	
Werkstoff Kontaktträger/Gehäuse <i>Material contact insert/back shell</i>	PA 6.6, Brandverhalten / <i>flammability</i> (UL 94): V-0	
Werkstoff Gehäuse/Verriegelungsring <i>Material shell/locking ring</i>	Al	
Steckzyklen <i>Mating cycles</i>	500	
Gesamtsteckkraft <i>Mating force</i>	50 N	
Gesamtziehkraft <i>Withdrawal force</i>	50 N	

¹⁾ Angaben nach / *acc. to* DIN VDE 0110 T 2 / 1.89

²⁾ Angaben nach / *acc. to* VDE 0110 b / 2.79

³⁾ Angaben nach / *acc. to* JEC 512-3

⁴⁾ Angaben nach / *acc. to* DIN JEC 68

C 015
Kabeldose
Female Cable Connector



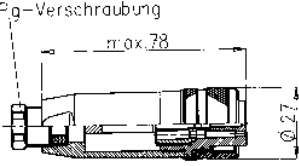

Montageanleitung
Assembling instruction

Beschreibung Description	Maßzeichnung Drawing	Polzahl No. of cont.	Bestellnummer / Part Number		
			Lötanschluß / solder termin. Kontaktfläche / contact plating silber / silver		Crimpanschluß crimp termination
Kabeldose, Kabeldurchmesser: 8-10 mm Female cable connector, cable outlet 8-10 mm.		6 + PE	C 015 30D006 001 1	—	C 015 10D006 001 1
		6 pol.	C 015 30D006 001 2	—	C 015 10D006 001 2
Kabeldose, Kabeldurchmesser: 10-12 mm Female cable connector, cable outlet 10-12 mm.		6 + PE	C 015 30D006 002 1	—	C 015 10D006 002 1
		6 pol.	C 015 30D006 002 2	—	C 015 10D006 002 2

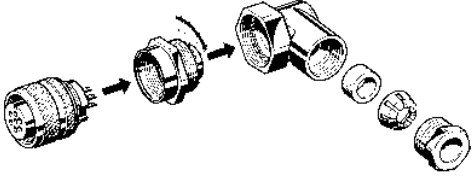
C 015
Wickelsteckverbinder
Angled connector

Montageanleitung und
Maßzeichnung
Mounting instruction and drawing

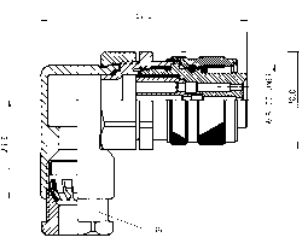
Beschreibung Description	Maßzeichnung Drawing	Polzahl No. of cont.	Bestellnummer / Part Number		
			Lötanschluß / solder termin. Kontaktfläche / contact plating silber / silver		Crimpanschluß crimp termination
Kabeldose, Kabeldurchmesser: 8-10 mm Female cable connector, cable outlet 8-10 mm.		6 + PE	C 015 30 F006 001 1	—	C 015 10 F006 001 1
		6 pol.	C 015 30 F006 001 2	—	C 015 10 F006 001 2
Kabeldose, Kabeldurchmesser: 10-12 mm Female cable connector, cable outlet 10-12 mm.		6 + PE	C 015 30 F006 002 1	—	C 015 10 F006 002 1
		6 pol.	C 015 30 F006 002 2	—	C 015 10 F006 002 2

Verarbeitungswerkzeuge und Crimpkontakte auf Anfrage. / Tools for processing and crimp contacts upon request.

C 015

Gerätestecker Male Receptacle



Mit Flachdichtung
with flat sealing

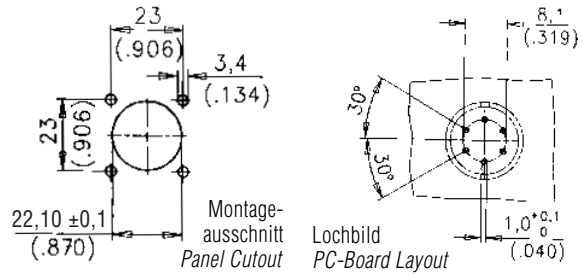

Beschreibung Description	Maßzeichnung Drawing	Polzahl No. of cont.	Bestellnummer / Part Number		
			Lötanschluß / solder termin. Kontaktfläche / contact plating silber / silver		Crimpanschluß crimp termination
Gerätestecker, Tauchlötanschluß. Male receptacle, termination: straight dip solder.		6 + PE	C015 50C006 100 1	-	-
		6 pol.	C015 50C006 100 2	-	-
Gerätestecker, Lötanschluß. Male receptacle, solder termination.		6 + PE	C015 30C006 100 1	-	-
		6 pol.	C015 30C006 100 2	-	-

C 015

Crimpkontakte
für Kabeldose
*Crimp Contacts
for Female Cable Connectors*



Beschreibung <i>Description</i>	Kontaktdurchmesser <i>Contact Diameter</i>	Anschlußquerschnitt <i>Max. Wire Gauge</i>	Verp.-Einheit <i>Supplied as</i>	Stück <i>Pcs.</i>	Bestell-Nr. <i>Part Number</i>
Buchsenkontakte, Kontaktfläche Silber <i>Socket contacts, contact plating silver</i>	1,6 mm	0,14-0,5 mm ²	Einzelkontakt <i>individual</i>	100	VN02 016 0003 (1)
			Bandkontakte <i>contacts on reel</i>	200	ZN02 016 0003 (1)
		2000		HN02 016 0003 (1)	
		0,5-1,5 mm ²	Einzelkontakt <i>individual</i>	100	VN02 016 0002 (1)
			Bandkontakte <i>contacts on reel</i>	200	ZN02 016 0002 (1)
				2000	HN02 016 0002 (1)

Verarbeitungswerkzeuge auf Anfrage. Bitte fordern Sie unseren Katalog „Crimpwerkzeuge“ an.
Crimping tools upon request. Please order our catalogue "Crimping Tools".

C 015

Derating Kurve
Current Derating Curve

Angaben nach DIN JEC 512 T3
alle Kontakte in Reihe
Steckverbinder 6 + PE

*acc. to DIN JEC 512 T3
all contacts with same load
connector 6 + PE*

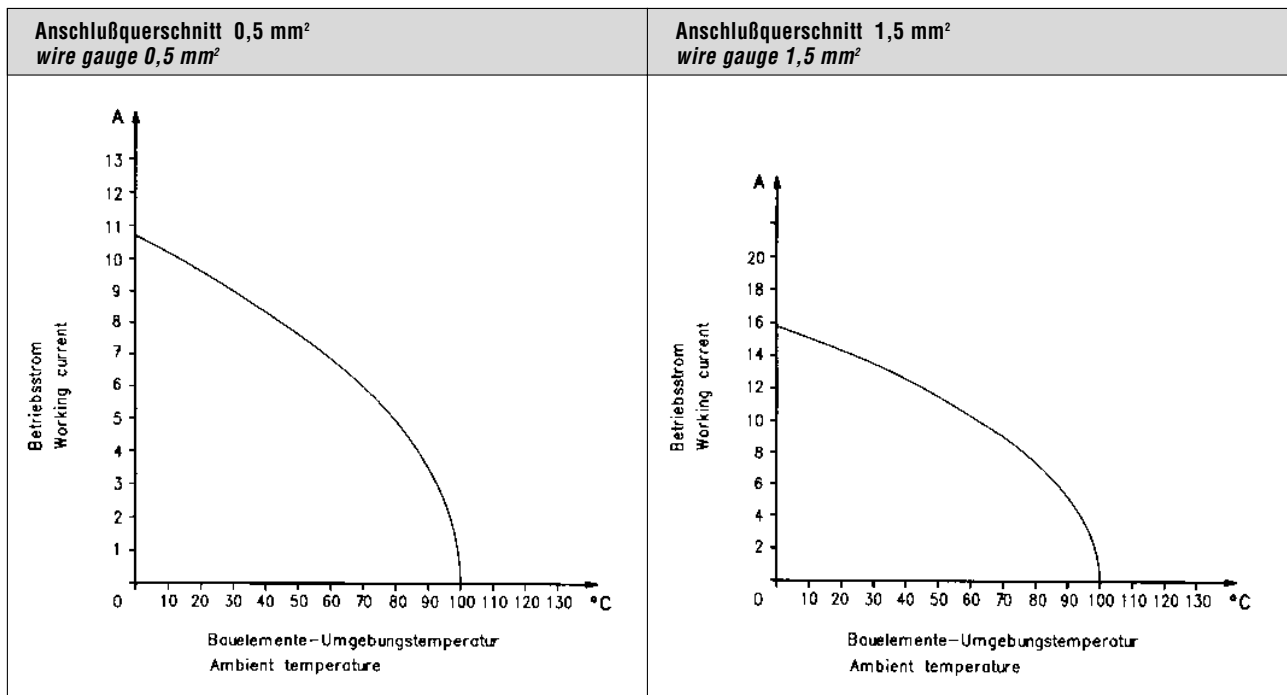

Deutschland

Dreieich

SPOERLE ELECTRONIC
Handelsgesellschaft
mbH & Co.
Max-Planck-Strasse 1-3
63303 Dreieich
Telefon 0 61 03 / 30 4-0
Telefax 0 61 03 / 30 42 01

Frankfurt

Nies Electronic GmbH
Edisonstraße 7
60388 Frankfurt
Telefon 0 61 09 / 73 64-0
Telefax 0 61 09 / 73 64-49

RS-Components GmbH
Hessenring 13b
64546 Mörfelden-Walldorf
Telefon 0 61 05 / 4 01-2 22
Telefax 0 61 05 / 4 01-2 65

Hamburg

Walter Kluxen Elektronik GmbH
Neuer Höltingbaum 6
22143 Hamburg
Telefon 0 40 / 23 70 1-0
Telefax 0 40 / 23 70 1-596

München

tti Inc.
Siemensstraße 3
82174 Puchheim
Telefon 0 89 / 84 00 8-302
Telefax 0 89 / 84 00 8-392

MPS Terminal Industrie
Electronic GmbH
Eichenstraße 9
83043 Bad Aibling
Telefon 0 80 61 / 49 77-0
Telefax 0 80 61 / 49 77-49

Nürnberg

Novitronic GmbH
Elektronische Bauelemente
Donaustraße 36
90451 Nürnberg
Telefon 09 11/64 30-11
Telefax 09 11/64 30-44

Stuttgart

Deltrona GmbH
Dieselstraße 11
71332 Waiblingen
Telefon 0 71 51 / 9 53 00
Telefax 0 71 51 / 1 81 62

Avnet GmbH
Benzstr. 1
70839 Gerlingen
Telefon 0 71 56 / 4 39-0
Telefax 0 71 56 / 4 39-111

International

Argentina

Amphenol Argentina
Av. Callao 930
2nd Floor Office B "Plaza"
C1023 AAP Buenos Aires
Phone +54 / 11 / 48 15 35 79
Fax +54 / 11 / 48 14 57 79

Australia

Amphenol Australia Ltd.
2 Fiveways Blvd
Keysborough
Victoria 31 73
Phone +61 / 3 / 8796 / 8888
Fax +61 / 3 / 8796 / 8801

Brasilia

Amphenol do Brasil Ltda.
Rua Diogo Moreira 132, 20th Floor
CEP 05423-010 Sao Paulo SP
Phone +55 / 11 / 3815.1003
Fax +55 / 11 / 3815.1629

France

Amphenol Socapex France
21 Chemin du Défois
B.P. 349
39105 Dole Cedex
Phone +33 / 3 / 84 82 94 00
Fax +33 / 3 / 84 82 94 11

Great Britain

Pyle-National
A division of Amphenol Ltd.
Unit D1, Crossgate Drive
Queens Drive
Industrial Estate
Nottingham, NG2 1LW
Phone: +44 / 115 / 986 6200
Fax +44 / 115 / 986 6212

Hongkong

Amphenol East Asia Limited
Units 2201-02, Railway Plaza
39 Chatham Road South
Tsimshatsui, Kowloon
Phone +8 52 / 26 99 / 26 63
Fax +8 52 / 26 88 / 09 74

India

Amphenol Limited
Plot No. 105 Bhosari Industrial Area
Pune - 411 026
Phone +91 / 20 / 7 12 14 18
Fax +91 / 20 / 7 12 05 81

Italy

Amphenol Italia S.p.A.
Via Barbaiana n. 5
I-20020 Lainate (MI)
Phone +39 / 2 / 93 254.1
Fax +39 / 2 / 93 254.445

Japan

Amphenol Japan, K.K.
2-3-27, Kudan Minami
Chiyoda-Ku
Tokyo 102
Phone +81 / 3 / 32 63 / 56 11
Fax +81 / 3 / 52 76 / 70 59

Korea

Amphenol DaeShin Limited
#802 Joong-Dong 1131-5
Wonmi-Ku
Bucheon-City
Kyunggi-Do
Korea 420-020
Phone +82 / 2 / 785 / 1588
Fax +82 / 2 / 589 / 1514

Mexico

Amphenol Mexico
Prolongacion Reforma 61 - 6 B2
Col. Paseo de las Lomas
C.P. 01330 Mexico D.F.
Phone +52 / 55 / 5258.9984
Fax +52 / 55 / 5081.6890

Netherlands

Amphenol Benelux b.v.
Hoofdveste 19
3992 AK Houten
Phone +31 / 30 / 6 35 80 00
Fax +31 / 30 / 6 37 78 99

Peoples Republic of China

Amphenol-Tuchel Electronics GmbH
China Branch
210-1 Taishan Road
Changzhou 213 022
Phone +86 / 05 19 / 5 11 03 01
Fax +86 / 05 19 / 5 11 02 99

Singapore

Amphenol East Asia Limited
Asia Pacific Sales Operation
Singapore Branch
300 Beach Road
#25-07 The Concourse
Singapore 199555
Phone +27 / 11 / 305-95 74
Fax +27 / 11 / 305-95 76

Sweden

Amphenol Scandinavia
Johanneslundsvägen 2
194 61 Upplands Väsby
Phone +46 / 8 / 59 41 04 40
Fax +46 / 8 / 59 03 38 00

Spain

Amphenol Ibérica
C/Comunidad de Madrid, 35-bis
oficina N° 55 "Edificio Burgosol"
E-28230 las Rozas Madrid
Phone +34 / 91 64 07 30 2
Fax +34 / 62 90 54 62 9

South Africa

Amphenol International Ltd
Chislehurst
30 Impala Road
Chislehurst
Sandton, 2146
Phone +27 / 11 / 7 83 95 17
Fax +27 / 11 / 7 83 95 19

Taiwan

Amphenol East Asia Ltd.
Taiwan Branch (H.K.)
116 Zhong Shan Road
Lane 956 Taoyuan City
Taiwan R.O.C. 330
Phone +886 / 3 / 370 / 7855
Fax +886 / 3 / 360 7259

USA

Amphenol-Tuchel Electronics
Representative Office
6900 Haggerty Road
Suite 200
Canton, Michigan 48187
Phone +1 / 734 / 451 6400
Fax +1 / 734 / 451 7197

Amphenol Corporation
Corporate Headquarters
358 Hall Avenue
Wallingford, CT 06492
Phone +1 / 203 / 2 65 / 89 00
Fax +1 / 203 / 2 65 / 86 28

Your engineering sales representatives:

Amphenol

Amphenol-Tuchel Electronics GmbH

August-Haeusser-Str. 10 · D-74080 Heilbronn · Germany · Phone +49 (0) 71 31/9 29-0 · Fax +49 (0) 71 31/9 29-486 · www.amphenol.de