



Connectivity Solutions

Complete or Partial Part #,
Competitor Part # or
Keywords.

Wireless

CATV

Audio & Video

Networking &
Structured Wiring

Military & Aerospace

Test & Measurement

Home

Member Access

Products

Connectors

Microwave Components

CATV Components

Coaxial Cable Assemblies

Structured Cabling & Connectors

Tools & Accessories

Customer Service

Request For Quote

Representatives

Distributors

Literature/Catalog Request

What's New

About Our Brands

Legal Terms

© 2007 All Rights Reserved

Product Detail



Product Line:	Johnson (Click for customer service)
Part Number:	108-0750-002
Description:	Banana Plug - Uninsulated Panel Mount Threaded Stud
Product Family:	BANANA PLUG
Body Material:	Brass per QQ-B-626D
Contact Finish:	Nickel
Contact Termination:	Solder
Current:	15 amps
Desc 2:	0.75
Description:	Uninsulated Threaded Stud
For Use With:	.166 (4.23) Banana Jack
Panel Thickness:	Up to .250 (6.35), .625 (16.00)
RoHS Compliant:	Yes

20070523-1523

Banana Plug - Uninsulated Panel Mount Threaded Stud

SPECIFICATIONS

Plug Body: Brass per QQ-B-626D

Plug Spring: Nickel silver per QQ-C-585

Finish: Nickel

Panel Thickness: Up to .25 (6.35) .625 (16.00)

Hardware: Nickel plated nut, stamped tin plated
solder terminal (unassembled)

RATINGS

Current: 15 amps

Contact Resistance: 0.010 ohms maximum

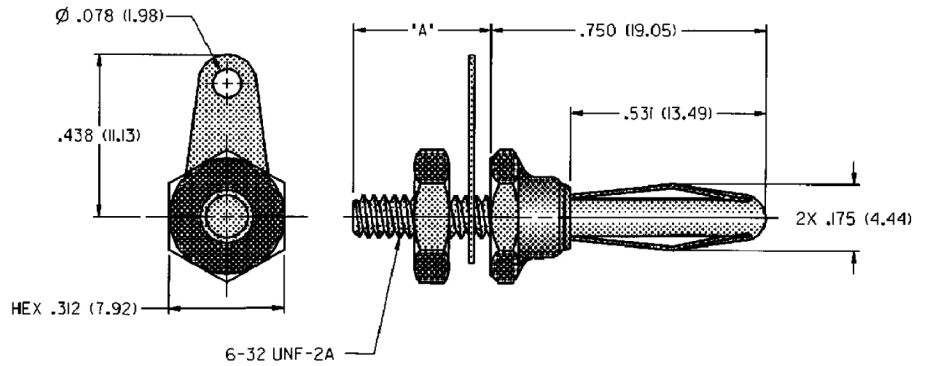

NICKEL PLATING	
108-0750-002	.750 (19.05)

For Standard Banana Jack: .166 (4.23) Diameter

FEATURES:

- Two stud lengths adapt to different panel sizes
- Pierced hole for up to 14 gauge wire