

COOPER

Bussmann®

Productivity Through Protection™

Disconnect Switches Catalog



COOPER Bussmann

Courtesy of Steven Engineering, Inc. • 230 Ryan Way, South San Francisco, CA 94080-6370 • General Inquiries: (800) 670-4183 • www.stevenengineering.com

Downloaded from Elcodis.com electronic components distributor

Bussmann®

Worldwide Circuit Protection Solutions

North America's leading supplier of fuses and fusible protection systems, Bussmann continues its 88-year history of blazing new trails of innovative technologies. Maker of the industry's first truly global product line, each item is backed by an efficient worldwide network of distribution, customer service and technical support.



Bussmann products include the most extensive circuit protection solutions approved for use in a variety of major standards: UL, CSA, IEC. . . Not to mention both European (DIN, British Standard) and North American styled fuses for a wide range of applications: industrial motor protection, power conversion, medium voltage, power distribution, telecommunications network equipment, electronics, and automotive. Manufacturing operations in the U.S., Denmark, and the United Kingdom have earned ISO 9000 certification. Bussmann customers are assured of only the utmost quality across every product line. Knowledgeable. Responsive. Customer focused. Bussmann continues to set the standard for circuit protection solutions around the world.

This catalog is intended to present product data and provide technical information that will help the end user with design application. Bussmann reserves the right, without notice, to change design or construction of any products and to discontinue or limit distribution of any products. Bussmann also reserves the right to change or update, without notice, any technical information contained in this catalog. Once a product has been selected, it should be tested by the user in all possible applications.

©2002 Cooper Industries, Bussmann Division
Printed in the U.S.A.

**Disconnect Switches
Compact, Heavy-Duty**

Table of Contents	
Fusible Disconnect Switches..... Page 2	Fusible
Non-Fusible Disconnect Switches..... Page 29	Non-Fused
Enclosed Fusible Disconnect Switches..... Page 69	Enclosed Fused
Enclosed Non-Fusible Disconnect Switches..... Page 79	Enclosed Non-Fused
Index by Part Number Page 88	

for Fusible Disconnect Switches

CFD30CC3 – FD800L3

Fusible

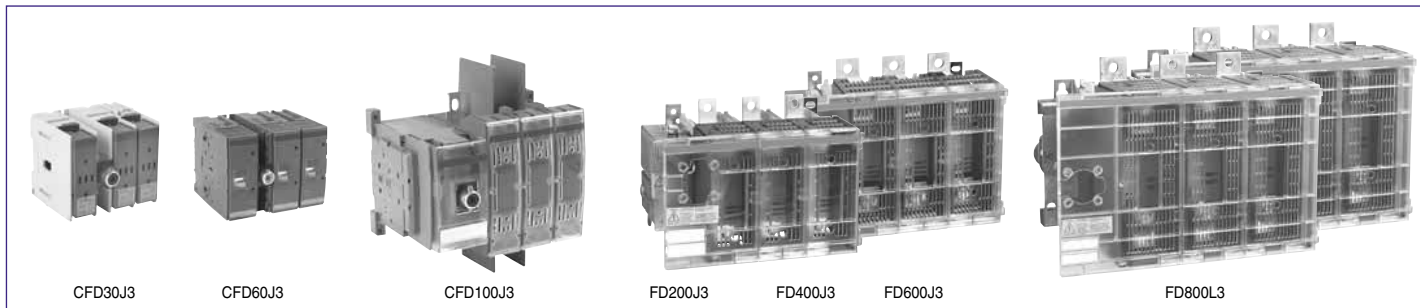

Non-Fused

Enclosed Fused

Enclosed Non-Fused

Catalog number	3 pole	CFD30CC3	CFD30J3	CFD60J3	CFD100J3	FD200J3	FD400J3	FD600J3	FD800L3
General purpose amp rating	A	30	30	60	100	200	400	600	800
Approvals^①	2 pole 3 pole 4 pole	N/A UL98 & IEC UL98 & IEC	N/A UL98 & IEC UL98 & IEC	N/A UL98 & IEC UL98 & IEC	UL98 & IEC UL98 & IEC UL98 & IEC	UL98 & IEC UL98 & IEC UL98 & IEC	UL98 & IEC UL98 & IEC UL98 & IEC	UL98 & IEC UL98 & IEC UL98 & IEC	UL98 & IEC UL98 & IEC UL98 & IEC
Technical ratings (UL, CSA)									
Max operating voltage	V	600	600	600	600	600	600	600	600
Max horsepower rating									
Three phase									
200 – 208V	HP	5/7.5	5/7.5	15	25	50	100/125	150	200
240V	HP	7.5	7.5	15	30	60	125	200	250
480V	HP	15	15	30	60	125	250	400	500
600V	HP	20	20	50	75	150	350	500	600
Single phase									
120V	HP	2	2	—	—	—	—	—	—
240V	HP	3	3	—	—	—	—	—	—
UL fuse class		CC	J	J	J	J,T	J,T	J,T	L
Technical ratings (IEC)									
Rated insulation and operational voltage, AC20 and DC20 ^②		1000	1000	750	750	1000	1000	1000	1000
Rated thermal current, I _{th}									
AC 20/DC 20 open	A	32	32	63	125	250	400	630	800
AC 20/DC 20 enclosed	A	32	32	63	125	250	400	600	720
AC 21A ≤500V	A	32	32	63	125	250	400	630	800
≤690V	A	32	32	63	125	250	400	630	800
Rated operational power AC23									
400/415V	kW	14/15	14/15	30	80/90	132/140	210/230	315/340	350/380
690V	kW	25	25	60	132	230	330	540	600
Physical characteristics									
Weight									
3 pole switch	lb	1.54	1.54	2.86	3.30	15.21	17.2	37.48	37.48
4 pole	lb	1.98	1.98	3.52	3.96	17.4	19.4	46.3	46.3
Dimension									
3 pole	H in	3.82	3.82	3.94	5.66	7.87	7.87	11.42	11.42
	W in	4.17	4.17	5.63	7.06	10.31	11.22	14.69	14.69
	D in	4.21	4.21	5.04	5.09	7.83	8.11	9.21	9.21
Accessories									
Double break contacts		S	S	S	S	S	S	S	S
Fuse cover		S	S	S	•	S	S	S	S
Terminal lug kit		Integral	Integral	Integral	BDTL24	BDTL25	BDTL26	BDTL27	BDTL27
Terminal shroud		Not required	Not required	Not required	•	•	•	•	•
Auxiliary contact		•	•	•	•	•	•	•	•
Handle UL/NEMA type									
Type 1, 3R, 12		•	•	•	•	•	•	•	•
Type 1, 3R, 4, 4X, 12		•	•	•	•	•	•	•	•
Conversion kit									
6 pole		•	•	•	•	•	•	•	•
Transfer		•	•	•	•	•	•	•	•
Bypass		—	—	—	—	•	•	•	•
Mechanical interlock		•	•	•	•	•	•	•	•
Electrical interlock		—	—	—	—	•	•	•	•

S = Standard
• = Available
— = Not available

UL listed, CSA approved, IEC rated, CE marked

① UL listed switches are also CSA approved.
② 1000V IEC 408

Base & DIN Rail Mounted

UL Fuse Class J, CC

For a complete assembly, please select one of each:

- 1 switch
- 1 handle
- 1 shaft



CFD30J3



CDS180S



CDH3S



CFD30J3



CDH3S, 5S



CDH4S, 6S



CDS_

30 Amp switches, 600V

UL general purpose amp rating	UL Fuse type 600V	Maximum horsepower rating					Terminal lugs		Catalog number
		Three phase					Wire size	Wire type	
		200V	208V	240V	480V	600V			
3 pole									
30	J	5	7.5	7.5	15	20	#18 – 8	Cu	CFD30J3
30 [Ⓞ]	CC	5	7.5	7.5	15	20	#18 – 8	Cu	CFD30CC3
4 pole									
30	J	5	7.5	7.5	15	20	#18 – 8	Cu	CFD30J4
30 [Ⓞ]	CC	5	7.5	7.5	15	20	#18 – 8	Cu	CFD30CC4

Selector handles — for use with shafts .20 x .20" (5 x 5 mm)

NEMA type	IEC type	Color	Defeatable	Padlockable	Weight (lbs.)	Catalog number
All marked both O/I & Off/On						
1,3R,12	IP65	Black	—	Yes	0.16	CDH3S
1,3R,12	IP65	Red/Yellow	—	Yes	0.16	CDH4S
1,3R,12	IP65	Black	Yes	Yes	0.16	CDH5S
1,3R,12	IP65	Red/Yellow	Yes	Yes	0.16	CDH6S

Shafts — for use with CDH selector handles .20 x .20" (5 x 5 mm)

Shaft length (inches/mm)	Mounting depth (inches)	Weight (lbs.)	Catalog number
3.3/85	5.5 – 5.7	0.04	CDS85S
4.1/105	5.5 – 6.5	0.04	CDS105S
4.7/120	5.5 – 7.1	0.05	CDS120S
5.1/130	5.5 – 7.5	0.05	CDS130S
7.1/180	6.3 – 9.4	0.08	CDS180S
9.8/250	9.1 – 12.2	0.10	CDS250S
13.0/330	12.2 – 15.4	0.14	CDS330S

[Ⓞ] Rejection style fuses only.

Fusible

Non-Fused

Enclosed Fused

Enclosed Non-Fused

for 30A Fusible Disconnect Switches

For a complete assembly, please select one of each:

- 1 switch
- 1 handle
- 1 shaft



CFD30J3



CDS67P



BDH107

Fusible

Non-Fused

Enclosed Fused

Enclosed Non-Fused



BDH104,106



BDH105, 107



CDS__P

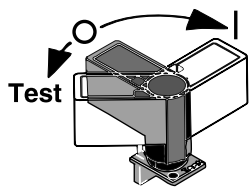

BDH79

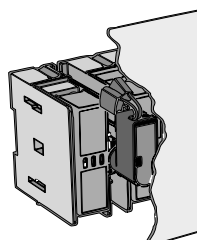

BDH79 Mounted

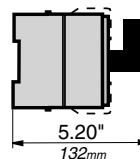

5.20"/132mm
BDH79 Mounted depth

Pistol handles — for use with shafts .20 x .20" (5 x 5 mm)

NEMA type	IEC type	Color	Marking	Length inches/mm	Defeatable	Padlockable	Weight (lbs.)	Catalog number
1,3R,12	IP65	Black	O/I & Off/On	1.8/45	Yes	Yes	0.28	BDH104
1,3R,12	IP65	Red/Yellow	O/I & Off/On	1.8/45	Yes	Yes	0.28	BDH105
1,3R,12	IP65	Black	O/I & Off/On	2.6/65	Yes	Yes	0.29	BDH106
1,3R,12	IP65	Red/Yellow	O/I & Off/On	2.6/65	Yes	Yes	0.29	BDH107
1,3R,4,4X,12	IP65	Black	O/I & Off/On	2.6/65	Yes	Yes	0.29	CDHXB65
1,3R,4,4X,12	IP65	Red/Yellow	O/I & Off/On	2.6/65	Yes	Yes	0.29	CDHXY65
1,3R,12	IP65	Black	Off/On/Test	2.6/65	Yes	Yes	0.29	BDH106T
1,3R,12	IP65	Red/Yellow	Off/On/Test	2.6/65	Yes	Yes	0.29	BDH107T

Shafts — for use with pistol handles .20 x .20" (5 x 5 mm)

Shaft length (inches/mm)	Mounting depth (in inches)	Weight (lbs.)	Catalog number
5.9/150	4.9 – 8.9	0.07	CDS48P
6.7/170	5.9 – 9.7	0.08	CDS67P
10.4/265	9.5 – 13.4	0.12	CDS49P
15.8/400	15.0 – 18.7	0.18	CDS50P
19.7/500	20.5 – 22.6	0.23	CDS99P

Direct mount handle — mounts directly to switch, no shaft necessary

NEMA type	Color	Marking	Length mm	Padlockable	Weight (lbs.)	Catalog number
1	Blk	O/I/Test	50	Yes	0.10	BDH79

for 30A Fusible Disconnect Switches



CFD30J3 with auxiliaries

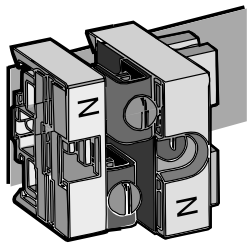

CFDZX171

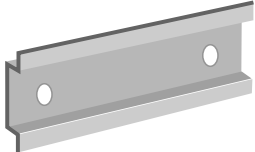

NDNA100

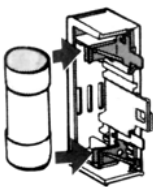

BDZD48



CXYB67121

Auxiliary contacts^①

Description	For use on:	Weight (lbs)	AC thermal amp rating	AC rated voltage	Catalog number
Form C 1 N.O. & 1 N.C. (2 maximum)	CFD30_ for direct mounting to switch	0.04	6	250	BDAUX157
1 N.O. 1 N.C. (6 maximum)	CFD30_ CDAUXB mounting base required	0.03	NEMA A600,P600		CDAUX10 CDAUX01K

Mounting base

Description	For use with:	Weight (lbs)		Catalog number
Mounting base	CDAUX10, CDAUX01K	0.08		CDAUXB

Terminal pole

Description	For use on:	Weight (lbs)	AC thermal amp rating	AC rated voltage	Catalog number
Detachable neutral mounts on side of switch or DIN rail	CFD30_	0.45	30	600	CFDZX171

DIN rail

Description	For use on:	Weight (lbs.)	Length inches/mm	Catalog number
35mm DIN Rail	CFD30_	.38	39.4/1000	NDNA100
35mm Aluminum DIN Rail	CFD30_	.75	78.8/2000	NDNA200

Fuse Carriers (Replacement Parts)

Description	For use on:		Catalog number
CC fuse carrier	BDCF30CC_		BDZD48
J fuse carrier	BDCF30J_		BDZD28
Class CC Solid link	CFD30_		NNB-R

Terminal cover (replacement part)

Description	For use on:		Catalog number
Covers terminal below fuse carrier	CFD30_		CDBY67121

① UL File # E83510

Fusible

Non-Fused

Enclosed Fused

Enclosed Non-Fused

for 30A Fusible Disconnect Switches

Fusible

Non-Fused

Enclosed Fused

Enclosed Non-Fused

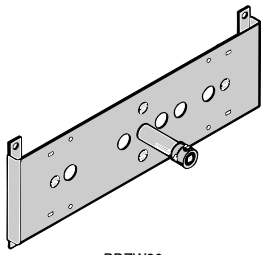

BDZW30

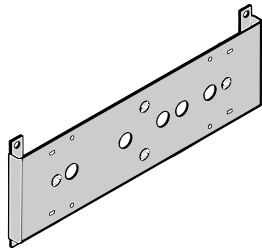

BDZW4

Conversion mechanisms

- Switches are not included

Description	For use on:	Weight (lbs)		Catalog number
6 pole	CFD	1.74		BDZW5
8 pole	CFD	1.90		BDZXB
Transfer				
3 pole	CFD	2.11	Type 1,3R, 12	BDZW30
3 pole	CFD	2.11	Type 1,3R, 4, 4X, 12	BDZW30X
4 pole	CFD	2.30	Type 1,3R, 12	Call Factory
4 pole	CFD	2.30	Type 1,3R, 4, 4X, 12	Call Factory
Mechanical interlock				
3 pole	CFD	1.74		BDZW4
4 pole	CFD	1.90		Call Factory

6 or 8 pole — BDZW5

6 (8) pole mechanism allows two switches, controlled by one handle, to open or close simultaneously.

Equipment required for a complete installation:

- One conversion mechanism
- Two disconnect switches
- One handle
- One 5 mm shaft

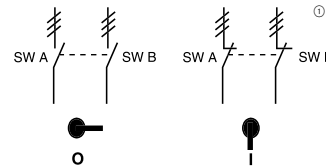

	POS. O	POS. I
SW. A	O	X
SW. B	O	X

X = Closed
O = Open

Transfer — BDZW30

Transfer mechanism manually transfers between two power sources using two switches and a center OFF position. A 3 position handle is included.

Equipment required for a complete installation:

- One conversion mechanism
- Two disconnect switches
- One 5 mm shaft

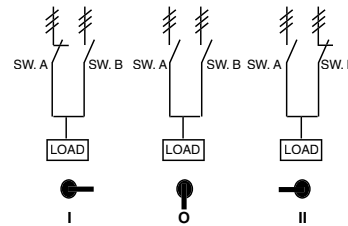

	POS. I	POS. O	POS. II
SW. A	X	O	O
SW. B	O	O	X

X = Closed
O = Open

Mechanical interlock — BDZW4

Mechanical interlock mechanism prevents both switches from being in the "ON" position at the same time.

Equipment required for a complete installation:

- One conversion mechanism
- Two disconnect switches
- Two handles
- Two 5 mm shafts

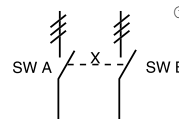

	SW. A POS. I	SW. B POS. I
SW. A	X	O
SW. B	O	X

X = Closed
O = Open

① = Three poles

for Fusible Disconnect Switches
UL Fuse Class J

For a complete assembly, please select one of each:

- 1 switch
- 1 handle
- 1 shaft
- 1 terminal lug kit



CFD60J3



BDS210



BDH58



CFD60J3

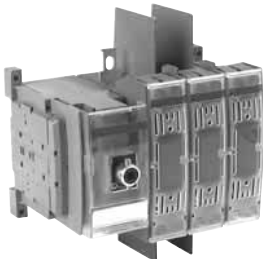

CFD100J3



BDH58,60



BDH59,61



BDS_

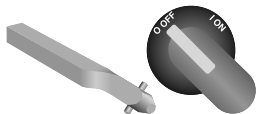

BDST_

60 – 100 Amp switches, 600V

UL general purpose amp rating	UL Fuse type 600V	Maximum horsepower rating					Catalog number	
		Three phase						
		200V	208V	240V	480V	600V		
3 pole	60	J	15	15	15	30	50	3 pole CFD60J3 CFD100J3
	100	J	25	25	30	60	75	
4 pole	60	J	15	15	15	30	50	4 pole CFD60J4 CFD100J4
	100	J	25	25	30	60	75	

Pistol handles — .24 x .24" (6 x 6mm)

NEMA/UL type	IEC type	Color	Length in/mm	Marking	Defeatable	Padlockable	Weight (lbs.)	Catalog number
1,3R,12	IP65	Black	2.6/65	O/I & Off/On	Yes	Yes	0.29	BDH58
1,3R,12	IP65	Red/Yel	2.6/65	O/I & Off/On	Yes	Yes	0.29	BDH59
1,3R,12	IP65	Black	3.1/80	O/I & Off/On	Yes	Yes	0.30	BDH60
1,3R,12	IP65	Red/Yel	3.1/80	O/I & Off/On	Yes	Yes	0.30	BDH61
1,3R,4,4X,12	IP65	Black	3.1/80	O/I & Off/On	Yes	Yes	0.30	CDHXB86
1,3R,4,4X,12	IP65	Red/Yel	3.1/80	O/I & Off/On	Yes	Yes	0.30	CDHXY86

Shafts — .24 x .24" (6 x 6mm)

Shaft length (inches/mm)	Mounting depth (inches)	Weight (lbs.)	Catalog number
5.9/150	5.5 – 8.5	0.09	BDS150
8.3/210	8.0 – 11.0	0.13	BDS210
11.4/290	11.0 – 14.0	0.18	BDS290
14.2/360	13.8 – 16.8	0.23	BDS360
16.9/430	16.5 – 19.7	0.27	BDS430

Twisted shafts — Rotates handle 45° .24 x .24" (6 x 6mm)

Shaft length (inches/mm)	Mounting depth (inches)	Weight (lbs.)	Catalog number
5.1/130	4.8 – 7.8	0.08	BDST4
8.3/210	8.0 – 11.0	0.13	BDST25
11.4/290	11.0 – 14.0	0.18	BDST29
14.2/360	13.8 – 16.8	0.23	BDST30

Direct mount handle — mounts directly to switch, no shaft necessary

NEMA type	Color	Marking	Length mm	Padlockable	Weight (lbs.)	Catalog number
1	Black	O/I/Test	50	Yes	0.10	CDH4

Fusible

Non-Fused

Enclosed Fused

Enclosed Non-Fused

for 60A – 100A Fusible Disconnect Switches

Fusible

Non-Fused

Enclosed Fused

Enclosed Non-Fused



BDTL24

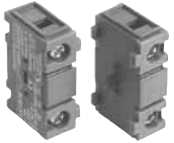

CDAUX10, CDAUX01K



CFC60J



CFCVR100



CFTS100



CFZ1

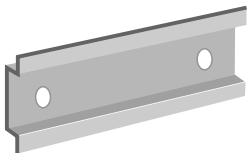

NDNA100

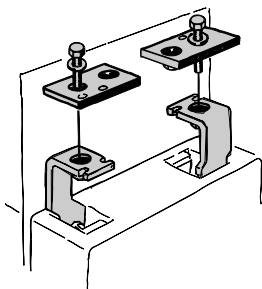

BDTA1

Terminal lug kit

For use on:	Wire size	Kit weight (lbs)	Wire type	Terminal lugs per kit	Catalog number
CFD60J_	#14 – 4	—	Cu	—	Integral
CFD100J_	#14 – 2/0	0.43	Cu/Al	6	BDTL24

Auxiliary contacts

Description	For use on:	Weight (lbs)	AC thermal amp rating	AC rated voltage	Catalog number
1 N.O. 1 N.C.	CFD60 – CFD100	0.07 0.07	10 10	600 600	CDAUX10 CDAUX01K

Replacement fuse clip

Description	For use on:	Weight (lbs)	AC thermal amp rating	AC rated voltage	Catalog number
Removable fuse carrier	CFD60				CFC60J

Replacement fuse covers

Description	For use on:	Weight (lbs)	AC thermal amp rating	AC rated voltage	Catalog number
Transparent fuse cover	CFD100				CFCVR100

Terminal shroud

Description	For use on:	Weight (lbs)	AC thermal amp rating	AC rated voltage	Catalog number
Includes one terminal shroud for line or load side	CFD100, 1-POLE	0.04			CFTS100

Terminal poles

Description	For use on:	Weight (lbs)	AC thermal amp rating	AC rated voltage	Catalog number
Detachable neutral mounts on side of switch or DIN rail	CFD60	0.13	63	600	CFZ1
	CFD100	0.31	125	600	CFZ2

DIN rail

Description	For use on:	Weight (lbs.)	Length inches/mm	Catalog number
35mm Aluminum DIN Rail	CFD60	.38	39.4/1000	NDNA100
35mm Aluminum DIN Rail	CFD60	.75	78.8/1000	NDNA200

“T” type fuse adapter kit

Description	For use on:	Weight (lbs)	AC thermal amp rating	AC rated voltage	Catalog number
100A, 600V	CFD100				BDTA1

for 60A – 100A Fusible Disconnect Switches

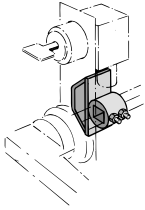

CDETL-ZW16

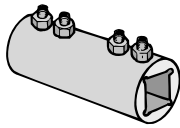

BDZX167
BDZW9S

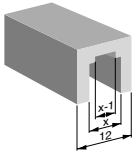

CDZK19
(X=6MM)

Locking accessories

Description	For use on:	Weight (lbs)		Catalog number
Cam attachment for Kirk Key, Castell, Lowe & Fletcher and Ronis interlock. Cam attachment for adapting to the interlock system. The interlock is not included.	CFD60 – CFD100	0.25		CDETL-ZW16

Shaft extension coupler

Description	For use on:	Weight (lbs)		Catalog number
Joins two shafts together for applications where extended length is required	6mm shafts 12mm shafts	0.26 0.26		BDZX167 BDZW9S

Shaft adapter

Description	For use on:	Weight (lbs)		Catalog number
Adapts one end of a 6mm shaft to 12mm. Use with shaft extension coupler	6mm shafts	0.20		CDZK19

Fusible

Non-Fused

Enclosed Fused

Enclosed Non-Fused

for 60A – 100A Fusible Disconnect Switches

Fusible

Non-Fused

Enclosed Fused

Enclosed Non-Fused

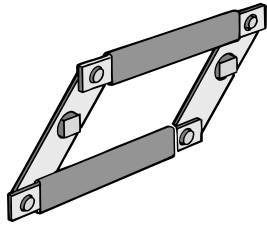

BDZW2

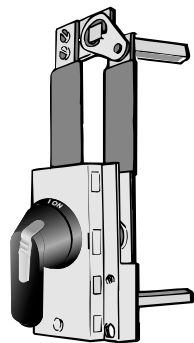

BDZW1

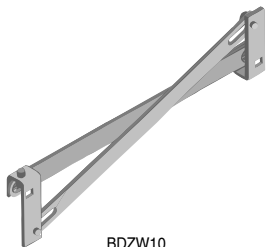

BDZW10

Conversion mechanisms

- Switches are not included

Description	For use on:	Weight (lbs)	Catalog number
6 and 8 pole	CFD60 – CFD100	1.52	BDZW2
Transfer	CFD60 – CFD100	2.20	BDZW1
Transfer (4X)	CFD60 – CFD100	2.20	BDZW1X
Mechanical interlock	CFD60 – CFD100	0.55	BDZW10

6 or 8 pole — BDZW2

6 (8) pole mechanism allows two switches controlled by one handle, to open or close simultaneously. Shafts included.

Equipment required for a complete installation:

- One conversion mechanism
- Two disconnect switches
- One handle

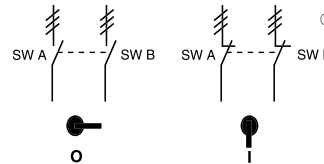

	POS. O	POS. I
SW. A	O	X
SW. B	O	X

X = Closed
O = Open

Transfer — BDZW1, BDZW1X

Transfer mechanism manually transfers between two power sources using two switches and a center OFF position. A 3 position handle is included.

(UL Type 1,3R,12) or
(UL Type 1,3R4,4X,12)

Shafts included.

Equipment required for a complete installation:

- One conversion mechanism
- Two disconnect switches

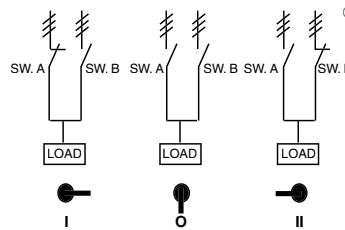

	POS. I	POS. O	POS. II
SW. A	X	O	O
SW. B	O	O	X

X = Closed
O = Open

Mechanical interlock — BDZW10

Mechanical interlock mechanism prevents both switches from being in the "ON" position at the same time.

Equipment required for a complete installation:

- One conversion mechanism
- Two disconnect switches
- Two handles
- Two shafts

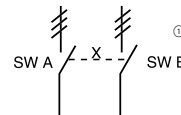

	SW. A POS. I	SW. B POS. I
SW. A	X	O
SW. B	O	X

X = Closed
O = Open

⊙ = Three poles

Fusible Disconnect Switches

UL Fuse Class J, T, L

For a complete assembly, please select one of each:

- 1 switch
- 1 handle
- 1 shaft
- 1 terminal lug kit

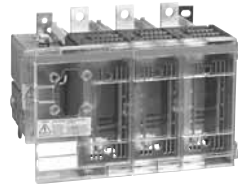

FD200J3



BDS280



BDH114



BDTL25

200 – 800 Amp switches, 600V

UL general purpose amp rating	UL Fuse type 600V	Maximum horsepower rating					Catalog number
		Three phase					
		200V	208V	240V	480V	600V	
2 pole							2 pole
200	J [⊙]	—	—	—	—	—	FD200J2
400	J [⊙]	—	—	—	—	—	FD400J2
600	J [⊙]	—	—	—	—	—	FD600J2
800	L	—	—	—	—	—	FD800L2
3 pole							3 pole
200	J [⊙]	50	50	60	125	150	FD200J3
400	J [⊙]	100	125	125	250	350	FD400J3
600	J [⊙]	150	150	200	400	500	FD600J3
800	L	200	200	250	500	600	FD800L3
4 pole							4 pole
200	J [⊙]	50	50	60	125	150	FD200J4
400	J [⊙]	100	125	125	250	350	FD400J4
600	J [⊙]	150	150	200	400	500	FD600J4
800	L	200	200	250	500	600	FD800L4

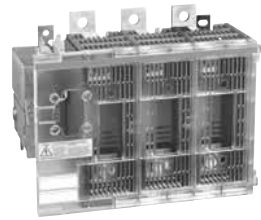

FD400J3

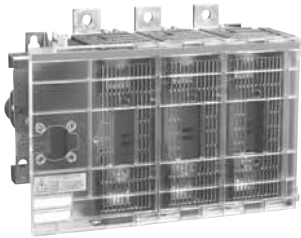

FD600J3
FD800L3



BDH112



BDH113

Pistol handles — □ .47 x .47" (□ 12 x 12mm)

NEMA type	IEC type	Color	Length inches/mm	Marking	Defeatable	Padlockable	Weight (lbs)	Catalog number
1,3R,12	IP65	Black	4.9/125	O/I & Off/On	Yes	Yes	0.39	BDH112
1,3R,12	IP65	Red/Yel	4.9/125	O/I & Off/On	Yes	Yes	0.39	BDH113
1,3R,12	IP65	Black	5.7/145	O/I & Off/On	Yes	Yes	0.39	BDH114
1,3R,12	IP65	Red/Yel	5.7/145	O/I & Off/On	Yes	Yes	0.39	BDH115
1,3R,12	IP65	Black	6.9/175	O/I & Off/On	Yes	Yes	0.41	BDH116
1,3R,12	IP65	Red/Yel	6.9/175	O/I & Off/On	Yes	Yes	0.41	BDH117
1,3R,4,4X,12	IP65	Black	5.7/145	O/I & Off/On	Yes	Yes	0.39	CDHXB12
1,3R,4,4X,12	IP65	Red/Yel	5.7/145	O/I & Off/On	Yes	Yes	0.39	CDHXY12
1,3R,4,4X,12	IP65	Black	6.9/175	O/I & Off/On	Yes	Yes	0.41	CDHXB22
1,3R,4,4X,12	IP65	Red/Yel	6.9/175	O/I & Off/On	Yes	Yes	0.41	CDHXY22
1,3R,4,4X,12	IP65	Metal	8.7/220	Off/On	—	Yes	1.50	BDH8

⊙ J type fuse clips are standard. If 600V Type "T" fuse clips are desired, please order a "T" type fuse adapter kit.

Fusible

Non-Fused

Enclosed Fused

Enclosed Non-Fused

for 200A – 800A Fusible Disconnect Switches

Fusible

Non-Fused

Enclosed Fused

Enclosed Non-Fused



BDS_

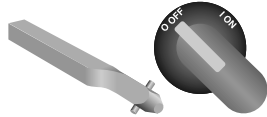

BDS_45



BDTL25

BDTL26



BDTL27



BDTL175



BDTL175/400



BDA_

Shafts — □ .47 x .47" (□ 12 x 12mm)

Shaft length inches/mm	 Mounting depth [Ⓢ] in inches	Weight (lbs)	Catalog number
For use on FD200J_ – FD400J_			
8.7/220	7.9 – 12.2	0.61	BDS220
9.8/250	9.1 – 13.4	0.70	BDS250
11.0/280	10.2 – 14.5	0.77	BDS280
12.8/325	12.0 – 16.3	0.90	BDS325
15.6/395	14.8 – 19.1	1.10	BDS395
18.3/465	17.5 – 21.9	1.32	BDS465
21.1/535	20.3 – 24.6	1.54	BDS535
For use on FD600J_ – FD800J_			
9.8/250	10.0 – 12.8	0.70	BDS250
11.0/280	11.2 – 14.0	0.77	BDS280
12.8/325	13.0 – 15.8	0.90	BDS325
15.6/395	15.8 – 18.6	1.10	BDS395
18.3/465	18.5 – 21.3	1.32	BDS465
21.1/535	21.1 – 24.1	1.54	BDS535

Twisted shafts — Rotates handle 45° □ .47 x .47" (□ 12 x 12mm)

Shaft length (inches/mm)	 Mounting depth (inches)	Weight (lbs.)	Catalog number
For use on FD200J_ – FD400J_			
11.0/280	10.2 – 14.5	0.77	BDS28045
12.8/325	12.0 – 16.3	0.90	BDS32545
18.3/465	17.5 – 21.9	1.32	BDS46545
For use on FD600J_ – FD800J_			
11.0/280	11.2 – 14.0	0.77	BDS28045
12.8/325	13.0 – 15.8	0.90	BDS32545
18.3/465	18.5 – 21.3	1.32	BDS46545

Terminal lug kit

For use on:	Wire size	Kit weight (lbs)	Wire type	Terminal lugs per kit	Catalog number
FD200J_	#6 – 300 kcmil	0.93	Cu/Al	6	BDTL25
FD200J	(6) #14 – 6 kcmil	0.93	Cu/Al	3	BDTL175
FD400J_	#2 – 600 kcmil	3.50	Cu/Al	6	BDTL26
FD600J – FD800L	(12)#14-16 – 600 kcmil	1.10	Cu/Al	3	BDTL175/400
FD600J_ & FD800L_	(2)#2 – 600 kcmil	4.62	Cu/Al	6	BDTL27

“T” type fuse adapter kit

For use on:	AC thermal amp rating	AC rated voltage	Poles	Catalog number
FD200J_	200	600	3	BDA2
FD400J_	400	600	3	BDA4
FD600J_	600	600	3	BDA6

Ⓢ Mounting depth is the distance from the outside of the door to the disconnect switch mounting plate. Shaft can be cut to desired length.

for 200A – 800A Fusible Disconnect Switches

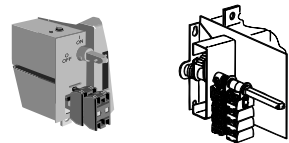

BDAUX_ 200A & 400A Switches
BDAUX_ 600A & 800A Switches

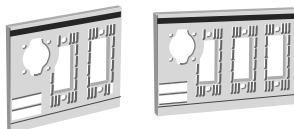

BDZX213
BDZX271
BDZX216
BDZX190
BDZX272
BDZX196

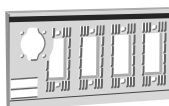

BDZX191
BDZX273
BDZX197



BDZX204

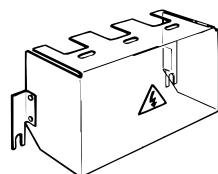

BDT5F_

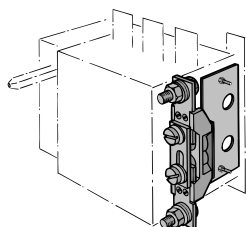

BDTP85
BDTP88

Auxiliary contacts^①

Description	For use on:	Weight (lbs)	AC thermal amp rating	AC rated voltage	Catalog number
1 N.O. + 1 N.C.	FD200 – FD800	0.20	10	600	BDAUX1
2 N.O. + 2 N.C.		0.26	10	600	BDAUX2
4 N.O. + 4 N.C.		0.40	10	600	BDAUX3
2 N.O.		0.18	10	600	BDAUX4
4 N.O.		0.25	10	600	BDAUX5
8 N.O.		0.40	10	600	BDAUX6

Fuse covers (replacement part)

Description	For use on:	Weight (lbs)	Catalog number
2 pole	FD200	0.30	BDZX213
3 pole		0.40	BDZX190
4 pole		0.53	BDZX191
2 pole	FD400	0.30	BDZX271
3 pole		0.40	BDZX272
4 pole		0.53	BDZX273
2 pole	FD600 – FD800	0.40	BDZX216
3 pole		0.50	BDZX196
4 pole		0.67	BDZX197

Fuse cover interlock

Description	For use on:	Catalog number
Prevents the fuse cover from being opened when the switch is in the ON position	FD200 – FD800	BDZX204

Terminal shroud

Description	For use on:	Weight (lbs)	Catalog number
Includes one terminal shroud for line or load side	FD200	0.13	BDTSF2
	FD400	0.13	BDTSF4
	FD600 – FD800	0.11	BDTSF6

Terminal pole

Description	For use on:	Weight (lbs)	AC thermal amp rating	AC rated voltage	Catalog number
Detachable neutral mounts on side of switch or DIN rail	FD200 – FD400	1.04	400	600	BDTP85
	FD600 – FD800	1.19	800	600	BDTP88

① UL file #E57057

Fusible

Non-Fused

Enclosed Fused

Enclosed Non-Fused

for 200A – 800A Fusible Disconnect Switches

Fusible

Non-Fused

Enclosed Fused

Enclosed Non-Fused

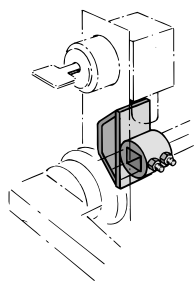

CDETL-ZW5

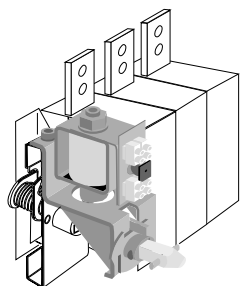

CDETL-ZT80

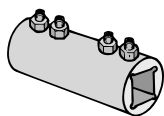

BDZW95

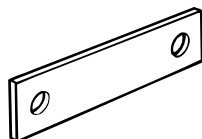

FDSBZK98
FDSBZL79

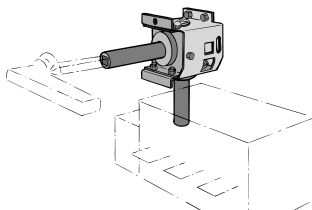

BDZX108

Locking accessories

Description	For use on:	Weight (lbs)	Catalog number
Cam attachment for Kirk Key, Castell, Lowe & Fletcher and Ronis interlock. For adapting to the interlock system. The interlock is not included.	FD200 – FD800	0.29	CDETL-ZW5
Electrical interlock Closed circuit principle for interlocking the switch movement. When the coil circuit is dead, A-types cannot be operated to ON-position and L-types cannot be operated to ON- or OFF-position. Coil voltages 110VAC, 220VAC, 24VDC, 48VDC, 60 VDC, 110VDC, 220VDC, P = 15W	FD600 – FD800	2.42	CDETL-ZT80A/★ CDETL-ZT80L/★

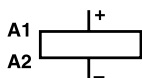

★ - Coil voltage

Shaft extension coupler

Description	For use on:	Weight (lbs)	Catalog number
Joins two shafts together for applications where extended length is required	12mm shafts	0.26	BDZW95

Shorting bars

Description	For use on:	AC thermal amp rating	AC rated voltage	Catalog number
Solid links (1 per kit)	FD200 – FD400	400	600	FDSBZK98
	FD600 – FD800	800	600	FDSBZL79

90° angle kit

Description	For use on:	Weight (lbs)	Catalog number
Converts switch mechanism from front operation to side operation	FD200 – FD800	4.63	BDZX108

for 200A – 800A Fusible Disconnect Switches

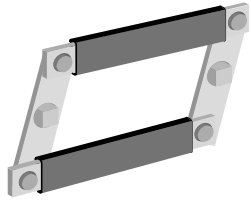

BDZW9

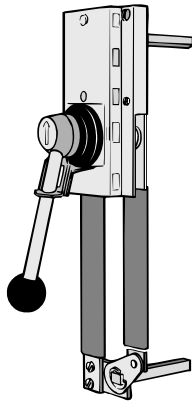

BDZW12

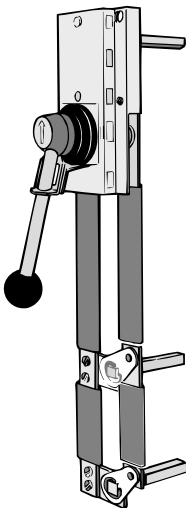

BDZW13

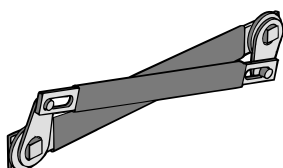

BDZW3
BDZW14
BDZW15

Conversion mechanisms

- Switches are not included

Description	For use on:	Weight (lbs)	Catalog number
6 or 8 pole Transfer Bypass	FD200 – FD800	2.42	BDZW9 BDZW12 BDZW13
		10.1	
		8.81	
Mechanical interlock	FD200 – FD800	1.26	BDZW3 BDZW14 BDZW15
		1.15	
		2.64	

6 or 8 pole — BDZW9

6 (8) pole mechanism allows two switches controlled by one handle, to open or close simultaneously.

Equipment required for a complete installation:

- One conversion mechanism
 - Two disconnect switches
 - One handle
 - One additional shaft
- (Only one shaft is included with mechanism)

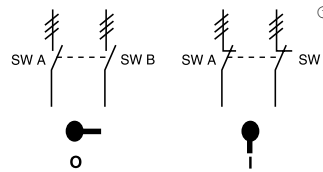

	POS. O	POS. I
SW. A	O	X
SW. B	O	X

X = Closed
O = Open

Transfer — BDZW12

Transfer mechanism manually transfers between two power sources using two switches and a center OFF position. A 3 position handle is included. BDH21 (UL Type 1, 3R, 4, 4X & 12).

Equipment required for a complete installation:

- One conversion mechanism
- Two disconnect switches
- Two BDZW95 shaft extension couplers
- Two shafts

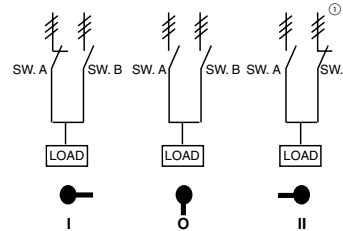

	POS. I	POS. O	POS. II
SW. A	X	O	O
SW. B	O	O	X

X = Closed
O = Open

Bypass — BDZW13

Bypass mechanism operates three switches: Two switches in series and one changeover switch to allow power bypass. A 3 position handle is included. BDH6 (UL Type 1, 3R, 4, 4X & 12).

Equipment required for a complete installation:

- One conversion mechanism
- Three disconnect switches
- Three BDZW95 shaft extension couplers
- Three shafts

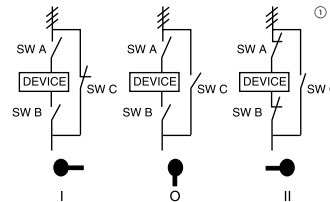

	POS. I	POS. O	POS. II
SW. A	O	O	X
SW. B	O	O	X
SW. C	X	O	O

X = Closed
O = Open

Mechanical interlock — BDZW3, BDZW14, BDZW15

Mechanical interlock mechanism prevents both switches from being in the "ON" position at the same time.

Equipment required for a complete installation:

- One conversion mechanism
- Two disconnect switches
- Two handles
- Two shafts

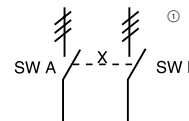

	SW. A POS. I	SW. B POS. I
SW. A	X	O
SW. B	O	X

X = Closed
O = Open

① ≡ = Three poles

30A – 400A UL Fuse Class J, CC, T

For a complete assembly, please select one of each:

- 1 switch
- 1 handle
- 1 shaft
- 1 terminal lug



CFD30J3S



CDS67P



BDH107SH



CFD60J3S

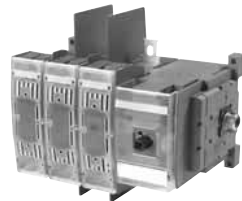

CFD100J3S

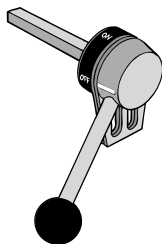

BDZX74



BDS325



BDTL25

Side operated switches — 3 pole

UL general purpose amp rating	UL fuse type 600V	Maximum horsepower rating					Weight (lbs)	Catalog number
		Three phase						
		200V	208V	240V	480V	600V		
30	J	5	7.5	7.5	15	20	1.54	CFD30J3S
30	CC	5	7.5	7.5	15	20	1.54	CFD30CC3S
60	J	15	15	15	30	50	3.52	CFD60J3S
100	J ^⓪	25	25	30	60	75	3.97	CFD100J3S
200	J ^⓪	50	50	60	125	150	15.21	FD200J3-S
400	J ^⓪	100	125	125	250	350	17.20	FD400J3-S

Handles

NEMA type	IEC type	Color	Length inches/mm	Marking	Defeatable	Padlockable	Weight	Catalog number
For use with CFD30J3S & CFD30CC3S								
1, 3R, 12	IP65	Black	2.6/65	OFF/ON/TEST	Yes	Yes	0.29	BDH106
1, 3R, 12	IP65	Red/Yellow	2.6/65	OFF/ON/TEST	Yes	Yes	0.29	BDH107
For use with CFD60J3S & CFD100J3S								
1, 3R, 12	IP65	Black	3.1/80	OFF/ON/TEST	Yes	Yes	0.30	BDH110
1, 3R, 12	IP65	Red/Yellow	3.1/80	OFF/ON/TEST	Yes	Yes	0.30	BDH111
For use with FD200J3-S & FD400J3-S								
1, 3R, 12	IP65	Black	4.9/145	OFF/ON/TEST	Yes	Yes	0.39	BDH114
1, 3R, 12	IP65	Red/Yellow	4.9/145	OFF/ON/TEST	Yes	Yes	0.39	BDH115
1, 3R, 12	IP65	Metal	4.9/145	OFF/ON/TEST	—	Yes	1.50	BDZX74

— = No

Shafts

For use with:	Length (inches/mm)	Description	Weight (lbs.)	Catalog number
CFD30J3S & CFD30CC3S	6.7/170	0.20 x 0.20" (5 x 5mm)	0.08	CDS67P
CFD60J3S & CFD100J3S	8.3/210	0.24 x 0.24" (6 x 6mm)	0.13	BDS210
FD200J3-S & FD400J3-S	12.8/325	0.47 x 0.47" (12 x 12mm)	0.90	BDS325

Terminal lug kit

For use on:	Wire size	Kit weight (lbs)	Wire type	Lugs per kit	Catalog number
CFD30J3S & CFD30CC3S CFD60J3S	#14 – 4	—	Cu	—	Integral
	#14 – 4	—	Cu	—	Integral
CFD100J3S	#14 – 2/0	0.43	Cu/Al	6	BDTL24
FD200J3-S	#6 – 300 kcmil	0.93	Cu/Al	6	BDTL25
FD400J3-S	#2 – 600 kcmil	3.50	Cu/Al	6	BDTL26

① J type fuse clips are standard. If 600V Type "T" fuse clips are desired, please order the "T" type fuse adapter kit.

30A – 100A

UL Fuse Class J, CC, T

For a complete assembly, please select one of each:

- 1 switch
- 1 handle
- 1 shaft
- 1 terminal lug

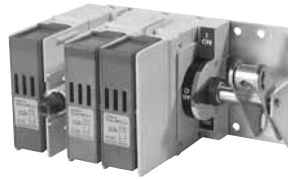

CFD30J3F



BDFHS12



BDFHNHS12

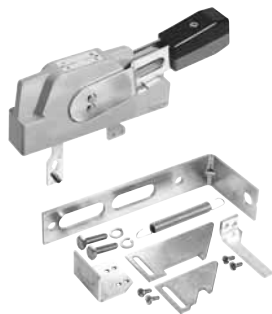

BDFHNHS_



BDFHS_



BDTL24

UL Listed
CSA Approved
IEC Rated
CE Marked

Flange operated switches — 3 pole

UL general purpose amp rating	UL fuse type 600V	Maximum horsepower rating					Weight (lbs)	Catalog number
		Three phase						
		200V	208V	240V	480V	600V		
30	J	5	7.5	7.5	15	20	2.20	CFD30J3F
30	CC	5	7.5	7.5	15	20	2.50	CFD30CC3F
60	J	15	15	15	30	50	3.52	CFD60J3F
100	J [ⓐ]	25	25	30	60	75	3.97	CFD100J3F

Handles

NEMA type	Color	Length inches/mm	Marking	Defeatable	Padlockable	Weight (lbs)	Catalog number
1, 3R, 12	Metal	6.9/175	O/I & OFF/ON	Yes	Yes	3.52	BDFHNHS12
4, 4X	Metal	6.9/175	O/I & OFF/ON	Yes	Yes	3.52	BDFHNHS4

Shafts

Shaft length inches	Mounting depth in inches	Weight (lbs)	Catalog number
12		0.39	BDFHS12
17		0.55	BDFHS17
22.5		0.73	BDFHS22

Terminal lug kit

For use on:	Wire size	Kit weight (lbs)	Wire type	Lugs per kit	Catalog number
BDCF30J6_ & BDFLF60J6-F	#14 – #4	—	Cu	—	Standard
BDFLF100J6-F	#14 – #4	—	Cu	—	Standard
	#14 – 2/0	0.43	Cu/Al	6	BDTL24

Door hardware — NEMA 12

Item	Weight (lbs)	Catalog number
Safety door latch, 2 point with 6" handle	1.92	BDDHK
Roller for 3 point latch, add to FH-DHK	0.39	BD3RL

[ⓐ] J type fuse clips are standard. If 600V Type "T" fuse clips are desired, please order the "T" type fuse adapter kit.

for Fusible Disconnect Switches
CFD30CC3 – FD800L3

UL & CSA

Catalog number	3 pole	CFD30_3	CFD60J3	CFD100J3	FD200J3	FD400J3	FD600J3	FD800L3
Approvals ^①	2 pole 3 pole 4 pole	N/A UL98 & IEC UL98 & IEC	N/A UL98 & IEC UL98 & IEC	UL98 & IEC UL98 & IEC UL98 & IEC	UL98 & IEC UL98 & IEC UL98 & IEC	UL98 & IEC UL98 & IEC UL98 & IEC	UL98 & IEC UL98 & IEC UL98 & IEC	UL98 & IEC UL98 & IEC UL98 & IEC
Technical ratings	-40° to 40°C							
General purpose amp rating pf = 0.7 – 0.8	A	30	60	100	200	400	600	800
Max operating voltage	V	600	600	600	600	600	600	600
Max horsepower rating/ Max motor FLA current pf = 0.4 – 0.5								
Three phase								
200 – 208V	HP/A	5/16.8 – 7.5/24.2	15/46.2	25/75.0	50/143.0	100/273 – 125/344	150/396	200/528
240V	HP/A	7.5/22.0	15/42.0	30/80.0	60/145.0	125/312.0	200/480.0	250/602.0
480V	HP/A	15/21.0	30/40.0	60/77.0	120/156.0	250/302.0	400/477.0	500/590.0
600V	HP/A	20/22.0	50/52.0	75/77.0	150/144.0	350/336.0	500/472.0	600/ —
Single phase								
120V	HP/A	2/24.0	—	—	—	—	—	—
240V	HP/A	3/17.0	—	—	—	—	—	—
Short circuit rating with fuse	kA	200	200	200	200	200	200	200
UL Fuse size	A	30	60	100	200	400	600	800
UL Fuse type		J/CC	J	J/T	J/T	J/T	J/T	L
Endurances								
Min. Electrical endurance, pf = 0.75 – 0.80	operation cycles	6000	6000	6000	6000	1000	1000	500
Mechanical endurance	operation	20,000	20,000	20,000	16,000	12,000	10,000	7000
Physical characteristics								
Weight	3 pole lb 4 pole lb	1.54 1.98	2.86 3.52	3.30 3.96	15.21 17.4	17.2 19.4	37.48 46.3	37.48 46.3
Dimension	3 pole H in W in D in	3.82 4.17 4.21	3.94 5.63 5.04	5.66 7.06 5.09	7.87 10.31 7.83	7.87 11.22 8.11	11.42 14.69 9.21	11.42 14.69 9.21
Shaft size square □	in mm	.20 x 2.0 5 x 5	.24 x .24 6 x 6	.24 x .24 6 x 6	.47 x .47 12 x 12	.47 x .47 12 x 12	.47 x .47 12 x 12	.47 x .47 12 x 12
Switch operating torque for rotary 3 pole switches	lb. in.	26.6	35.5	70.9	195	195	248	248
Terminal lug kits								
Wire range	AWG	Integral #18 – 8	Integral #14 – 4	BDTL24 #14 – 2/0	BDTL25 #6 – 300kcmil	BDTL26 #2 – 600kcmil	BDTL27 (2) #2 – 600 kcmil	BDTL27 (2) #2 – 600 kcmil
Torque:								
Wire tightening	lb. in.	17	30	120	375	500	375	375
Lug mounting	lb. in.	N/A	N/A	50	230	480	500	480
Auxiliary contacts								
NEMA ratings, AC		—	A600	A600	A600	A600	A600	A600
AC rated voltage	VAC	250	600	600	600	600	600	600
AC thermal rated current	A	6	10	10	10	10	10	10
AC maximum volt ampere making	VA	—	7200	7200	7200	7200	7200	7200
AC maximum volt ampere breaking	VA	—	720	720	720	720	720	720
NEMA ratings, DC		—	P300	R300	P600	P600	P600	P600
DC rated voltage	VDC	—	300	300	600	600	600	600
DC thermal rated current	A	—	1	1	5	5	5	5
DC maximum make break current	A	—	28	28	138	138	138	138
Torque:								
Wire tightening	lb. in.	7	7	7	7	7	7	7
Wire range	AWG	#22 – 14/#18 – 14	#18 – 14	#22 – 14	#22 – 14	#22 – 14	#22 – 14	#22 – 14

① The following UL Listed switches are also CSA approved.
② Terminal torques are 35lb. in. for wire sizes #14 – #10 and 45lb. in for wire sizes #8 – #4.

for Fusible Disconnect Switches
CFD30CC3 – FD800L3

IEC

Catalog number	3 pole	CFD30_3	CFD60J3	CFD100J3	FD200J3	FD400J3	FD600J3	FD800L3
Technical ratings	-40° to 40°C							
Rated insulation voltage ^①		1000	1000	1000	1000	1000	1000	1000
Pollution degree 3 ^②	V							
Dielectric strength 50Hz/60Hz, 1 min	kV	10	10	10	10	10	10	10
Rated impulse withstand voltage	kV	12	12	12	12	12	12	12
Rated thermal current, I _{th} /max. fuse power dissipation ^③								
AC 20/DC 20 open ^④	A/W	32/3.5	63/7.5	160/12	200/22	400/45	630/60	800/65
40°C enclosed	A/W	32/3.5	63/7.5	160/10, 135/12	200/22	400/34, 360/37	600/45, 570/50	720/55
Enclosed with solid links	A/W	32	85	175	280	450	700	900
with minimum cable cross section Cu	mm ²	6	16	70	95	240	2 x 185	2 x 240
Rated operational voltage AC 20 and DC 20V		1000	1000	1000	1000	1000	1000	1000
AC Rated operational currents								
AC 21A	≤500V A	32	63	160	200	400	630	800
	≤690V A	32	63	160	200	400	630	800
AC 22A	≤500V A	32	63	160	200	400	630	800
	≤690V A	32	63	160	200	400	630	800
AC 23A	≤500V A	32	63	160	200	400	630	720
	≤690V A	32	63 ^⑤	160 ^⑥	200	400	630	720
DC Rated operational currents/poles in series								
DC21A	48V ^⑦ A	32/2	⊙	⊙	200/2	400/2	630/2	800/2
	110V A	32/2	⊙	⊙	200/2	400/2	630/2	800/2
	220V A	32/2	⊙	⊙	200/2	400/2	630/2	800/2
	440V A	32/4	⊙	⊙	200/2	400/2	630/2	800/2
	750V A	—	⊙	⊙	200/3	400/3	630/1	800/3
	1000V A	—	⊙	⊙	200/4	400/4	630	800/4
DC22A	48V ^⑦ A	32/2	⊙	⊙	200/2	400/2	630/2	800/2
	110V A	32/2	⊙	⊙	200/2	400/2	630/2	800/2
	220V A	32/2	⊙	⊙	200/2	400/2	630/2	800/2
	440V A	32/4	⊙	⊙	200/2	400/2	630/2	800/2
	750V A	—	⊙	⊙	200/3	400/3	630/3	800/3
	1000V A	—	⊙	⊙	200/4	400/4	630/4	800/4
DC23A	48V ^⑦ A	32/2	⊙	⊙	200/2	400/2	630/2	800/2
	110V A	32/2	⊙	⊙	200/2	400/2	630/2	800/2
	220V A	32/2	⊙	⊙	200/2	400/2	630/2	800/2
	440V A	32/4	⊙	⊙	200/2	400/2	630/2	800/2
	750V A	—	⊙	⊙	200/3	400/3	630/3	800/3
	1000V A	—	⊙	⊙	—	—	630/4	800/4
Rated operational power AC23A								
230V	kW	8	18.5	45	57	110	180	200
400V	kW	14	30	80	100	210	315	350
415V	kW	15	30	90	110	230	340	380
500V	kW	18	37	110	140	280	400	470
690V	kW	25	60	132	180	330	540	600

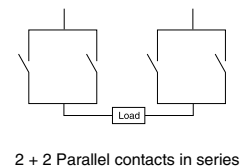
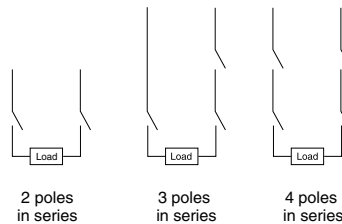

① 1000V, IEC 408.
 ② Ambient temperature 60°C: derating 20 percent. Mounting on ceiling: derating 10 percent. Mounting on wall, horizontal fuses: derating 8 percent.
 ③ The ambient air temperature does not exceed +40°C and its average over a period of 24h does not exceed +35°C according to IEC 947.
 ④ For 30A switches, use 2 parallel contacts in series.
 ⑤ Available on request.
 ⑥ IEC 947-3, utilization category B, infrequent operation.
 ⑦ Rated conditional short-circuit current RMS and corresponding max. allowed cut-off current, peak-values.
 – Fuse cut-off currents refer to single-phase fuse tests.
 – Fuse selection tables on request.
 ⑧ Pollution degree 3: Conductive pollution occurs, or dry, non-conductive pollution occurs, which becomes conductive due to condensation.

Fusible

Non-Fused

Enclosed Fused

Enclosed Non-Fused

for Fusible Disconnect Switches

CFD30CC3 – FD800L3

IEC

Catalog number	3 pole	CFD30_3	CFD60J3	CFD100J3	FD200J3	FD400J3	FD600J3	FD800L3	
Rated breaking capacity									
in category AC-23A	500V	A	256	504	1280	2000	3200	5760	5760
	690V	A	256	504	1280	2000	3200	5760	5760
Rated breaking capacity/poles in series									
in category DC-23	<220V	A	128/2	—	—	1000/2	1600/2	3200/2	3200/2
	440V	A	128/4	—	—	1000/2	1600/2	3200/2	3200/2
	500 – 750V	A	—	—	—	1000/3	1600/3	3200/3	3200/3
	1000V	A	—	—	—	—	3200/4	3200/4	3200/4
Rated conditional short-circuit current r.m.s. ^①									
	80 kA, 415V	kA	9	17	22	40	40	75	75
	100 kA, 500 V	kA	7.5	17	22	40	40	75	75
	50 kA, 690 V	kA	6	13	15	35	35	60	60
Rated short time withstand current, 1s. kA									
		kA	1	2.5	5	8	10	16	16
Rated capacitor power									
– The capacitor rating of the fusible disconnect switch is limited by the fuse link									
	400 V	kVar	15	30	—	90	180	250	310
	415V	kVar	15	32	—	100	200	270	340
	690V	kVar	25	50	—	160	325	450	550
Power loss/pole									
with rated current, without fuse	W		2	4	9	5	30	55	77
Mechanical endurance operations									
			20,000	20,000	20,000	16,000	16,000	10,000	10,000
Fuse types, IEC 269-2									
	DIN 43620		—	000, 00	000, 00	0 – 1	0 – 2	3	3
	NFC	10 x 38, 14 x 51	14 x 51, 22 x 58	22 x 58	0 – 1	0 – 2	3	—	—
	BS 88	A1, A2, F1	A2 – A3	A2 – A4	B1 – B3	B1 – B4	C1 – C2	C1 – C3	C1 – C3
size/distance of link bolts									
		M4/44.5(A1) M5/73(A2)	M5/73	M5/73 M8/94	M8/111	M3/111	M10/133, 184	M10/133, 184	
Physical characteristics									
Weight	3 pole		0.7	1.3	1.5	6.9	7.8	17.0	17.0
	4 pole		0.9	1.6	1.8	7.9	8.8	21.0	21.0
Dimension	3 pole	H	97	100	144	200	226	282	282
		W mm	106	174	179	260	284	373	373
		D mm	107	123	129	184	198	221	221
Shaft size	square	□ mm	5 x 5	6 x 6	6 x 6	12 x 12	12 x 12	12 x 12	12 x 12
Terminals									
Built-in terminal size mm ²									
			0.5 – 10	2.5 – 25	—	—	—	—	—
Terminal bolt size, metric thread									
	diameter x length	mm	—	—	M6 x 20	M10 x 40	M10 x 40	M12 x 40	M12 x 40
Terminal bolt tightening torque									
	Nm		2	3.5	6 – 9	30 – 44	30 – 44	50 – 75	50 – 75
Fuse-links bolts tightening torque									
	Nm		2	3.5	3.5 – 5	15	15	40	40
Operating torque									
	Nm		3	4	8	22	22	28	28
Auxiliary contacts									
Ratings according to IEC 947-5-1									
Rated voltage, Ui	VAC	①	690	690	690	690	690	690	690
Thermal current, Ith	A	②	10	16	16	10	10	10	10
AC12 / DC12, Ie	Ue=	③	— / 6	—	—	—	—	—	—
	24V	A	— / 6	—	—	8 / —	8 / —	8 / —	8 / —
	120V	A	— / 6	—	—	— / 1.1	— / 1.1	— / 1.1	— / 1.1
	125V	A	—	—	—	6 / —	6 / —	6 / —	6 / —
	230V	A	—	6 / —	6 / —	— / 0.55	— / 0.55	— / 0.55	— / 0.55
	250V	A	3 / 0.1	—	—	4 / —	4 / —	4 / —	4 / —
	400V	A	—	4 / —	4 / —	4 / —	4 / —	4 / —	4 / —
	415V	A	—	—	—	4 / —	4 / —	4 / —	4 / —
	440V	A	2 / —	—	—	— / 0.31	— / 0.31	— / 0.31	— / 0.31
	480V	A	—	—	—	3 / —	3 / —	3 / —	3 / —
	500V	A	—	—	—	3 / 0.27	3 / 0.27	3 / 0.27	3 / 0.27
	600V	A	—	—	—	— / 0.2	— / 0.2	— / 0.2	— / 0.2
	690V	A	—	2 / —	2 / —	2 / —	2 / —	2 / —	2 / —

① AC15 / DC12, according to IEC 947-5-1

② AC15 / DC13, according to IEC 947-5-1

③ AC15, according to IEC 947-5-1

④ AC11 / DC11, according to IEC 947-5-1

⑤ Values shown are corresponding max. allowed cut-off current, peak-values per single phase fuse tests.

for Fusible Disconnect Switches
CFD30J3 - CFD60J3

CFD30J3 & CFD30CC3

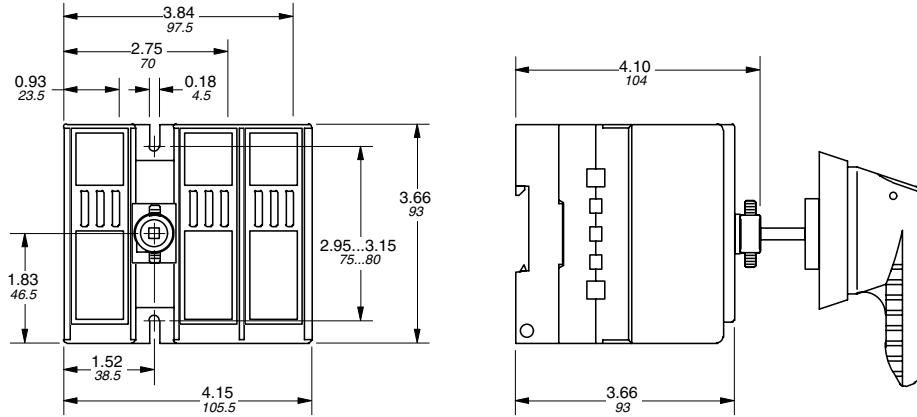

CFD60J3

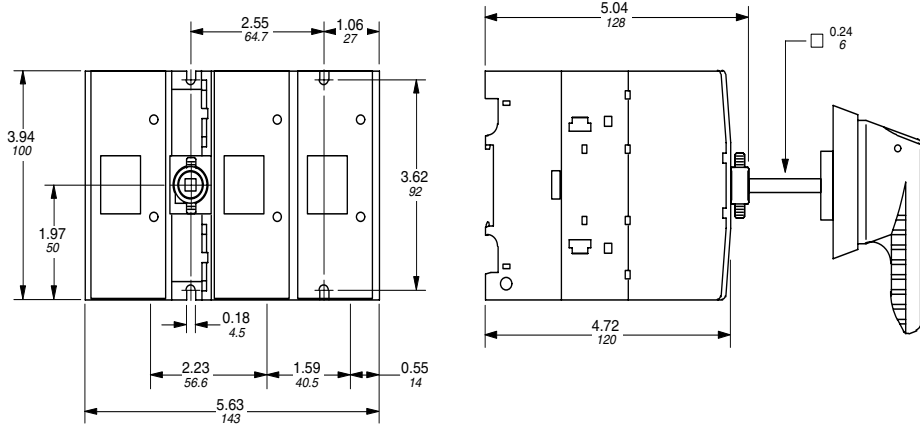

Fusible

Non-Fused

Enclosed Fused

Enclosed Non-Fused

for Fusible Disconnect Switches
CFD100J3 - FD200J3

CFD100J3

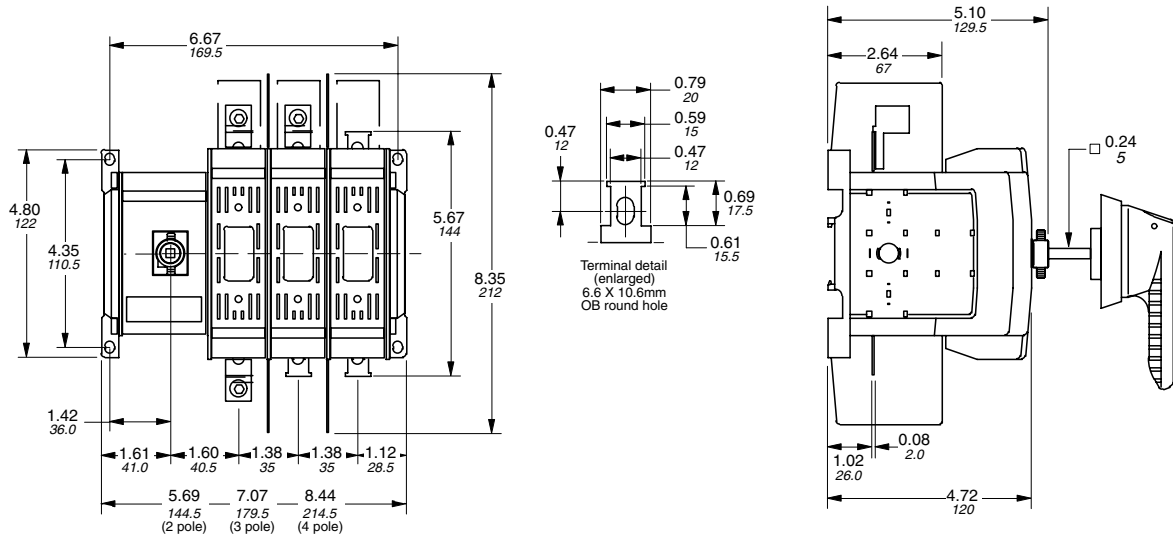

Fusible

Non-Fused

FD200J3

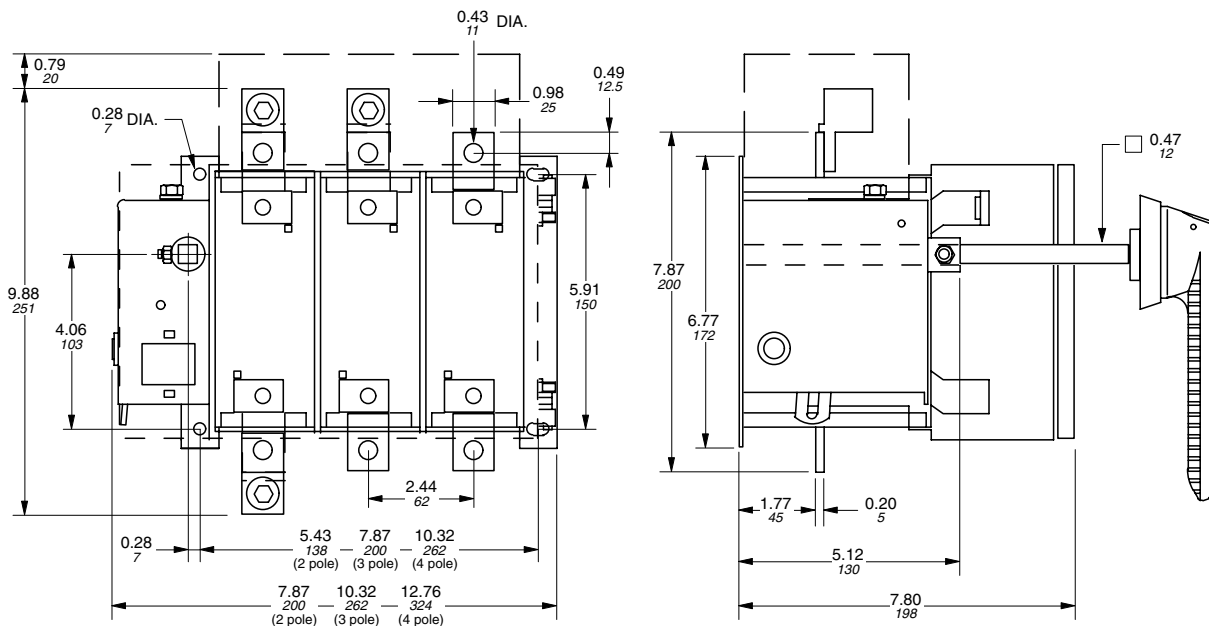

Enclosed Fused

Enclosed Non-Fused

for Fusible Disconnect Switches
FD400J3 - FD800J3

FD400J3

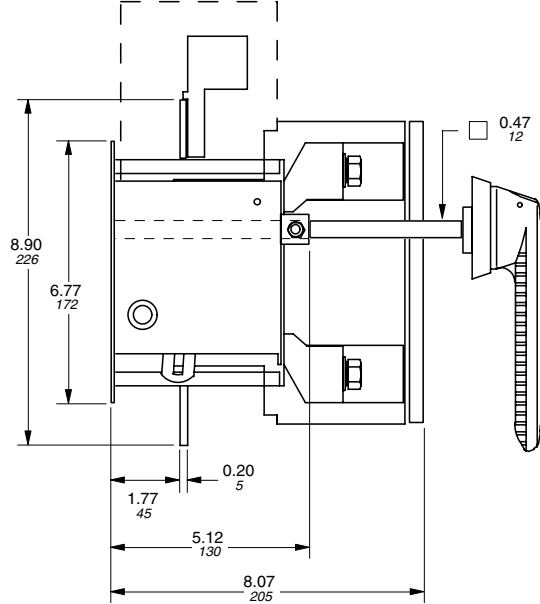
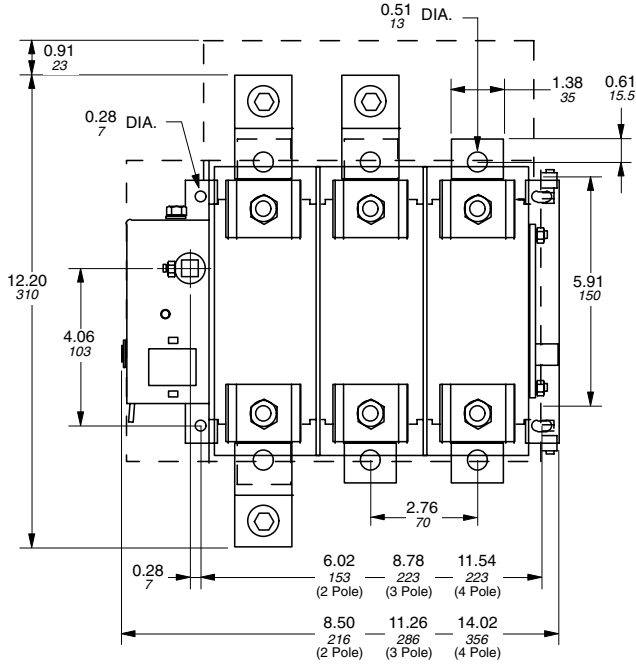

FD600J3 & FD800L3

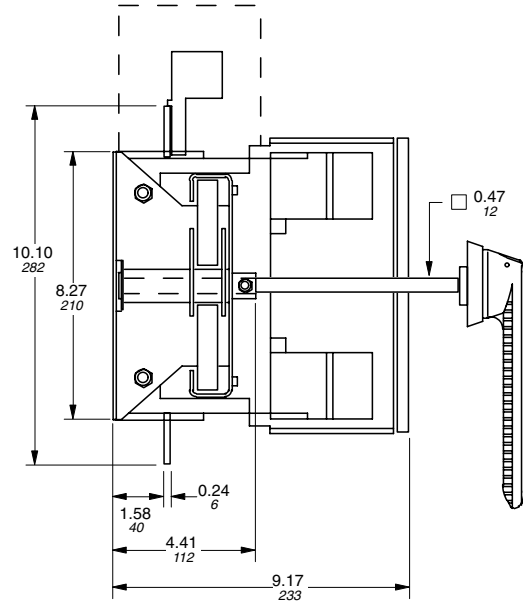
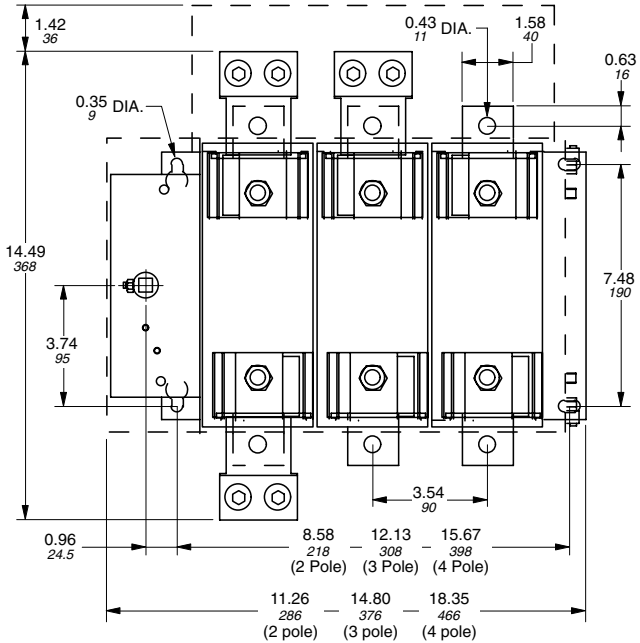

Fusible

Non-Fused

Enclosed Fused

Enclosed Non-Fused

Approximate Dimensions for Terminal Lugs

Bussmann®

BDTL24 — for use with 100A switches

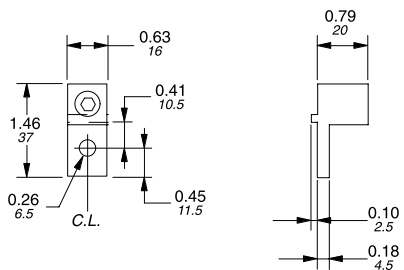

BDTL26 — for use with 400A switches

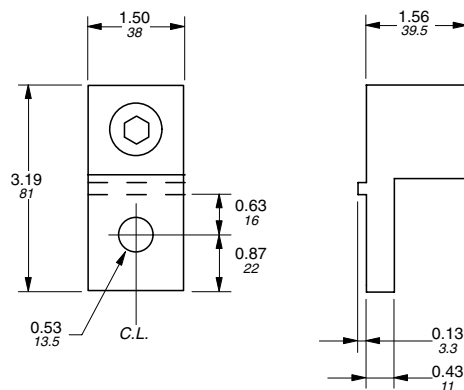

BDTL25 — for use with 200A switches

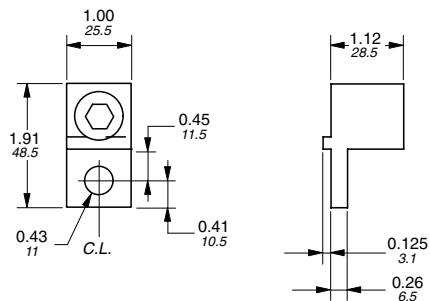

BDTL27 — for use with 600A switches

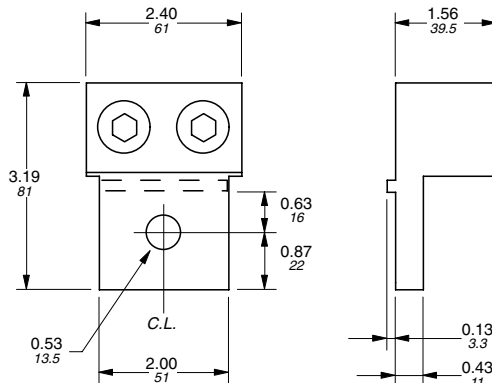

BDTL175 — power distribution lug, for 200A switch

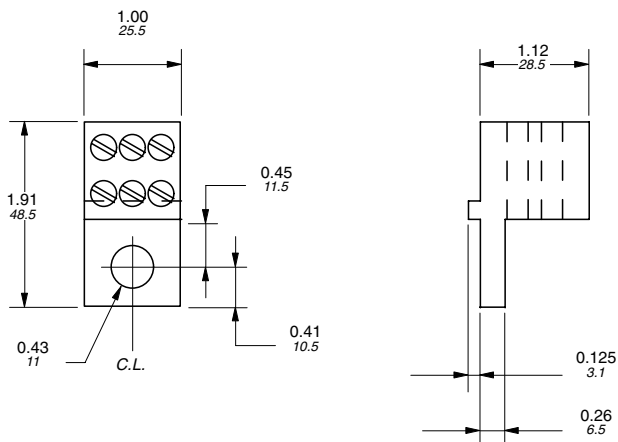

BDTL175/400 —

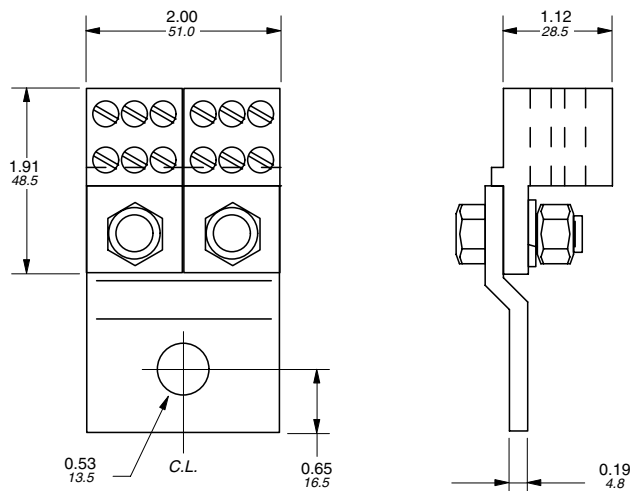

Fusible

Non-Fused

Enclosed Fused

Enclosed Non-Fused

Approximate Dimensions for 30A Conversion Mechanisms

Bussmann®

6 pole — BDZW5

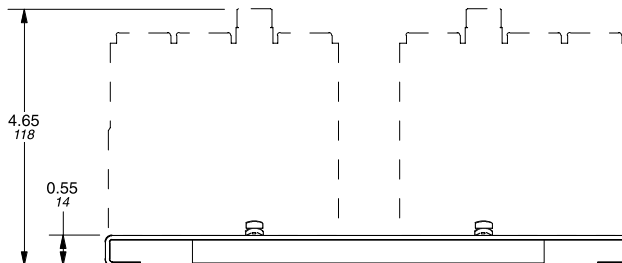
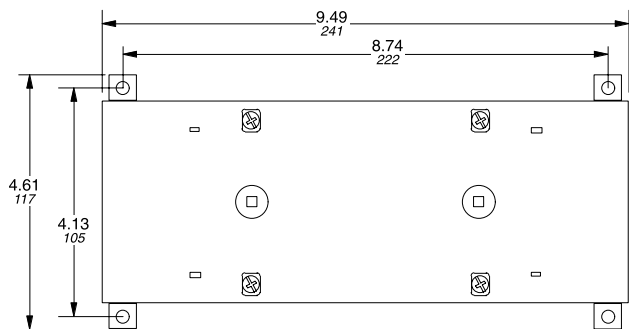

3 pole transfer switch — BDZW30

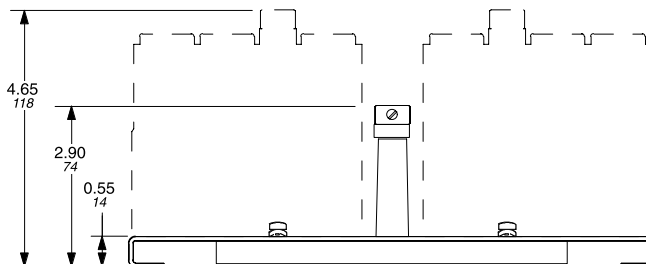
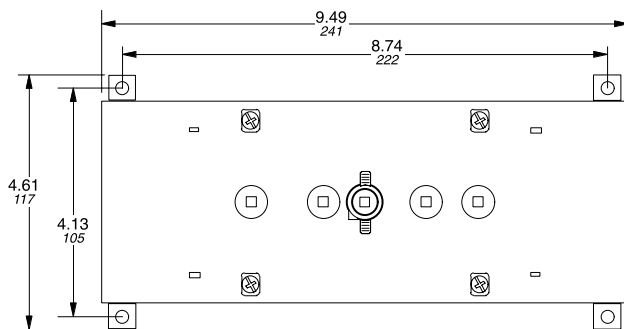

Mechanical interlock — BDZW4

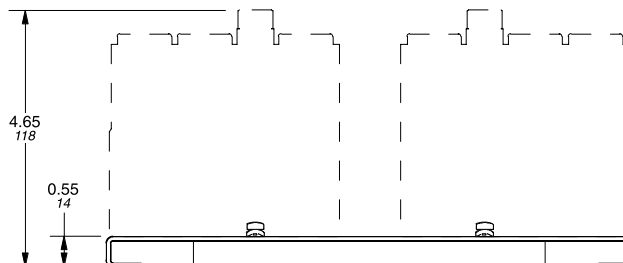
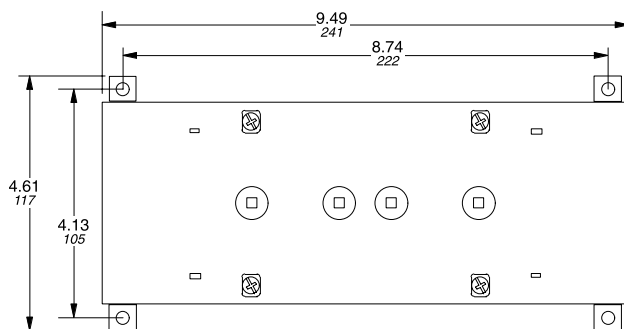

Fusible

Non-Fused

Enclosed Fused

Enclosed Non-Fused

for 60A – 100A Conversion Mechanisms

6 or 8 pole — BDZW2

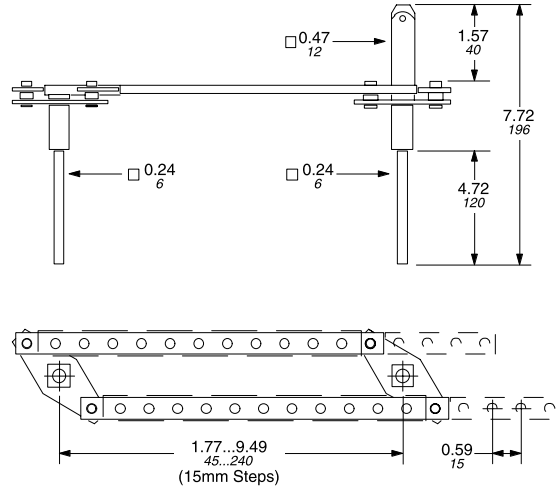

Transfer switch — BDZW1

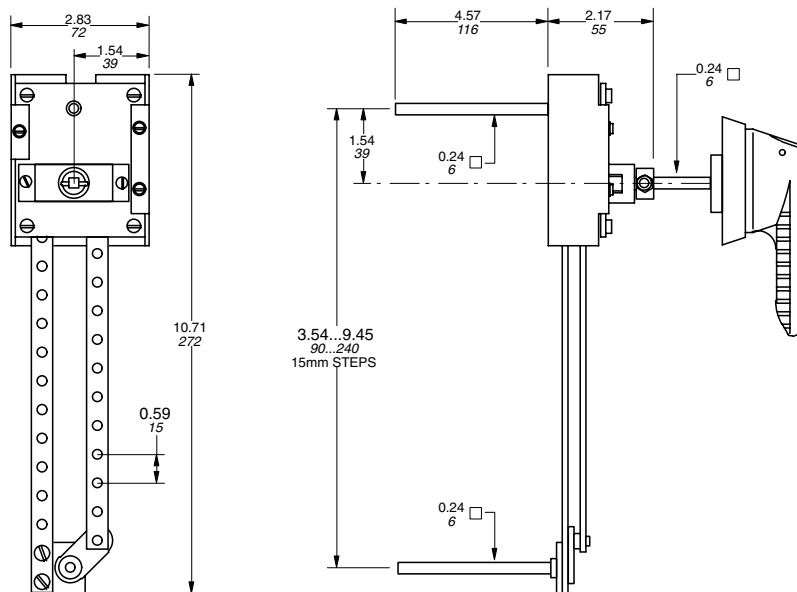

Fusible

Non-Fused

Enclosed Fused

Enclosed Non-Fused

for 200A – 800A Conversion Mechanisms

6 or 8 pole — BDZW9

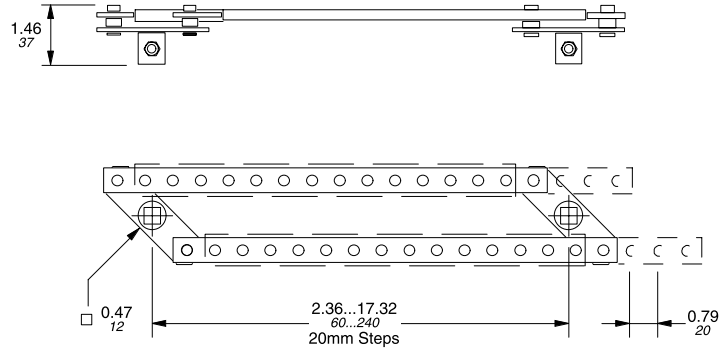

Transfer switch — BDZW12

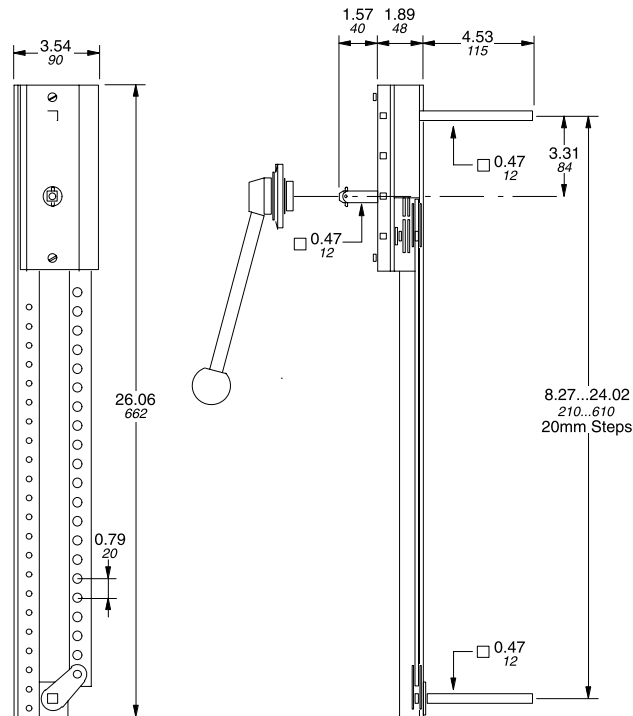

Fusible

Non-Fused

Enclosed Fused

Enclosed Non-Fused

for Non-Fusible Disconnect Switches

CDNF16 – CDFN160



CDNF16 CDFN25 CDFN32



CDNF30 CDFN60 CDFN100



CDNF160

Catalog number	3 pole	CDNF16	CDNF25	CDNF32	CDNF45	CDNF63	CDNF30	CDNF60	CDNF100	CDNF160
General purpose amp rating	A	16	25	40	60	80	30	60	100	125
Approvals ^①	2 pole 3 pole 4 pole	N/A UL508 UL508	N/A UL508 UL508	N/A UL508 UL508	N/A UL508 UL508	N/A UL508 UL508	N/A UL98 UL98	N/A UL98 UL98	N/A UL98 UL98	UL98 UL98 UL98
Technical ratings										
UL, CSA^②										
Max operating voltage	V	600	600	600	600	600	600	600	600	600
Max horsepower rating										
Three phase										
200 – 208V	HP	3	7.5	10	15	20	10	20	25	—
240V	HP	5	7.5	10	15	20	10	20	30	30
480V	HP	10	15	20	30	40	20	40	50	60
600V	HP	10	20	25	30	40	30	40	50	75
Single phase										
120V	HP	1/2	3/4	1	2	2	2	3	5	7.5
240V	HP	1.5	2	3	5	5	5	7.5	15	20
Technical ratings										
IEC^③										
Rated insulation and operational voltage. AC20 and DC20 ^④	V	750	750	750	750	750	750	750	750	750
Rated thermal current, I _n										
AC 20/DC 20 open	A	25	32	40	63	80	40	63	115	200
AC 20/DC 20 enclosed	A	25	32	40	63	80	40	63	115	160
AC 21A 500V	A	16	25	32	63	80	40	63	100	160
690V	A	16	25	32	63	80	40	63	100	160
Rated operational power AC23										
400/415V	kW	7.5	9	11	22	37	15	18.5	37	75
690V	kW	7.5	9	11	15	18.5	15	15	37	75
Physical characteristics										
Weight ^④	3 pole lb	0.24	0.24	0.24	0.59	0.59	0.79	0.79	0.79	2.42
Dimension	3 pole H in	2.68	2.68	2.68	3.60	3.60	3.94	3.94	3.94	5.00
	W in	1.38	1.38	1.38	2.07	2.07	2.76	2.76	2.76	4.96
	D in	2.20	2.20	2.20	2.85	2.85	2.95	2.95	2.95	2.93
Accessories										
Terminal lug kit		Integral	Integral	Integral	Integral	Integral	Integral	Integral	Integral	integral
Terminal shroud		•	•	•	•	•	•	•	•	•
Auxiliary contact		•	•	•	•	•	•	•	•	•
Handle UL/NEMA type										
Type 1, 3R, 12		•	•	•	•	•	•	•	•	•
Type 1, 3R, 4, 4X, 12		•	•	•	•	•	•	•	•	•
Handle type										
Selector		•	•	•	•	•	—	—	—	—
Pistol		•	•	•	•	•	•	•	•	•
Conversion kits										
6 pole		•	•	•	•	•	•	•	•	•
Transfer		•	•	•	•	•	•	•	•	•
Bypass		•	•	•	•	•	•	•	•	•
Mechanical interlock		•	•	•	•	•	•	•	•	•
Electrical interlock		—	—	—	—	—	—	—	—	—

• = Available
— = Not available

UL listed, CSA approved, IEC rated, CE marked

- ① UL listed switches are also CSA approved.
- ② For complete technical information please see page 58 & 59.
- ③ 1000V, IEC 408.
- ④ Switch only

Fusible

Non-Fused

Enclosed Fused

Enclosed Non-Fused

for Non-Fusible Disconnect Switches

BDNF200A – BDNF3150

Fusible

Non-Fused

Enclosed Fused

Enclosed Non-Fused

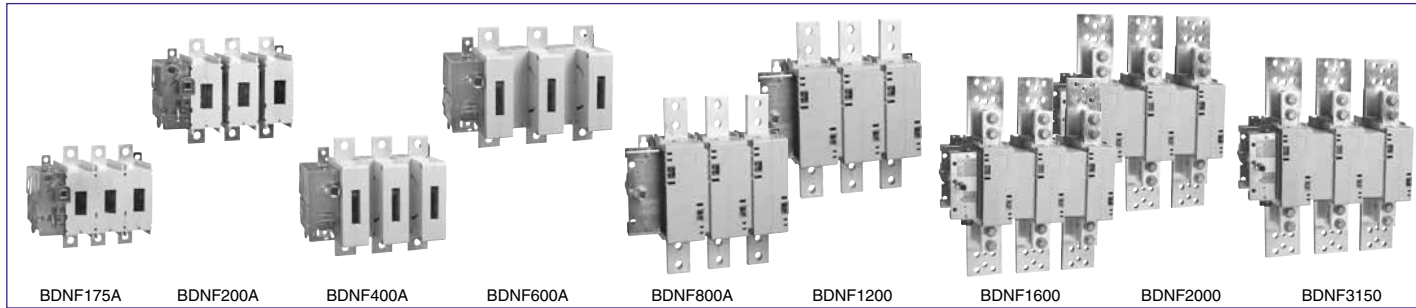

Catalog number	3 pole	BDNF175A	BDNF200A	BDNF400	BDNF600A	BDNF800A	BDNF1200	BDNF1600	BDNF2000	BDNF3150
General purpose amp rating	A	175	200	400	600	800	1200	1600	2000	3150
Approvals ^①										
	2 pole	UL508 & IEC	UL98 & IEC	UL98 & IEC	UL98 & IEC	UL98 & IEC	UL98 & IEC	UL98 & IEC	UL98 & IEC	IEC
	3 pole	UL508 & IEC	UL98 & IEC	UL98 & IEC	UL98 & IEC	UL98 & IEC	UL98 & IEC	UL98 & IEC	UL98 & IEC	IEC
	4 pole	IEC	IEC	UL98 & IEC	UL98 & IEC	IEC	IEC	IEC	IEC	IEC
Technical ratings										
UL, CSA^②										
Max operating voltage	V	600	600	600	600	600	600	600	600	600
Max horsepower rating										
Three phase										
200 – 208V	HP	30	60	100	150	200	—	—	—	—
240V	HP	40	75	125	200	250	—	—	—	—
480V	HP	75	150	250	400	500	—	—	—	—
600V	HP	100	200	350	500	600	—	—	—	—
Single phase										
120V	HP	—	—	—	—	—	—	—	—	—
240V	HP	—	—	—	—	—	—	—	—	—
Technical ratings										
IEC^③										
Rated insulation and operational voltage. AC20 and DC20 ^④	V	1000	1000	1000	1000	1000	1000	1000	1000	1000
Rated thermal current, I _{th}										
AC 20/DC 20 open	A	200	315	630	800	1250	1600	2500	2500	3150
AC 20/DC 20 enclosed	A	200	270	630	720	1250	1600	2300	2300	2600
AC 21A 500V	A	200	250	630	800	1250	1600	2500	2500	3150
AC 21A 690V	A	200	250	630	800	1250	1600	2500	2500	3150
Rated operational power AC23										
400/415V	kW	90	132	315	355	400	400	400	400	400
690V	kW	170	200	355	355	—	—	—	—	—
Physical characteristics										
Weight ^④	3 pole lb	6.61	6.61	13.66	13.66	35.9	38.55	127.7	127.7	127.7
Dimension	3 pole									
	H in	8.35	8.35	11.81	11.77	19.09	19.09	25.04	25.04	25.04
	W in	7.83	8.62	10.24	11.93	14.29	14.29	18.43	18.43	18.43
	D in	4.55	4.55	5.12	5.12	4.92	4.92	10.67	10.67	10.67
Accessories										
Terminal lug kit		BDTL25	BDTL25	BDTL26	BDTL27	BDTL30	BDTL28	BDTL28	BDTL28/2	BDTL28/2
Terminal shroud		•	•	•	•	•	•	—	—	—
Auxiliary contact		•	•	•	•	•	•	•	•	•
Handle UL/NEMA type										
Type 1, 3R, 12		•	•	•	•	•	•	•	•	•
Type 1, 3R, 4, 4X, 12		•	•	•	•	•	•	•	•	•
Handle type										
Selector		—	—	—	—	—	—	—	—	—
Pistol		•	•	•	•	•	•	•	•	•
Conversion kits										
6 pole		•	•	•	•	•	•	—	—	—
Transfer		•	•	•	•	•	•	—	—	—
Bypass		•	•	•	•	•	•	—	—	—
Mechanical interlock		•	•	•	•	•	•	•	•	•
Electrical interlock		•	•	•	•	•	•	•	•	•

S = Standard feature
 • = Available
 — = Not available

UL listed, CSA approved, IEC rated, CE marked

① UL listed switches are also CSA approved.
 ② For complete technical information please see page 58 & 59.
 ③ 1000V, IEC 408.
 ④ Switch only

for Non-Fusible Disconnect Switches

Base & DIN Rail Mounted

For a complete assembly, please select one of each:

- 1 switch
- 1 handle
- 1 shaft



CDNF63



CDS85S



CDH3S

16 – 100 Amp switches, 600V, 3 pole^①

UL general purpose amp rating	IEC AC21 amp rating	Maximum horsepower rating						Terminal lugs		Catalog number
		Single phase		Three phase				Wire size	Wire type	
		120V	240V	200V	240V	480V	600V			
16	16	1/2	1.5	3	5	10	10	#18 – 8	Cu	CDNF16
25	25	3/4	2	7.5	7.5	15	20	#18 – 8	Cu	CDNF25
40	40	1	3	10	10	20	25	#18 – 8	Cu	CDNF32
60	63	2	5	15	15	30	30	#14 – 4	Cu	CDNF45
80	80	2	5	20	20	40	40	#14 – 1	Cu	CDNF63
30	40	2	5	10	10	20	30	#14 – 4	Cu	CDNF30
60	63	3	7.5	20	20	40	40	#14 – 4	Cu	CDNF60
100	115	5	15	25	30	50	50	#8 – 1/0	Cu	CDNF100

Selector handles — for use with shafts $\square .20 \times .20"$ ($\square 5 \times 5 \text{mm}$)

NEMA type	IEC type	Color	Defeatable	Padlockable	Weight (lbs)	Catalog number
All marked both O/I & Off/On						
1	IP54	Black	—	—	0.09	CDH1S ^②
1	IP54	Red/Yel	—	—	0.09	CDH2S ^②
1	IP54	Black	—	Yes	0.12	CDH15S ^②
1	IP54	Red/Yel	—	Yes	0.12	CDH16S ^②
1,3R,12	IP65	Black	—	Yes	0.16	CDH3S
1,3R,12	IP65	Red/Yel	—	Yes	0.16	CDH4S
1,3R,12	IP65	Black	Yes	Yes	0.16	CDH5S
1,3R,12	IP65	Red/Yel	Yes	Yes	0.16	CDH6S

Shafts — for use with CDH selector handles $\square .20 \times .20"$ ($\square 5 \times 5 \text{mm}$)



Shaft length inches/mm	Mounting depth ^③ in inches					Weight (lbs)	Catalog number
	CDNF16 CDNF25 CDNF32		CDNF45 CDNF63		CDNF30 CDNF60 CDNF100		
	CDH1S, CDH2S CDH15S, CDH16S	CDH3S, CDH4S CDH5S, CDH6S	CDH1S, CDH2S CDH15S, CDH16S	CDH3S, CDH4S CDH5S, CDH6S	CDH3S, CDH4S CDH5S, CDH6S		
3.3/85	4.2 – 5.0	3.6 – 4.3	4.9 – 5.6	4.4 – 5.0	3.9 – 4.9	0.04	CDS85S
4.1/105	5.0 – 5.8	4.4 – 5.1	5.7 – 6.4	5.1 – 5.8	4.7 – 5.7	0.04	CDS105S
4.7/120	5.6 – 6.4	5.0 – 5.8	6.3 – 7.0	5.7 – 6.4	5.3 – 6.3	0.05	CDS120S
5.1/130	6.0 – 6.7	5.4 – 6.1	6.7 – 7.4	6.1 – 6.8	5.6 – 6.7	0.05	CDS130S
7.1/180	7.1 – 8.7	7.4 – 8.1	8.6 – 9.4	8.1 – 8.7	7.6 – 8.6	0.08	CDS180S
9.8/250	10.7 – 11.5	10.1 – 10.8	11.4 – 12.1	10.9 – 11.5	10.4 – 11.4	0.10	CDS250S
13/330	13.8 – 14.6	13.3 – 14.0	14.6 – 15.3	14.0 – 14.7	13.5 – 14.5	0.14	CDS330S

① A snap on fourth pole may be added

② Not suitable for use with CDF30, 60, 100.

③ Mounting depth is the distance from the outside of door to the disconnect switch mounting plate. Shaft can be cut to desired length.



CDNF16
CDNF25
CDNF32



CDNF30
CDNF60
CDF100



CDH1S



CDH15S



CDH6S



CDS_S

Fusible

Non-Fused

Enclosed Fused

Enclosed Non-Fused

for 16A – 100A Non-Fusible Disconnect Switches Base & DIN Rail Mounted

Fusible

Non-Fused

Enclosed Fused

Enclosed Non-Fused



BDH104, 6



BDH105



CDS_P

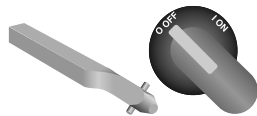

CDS_T



OPMRH



CDBY68306



CDBY68419/1



CDMC1

Pistol handles — for use with shafts $\square .20 \times .20$ " ($\square 5 \times 5$ mm)

NEMA type	IEC type	Color	Marking	Length inches/mm	Defeatable	Padlockable	Weight (lbs.)	Catalog number
1,3R,12	IP65	Black	O/I & Off/On	1.8/45	Yes	Yes	0.28	BDH104
1,3R,12	IP65	Red/Yel	O/I & Off/On	1.8/45	Yes	Yes	0.28	BDH105
1,3R,12	IP65	Black	O/I & Off/On	2.6/65	Yes	Yes	0.29	BDH106
1,3R,12	IP65	Red/Yel	O/I & Off/On	2.6/65	Yes	Yes	0.29	BDH107
1,3R,12,4,4X	IP66	Black	O/I & Off/On	2.6/65	Yes	Yes	0.29	CDHXB65
1,3R,12,4,4X	IP66	Red/Yel	O/I & Off/On	2.6/65	Yes	Yes	0.29	CDHXY65

Shafts — for use with pistol handles $\square .20 \times .20$ " ($\square 5 \times 5$ mm)



Shaft length (inches/mm)	Mounting depth ^① in inches			Weight (lbs.)	Catalog number
	CDNF16 CDNF25 CDNF32	CDNF45 CDNF63	CDNF30 CDNF60 CDNF100		
5.9/150	6.2 – 6.7	6.9 – 7.4	6.4 – 7.4	0.07	CDS48P
6.7/170	7.0 – 7.5	7.7 – 8.1	7.2 – 8.1	0.08	CDS67P
10.4/265	10.7 – 11.3	11.4 – 11.9	10.9 – 11.9	0.12	CDS49P
15.8/400	16.0 – 16.6	16.8 – 17.2	16.2 – 17.2	0.18	CDS50P
19.7/500	20.0 – 20.5	20.7 – 21.1	20.1 – 21.1	0.23	CDS99P

Twisted shafts — Rotates handle 45° $\square .20 \times .20$ " ($\square 5 \times 5$ mm)



Shaft length (inches/mm)	Mounting depth ^① in inches			Weight (lbs.)	Catalog number
	CDNF16 CDNF25 CDNF32	CDNF45 CDNF63	CDNF30 CDNF60 CDNF100		
5.9/150	6.2 – 6.7	6.9 – 7.4	6.4 – 7.4	0.07	CDS48T
6.7/170	7.0 – 7.5	7.7 – 8.1	7.2 – 8.1	0.08	CDS67T
10.4/265	10.7 – 11.3	11.4 – 11.9	10.9 – 11.9	0.12	CDS49T
15.8/400	16.0 – 16.6	16.8 – 17.2	16.2 – 17.2	0.18	CDS50T

Replacement knob — mounts directly to switch; no shaft necessary

NEMA Type	Color	For use on:	Length (inches)	Padlockable	Catalog number
1	Red	CDNF16, 25, 32	1.0	—	OPMRH
1	Red	CDNF30, 45, 60, 63, 100	1.4	—	CDBY68306 ^③
1	Red	CDNF30, 45, 60, 63, 100	1.6	Yes ^②	CDBY68419/1 ^③
Metal collar		CDNF16 – CDNF100	—	—	CDMC1
Set screw		CDNF16, 25, 30, 32, 45, 60, 63, 100	—	—	CDSWM5X8

① Mounting depth is the distance from the outside of door to the disconnect switch mounting plate. Shaft can be cut to desired length.
 ② .1875" (3/16") diameter shackle required.
 ③ Set screw CDSWM5X8 needed with replacement knobs CDBY_.

for 16A – 100A Non-Fusible Disconnect Switches Base & DIN Rail Mounted

Base and DIN rail mounted switches

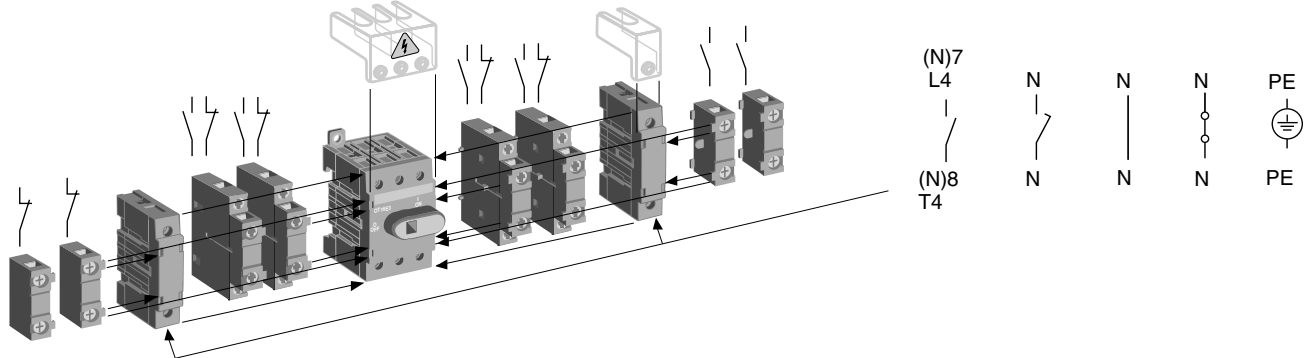

Auxiliary contacts^① — snap-on mounting

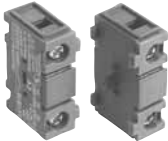

CDAUX_



CDAUX11

Description	For use on:	Weight (lbs.)	AC thermal amp rating	AC rated voltage	Catalog number
1 N.O. mounts on right hand side of switch only	CDNF16 – CDNF100	0.07	10	600	CDAUX10
1 N.C. mounts on left hand side of switch only	CDNF16 – CDNF100	0.07	10	600	CDAUX01
1 N.O. + 1 N.C. mounts on left or right hand side of switch	CDNF16 – CDNF100	0.07	10	600	CDAUX11

Max. two contacts on each side of switch

Power poles

- Only one power pole per switch
- Mounts on left or right side of switch

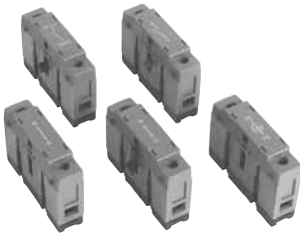

CD_32P

Description	For use on:	Weight (lbs.)	AC thermal amp rating	AC rated voltage	Catalog number
Fourth pole ^②	CDNF16 – CDNF100	0.07	40	600	CDS32P
		0.13	80	600	CDS63P
		0.31	100	600	CDS125P
Late-break/early-make ^②	CDNF16 – CDNF100	0.07	40	600	CDL32P
		0.13	80	600	CDL63P
		0.31	100	600	CDL125P

Terminal poles

- Switch accepts one terminal pole per side
- Mounts on left or right side of switch



CD_63P

Description	For use on:	Weight (lbs.)	AC thermal amp rating	AC rated voltage	Catalog number
Solid neutral ^②	CDNF16 – CDNF100	0.07	40	600	CDN32P
		0.13	80	600	CDN63P
		0.31	100	600	CDN125P
Detachable neutral ^②	CDNF16 – CDNF100	0.07	40	600	CDD32P
		0.13	80	600	CDD63P
		0.31	100	600	CDD125P
Ground terminal ^②	CDNF16 – CDNF100	0.07	40	600	CDE32P
		0.13	80	600	CDE63P
		0.31	100	600	CDE125P

① UL File # E83510

② Switch accepts one power pole or one terminal pole per side. Only one power pole per switch.



CD_125P

Fusible

Non-Fused

Enclosed Fused

Enclosed Non-Fused

for 16A – 100A Non-Fusible Disconnect Switches

Base & DIN Rail Mounted

Fusible

Non-Fused

Enclosed Fused

Enclosed Non-Fused

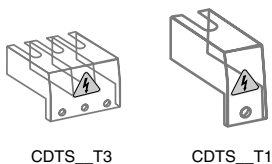

CDTS_T3

CDTS_T1



CDSA1

CDSA2



CDTL-ST

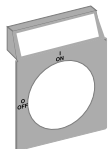

CDP_2

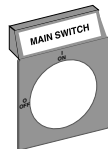

CDP_2EN1

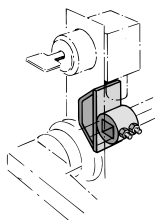

CDETL-ZW16



NDNA100
NDNA200

Terminal shrouds* — snap on mounting for line or load side

Description	For use on:	Weight (lbs.)	Catalog number
3 pole includes one shroud for line or load side	CDNF16, CDNF25, CDNF32,	0.02	CDTS32T3 CDTS63T3 CDTS125T3
	CDNF45, CDNF63,	0.02	
	CDNF30, CDNF60, CDNF100	0.02	
4th pole includes one shroud for line or load side	CD_32P	0.02	CDTS32T1 CDTS63T1 CDTS125T1
	CD_63P	0.02	
	CD_125P	0.02	

* All disconnects are IP20 touch safe as standard. Terminal shrouds provide an additional level of protection.

Padlocking adapter

Description	For use on:	Weight (lbs.)	Catalog number
Adapter for one padlock with a max. 0.137" shackle	CDNF30, CDNF45 CDNF60, CDNF63 CDNF100	0.02	CDSA1
Padlock for DS-SA1		0.22	CDSA2
Adapter and padlock		0.24	CDSA3

Labelling accessories

Description	For use on:	Package quantity	Catalog number
1 Pkg. of label carriers	CDNF30, CDNF45 CDNF60, CDNF63 CDNF100	100 pieces	CDTL-ST
1 Pkg of blank description labels		315 pieces	CDT-E

Legend plates for selector handles

Description	For use on:	Catalog number	
Blank plate	CDH15, 25, 75, 85, 115, 125 155, 165, 175, 185, 195, 205	CDPB1 CDPY1 CDPB2 CDPY2	
			CDH35, 45, 55, 65, 95, 105, 135, 145
			CDH15, 25, 75, 85, 115, 125 155, 165, 175, 185, 195, 205
Plate marked with: MAIN SWITCH	CDH35, 45, 55, 65, 95, 105, 135, 145	CDPB1EN1 CDPY1EN1 CDPB2EN1 CDPY2EN1	
			CDH15, 25, 75, 85, 115, 125 155, 165, 175, 185, 195, 205
			CDH15, 25, 75, 85, 115, 125 155, 165, 175, 185, 195, 205

Locking accessories

Description	For use on:	Weight (lbs.)	Catalog number
Cam attachment for Kirk Key, Castell, Lowe & Fletcher and Ronis interlock. For adapting to the interlock system. The interlock is not included.	5, 6 & 8mm shafts	0.29	CDETL-ZW16

DIN rail

Description	For use on:	Weight (lbs.)	Length inches/mm	Catalog number
35mm DIN Rail	CDNF16 – CDNF100	.38	39.4/1000	NDNA100
35mm Aluminum DIN Rail	CDNF16 – CDNF100	.75	78.8/1000	NDNA200

Shaft support

Description	For use on:	Weight (lbs.)	Catalog number
Shaft support	CDNF16 – CDNF100	0.30	CDTL-ZX58

for 16A – 100A Non-Fusible Disconnect Switches Base & DIN Rail Mounted

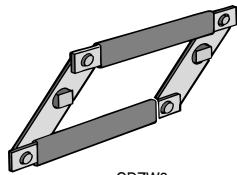

CDZW8

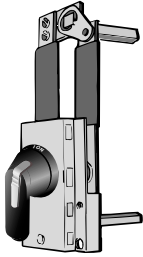

CDZW6

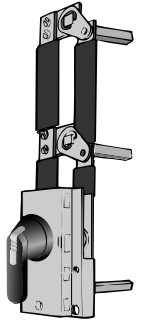

CDZW17

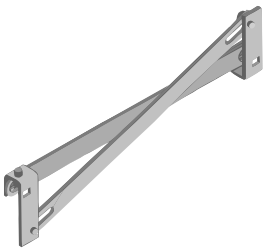

CDZW24

Conversion mechanisms

- For use with Base and DIN rail mounted switches only
- Switches are not included

Description	For use on:	Weight (lbs.)	Catalog number
6 or 8 pole	CDNF16 – CDNF100	0.33	CDZW8
Transfer		1.87	CDZW6
Bypass		1.54	CDZW17

6 or 8 pole — CDZW8

6 (8) pole mechanism allows two switches controlled by one handle to open or close simultaneously.

Equipment required for a complete installation:

- One conversion mechanism
- Two disconnect switches
- One handle^①
- One 5mm shaft

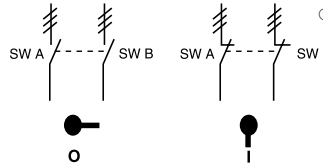

	POS. O	POS. I
SW. A	O	X
SW. B	O	X

X = Closed
O = Open

Transfer — CDZW6/CDZW6X

Transfer mechanism manually transfers between two power sources using two switches and a center OFF position.

A 3-position handle is included:

(UL Type 1, 3R & 12) or
(UL Type 1, 3R, 4, 4X, 12)

Shafts included. Equipment required for a complete installation:

- One conversion mechanism
- Two disconnect switches

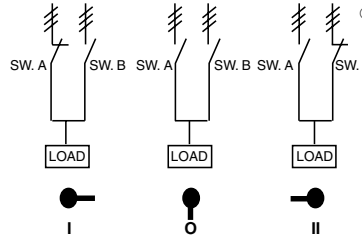

	POS. I	POS. O	POS. II
SW. A	X	O	O
SW. B	O	O	X

X = Closed
O = Open

Bypass — CDZW17

Bypass mechanism operates three switches: Two switches in series and one changeover switch to allow power bypass.

A 3-position handle is included:

(UL Type 1, 3R & 12) or
(UL Type 1, 3R, 4, 4X, 12) Shafts

included. Equipment required for a complete installation:

- One conversion mechanism
- Three disconnect switches

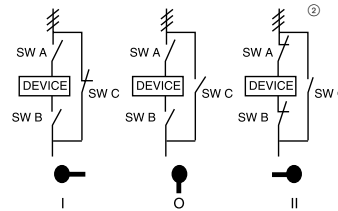

	POS. I	POS. O	POS. II
SW. A	O	O	X
SW. B	O	O	X
SW. C	X	O	O

X = Closed
O = Open

Mechanical interlock — CDZW24

Mechanical interlock mechanism prevents both switches from being in the ON position at the same time.

Equipment required for a complete installation:

- One conversion mechanism
- Two disconnect switches
- Two handles
- Two shafts

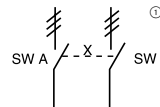

	SW. A POS. I	SW. B POS. I
SW. A	X	O
SW. B	O	X

X = Closed
O = Open

① CDNF16 – CDNF32 can use a selector or pistol handle. All other sizes must use a pistol handle.

② ≡ = Three poles

Fusible

Non-Fused

Enclosed Fused

Enclosed Non-Fused

Non-Fusible Disconnect Switches

Door Mounted

For a complete assembly, please order one of each:

- 1 switch
- 1 handle



CDNF45D



CDH9S

Fusible

Non-Fused

Enclosed Fused

Enclosed Non-Fused



CDNF16
CDNF25
CDNF32



CDH8S
CDH12S



CDH17S
CDH19S



CDH9S
CDH13S



CDH10S
CDH14S

16 – 100 Amp switches, 600V, 3 pole^{①②③}

UL general purpose amp rating	IEC AC21 amp rating	Maximum horsepower rating						Terminal lugs		Catalog number
		Single phase		Three phase				Wire size	Wire type	
		120V	240V	200V	240V	480V	600V			
16	16	1/2	1.5	3	5	10	10	#18 – 8	Cu	CDNF16D
25	25	3/4	2	7.5	7.5	15	20	#18 – 8	Cu	CDNF25D
40	40	1	3	10	10	20	25	#18 – 8	Cu	CDNF32D
60 ^④	63	2	5	15	15	30	20	#14 – 4	Cu	CDNF45D
80 ^④	80	2	5	20	20	40	40	#14 – 1	Cu	CDNF63D
30 ^④	40	2	5	10	10	20	30	#14 – 4	Cu	CDNF30D
60 ^④	63	3	7.5	20	20	40	40	#14 – 4	Cu	CDNF60D
100 ^④	115	5	15	25	25	50	40	#8 – 1/0	Cu	CDNF100D

Selector handles

NEMA/UL type	IEC type	Color	Defeatable	Padlockable	Weight (lbs)	Catalog number
--------------	----------	-------	------------	-------------	--------------	----------------

All marked both O/I & Off/On

Snap-on mounting — for use on CDNF16, 25, 32D

1	IP54	Black	—	—	0.10	CDH7S
1	IP54	Red/Yel	—	—	0.10	CDH8S
1	IP54	Black	—	Yes	0.13	CDH19S
1	IP54	Red/Yel	—	Yes	0.13	CDH20S
1,3R,12	IP65	Black	—	Yes	0.17	CDH9S
1,3R,12	IP65	Red/Yel	—	Yes	0.17	CDH10S

Screw mounting — for use on CDNF16, 25, 32, 45 & 63D

1	IP54	Black	—	—	0.11	CDH11S
1	IP54	Red/Yel	—	—	0.11	CDH12S
1	IP54	Black	—	Yes	0.14	CDH17S
1	IP54	Red/Yel	—	Yes	0.14	CDH18S
1,3R,12	IP65	Black	—	Yes	0.18	CDH13S
1,3R,12	IP65	Red/Yel	—	Yes	0.18	CDH14S

Door mounted switches do not provide door interlock

Pistol grip handle adapter

Description	For use on:	Weight (lbs)	Catalog number
Adapter piece for pistol grip handle	CDNF30, CDNF60, CDNF100	0.18	CDHZX6

- ① A snap on fourth pole may be added
- ② Door mounted switches do not require shafts.
- ③ CDNF16, 25, 32, 45 & 63 door mounted switches will not accept pistol handles.
- ④ CDNF45 & 63 door mounted switches can only use screw mounted handles.

for 16A – 100A Non-Fusible Disconnect Switches

Door Mounted

Door mounted switches

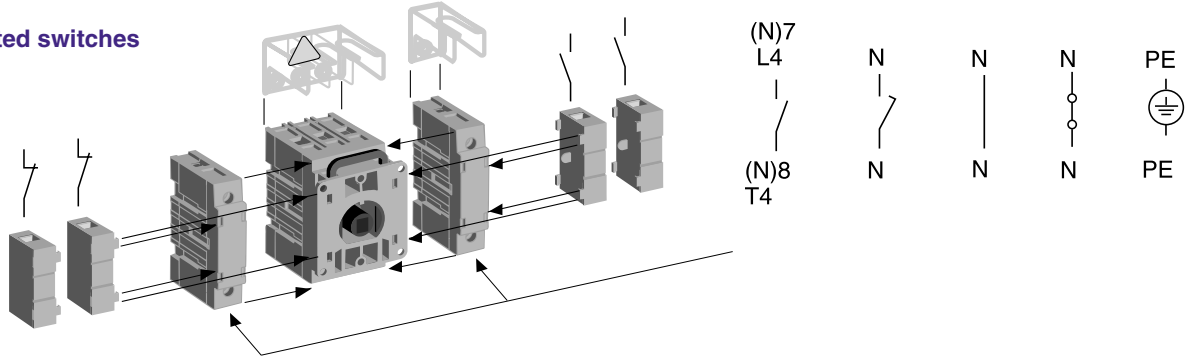

Fusible

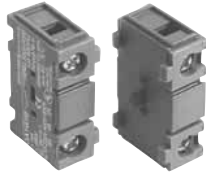

CDAUX_

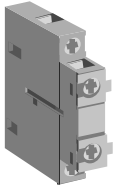

CDAUX11

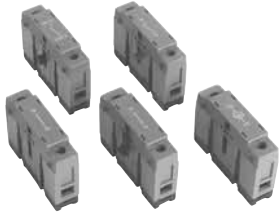

CD_32D



CD_63D

Auxiliary contacts^① — snap-on mounting

Description	For use on:	Weight (lbs)	AC thermal amp rating	AC rated voltage	Catalog number
1 N.O. mounts on righthand side of switch	CDNF16D - CDNF100D	0.07	10	600	CDAUX10
1 N.C. mounts on lefthand side of switch		0.07	10	600	CDAUX01
1 N.O. + 1 N.C. mounts on left or right hand side of switch		0.07	10	600	CDAUX11

Max. two contacts on each side of switch

Non-Fused

Power poles

- Only one power pole per switch
- Mounts on left or right side of switch

Description	For use on:	Weight (lbs)	AC thermal amp rating	AC rated voltage	Catalog number
Fourth pole ^②	CDNF16D, CDNF25D, CDNF32D	0.07	40	600	CDS32D
	CDNF45D, CDNF63D	0.13	80	600	CDS63D
	CDNF30D, CDNF60D, CNDNF100D	0.20	100		CDS100D
Late-break/early-make ^②	CDNF16D, CDNF25D, CDNF32D	0.07	40	600	CDL32D
	CDNF45D, CDNF63D	0.13	80	600	CDL63D
	CDNF30D, CDNF60D, CNDNF100D	0.20	100		CDL100D

Enclosed Fused

Terminal poles

- Switch accepts one terminal pole per side
- Mounts on left or right side of switch

Description	For use on:	Weight (lbs)	AC thermal amp rating	AC rated voltage	Catalog number
Solid neutral ^②	CDNF16D, CDNF25D, CDNF32D	0.07	40	600	CDN32D
	CDNF45D, CDNF63D	0.13	80	600	CDN63D
	CDNF30D, CDNF60D, CNDNF100D	0.20	100		CDN100D
Ground terminal ^②	CDNF16D, CDNF25D, CDNF32D	0.07	40	600	CDE32D
	CDNF45D, CDNF63D	0.13	80	600	CDE63D
	CDNF30D, CDNF60D, CNDNF100D	0.20	100		CDE100D

Enclosed Non-Fused

① UL File # E83510

② Switch accepts one power pole or one terminal pole per side. Only one power pole per switch.

for 16A – 100A Non-Fusible Disconnect Switches

Door Mounted

Fusible

Non-Fused

Enclosed Fused

Enclosed Non-Fused

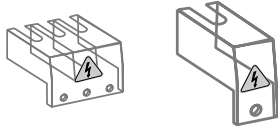

CDTS_T3

CDTS_T1

Terminal shrouds* — snap-on mounting for line or load side

Description	For use on:	Weight (lbs)	Catalog number
3 pole includes one shroud for line or load side	CDNF16D, 25D, 32D	0.02	CDTS32T3
	CDNF45D & 63D	0.02	CDTS63T3
	CDNF30D, 60D, 100D	0.02	CDTS100T3
4 pole includes one shroud for line or load side	CD_32D	0.02	CDTS32T1
	CD_63D	0.02	CDTS63T1
	CD_100D	0.02	CDTS100T1

* All disconnects are IP20 touch safe as standard. Terminal shrouds provide an additional level of protection.

Legend plates for selector handles

Description	For use on:	Catalog number
Blank plate	CDH15, 25, 75, 85, 115, 125 155, 165, 175, 185, 195, 205	CDPB1
		CDPY1
	CDH35, 45, 55, 65, 95 105, 135, 145	CDPB2
		CDPY2
Plate marked with: MAIN SWITCH	CDH15, 25, 75, 85, 115, 125 155, 165, 175, 185, 195, 205	CDPB1EN1
		CDPY1EN1
	CDH35, 45, 55, 65, 95 105, 135, 145	CDPB2EN1
		CDPY2EN1

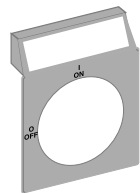

CDP_

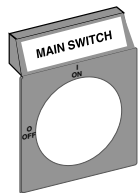

CPP_EN1

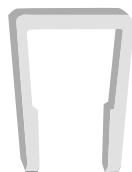

CDBY68140

Locking clip (replacement part)

Description	For use on:	Catalog number
Door mounted switch handle locking clip	CDNF16D CDNF25D CDNF32D	CDBY68140

Non-Fusible Disconnect Switches

For a complete assembly, please select one of each:

- 1 switch
- 1 handle
- 1 shaft

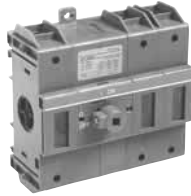

CDNF160



BDS210



BDH60

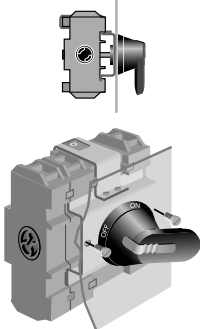

CDNF160D



BDH60



BDH61



BDS_

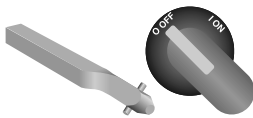

BDST_

125 Amp Base & DIN rail mounted switches^①, 600V

UL general purpose amp rating	IEC AC21 amp rating	Maximum horsepower rating					Terminal lugs		Catalog number
		Three phase					Wire size	Wire type	
		200V	208V	240V	480V	600V			
2 pole 125	160	—	—	—	—	—	#8 – 1/0	Cu	CDNF160-2
3 pole 125	160	30	30	30	60	75	#8 – 1/0	Cu	CDNF160

125 Amp Door mounted switch^①, 600V, 3 pole

UL general purpose amp rating	IEC AC21 amp rating	Maximum horsepower rating					Terminal lugs		Catalog number
		Three phase					Wire size	Wire type	
		200V	208V	240V	480V	600V			
125	160	30	30	30	60	75	#8 – 1/0	Cu	CDNF160D

Pistol handles — for use with □ .24 x .24" (□ 6 x 6 mm)

NEMA type	IEC type	Color	Length in/mm	Marking	Defeat-able	Padlock-able	Weight (lbs)	Catalog number
1, 3R, 12	IP65	Black	2.6/65	O/I & Off/On	Yes	Yes	0.29	BDH58
1, 3R, 12	IP65	Red/Yel	2.6/65	O/I & Off/On	Yes	Yes	0.29	BDH59
1, 3R, 12	IP65	Black	3.1/80	O/I & Off/On	Yes	Yes	0.30	BDH60
1, 3R, 12	IP65	Red/Yel	3.1/80	O/I & Off/On	Yes	Yes	0.30	BDH61
1, 3R, 4, 4X, 12	IP66	Black	3.1/80	O/I & Off/On	Yes	Yes	0.30	CDHXB86
1, 3R, 4, 4X, 12	IP66	Red/Yel	3.1/80	O/I & Off/On	Yes	Yes	0.30	CDHXY86

Shafts — for use with pistol handles □ .24 x .24" (□ 6 x 6 mm)

Shaft length inches/mm		Mounting depth ^② in inches	Weight (lbs)	Catalog number
5.2/130		4.3 – 6.0	0.08	BDS130
5.9/150		5.0 – 6.7	0.09	BDS150
8.3/210		7.4 – 9.1	0.13	BDS210
11.4/290		10.5 – 12.2	0.18	BDS290
14.2/360		13.3 – 15.0	0.23	BDS360
16.9/430		16.0 – 17.8	0.27	BDS430

Twisted shafts — Rotates handle 45° □ .24 x .24" (□ 6 x 6 mm)

Shaft length inches/mm		Mounting depth ^② in inches	Weight (lbs)	Catalog number
5.2/130		4.3 – 6.0	0.08	BDST4
8.3/210		7.4 – 9.1	0.13	BDST25
11.4/290		10.5 – 12.2	0.18	BDST29
14.2/360		13.3 – 15.0	0.23	BDST30

① A snap on fourth pole may be added

② Mounting depth is the distance from the outside of the door to the disconnect switch mounting plate. Shaft can be cut to desired length.

Fusible

Non-Fused

Enclosed Fused

Enclosed Non-Fused

for 125A Non-Fusible Disconnect Switches

Fusible

Non-Fused

Enclosed Fused

Enclosed Non-Fused

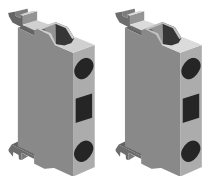

CDAUXCA10 CDAUXCA01

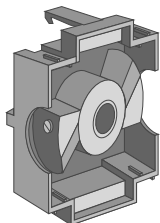

CDAUXB160



CDAUX16011 CDMB160

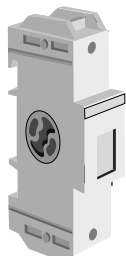

CD_160P

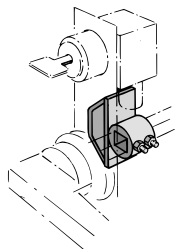

CDETL-ZW16

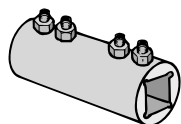

BDZX167
BDZX95

Auxiliary contacts, top mounted

- Accepts four contacts maximum, mounting base always required

Description	For use on:	Weight (lbs)	AC thermal amp rating	AC rated voltage	Catalog number
1 N.O. 1 N.C.	CDNF160	0.07	10 10	600 600	CDAUXCA10 CDAUXCA01
1 N.O. gold plated ^① 1 N.C. gold plated ^①	CDNF160	0.07	10 10	600 600	CDEA-10AU CDEA-01AU
Mounting base – required for CDAUX_	CDAUX_	0.06	—	—	CDAUXB160

Auxiliary contacts, side mounted

- Accepts four contacts maximum

Description	For use on:	Weight (lbs)	AC thermal amp rating	AC rated voltage	Catalog number
1 N.O. & 1 N.C.	CDNF160	0.07	10	600	CDAUX16011
Mounting base, required for CDAUX16011	CDNF160	0.06	—	—	CDMB160

Max. two contacts on each side of switch. One mounting base required for each side of switch

Numbering stickers^②

Description	For use on:	Package qty.	Catalog number
1 Pkg. of blank labels for OBEA-10, 1 N.O.	CDNF160	10	CDEA-ZX10
1 Pkg. of blank labels for OBEA-01, 1 N.C.	CDNF160	10	CDEA-ZX01

Power pole — for use with base or door mounted switch

- Only one power pole per switch
- Mounts on left or right side of switch

Description	For use on:	Weight (lbs)	AC thermal amp rating	AC rated voltage	Catalog number
Fourth pole	CDNF160	0.66	125	600	CDS160P

Terminal poles — for use with base or door mounted switch

- Switch accepts one terminal pole per side
- Mounts on left or right side of switch

Description	For use on:	Weight (lbs)	AC thermal amp rating	AC rated voltage	Catalog number
Detachable neutral mounts on side of switch or DIN rail	CDNF160	0.66	125	600	CDN160P
Ground terminal	CDNF160	0.66	125	600	CDE160P

Locking accessories

Description	For use on:	Weight (lbs)	Catalog number
Cam attachment for Kirk Key, Castell, Lowe & Fletcher and Ronis interlock. For adapting to the interlock system. The interlock is not included.	5, 6 & 8mm shafts	0.29	CDETL-ZW16

Handle support bracket

Description	For use on:	Weight (lbs)	Catalog number
Allows pistol handle to be directly mounted to switch behind the door	CDNF160	0.33	CDZX5

Shaft extension couplers

Description	For use on:	Weight (lbs)	Catalog number
Joins two shafts together for applications where extended length is required	for 6mm shafts for 12mm shafts	0.26 0.26	BDZX167 BDZX95

① Type _AU for low energy applications. The contacts are gold-plated. AC & DC ratings — Maximum: A600 & P600. Minimum: 12V, 1mA; 5V, 2mA

② Required if several contact blocks are used in the same installation.

for 125A Non-Fusible Disconnect Switches

Fusible

Non-Fused

Enclosed Fused

Enclosed Non-Fused

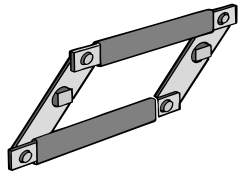

BDZW2

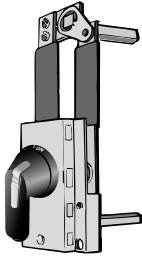

BDZW1

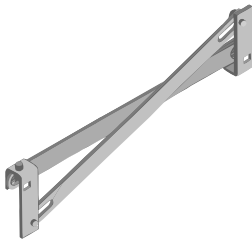

CDZW10

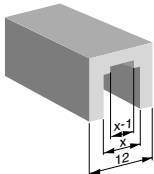

CDZK19
(X = 6mm)



CDBY68005



CDMC2

Conversion mechanisms

- For use with Base and Din rail mounted switches only
- Switches are not included

Description	For use on:	Weight (lbs.)	Catalog number
6 or 8 pole	CDNF160	1.52	BDZW2
Transfer (1, 3R, 12)		2.20	BDZW1
Transfer (4X)		2.20	BDZW1X
Mechanical interlock		0.55	CDZW10

6 or 8 pole — BDZW2

6 (8) pole mechanism allows two switches controlled by one handle, to open or close simultaneously. Shafts included.

Equipment required for a complete installation:

- One conversion mechanism
- Two disconnect switches
- One handle

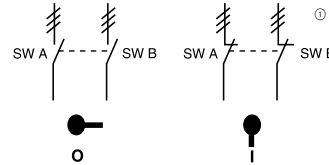

	POS. O	POS. I
SW. A	O	X
SW. B	O	X

X = Closed
O = Open

Transfer — BDZW1

Transfer mechanism manually transfers between two power sources using two switches and a center OFF position. A 3 position handle is included. (UL Type 1, 3R & 12) or (UL Type 1, 3R, 4, 4X, 12) Shafts included. Equipment required for a complete installation:

- One conversion mechanism
- Two disconnect switches

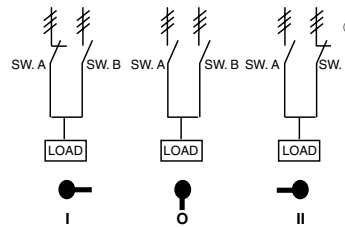

	POS. I	POS. O	POS. II
SW. A	X	O	O
SW. B	O	O	X

X = Closed
O = Open

Mechanical interlock — CDZW10

Mechanical interlock mechanism prevents both switches from being in the ON position at the same time.

Equipment required for a complete installation:

- One conversion mechanism
- Two disconnect switches
- Two handles
- Two shafts



	SW. A POS. I	SW. B POS. I
SW. A	X	O
SW. B	O	X

X = Closed
O = Open

Shaft adapter

Description	For use on:	Weight (lbs)	Catalog number
Adapts one end of a 5 or 6mm shaft to 12mm Use with shaft extension coupler	5 & 6mm shafts	0.20	CDZK19

Power pole interlock (replacement part)

Description	For use on:	Weight (lbs)	Catalog number
Interlocks a power pole with an adjacent power pole	CDNF160	0.05	CDBY68005

Replacement collar (optional replacement for knob)

Description	For use on:	Weight (lbs)	Catalog number
Red knob (like original) for locking shaft in place ** re-use original set screw **	CDNF160	0.05	CXBY68100
Replaces original red knob for locking shaft in place ** re-use original set screw **	CDNF160	0.05	CDMC2

① ≡ = Three poles

for Non-Fusible Disconnect Switches

For a complete assembly, please select one of each:

- 1 switch
- 1 handle
- 1 shaft
- 1 terminal lug kit

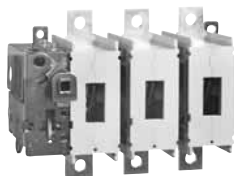

BDNF200A



BDS240



BDH110



BDTL25

Fusible

Non-Fused

Enclosed Fused

Enclosed Non-Fused

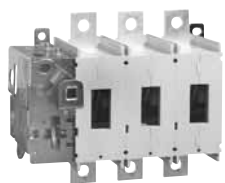

BDNF175A



BDH108



BDH109



BDS__

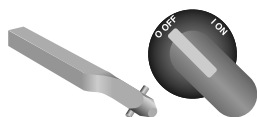

CDS340T

175 – 200 Amp switches, 600V

UL general purpose amp rating	IEC AC21 Amp rating	Maximum horsepower rating					Catalog number
		Three phase					
		200V	208V	240V	480V	600V	
2 pole	175	—	—	—	—	—	BDNF175A2 BDNF200A2
	200	—	—	—	—	—	
3 pole	175	30	30	40	75	100	BDNF175A BDNF200A
	200	60	60	75	150	200	
4 pole	175	30	30	40	75	100	BDNF175A4 BDNF200A4
	200	60	60	75	150	200	

Pistol handles — for use with shafts □ .31 x .31" (□ 8 x 8mm)

NEMA type	IEC type	Color	Length mm	Marking	Defeatable	Padlockable	Weight (lbs)	Catalog number
1,3R,12	IP65	Black	2.6/65	O/I & Off/On	Yes	Yes	0.29	BDH108
1,3R,12	IP65	Red/Yellow	2.6/65	O/I & Off/On	Yes	Yes	0.29	BDH109
1,3R,12	IP65	Black	3.1/80	O/I & Off/On	Yes	Yes	0.30	BDH110
1,3R,12	IP65	Red/Yellow	3.1/80	O/I & Off/On	Yes	Yes	0.30	BDH111
1,3R,4,4X,12	IP66	Black	3.1/80	O/I & Off/On	Yes	Yes	0.30	CDHXB88
1,3R,4,4X,12	IP66	Red/Yellow	3.1/80	O/I & Off/On	Yes	Yes	0.30	CDHXY88

Shafts — for use with pistol handles □ .31 x .31" (□ 8 x 8mm)

Shaft length inches/mm	Mounting depth ^① in inches BDNF175A – BDNF200A	Weight (lbs)	Catalog number
5.5/140	4.7 – 8.7	0.15	BDS140
9.5/240	8.7 – 12.6	0.26	BDS240
13.4/340	12.6 – 16.6	0.36	BDS340
19.5/500	18.9 – 22.9	0.54	BDS500

Twisted shafts — Rotates handle 45° □ .31 x .31" (□ 8 x 8mm)

Shaft length inches/mm	Mounting depth ^① in inches BDNF175A – BDNF200A	Weight (lbs)	Catalog number
13.4/340	12.6 – 16.6	0.36	CDS340T

① Mounting depth is the distance from the outside of the door to the disconnect switch mounting plate. Shaft can be cut to desired length.
 ② Availability to be announced.

for 175A – 200A Non-Fusible Disconnect Switches



BDTL25

BDTL175

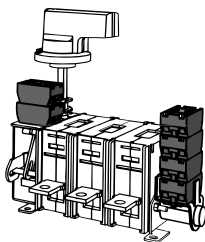

BDAUX12, 13

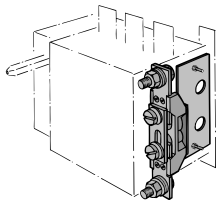

BDZX129

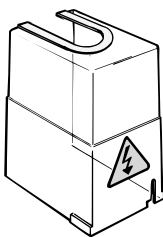

BDTS2

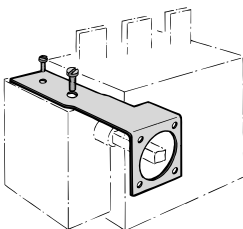

BDZX131

Terminal lug kits

For use on:	Wire size	Kit weight (lbs.)	Wire type	Terminal lugs per kit	Catalog number
BDNF175A & BDNF200A	#6 – 300 kcmil	0.93	Cu/Al	6	BDTL25
	#6 – 300 kcmil	0.47	Cu/Al	3	BDTL253P
	*(6) #14 – 6	0.55	Cu/Al	3	BDTL175

*A load side distribution lug eliminates the need to purchase, install and wire a separate distribution block.

Auxiliary contacts[Ⓟ]

Description*	For use on:	Weight (lbs)	AC thermal amp rating	AC rated voltage	Catalog number
1 N.O. + 1 N.C.	BDNF175A	0.09	10	600	BDAUX12
2 N.O. + 2 N.C.		0.18	10	600	BDAUX13
4 N.O. + 4 N.C.		0.35	10	600	BDAUX16
2 N.O.	BDNF200A	0.09	10	600	BDAUX14
4 N.O.		0.18	10	600	BDAUX15
8 N.O.		0.35	10	600	BDAUX17

*Contact configuration when mounted on switch, not shelf state.

Terminal poles

Description	For use on:	Weight (lbs)	AC thermal amp rating	AC rated voltage	Catalog number
Detachable neutral mounts on side of switch or DIN rail	BDNF175A BDNF200A	0.84	200	600	BDZX129

Terminal shrouds

Description	For use on:	Weight (lbs)			Catalog number
Includes one set of 3 shrouds for use on line or load side	BDNF175A BDNF200A	0.40			BDTS2

Handle support bracket

Description	For use on:	Weight (lbs)			Catalog number
Allows handle to be directly mounted to switch behind the door	BDNF175A BDNF200A	0.33			BDZX131

① UL File E57057 _____

Fusible

Non-Fused

Enclosed Fused

Enclosed Non-Fused

for 175A – 200A Non-Fusible Disconnect Switches

Fusible

Non-Fused

Enclosed Fused

Enclosed Non-Fused

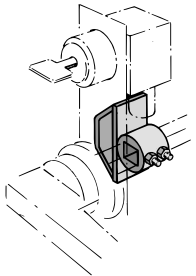

CDETL-ZW16

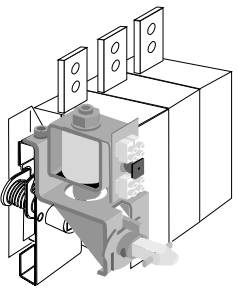

CDETL-ZT 80A

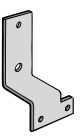

CDETL-ZT140

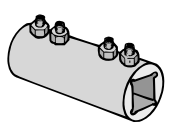

BDZW95

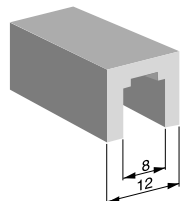

CDZT123

Locking accessories

Description	For use on:	Weight (lbs.)	Catalog number
Cam attachment for Kirk Key, Castell, Lowe & Fletcher and Ronis interlock. For adapting to the interlock system The interlock is not included.	5, 6 & 8mm shafts	0.29	CDETL-ZW16
Electrical interlock Ⓢ Closed circuit principle for interlocking the switch movement. When the coil circuit is dead, A-types cannot be operated to ON-position and L-types cannot be operated to ON- or OFF-position. Coil voltages 110VAC, 220VAC, 24VDC, 48VDC, 60 VDC, 110VDC, 220VDC, P = 15W U = 0.7 – 1.1 Un (U = coil voltage, Un = nominal voltage)	BDNF175A – BDNF200A	2.42	CDETL-ZT80A/★ CDETL-ZT80L/★
Mounting bracket	BDNF175A – BDNF200A	0.35	CDETL-ZT140

★ - Coil voltage

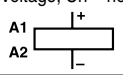

Shaft extension coupler

Description	For use on:	Weight (lbs.)	Catalog number
Joins two shafts together for applications where extended length is required	12mm shafts	0.26	BDZW95

Shaft adapter

Description	For use on:	Weight (lbs.)	Catalog number
Adapts one end of an 8mm shaft to a 12mm shaft. Use with shaft extension coupler.	8mm shafts	0.20	CDZT123

Ⓢ CDETL-ZT140 mounting bracket required.

for 175A – 200A Non-Fusible Disconnect Switches

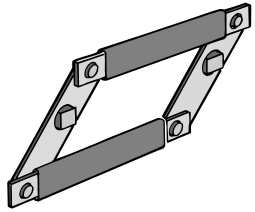

BDZW18

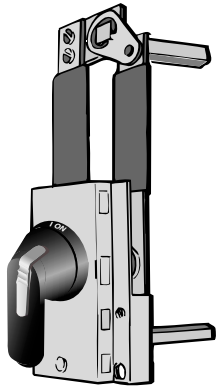

BDZW20

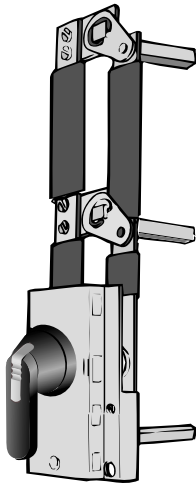

BDZW21

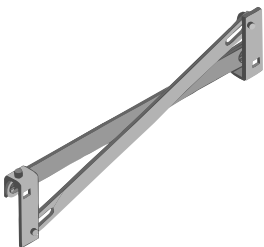

BDZW19

Conversion mechanisms

- Switches are not included

Description	For use on:	Weight (lbs)	Catalog number
6 or 8 pole Transfer	BDNF175A BDNF200A	1.61	BDZW18
Transfer		6.17	BDZW20
Bypass		6.17	BDZW20X
Bypass		7.27	BDZW21
Mechanical interlock		7.27	BDZW21X
		4.41	BDZW19

6 or 8 pole — BDZW18

6 (8) pole mechanism allows two switches controlled by one handle to open or close simultaneously. Shafts included.

Equipment required for a complete installation:

- One conversion mechanism
- Two disconnect switches
- One handle

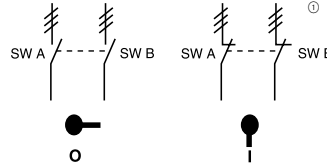

	POS. O	POS. I
SW. A	O	X
SW. B	O	X

X = Closed
O = Open

Transfer — BDZW20

Transfer mechanism manually transfers between two power sources using two switches and a center OFF position.

A 3-position handle is included:

(Type 1, 3R, 12) or

(Type 1, 3R, 4, 4X, 12)

Shafts included. Equipment required for a complete installation:

- One conversion mechanism
- Two disconnect switches

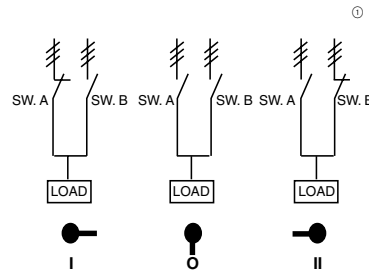

	POS. I	POS. O	POS. II
SW. A	X	O	O
SW. B	O	O	X

X = Closed
O = Open

Bypass — BDZW21

Bypass mechanism operates three switches: Two switches in series and one changeover switch to allow power bypass.

A 3-position handle is included:

(Type 1, 3R & 12) or

(Type 1, 3R, 4, 4X, 12)

Shafts included.

Equipment required for a complete installation:

- One conversion mechanism
- Three disconnect switches

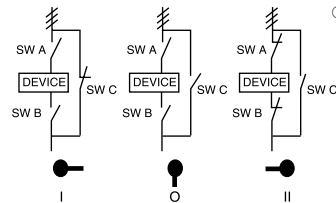

	POS. I	POS. O	POS. II
SW. A	O	O	X
SW. B	O	O	X
SW. C	X	O	O

X = Closed
O = Open

Mechanical interlock — BDZW19

Mechanical interlock mechanism prevents both switches from being in the ON position at the same time.

Equipment required for a complete installation:

- One conversion mechanism
- Two disconnect switches
- Two handles
- Two shafts

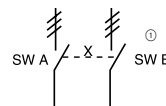

	SW. A POS. I	SW. B POS. I
SW. A	X	O
SW. B	O	X

X = Closed
O = Open

① ≡ = Three poles

Non-Fusible Disconnect Switches

For a complete assembly, please select one of each:

- 1 switch
- 1 handle
- 1 shaft
- 1 terminal lug kit



BDNF400



BDS280



BDH116



BDTL26

Fusible

Non-Fused

Enclosed Fused

Enclosed Non-Fused



BDNF600A



BDNF800A



BDH112-117



BDS280

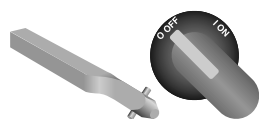

BDS_45

400 – 800 Amp switches, 600V

UL general purpose amp rating	IEC AC21 amp rating	Maximum horsepower rating					Catalog number
		200V	208V	240V	480V	600V	
2 pole							
400	630	—	—	—	—	—	BDNF4002 BDNF600A2 BDNF800A2
600	800	—	—	—	—	—	
800	1250	—	—	—	—	—	
3 pole							
400	630	100	100	125	250	350	BDNF400 BDNF600A BDNF800A
600	800	150	150	200	400	500	
800	1250	200	200	250	500	600	
4 pole							
400	630	100	100	125	250	350	BDNF4004 BDNF600A4 BDNF800A4
600	800	150	150	200	400	500	
—	1250	200	200	250	500	600	

Pistol handles — for use with shafts □ .47 x .47" (□ 12 x 12 mm)

NEMA type	IEC type	Color	Length in/mm	Marking	Defeatable	Padlockable	Weight (lbs)	Catalog number
1,3R,12	IP65	Blk	4.9/125	O/I & Off/On	Yes	Yes	0.39	BDH112
1,3R,12	IP65	R/Y	4.9/125	O/I & Off/On	Yes	Yes	0.39	BDH113
1,3R,12	IP65	Blk	5.7/145	O/I & Off/On	Yes	Yes	0.39	BDH114
1,3R,12	IP65	R/Y	5.7/145	O/I & Off/On	Yes	Yes	0.39	BDH115
1,3R,12	IP65	Blk	6.9/175	O/I & Off/On	Yes	Yes	0.41	BDH116
1,3R,12	IP65	R/Y	6.9/175	O/I & Off/On	Yes	Yes	0.41	BDH117
1,3R,4,4X,12	IP66	Blk	5.7/145	O/I & Off/On	Yes	Yes	0.39	CDHXB12
1,3R,4,4X,12	IP66	R/Y	5.7/145	O/I & Off/On	Yes	Yes	0.39	CDHXY12
1,3R,4,4X,12	IP66	Blk	6.9/175	O/I & Off/On	Yes	Yes	0.41	CDHXB22
1,3R,4,4X,12	IP66	R/Y	6.9/175	O/I & Off/On	Yes	Yes	0.41	CDHXY22
1,3R,4,4X,12	IP65	Metal	8.7/220	Off/On	—	Yes	1.50	BDH8

Shafts — for use with pistol handles □ .47 x .47" (□ 12 x 12 mm)

Shaft length inches/mm	Mounting depth ^① in inches	Weight (lbs)	Catalog number
11.0/280	10.2 – 14.5	0.77	BDS280
12.8/325	12.0 – 16.3	0.90	BDS325
15.6/395	14.8 – 19.1	1.10	BDS395
18.3/465	17.5 – 21.9	1.32	BDS465
21.1/535	20.3 – 24.6	1.54	BDS535

Twisted shafts — Rotates handle 45° □ .47 x .47" (□ 12 x 12 mm)

Shaft length inches/mm	Mounting depth ^① in inches	Weight (lbs)	Catalog number
11.0/280	10.2 – 14.5	0.77	BDS28045
12.8/325	12.0 – 16.3	0.90	BDS32545
18.3/465	17.5 – 21.9	1.32	BDS46545

① Mounting depth is the distance from the outside of the door to the disconnect switch mounting plate. Shaft can be cut to desired length.

for 400A – 800A Non-Fusible Disconnect Switches

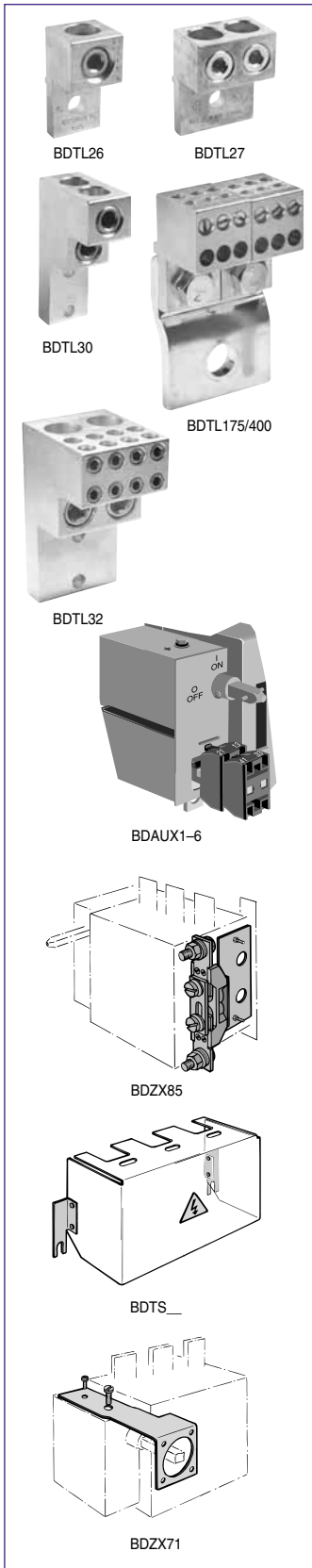

Terminal lug kits

For use on:	Wire size	Kit weight (lbs.)	Wire type	Terminal lugs per kit	Kit catalog number
BDNF400	#2 – 600 kcmil	3.50	Cu/Al	6	BDTL26
BDNF400	(2) #2 – 500 kcmil	4.62	Cu/Al	6	BDTL262
BDNF600A	(2) #2 – 600 kcmil	4.62	Cu/Al	6	BDTL27
BDNF800A	(2) #2 – 600 kcmil	6.90	Cu/Al	6	BDTL30
BDNF800A ^①	(8) 2/0 + (2)#2 600 kcmil	6.90	Cu/Al	3	BDTL32
BDNF400 – BDNF600A ^①	(12) #14 – 6	1.10	Cu/Al	6	BDTL175/400

Auxiliary contacts^②

Description	For use on:	Weight (lbs)	AC thermal amp rating	AC rated voltage	Catalog number
1 N.O. + 1 N.C.	BDNF400 – BDNF800A	0.20	10	600	BDAUX1
2 N.O. + 2 N.C.		0.26	10	600	BDAUX2
4 N.O. + 4 N.C.		0.40	10	600	BDAUX3
2 N.O.		0.18	10	600	BDAUX4
4 N.O.		0.25	10	600	BDAUX5
8 N.O.		0.40	10	600	BDAUX6

Terminal poles

Description	For use on:	Weight (lbs)	AC thermal amp rating	AC rated voltage	Catalog number
Detachable neutral mounts on side of switch or DIN rail	BDNF400 – BDNF600A	1.04	400	600	BDZX85

Terminal shrouds

Description	For use on:	Weight (lbs)	Catalog number
Includes one shroud for line or load side	BDNF400	0.62	BDTS4
	BDNF600A	0.66	BDTS6A
	BDNF800A	0.88	BDTS8A

Handle support bracket

Description	For use on:	Weight (lbs)	Catalog number
Allows handle to be directly mounted to switch behind the door	BDNF400 – BDNF600A	0.51	BDZX73
	BDNF800A	0.88	BDZX71

① A load side distribution lug eliminates the need to purchase, install and wire a separate distribution block.

② UL File E57057

Fusible

Non-Fused

Enclosed Fused

Enclosed Non-Fused

for 400A – 800A Non-Fusible Disconnect Switches

Fusible

Non-Fused

Enclosed Fused

Enclosed Non-Fused

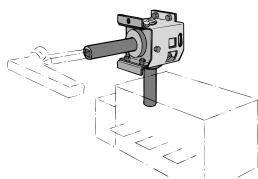

BDZX108

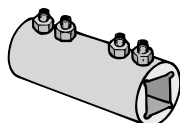

BDZW95

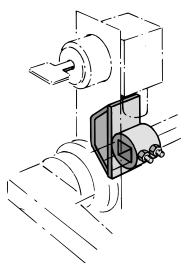

CDETL-ZW5

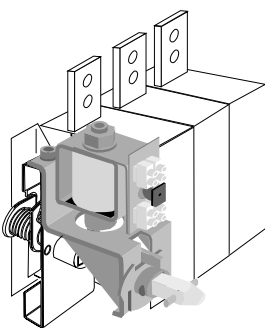

CDETL-ZT80_

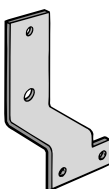

CDETL-ZT100

90° angle kit

Description	For use on:	Weight (lbs)	Catalog number
Converts switch mechanism from front operation to side operation	BDNF400 BDNF600A BDNF800A	4.63	BDZX108

Shaft extension coupler

Description	For use on:	Weight (lbs)	Catalog number
Joins two shafts together for applications where extended length is required	12mm shafts	0.26	BDZW95

Locking accessories

Description	For use on:	Weight (lbs)	Catalog number
Cam attachment for Kirk Key, Castell, Lowe & Fletcher and Ronis interlock. For adapting to the interlock system The interlock is not included.	12mm shafts	0.29	CDETL-ZW5
Electrical interlock ① Closed circuit principle for interlocking the switch movement. When the coil circuit is dead, A-types cannot be operated to ON-position and L-types cannot be operated to ON- or OFF-position. Coil voltages 110VAC, 220VAC, 24VDC, 48VDC, 60 VDC, 110VDC, 220VDC, P = 15W U = 0.7 – 1.1 Un (U = coil voltage, Un = nominal voltage)	BDNF400 BDNF600A BDNF800A	2.42	CDETL-ZT80A/★ CDETL-ZT80L/★
Mounting bracket	BDNF400 BDNF600A	0.40	CDETL-ZT100

★ – Coil voltage

① CDETL-ZT100 mounting bracket required for BDNF400 & BDNF600A

for 400A – 800A Non-Fusible Disconnect Switches

Fusible

Non-Fused

Enclosed Fused

Enclosed Non-Fused

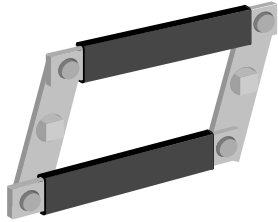

BDZW9

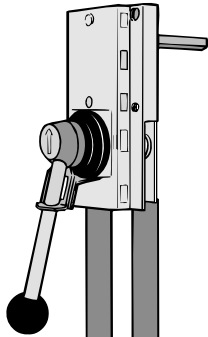

BDZW12

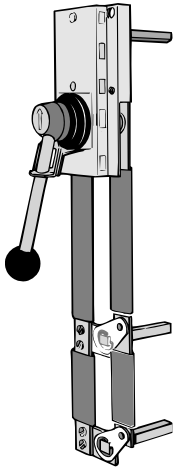

BDZW13

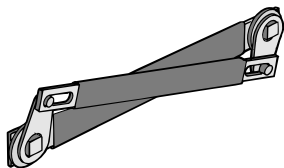

BDZW3, 14, 15

Conversion mechanisms

- Switches are not included

Description	For use on:	Weight (lbs)	Catalog number
6 or 8 pole Transfer Bypass	BDNF400 BDNF600A BDNF800A	2.42	BDZW9 BDZW12 BDZW13
		10.1	
		8.81	
Mechanical interlock	BDNF400 BDNF600A BDNF800A	1.26	BDZW3 BDZW14 BDZW15
		1.15	
		2.64	

6 or 8 pole — BDZW9

6 (8) pole mechanism allows two switches controlled by one handle to open or close simultaneously. One shaft included.

Equipment required for a complete installation:

- One conversion mechanism
- Two disconnect switches
- One handle
- One additional shaft (Only one shaft is included with mechanism).

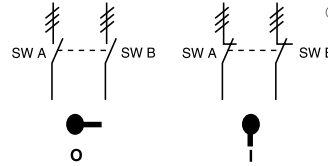

	POS.O	POS.I
SW. A	O	X
SW. B	O	X

X = Closed
O = Open

Transfer — BDZW12

Transfer mechanism manually transfers between two power sources using two switches and a center OFF position.

A 3 position handle is included. Shafts included.

Equipment required for a complete installation:

- One conversion mechanism
- Two disconnect switches

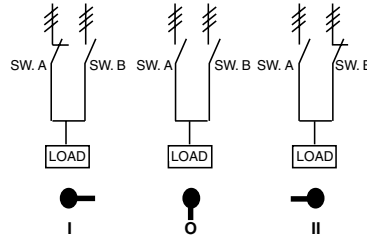

	POS. I	POS.O	POS.II
SW. A	X	O	O
SW. B	O	O	X

X = Closed
O = Open

Bypass — BDZW13

Bypass mechanism operates three switches: Two switches in series and one changeover switch to allow power bypass. A 3 position handle is included. (UL Type 1, 3R, 4, 4X, 12). Shafts included.

Equipment required for a complete installation:

- One conversion mechanism
- Three disconnect switches

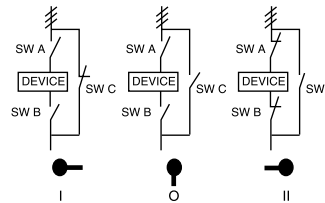

	POS. I	POS.O	POS.II
SW. A	O	O	X
SW. B	O	O	X
SW. C	X	O	O

X = Closed
O = Open

Mechanical interlock — BDZW3, BDZW14, BDZW15

Mechanical interlock mechanism prevents both switches from being in the ON position at the same time.

Equipment required for a complete installation:

- One conversion mechanism
- Two disconnect switches
- Two shafts
- Two handles

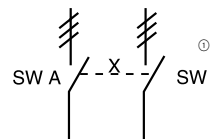

	SW. A POS. I	SW. B POS. I
SW. A	X	O
SW. B	O	X

X = Closed
O = Open

① = Three poles

Non-Fusible Disconnect Switches

For a complete assembly please select one of each:

- 1 switch
- 1 handle
- 1 shaft
- 1 terminal lug kit



BDNF1200



BDS280



BDH117



BDTL28

Fusible

Non-Fused

Enclosed Fused

Enclosed Non-Fused

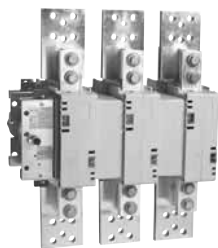

BDNF1600
BDNF2000
BDNF3150



BDH114



BDH115



BDH8



BDS325

1200 – 3150 Amp switches, 600V

UL general purpose amp rating	IEC AC21 amp rating	Maximum horsepower rating	Catalog number		
2 pole	1200	The US National Electric Code does not specify HP ratings for switches this large. Please select a switch based on 115% of application FLA. For example: a motor with an FLA of 800A would require a 1200A switch: 800A x 115% = 920A, the closest higher rated switch is 1200A.	BDNF12002 BDNF16002 BDNF20002 BDNF31502		
	1600				
	2000				
	—				
3 pole	1200		The US National Electric Code does not specify HP ratings for switches this large. Please select a switch based on 115% of application FLA. For example: a motor with an FLA of 800A would require a 1200A switch: 800A x 115% = 920A, the closest higher rated switch is 1200A.	BDNF1200 BDNF1600 BDNF2000 BDNF3150	
	1600				
	2000				
	—				
4 pole	—			The US National Electric Code does not specify HP ratings for switches this large. Please select a switch based on 115% of application FLA. For example: a motor with an FLA of 800A would require a 1200A switch: 800A x 115% = 920A, the closest higher rated switch is 1200A.	BDNF12004 BDNF16004 BDNF20004 BDNF31504
	—				
	—				
	—				

Pistol handles — for use with shaft □ .47 x .47" (□ 12 x 12mm)

NEMA type	IEC type	Color	Length mm	Marking	Defeatable	Padlockable	Weight (lbs)	Catalog number
For use with BDNF1200								
1,3R,12	IP65	Black	5.7/145	O/I & Off/On	Yes	Yes	0.39	BDH114
1,3R,12	IP65	Red/Yellow	5.7/145	O/I & Off/On	Yes	Yes	0.39	BDH115
1,3R,12	IP65	Black	6.9/175	O/I & Off/On	Yes	Yes	0.41	BDH116
1,3R,12	IP65	Red/Yellow	6.9/175	O/I & Off/On	Yes	Yes	0.41	BDH117
1,3R,4,4X,12	IP66	Black	5.7/145	O/I & Off/On	Yes	Yes	0.39	CDHXB12
1,3R,4,4X,12	IP66	Red/Yellow	5.7/145	O/I & Off/On	Yes	Yes	0.39	CDHXY12
1,3R,4,4X,12	IP66	Black	6.9/175	O/I & Off/On	Yes	Yes	0.41	CDHXB22
1,3R,4,4X,12	IP65	Red/Yellow	6.9/175	O/I & Off/On	Yes	Yes	0.41	CDHXY22
For use with BDNF1600 – 3150								
1,3R,4,4X,12	IP65	Metal	8.7/220	Off/On	—	Yes	1.50	BDH8

Shafts — for use with pistol handles □ .47 x .47" (□ 12 x 12 mm)

Shaft length inches/mm	Mounting depth [Ⓢ] in inches	Weight (lbs)	Catalog number
For use with BDNF1200			
11.0/280	11.6 – 15.3	0.77	BDS280
12.8/325	13.7 – 17.1	0.90	BDS325
15.6/397	16.2 – 19.9	1.10	BDS395
18.3/465	18.9 – 22.6	1.32	BDS465
21.1/536	21.7 – 25.4	1.54	BDS535
For use with BDNF1600 – 3150			
12.8/325	13.7 – 17.1	0.90	BDS325
15.6/397	16.2 – 19.9	1.10	BDS395
18.3/465	18.9 – 22.6	1.32	BDS465
21.1/536	21.7 – 25.4	1.54	BDS535

Ⓢ Mounting depth is the distance from the outside of the door to the disconnect switch mounting plate. Shaft can be cut to desired length.

for 1200A – 3150A Non-Fusible Disconnect Switches

Fusible

Non-Fused

Enclosed Fused

Enclosed Non-Fused

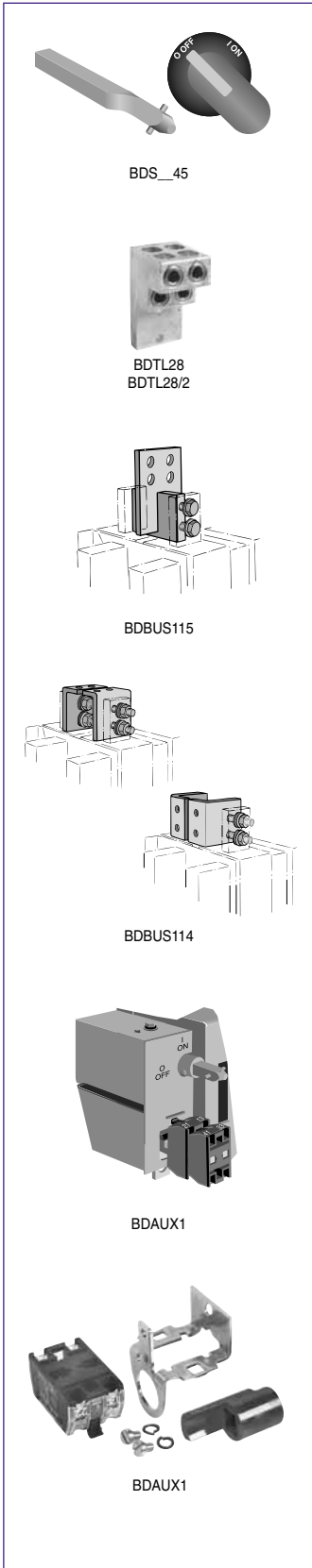

Twisted shafts – Rotates handle 45° □ .47 x .47" (□ 12 x 12 mm)

Shaft length inches/mm	Mounting depth ^① in inches	Weight (lbs)	Catalog number
For use with BDNF1200			
11.0/280	11.6 – 15.3	0.77	BDS28045
12.8/325	13.7 – 17.1	0.90	BDS32545
18.3/465	18.9 – 22.6	1.32	BDS46545
For use with BDNF1600 – 3150			
12.8/325	16.2 – 19.9	0.90	BDS32545
18.3/465	18.9 – 22.6	1.32	BDS46545

Terminal lug kits

For use on:	Wire size	Kit weight (lbs.)	Wire type	Terminal lugs per kit	Kit catalog number
BDNF1200 & BDNF1600	(4) #2 – 600kcmil	10.44	Cu/Al	6	BDTL28
BDNF1200 & BDNF1600 ^②	(8) 2/0 + (2) #2 600kcmil	10.44	Cu/Al	3	BDTL32
BDNF2000 & BDNF3150	(8) #2 – 600kcmil	20.88	Cu/Al	12	BDTL28/2

BDTL32 Power distribution lugs eliminate the need to purchase a separate distribution block

Busbar connections

Description	For use on:	Weight (lbs)	Catalog number
Vertical mounting ^③	BDNF1600 – BDNF3150	46.2	BDBUS115
Vertical, back or edgewise mounting		31.0	BDBUS114

Auxiliary contacts^④

Description	For use on:	Weight (lbs)	AC thermal amp rating	AC rated voltage	Catalog number
1 N.O. + 1 N.C.	BDNF1200 – BDNF3150	0.20	10	600	BDAUX1
2 N.O. + 2 N.C.		0.26	10	600	BDAUX2
4 N.O. + 4 N.C.		0.40	10	600	BDAUX3
2 N.O.		0.18	10	600	BDAUX4
4 N.O.		0.25	10	600	BDAUX5
8 N.O.		0.40	10	600	BDAUX6

Terminal shrouds

Description	For use on:	Weight (lbs)	Catalog number
Includes one shroud for line or load side	BDNF1200	1.20	BDTS12

① Mounting depth is the distance from the outside of the door to the disconnect switch mounting plate. Shaft can be cut to desired length.

② A load side distribution lug eliminates the need to purchase, install and wire a separate distribution block.

③ Provided as standard with BDNF1600, BDNF2000 and BDNF3150.

for 1200A – 3150A Non-Fusible Disconnect Switches

Fusible

Non-Fused

Enclosed Fused

Enclosed Non-Fused

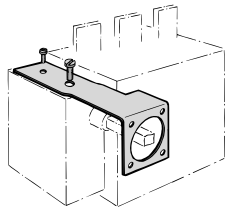

BDZX71

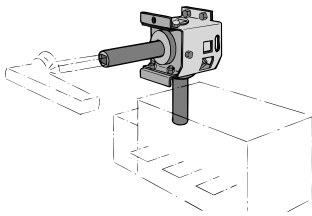

BDZX90

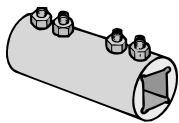

BDZW95

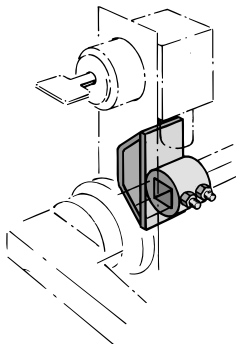

CDETL-ZW5

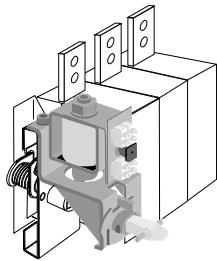

CDETL-ZT80

Handle support bracket

Description	For use on:	Weight (lbs)	Catalog number
Allows handle to be directly mounted to switch behind the door	BDNF1200 – BDNF3150	0.88	BDZX71

90° angle kit

Description	For use on:	Weight (lbs)	Catalog number
Converts switch mechanism from front operation to side operation	BDNF1200 – BDNF3150	4.63	BDZX90

Shaft extension coupler

Description	For use on:	Weight (lbs)	Catalog number
Joins two shafts together for applications where extended length is required	12mm shafts	0.26	BDZW95

Locking accessories

Description	For use on:	Weight (lbs)	Catalog number
Cam attachment for Kirk Key, Castell, Lowe & Fletcher and Ronis interlock. For adapting to the interlock system The interlock is not included.	12mm shafts	0.29	CDETL-ZW5
Electrical interlock Closed circuit principle for interlocking the switch movement. When the coil circuit is dead, A-types cannot be operated to ON-position and L-types cannot be operated to ON- or OFF-position. Coil voltages 110VAC, 220VAC, 24VDC, 48VDC, 60 VDC, 110VDC, 220VDC, P = 15W U = 0.7 – 1.1 Un (U= coil voltage, Un = nominal voltage)	BDNF1200 – BDNF3150	2.42	CDETL-ZT80A/★ CDETL-ZT80L/★



★ = Coil voltage

for 1200A – 3150A Non-Fusible Disconnect Switches

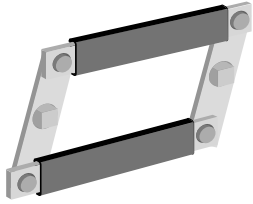

BDZW9

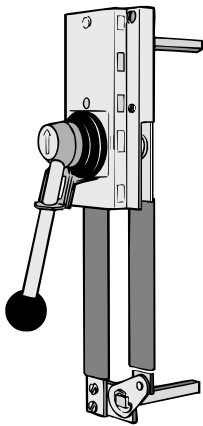

BDZW12

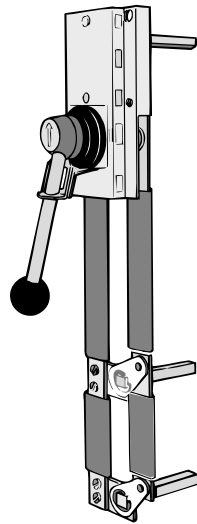

BDZW13

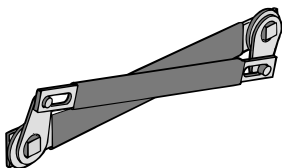

BDZW15

Conversion mechanisms

- Switches are not included

Description	For use on:	Weight (lbs)	Catalog number
6 or 8 pole Transfer Bypass	BDNF1200	2.42	BDZW9
		10.1	BDZW12
		8.81	BDZW13
Mechanical interlock	BDNF1200 – BDNF3150	2.64	BDZW15

6 or 8 pole — BDZW9

6 (8) pole mechanism allows two switches controlled by one handle to open or close simultaneously. One shaft included. Equipment required for a complete installation:

- One conversion mechanism.
- Two disconnect switches
- One handle
- One additional shaft (Only one shaft is included with mechanism)

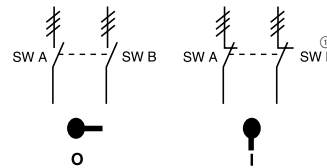

	POS. O	POS. I
SW. A	O	X
SW. B	O	X

X = Closed
O = Open

Transfer — BDZW12

Transfer mechanism manually transfers between two power sources using two switches and a center OFF position. A 3 position handle is included. Shafts included.

Equipment required for a complete installation:

- One conversion mechanism
- Two disconnect switches

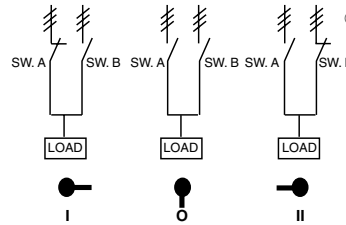

	POS. I	POS. O	POS. II
SW. A	X	O	O
SW. B	O	O	X

X = Closed
O = Open

Bypass — BDZW13

Bypass mechanism operates three switches: Two switches in series and one changeover switch to allow power bypass. A 3 position handle is included. Shafts included.

Equipment required for a complete installation:

- One conversion mechanism
- Three disconnect switches

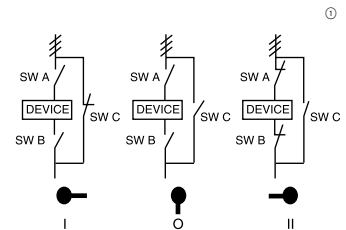

	POS. I	POS. O	POS. II
SW. A	O	O	X
SW. B	O	O	X
SW. C	X	O	O

X = Closed
O = Open

Mechanical interlock — BDZW15

Mechanical interlock mechanism prevents both switches from being in the "ON" position at the same time. Handles are not included.

Equipment required for a complete installation:

- One conversion mechanism
- Two disconnect switches
- Two shafts
- Two handles

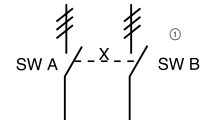

	SW. A POS. I	SW. B POS. I
SW. A	X	O
SW. B	O	X

X = Closed
O = Open

① ≡ Three poles

Fusible

Non-Fused

Enclosed Fused

Enclosed Non-Fused

30A – 800A^①

For a complete assembly, please select one of each:

- 1 switch
- 1 handle
- 1 shaft
- 1 terminal lug kit

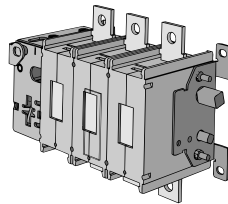

BDFLNF200A-S



BDS240



BDH110SH

Fusible

Non-Fused

Enclosed Fused

Enclosed Non-Fused



BDFLNF30-S



BDH107SH

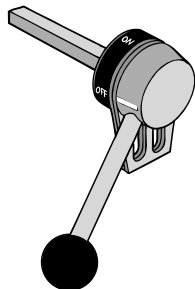

BDZX74



CDS67P
BDS240
BDS325



BDTL24



BDTL25



BDTL26



BDTL27

Side operated switches – 3 pole

UL general purpose amp rating	IEC AC21 amp rating	Maximum horsepower rating					Weight (lbs)	Catalog number
		Three phase						
		200V	208V	240V	480V	600V		
30	32	5	7.5	7.5	15	20	1.90	BDFLNF30-S
60	63	15	15	15	30	50	3.90	BDFLNF60-S
100	125	25	25	30	60	75	4.50	BDFLNF100-S
175	200	30	30	40	75	100	6.61	BDFLNF175-S
200	250	60	60	75	150	200	6.61	BDFLNF200A-S
400	630	100	100	125	250	350	13.66	BDFLNF400-S
600	800	150	150	200	400	500	13.66	BDFLNF600A-S

Handles

UL type	Color	Length inches/mm	Marking	Defeatable	Padlockable	Weight (lbs)	Catalog number
For use with BDFLNF30-S							
1, 12, 3R	Black	2.65/65	O/1 & Off/On	Yes	Yes	0.29	BDH106
1, 12, 3R	Red/Yellow	2.65/65	O/1 & Off/On	Yes	Yes	0.29	BDH107
For use with BDFLNF60-S – BDFLNF200A-S							
1, 12, 3R	Black	3.1/80	O/1 & Off/On	Yes	Yes	0.30	BDH110
1, 12, 3R	Red/Yellow	3.1/80	O/1 & Off/On	Yes	Yes	0.30	BDH111
For use with BDFLNF400-S – BDFLNF600A-S							
1, 12, 3R	Black	4.9/145	O/1 & Off/On	Yes	Yes	0.39	BDH114
1, 12, 3R	Red/Yellow	4.9/145	O/1 & Off/On	Yes	Yes	0.39	BDH115
1, 12, 3R	metal	4.9/145	Off/On	Yes	Yes	1.50	BDZX74

Shafts

For use with:	Length inches/mm	Description	Weight (lbs)	Catalog number
BDFLNF30-S	6.7/170	.20 x .20" (5 x 5mm)	0.08	CDS67P
BDFLNF60 – 100	8.3/210	.24 x .24" (6 x 6mm)	0.10	BDS210
BDFLNF175 – 200	9.5/240	.31 x .31" (8 x 8mm)	0.26	BDS240
BDFLNF400-S – 600A-S	12.8/325	.47 X .47" (12 X 12mm)	0.90	BDS325

Terminal lug kits

For use on:	Wire size	Weight (lbs)	Wire type	Lugs per kit	Catalog number
BDFLNF30-S	#14 – 4	—	Cu	—	Integral
BDFLNF60-S	#14 – 4	—	Cu	—	Integral
BDFLNF100-S	#14 – 2/0	0.43	Cu/Al	6	BDTL24
BDFLNF175-S	#6 – 300 kcmil	0.93	Cu/Al	6	BDTL25
BDFLNF200A-S	#6 – 300 kcmil	0.93	Cu/Al	6	BDTL25
BDFLNF400-S	#2 – 600 kcmil	3.520	Cu/Al	6	BDTL26
BDFLNF600A-S	(2) #2 – 600 kcmil	4.62	Cu/Al	6	BDTL27

① Side operated switches available through 800A as IEC rated.

30A – 200A

For a complete assembly, please select one of each:

- 1 switch
- 1 handle
- 1 shaft
- 1 terminal lug kit

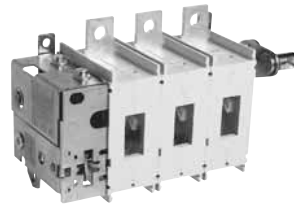

BDFLNF200A-F



BDFHS12



BDFHNHS12



BDTL25

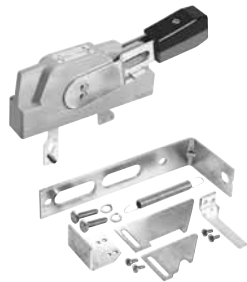

BDFHNHS12



BDFHS12



BDTL24



BDTL25

UL Listed
CSA Approved
IEC Rated
CE Marked

Flange operated switches – 3 pole

UL general purpose amp rating	IEC AC21 amp rating	Maximum horsepower rating					Weight (lbs)	Catalog number
		Three phase						
		200V	208V	240V	480V	600V		
30	40	10	10	10	20	30	2.80	BDFLNF30-F
60	63	20	20	20	40	40	3.90	BDFLNF60-F
100	115	25	25	25	50	40	4.50	BDFLNF100-F
200	250	60	60	75	150	200	6.61	BDFLNF200A-F

Flange handles

NEMA/UL type	Color	Length inches/mm	Marking	Defeatable	Padlockable	Weight (lbs)	Catalog number
1, 3R, 12	Metal	6.9/175	O/I & OFF/ON	Yes	Yes	3.52	BDFHNHS12
4, 4X	Metal	6.9/175	O/I & OFF/ON	Yes	Yes	3.52	BDFHNHS4

Shafts

Shaft length inches	Weight (lbs)	Catalog number
12	0.39	BDFHS12
17	0.55	BDFHS17
22.5	0.73	BDFHS22

Terminal lug kits

For use on:	Wire size	Kit weight (lbs)	Wire type	Terminal lugs per kit	Catalog number
BDFLNF30-F BDFLNF60-F BDFLNF100-F	#14 – #4 #14 – #4 #14 – 2/0	—	Cu	—	Standard BDTL24
BDFLNF200A-F	#6 – 300 kcmil	0.93	Cu/Al	6	BDTL25

Door hardware – NEMA 12

Description	Weight (lbs)	Catalog number
Safety door latch, 2 point with 6" handle.	1.92	BBDHK
Roller for 3 point latch, add to BBDHK	.39	BD3RL

Fusible

Non-Fused

Enclosed Fused

Enclosed Non-Fused

for Non-Fusible Disconnect Switches

CDNF16 – CDFN160

UL & CSA

Catalog number	3 pole	CDNF16	CDNF25	CDNF32	CDNF45	CDNF63	CDNF30	CDNF60	CDNF100	CDNF160	
Approvals ^①	2 pole 3 pole 4 pole	N/A UL508 & IEC UL508 & IEC	N/A UL508 & IEC UL508 & IEC	N/A UL508 & IEC UL508 & IEC	N/A UL508 & IEC UL508 & IEC	N/A UL508 & IEC UL508 & IEC	N/A UL98 & IEC UL98 & IEC	N/A UL98 & IEC UL98 & IEC	N/A UL98 & IEC UL98 & IEC	UL98 & IEC UL98 & IEC UL98 & IEC	
General purpose amp rating pf = 0.7 – 0.8	-40° to 40°C A	16	25	40	60	80	30	60	100	125	
Max. operating voltage	V	600	600	600	600	600	600	600	600	600	
Max. horsepower rating/motor FLA current, pf = 0.4 – 0.5											
Three phase	200V – 208V 240V 480V 600V	HP/A HP/A HP/A HP/A	3/10.6 5/15.2 10/14.0 10/11.0	7.5/24.2 7.5/22.0 15/21.0 20/22.0	10/30.8 10/28.0 20/27.0 25/27.0	15/46.2 15/42.0 30/40.0 30/32.0	20/60.0 20/54.0 40/52.0 40/41.0	10/30.8 10/28.0 20/27.0 30/32.0	20/60.0 20/54.0 40/52.0 40/41.0	25/75.0 30/80.0 50/65.0 50/52.0	30/88.0 30/80.0 60/77.0 75/77.0
Single phase	120V 240V	HP/A HP/A	0.5/9.8 1.5/10.0	0.75/13.8 2/12.0	1/16.0 3/17.0	2/24.0 5/28.0	2/24.0 5/28.0	2/24.0 5/28.0	3/34.0 7.5/40.0	5/56.0 15/68.0	7.5/80 20/88.0
Short circuit rating with fuse											
Fuse type CC	kA	10	10	10	100	100	50	50	50	—	
Fuse type J	kA	10	10	10	100	100	50	25	25	100	
Fuse type T	kA	10	10	10	100	100	50	25	25	—	
Fuse type RK1	kA	10	10	10	—	—	—	—	—	—	
Fuse type RK5	kA	5	5	5	5	10	5	—	—	—	
Fuse type L	kA	—	—	—	—	—	—	—	—	—	
Fuse type H	kA	—	—	—	5	5	—	—	—	—	
Fuse size	A	30	60	30	60	100	150	60	100	200	
Short circuit rating with MCCB	kA	—	—	—	—	—	—	—	—	25	
Endurances											
Min. Electrical endurance, pf = 0.75 – 0.80	operation cycles	6000	6000	6000	6000	6000	6000	6000	6000	6000	
Min. Electrical endurance, pf = 0.40 – 0.50	operation cycles	1000	1000	1000	1000	1000	②	②	②	②	
Mechanical endurance	operations	20,000	20,000	20,000	20,000	20,000	20,000	20,000	20,000	16,000	
Physical characteristics											
Weight, switches	3 pole 4 pole	lb	0.24 0.33	0.24 0.33	0.24 0.33	0.59 0.77	0.59 0.77	0.79 1.10	0.79 1.10	0.79 1.10	2.42 2.86
Dimension, switches	3 pole	H in W in D in	2.68 1.38 2.20	2.68 1.38 2.20	2.68 1.38 2.20	3.60 2.07 2.85	3.60 2.07 2.85	3.94 2.76 2.95	3.94 2.76 2.95	3.94 2.76 2.95	5.00 4.96 2.93
Shaft size — square □		in mm	.20 x .20 5 x 5	.20 x .20 5 x 5	.20 x .20 5 x 5	.20 x .20 5 x 5	.20 x .20 5 x 5	.20 x .20 5 x 5	.20 x .20 5 x 5	.20 x .20 5 x 5	.24 x .24 6 x 6
Switch operating torque for rotary 3 pole switches		lb. in.	8.8	8.8	8.8	10.5	10.5	17.5	17.5	17.5	52.5
Terminal lug kits											
Wire range	AWG	#18 – 8	#18 – 8	#18 – 8	#14 – 4	#14 – 1	#14 – 4	#14 – 4	#8 – 1/0	#8 – 1/0	
Torque:											
Wire tightening	lb. in.	7	7	7	18	18	55	55	55	70	
Lug mounting	lb. in.	Integral	Integral	Integral	Integral	Integral	Integral	Integral	Integral	Integral	
Auxiliary contacts											
NEMA ratings, AC		CDAUX_ _ A600	CDAUX_ _ A600	CDAUX_ _ A600	CDAUX_ _ A600	CDAUX_ _ A600	CDAUX_ _ A600	CDAUX_ _ A600	CDAUX_ _ A600	CDAUX_ _ A600	
AC rated voltage	VAC	600	600	600	600	600	600	600	600	600	
AC thermal rated current	A	10	10	10	10	10	10	10	10	10	
AC maximum volt-ampere making	VA	7200	7200	7200	7200	7200	7200	7200	7200	7200	
AC maximum volt-ampere breaking	VA	720	720	720	720	720	720	720	720	720	
NEMA ratings, DC		R300	R300	R300	R300	R300	R300	R300	R300	P600	
DC rated voltage	VDC	300	300	300	300	300	300	300	300	600	
DC thermal rated current	A	1	1	1	1	1	1	1	1	5	
DC maximum make-break	VA	28	28	28	28	28	28	28	28	138	
Torque:											
Wire tightening	lb. in.	7	7	7	7	7	7	7	7	7	
Wire range	AWG	#18 – 14	#18 – 14	#18 – 14	#18 – 14	#18 – 14	#18 – 14	#18 – 14	#18 – 14	#22 – 14	

① UL Listed switches are also CSA Approved.

② UL98 overload test, 50 operations, pf 0.40 – 0.50 at 2x FLA.

for Non-Fusible Disconnect Switches
BDNF175 – BDNF3150

UL & CSA

Catalog number	3 pole	BDNF175	BDNF200A	BDNF400	BDNF600A	BDNF800A	BDNF1200	BDNF1600	BDNF2000	BDNF3150 ①
Approvals ^②	2 pole 3 pole 4 pole	UL508 & IEC UL508 & IEC IEC	UL98 & IEC UL98 & IEC IEC	UL98 & IEC UL98 & IEC UL98 & IEC	UL98 & IEC UL98 & IEC UL98 & IEC	UL98 & IEC UL98 & IEC UL98 & IEC	UL98 & IEC UL98 & IEC UL98 & IEC	UL98 & IEC UL98 & IEC UL98 & IEC	UL98 & IEC UL98 & IEC UL98 & IEC	IEC IEC IEC
General purpose amp rating pf = 0.7 – 0.8	-40° to 40°C A	175	200	400	600	800	1200	1600	2000	3150
Max. operating voltage	V	600	600	600	600	600	600	600	480	—
Max. horsepower rating/Max. motor FLA current, pf = 0.4 – 0.5										
Three phase	200 – 208V HP/A 240V HP/A 480V HP/A 600V HP/A	30/88.0 40/104.0 75/96.0 100/99.0	60/160.0 75/192.0 150/180.0 200/192.0	100/273.0 125/312.0 250/302.0 350/336.0	150/396.0 200/480.0 400/477.0 500/472.0	200/528.0 250/602.0 500/590.0 600/576	— — — —	— — — —	— — — —	— — — —
Single phase	120V HP/A 240V HP/A	— —	— —	— —	— —	— —	— —	— —	— —	— —
Short circuit rating with fuse										
Fuse type CC	kA	—	—	—	—	—	—	—	—	—
Fuse type J	kA	100	—	—	—	—	—	—	—	—
Fuse type T	kA	—	—	—	—	—	—	—	—	—
Fuse type RK1	kA	—	—	—	—	—	—	—	—	—
Fuse type RK5	kA	—	100	100	100	—	—	—	—	—
Fuse type L	kA	—	—	—	—	—	100	100	100	—
Fuse type H	kA	—	—	—	—	—	—	—	—	—
Fuse size	A	200	200	600	600	1200	1200	2000	2000	—
Short circuit rating with MCCB	kA	25	25	50	50	50	50	65	65	—
Endurances										
Min. Electrical endurance, pf = 0.75 – 0.80	operation cycles	6000	6000	1000	1000	500	500	500	500	400
Min. Electrical endurance, pf = 0.40 – 0.50	operation cycles	1000	②	②	②	②	②	②	②	②
Mechanical endurance	operations	16,000	16,000	10,000	10,000	10,000	10,000	6000	6000	6000
Physical characteristics										
Weight, switches	3 pole lb 4 pole lb	6.61 8.15	6.61 8.15	13.66 16.74	13.66 16.74	35.9 45.15	38.55 49.56	127.7 149.7	127.7 149.7	127.7 149.7
Dimension, switches	3 pole H in W in D in	8.35 7.83 4.55	8.35 8.62 4.55	11.81 10.24 5.12	11.77 11.93 5.12	19.09 14.29 4.92	19.09 14.29 4.92	25.04 18.43 10.67	25.04 18.43 10.67	25.04 18.43 10.67
Shaft size — square	□ in mm	.31 X .31 8 X 8	.31 X .31 8 X 8	.47 X .47 12 X 12	.47 X .47 12 X 12	.47 X .47 12 X 12	.47 X .47 12 X 12	.47 X .47 12 X 12	.47 X .47 12 X 12	.47 X .47 12 X 12
Switch operating torque for rotary 3 pole switches	lb. in.	71.5	71.5	184	184	184	184	438	438	438
Terminal lug kits										
Wire range	AWG	#6 – 300kcmil ^③	#6-300kcmil ^③	#2-600kcmil	(2)#2-600kcmil	(2)#2-600kcmil	(4)#2-600kcmil	(4)#2-600kcmil	(8)#2-600kcmil	(8)#2-600kcmil
Torque:										
Wire tightening	lb. in.	375	375	500	375	500	375	375	375	375
Lug mounting	lb. in.	230	230	480	500	230	230	230	230	230
Auxiliary contacts										
NEMA ratings, AC										
AC rated voltage	VAC	600	600	600	600	600	600	600	600	600
AC thermal rated current	A	10	10	10	10	10	10	10	10	10
AC maximum volt-ampere making	VA	7200	7200	7200	7200	7200	7200	7200	7200	7200
AC maximum volt-ampere breaking	VA	720	720	720	720	720	720	720	720	720
NEMA ratings, DC										
DC rated voltage	VDC	600	600	600	600	600	600	600	600	600
DC thermal rated current	A	5	5	5	5	5	5	5	5	5
DC maximum make-break	VA	138	138	138	138	138	138	138	138	138
Torque:										
Wire tightening	lb. in	7	7	7	7	7	7	7	7	7
Wire range	AWG	#22 – #14	#22 – #14	#22 – #14	#22 – #14	#22 – #14	#22 – #14	#22 – #14	#22 – #14	#22 – #14

① UL Listed switches are also CSA Approved.
 ② UL98 overload test, 50 operations, pf 0.40 – 0.50 at 2x FLA.
 ③ Multi-tap lug available.
 ④ IEC rated only.

Fusible

Non-Fused

Enclosed Fused

Enclosed Non-Fused

for Non-Fusible Disconnect Switches
CDNF16 – CDNF160

IEC

Catalog number	3 pole		CDNF16	CDNF25	CDNF32	CDNF45	CDNF63	CDNF30	CDNF60	CDNF100	CDNF160
Rated insulation and operation voltage, AC20 and DC20 ^① V	40°C	750	750	750	750	750	750	750	750	750	
Rated impulse withstand voltage		kV	8	8	8	8	8	8	8	8	12
Rated thermal current, I _m											
AC 20/DC 20	open ^②	A	25	32	40	63	80	40	63	115	200
	40°C enclosed	A	25	32	40	63	80	40	63	115	160
	60°C enclosed	A	25	32	40	63	80	40	63	115	160
Rated operational currents											
AC 21A	≤500V	A	16	25	32	63	80	40	63	100	160 ^③
	≤690V	A	16	25	32	63	80	40	63	100	160 ^③
	≤1000V ^①	A	—	—	—	—	—	—	—	—	—
AC 22A	≤500V	A	16	25	32	63	80	40	63	100	160 ^③
	≤690V	A	16	25	32	63	80	40	63	100	160 ^③
	≤1000V ^①	A	—	—	—	—	—	—	—	—	—
AC 23A	≤415V	A	16	20	23	45	75	40	63	80	135
	≤500V	A	16	20	23	45	58	40	63	60	125
	≤690V	A	10	11	12	20	20	40	40	40	80
	≤1000V ^①	A	—	—	—	—	—	—	—	—	—
Rated operational currents/poles in series											
DC21A	48V	A	16/1	25/1	32/1	45/1	63/1	40/1	63/1	100/1	160/1
	110V	A	16/2	25/2	32/2	45/2	63/2	40/2	63/2	100/2	160/1
	220V	A	16/3	25/3	32/3	45/4	63/4	40/4	63/4	100/4	160/2
	440V	A	16/4	25/6	32/6	⊕	⊕	⊕	⊕	⊕	160/3
	750V	A	16/8	25/8	32/8	⊕	⊕	⊕	⊕	⊕	160/4
DC22A	48V	A	16/1	25/1	32/1	45/1	63/1	40/1	63/1	100/1	160/1
	110V	A	16/2	25/2	32/2	45/2	63/2	40/2	63/2	100/2	160/1
	220V	A	16/3	25/3	32/4	45/4	63/4	40/4	63/4	63/4	160/2
	440V	A	16/6	25/8	⊕	⊕	⊕	⊕	⊕	⊕	160/3
	750V	A	16/8	25/8	⊕	⊕	⊕	⊕	⊕	⊕	⊕
DC23A	48V	A	16/1	25/1	32/1	45/1	63/1	40/1	63/1	100/1	160/1
	110V	A	16/2	25/2	32/2	45/2	63/2	40/2	63/2	100/2	160/1
	220V	A	16/4	25/4	32/4	45/4	63/4	40/4	63/4	63/4	160/2
	440V	A	10/4	⊕	⊕	⊕	⊕	⊕	⊕	⊕	160/3
	750V	A	16/8	⊕	⊕	⊕	⊕	⊕	⊕	⊕	⊕
Rated operational power											
AC23A	230V	kW	3	4	5.5	11	22	7.5	11	22	45
	400/415V	kW	7.5	9	11	22	37	15	18.5	37	75
	500V	kW	7.5	9	11	22	37	15	18.5	37	75
	690V	kW	7.5	9	11	15	18.5	15	15	37	75
Short-circuit current		kA	50	50	50	50	50	50	50	50	50
with back-up fuses of size ^① A		A	32	40	63	80	100	100	100	200	



Figure 1



Figure 2



Figure 3

① 1000V, IEC 408.
 ② The ambient air temperature does not exceed +40°C and its average over a period of 24 hours does not exceed +35°C according to IEC 947.
 ③ IEC 947-3, utilization category B, infrequent operation.
 ④ Not available at time of printing, please consult factory.

for Non-Fusible Disconnect Switches
BDNF175 – BDNF3150

IEC

Catalog number	3 pole		BDNF175	BDNF200A	BDNF400	BDNF600A	BDNF800A	BDNF1200	BDNF1600	BDNF2000	BDNF3150
Rated insulation and operational voltage, AC20 and DC20 ^①	V	40°C	1000	1000	1000	1000	1000	1000	1000	1000	
Rated impulse withstand voltage	kV		12	12	12	12	8	8	8	8	8
Rated thermal current, I _{th}											
AC 20/DC 20	open ^② A		315	315	630	800	1250	1600	2500	2500	3150
	40°C enclosed A		270	270	630	720	1250	1600	2300	2300	2600
	60°C enclosed A		220	220	630	720	1250	1600	2300	2300	2600
Rated operational currents											
AC 21A	≤500V A		250	250	630	800	1250	1600	2500^③	2500^③	3150^③
	≤690V A		250	250	630	800	1250	1600	2500 ^③	2500 ^③	3150 ^③
	≤1000V ^① A		250	250	630	630	—	—	—	—	—
AC 22A	≤500V A		250	250	630	800	1250	1600	1600 ^③	1600 ^③	1600 ^③
	≤690V A		250	250	630	800	—	—	—	—	—
	≤1000V ^① A		250	250	400	400	—	—	—	—	—
AC 23A	≤415V A		250	250	630	720	800	800	800 ^③	800 ^③	800 ^③
	≤500V A		250	250	580	600	800	800	800 ^③	800 ^③	800 ^③
	≤690V A		250	250	350	350	—	—	—	—	—
	≤1000V ^① A		125	125	200	200	—	—	—	—	—
Rated operational currents/poles in series											
DC21A	48V A		250	250	630/2	800/2	1250/2	1600/2	2500/2	2500/2	3150/2
	110V A		250	250	630/2	800/2	1250/2	1600/2	2500/2	2500/2	3150/2
	220V A		250/2	250/2	630/2	800/2	1250/3	1600/2	2500/2	2500/2	3150/2
	440V A		250/3	250/3	630/3	800/3	—	1600/3	2500/3	2500/3	3150/2
	750V A		250/4	250/4	—	—	—	—	—	—	—
DC22A	48V A		250	250	630/2	800/2	1250/2	1600/2	2500/2	2500/2	3150/2
	110V A		250	250	630/2	800/2	1250/2	1600/2	2500/2	2500/2	3150/2
	220V A		250/2	250/2	630/2	800/2	1250/2	1600/2	2500/2	2500/2	3150/2
	440V A		250/3	250/3	630/3	800/3	—	—	—	—	—
	750V A		250/4	250/4	—	—	—	—	—	—	—
DC23A	48V A		250	250	630/2	—	—	—	—	—	—
	110V A		250	250	630/2	—	—	—	—	—	—
	220V A		250/2	250/2	630/2	—	—	—	—	—	—
	440V A		250/3	250/3	—	—	—	—	—	—	—
	750V A		250/4	250/4	—	—	—	—	—	—	—
Rated operational power											
AC23A	230V kW		75	75	180	200	250	250	250	250	250
	400/415V kW		132	132	315	355	400	400	400	400	400
	500V kW		160	160	355	400	450	450	450	450	450
	690V kW		200	200	355	355	—	—	—	—	—
Short-circuit current	kA		100	100	80	80	50	50 ^④	50 ^④	50 ^④	50 ^④
with back-up fuses of size ^①	A		400	630	800	1000	1250	1250	1250	1250	1250

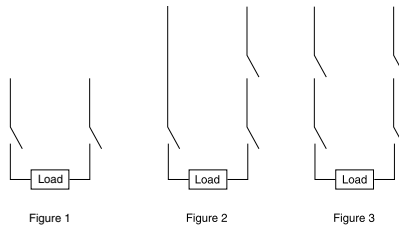

① 1000V, IEC 408.
 ② The ambient air temperature does not exceed +40°C and its average over a period of 24 hours does not exceed +35°C according to IEC 947.
 ③ IEC 947-3, utilization category B, infrequent operation.
 ④ Not available at time of printing, please consult factory.

Fusible

Non-Fused

Enclosed Fused

Enclosed Non-Fused

for Non-Fusible Disconnect Switches

CDNF16 – CDFN160

IEC

Catalog number	3 pole	CDNF16	CDNF25	CDNF32	CDNF45	CDNF63	CDNF30	CDNF60	CDNF100	CDNF160
Rated voltage, U ^e	V/V	415	415	415	415	415	415	415	415	415/690
Rated conditional short-circuit current	kA	50	50	50	50	50	50	50	50	80/50
Max. allowed fuse size, type OFAA	A	16	32	40	63	80	100	100	100	160/250
Max. allowed cut-off current, peak value	kA	4	4.3	4.6	8.3	11	9.2	9.2	9.2	21.0/21.6
Rated short-circuit making capacity, prospective peak value, I ^{cm} kA	0.7	0.7	0.7	1.4	1.4	3.6	3.6	3.6	12	
Rated short time withstand current, RMS I ^{CW} 0.2s	kA	—	—	—	—	—	—	—	—	7
RMS I ^{CW} 1.0s	kA	0.5	0.5	0.5	1	1	2.5	2.5	2.5	4
AC breaking capacity										
pf = 0.35										
≤415V	A	128	160	184	240	304	320	504	640	1080
≤500V	A	128	160	184	240	256	320	504	504	1000
≤690V	A	80	88	96	160	160	320	320	320	640
≤1000V ^①	A	—	—	—	—	—	—	—	—	—
DC breaking capacity/poles in series										
L/R = 15ms, 3 pole in series										
≤48V	A	64/1	100/1	128/1	180/1	252/1	160/1	252/1	400/1	640/1
≤110V	A	64/2	100/2	128/2	180/2	180/2	160/2	252/2	400/2	640/1
≤220V	A	64/3	100/4	128/4	180/4	180/4	160/4	252/4	252/4	640/2
≤440V	A	②	②	②	②	②	②	②	—	640/3
≤750V	A	②	②	②	②	②	②	②	—	—
Capacitor ratings	≤400/415V	kVar	②	②	②	②	②	②	②	②
Rated capacitor duty	kA	②	②	②	②	②	②	②	②	②
Physical characteristics										
Electrical endurance at rated operational current, pf = 0.65	operation cycles	3000	3000	3000	3000	3000	3000	3000	3000	1000
Mechanical endurance	operations	20,000	20,000	20,000	20,000	20,000	20,000	20,000	20,000	16,000
Weight	3 pole	kg	0.11	0.11	0.11	0.27	0.27	0.36	0.36	1.1
	4 pole	kg	0.15	0.15	0.15	0.35	0.35	0.5	0.5	1.3
Dimension 3 pole	H mm	68	68	68	91.5	91.5	100	100	100	127
	W mm	35	35	35	52.5	52.5	70	70	70	126
	D mm	56	56	56	72.5	72.5	75	75	75	74.5
Power loss per pole	W	0.3	0.6	1	1.4	2.8	1	1.6	4	6.5
Shaft size — square	mm	5 X 5	5 x 5	5 x 5	5 x 5	5 x 5	5 x 5	5 x 5	5 x 5	6 x 6
Switch operating torque for rotary 3 pole switches	Nm	1	1	1	1.2	1.2	2	2	2	6
Suitable conductor cross section Cu	mm ²	0.75 – 10	0.75 – 10	0.75 – 10	1.5 – 35	1.5 – 35	1.5 – 25	1.5 – 25	1.5 – 25	10 – 70
Bolt size		—	—	—	—	—	—	—	—	—
Auxiliary contacts		CDAUX_ _	CDAUX_ _	CDAUX_ _	CDAUX_ _	CDAUX_ _	CDAUX_ _	CDAUX_ _	CDAUX_ _	CDAUX_ _
Ratings according to IEC 9-47-5-1										
Rated voltage, U _i	VAC	690	690	690	690	690	690	690	690	690
Thermal current, I _m	A	16	16	16	16	16	16	16	16	10
AC12/DC12 I _a , A U _o = 120V	A	—	—	—	—	—	—	—	—	8/—
125V	A	—	—	—	—	—	—	—	—	—/1.1
240V	A	6 ^③	6 ^③	6 ^③	6 ^③	6 ^③	6 ^③	6 ^③	6 ^③	6/—
250V	A	—	—	—	—	—	—	—	—	—/0.55
400V	A	4 ^③	4 ^③	4 ^③	4 ^③	4 ^③	4 ^③	4 ^③	4 ^③	4/—
415V	A	—	—	—	—	—	—	—	—	4/—
440V	A	—	—	—	—	—	—	—	—	—/0.31
480V	A	—	—	—	—	—	—	—	—	3/—
500V	A	—	—	—	—	—	—	—	—	3/0.27
600V	A	—	—	—	—	—	—	—	—	—/0.2
690V	A	2 ^③	2 ^③	2 ^③	2 ^③	2 ^③	2 ^③	2 ^③	2 ^③	2/—

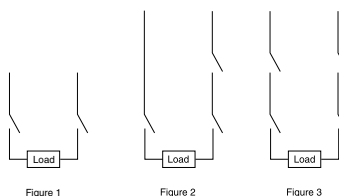

① 1000V, IEC 408.
 ② Not available at time of printing, please consult factory.
 ③ AC15, according to IEC947-5-1.

for Non-Fusible Disconnect Switches
BDNF175 – BDNF3150

IEC

Catalog number	3 pole	BDNF175	BDNF200A	BDNF400	BDNF600A	BDNF800A	BDNF1200	BDNF1600	BDNF2000	BDNF3150
Rated voltage, U _e	V/V	500/690	500/690	500/690	500/690	690	690	690	690	690
Rated conditional short-circuit current	kA	100/50	100/50	100/50	100/50	45	45	45	50	50
Max. allowed fuse size, type OFAA	A	400	400	800 ^①	800 ^②	—	—	—	—	—
Max. allowed cut-off current, peak value	kA	30	30	62	62	—	—	—	—	—
Rated short-circuit making capacity, prospective peak value, I _{cm}	kA	35	80	80	105	105	115	115	115	—
Rated short time withstand current, RMS I _{sw}	kA	17	17	38	38	100	100	110	110	110
	0.2s									
	1.0s	8	8	17	17	50 ^③	50 ^③	50 ^③	50 ^③	50 ^③
AC breaking capacity, pf = 0.35										
	≤415V	A	1600	2000	5760	5780	6400	6400	6400	6400
	≤500V	A	1600	2000	4800	4800	6400	6400	6400	6400
	≤690V	A	1600	2000	2800	2800	2500 ^④	2500 ^④	4800 ^⑤	4800 ^⑤
	≤1000V ^⑥	A	1000	1000	1200	1200	—	—	—	—
DC breaking capacity/poles in series, L/R = 15ms, 3 pole in series										
	48V	A	1260/1	1260/1	—	—	—	—	—	—
	110V	A	1260/1	1260/1	—	—	—	—	—	—
	220V	A	1260/2	1260/2	1600/2	2000/2	1900/2 ^④	2600/2 ^④	2600/2 ^④	2600/2 ^④
	440V	A	1260/1	1260	1600	2000	—	—	—	—
	750V	A	1260/1	1260/4	—	—	—	—	—	—
Capacitor ratings	400/415V	kVar	90	110	300	350	⑦	⑦	⑦	⑦
Rated capacitor duty		kA	135	170	450	500	⑦	⑦	⑦	⑦
Physical characteristics										
Electrical endurance at rated operational current, pf = 0.65	operation cycles		1000	1000	1000	500	500	500	100 ^⑧	100 ^⑧
Mechanical endurance	operations		16,000	16,000	10,000	10,000	10,000	10,000	6000	6000
Weight	3 pole	kg	3.0	3.0	6.2	6.2	16.3	17.5	37	37
	4 pole	kg	3.7	3.7	7.6	7.6	20.5	22.5	47	47
Dimension 3 pole	H	mm	212	300	299	485	485	636	636	636
	W	mm	199	219	260	303	363	363	468	468
	D	mm	115.5	115.5	130	130	125	125	271	271
Power loss per one pole		W	3.5	5.5	22	40	40	67	90	140
Shaft size — square		mm	8 x 8	8 x 8	12 x 12	12 x 12	12 x 12	12 x 12	12 x 12	12 x 12
Switch operating torque for rotary 3 pole switches		Nm	8.2	8.2	21	21	21	21	50	50
Suitable conductor cross section Cu		mm ²	—	—	—	—	—	—	—	—
Bolt size			8x25	10 x 30	12 x 40	12 x 40	12 x 60	12 x 60	12 x 60	12 x 60
Auxiliary contacts			BDAUX_ _	BDAUX_ _	BDAUX_ _	BDAUX_ _	BDAUX_ _	BDAUX_ _	BDAUX_ _	BDAUX_ _
Ratings according to IEC 947-5-1										
Rated voltage, U _i	VAC		690	690	690	690	690	690	690	690
Thermal rated current, I _n	A		10	10	10	10	10	10	10	10
AC12/DC12 I _n , A U _e =										
	120V	A	8/—	8/—	8/—	8/—	8/—	8/—	8/—	8/—
	125V	A	—/1.1	—/1.1	—/1.1	—/1.1	—/1.1	—/1.1	—/1.1	—/1.1
	240V	A	6/—	6/—	6/—	6/—	6/—	6/—	6/—	6/—
	250V	A	—/0.55	—/0.55	—/0.55	—/0.55	—/0.55	—/0.55	—/0.55	—/0.55
	400V	A	4/—	4/—	4/—	4/—	4/—	4/—	4/—	4/—
	415V	A	4/—	4/—	4/—	4/—	4/—	4/—	4/—	4/—
	440V	A	—/0.31	—/0.31	—/0.31	—/0.31	—/0.31	—/0.31	—/0.31	—/0.31
	480V	A	3/—	3/—	3/—	3/—	3/—	3/—	3/—	3/—
	500V	A	3/0.27	3/0.27	3/0.27	3/0.27	3/0.27	3/0.27	3/0.27	3/0.27
	600V	A	—/0.2	—/0.2	—/0.2	—/0.2	—/0.2	—/0.2	—/0.2	—/0.2
	690V	A	2/—	2/—	2/—	2/—	2/—	2/—	2/—	2/—

- ① 1000V, IEC 408.
- ② Not available at time of printing, please consult factory.
- ③ Size 4.
- ④ L/R = 2.5 mS.
- ⑤ Maximum distance between busbar support and switch terminal 70mm.
- ⑥ pf 0.95.
- ⑦ pf 0.65.
- ⑧ IEC 947-3, utilization category B, infrequent operation.

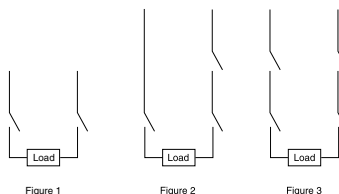

Fusible

Non-Fused

Enclosed Fused

Enclosed Non-Fused

for Non-Fusible Disconnect Switches

CDNF16 — CDNF100

CDNF16, CDNF25, CDNF32 — base & DIN rail mounted switch

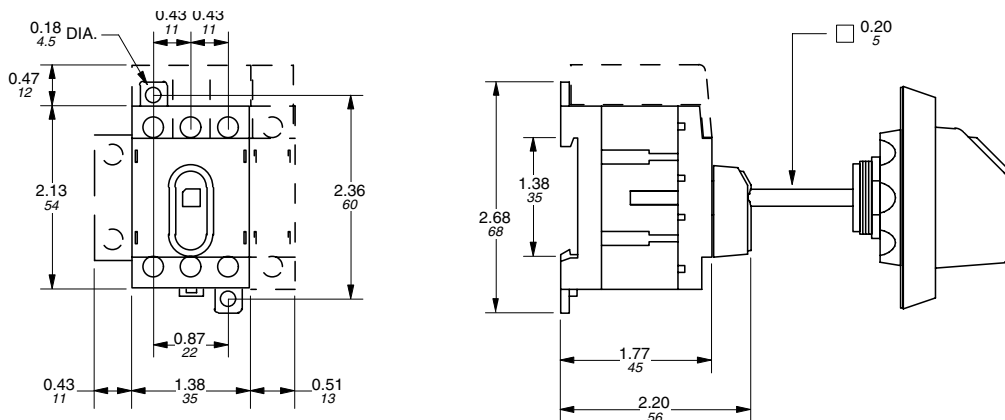

Fusible

CDNF45, CDNF63 — base & DIN rail mounted switch

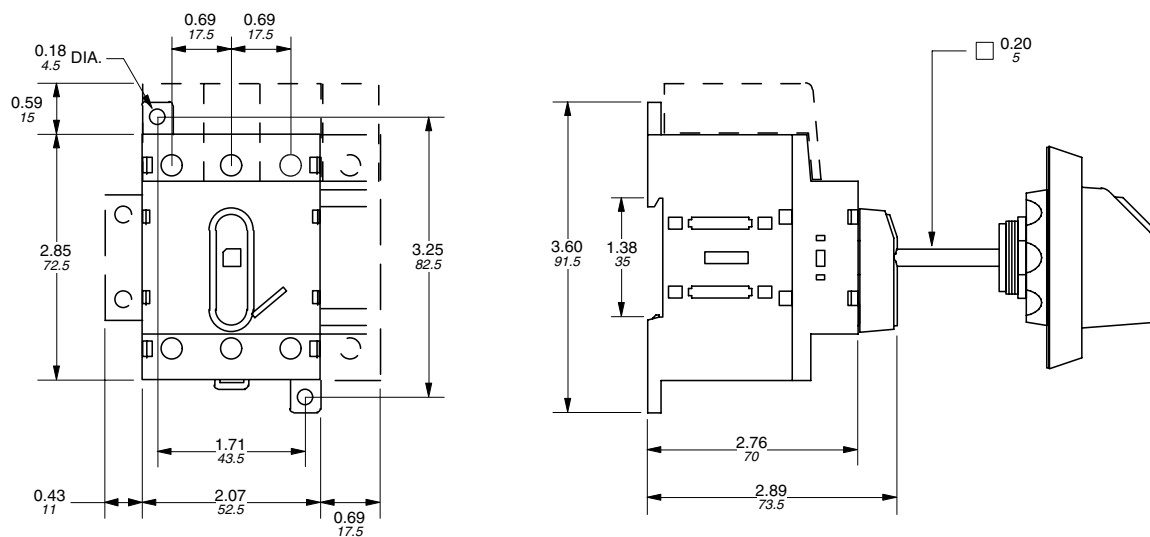

Non-Fused

Enclosed Fused

CDNF30, CDNF60, CDNF100 — base & DIN rail mounted switch

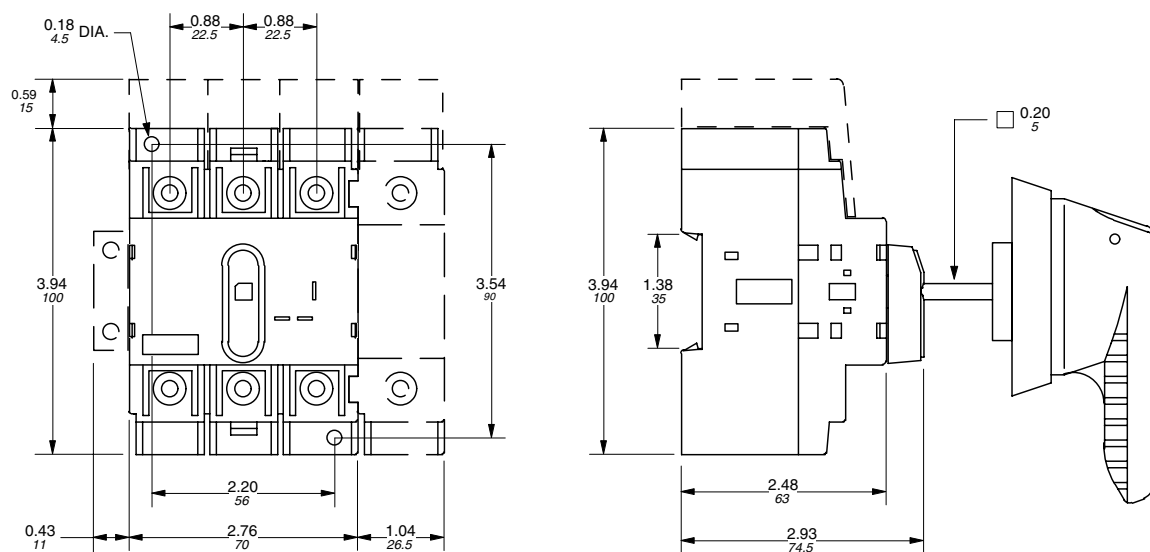

Enclosed Non-Fused

for Non-Fusible Disconnect Switches
CDNF16D — CDNF100D

CDNF16D, CDNF25D, CDNF32D — door mounted switch

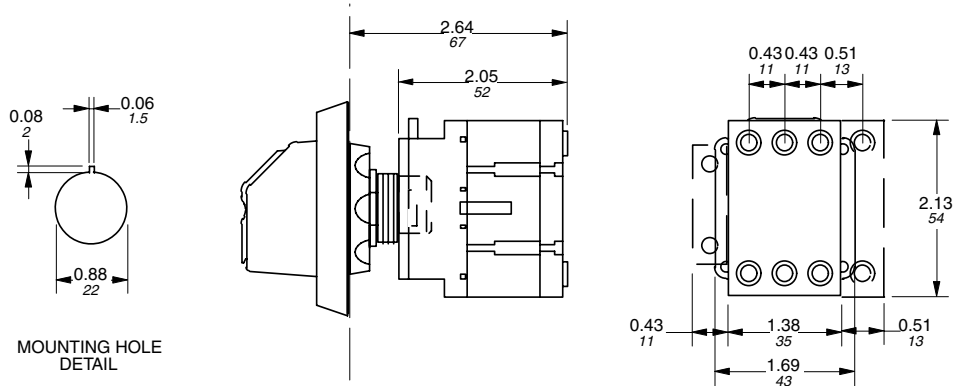

CDNF45D, CDNF63D — door mounted switch

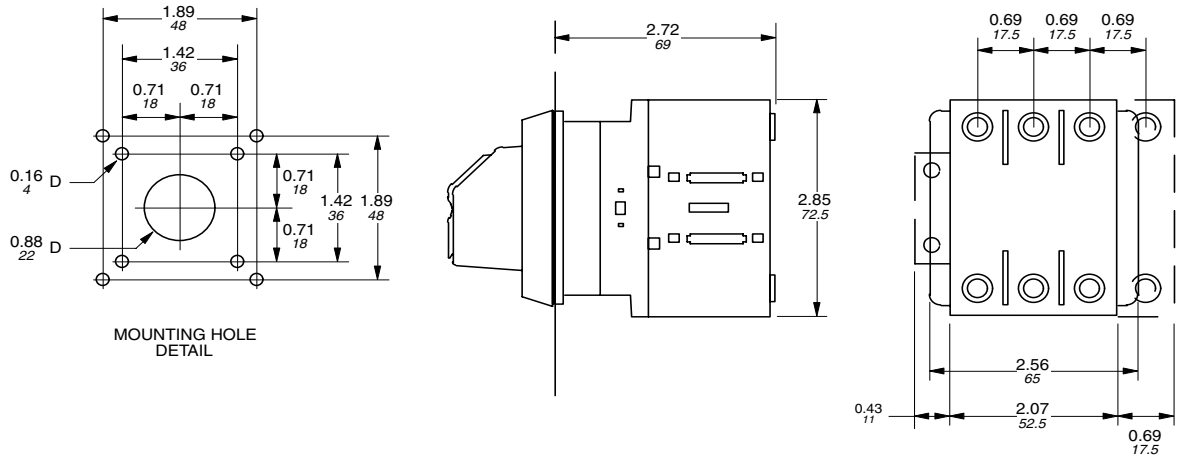

CDNF30D, CDNF60D, CDNF100D — door mounted switch

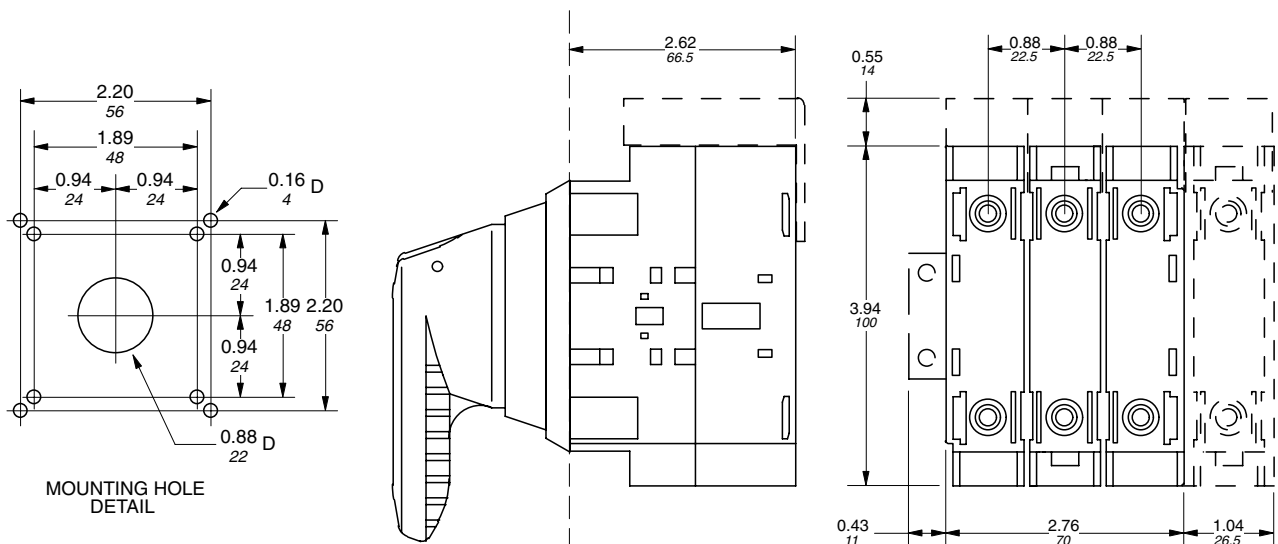

Fusible

Non-Fused

Enclosed Fused

Enclosed Non-Fused

for Non-Fusible Disconnect Switches
CDNF175A — BDNF200A

CDNF175A

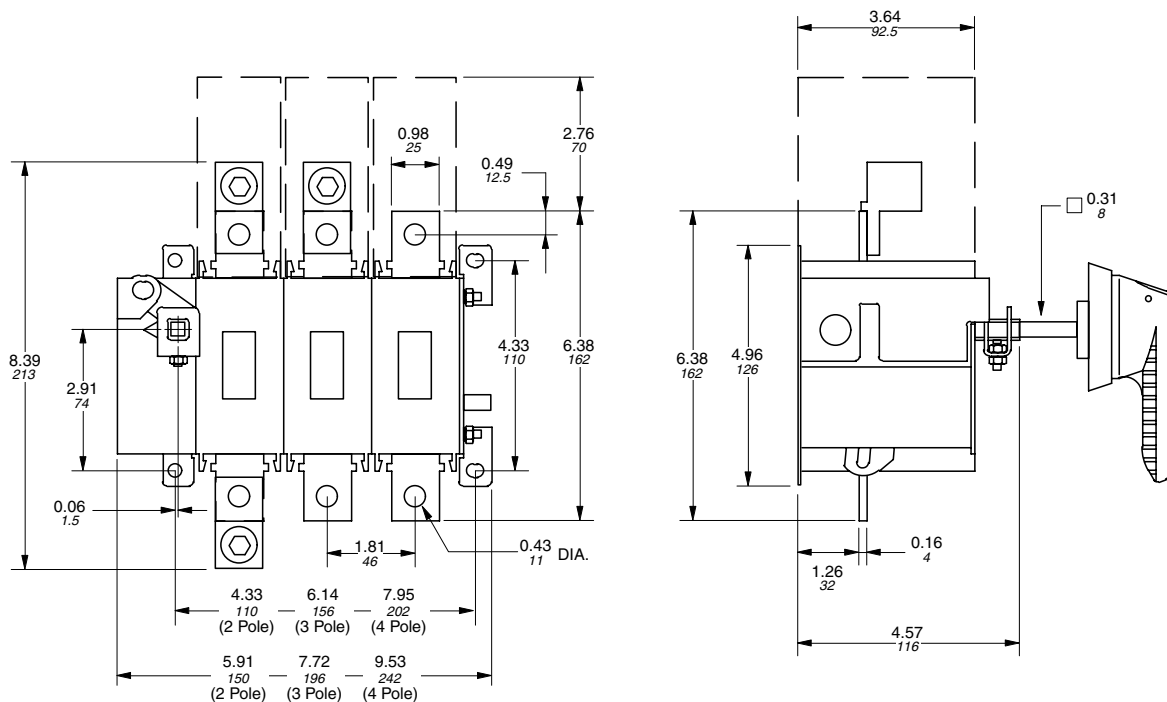

BDNF200A

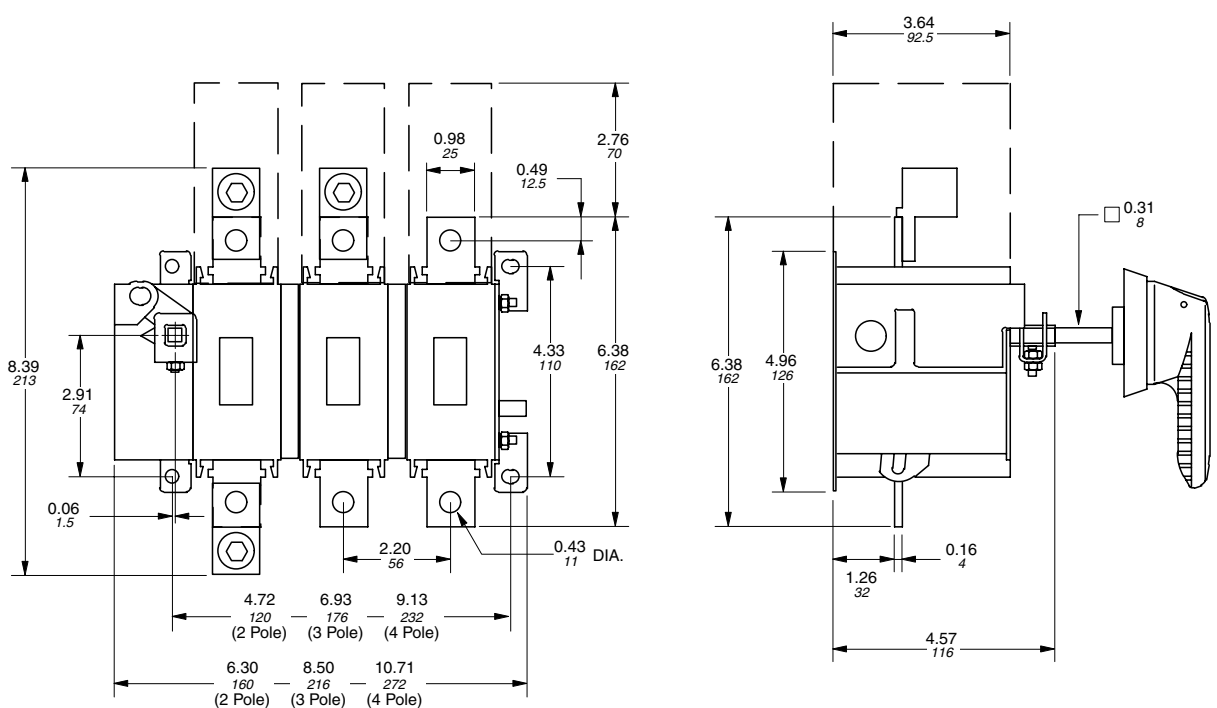

Fusible

Non-Fused

Enclosed Fused

Enclosed Non-Fused

for Non-Fusible Disconnect Switches
BDNF800A — BDNF1200

BDNF800A

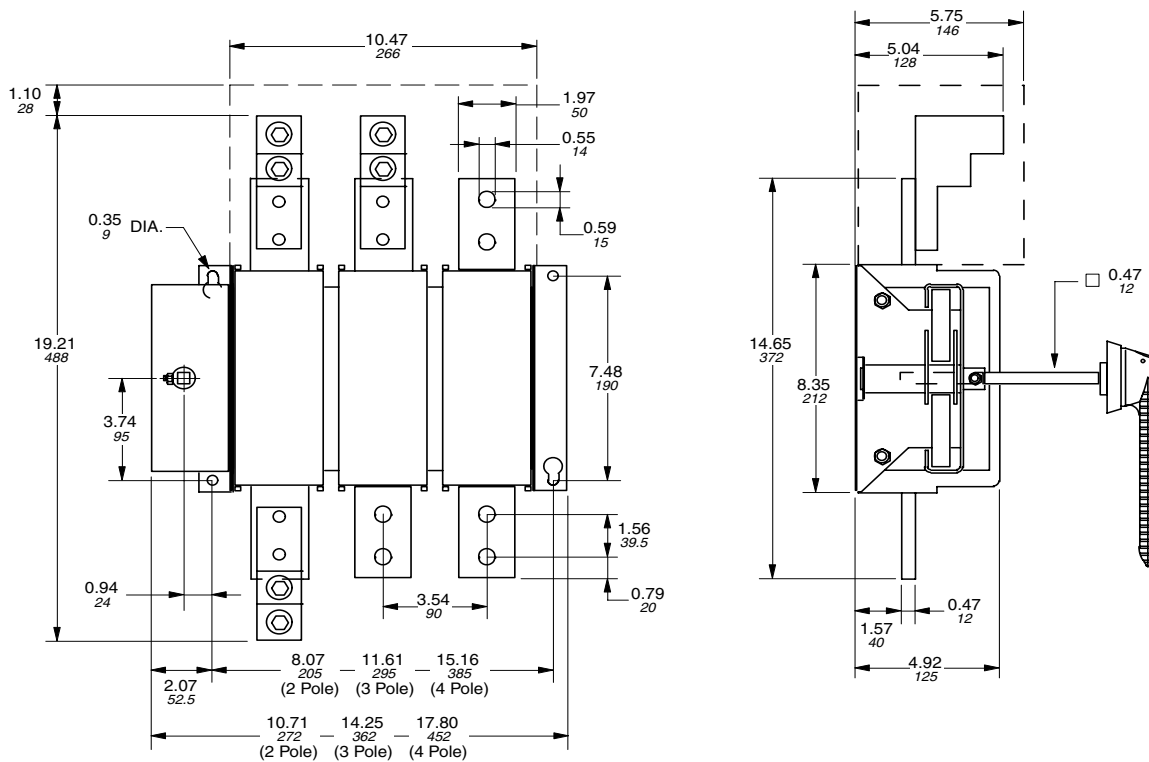

BDNF1200

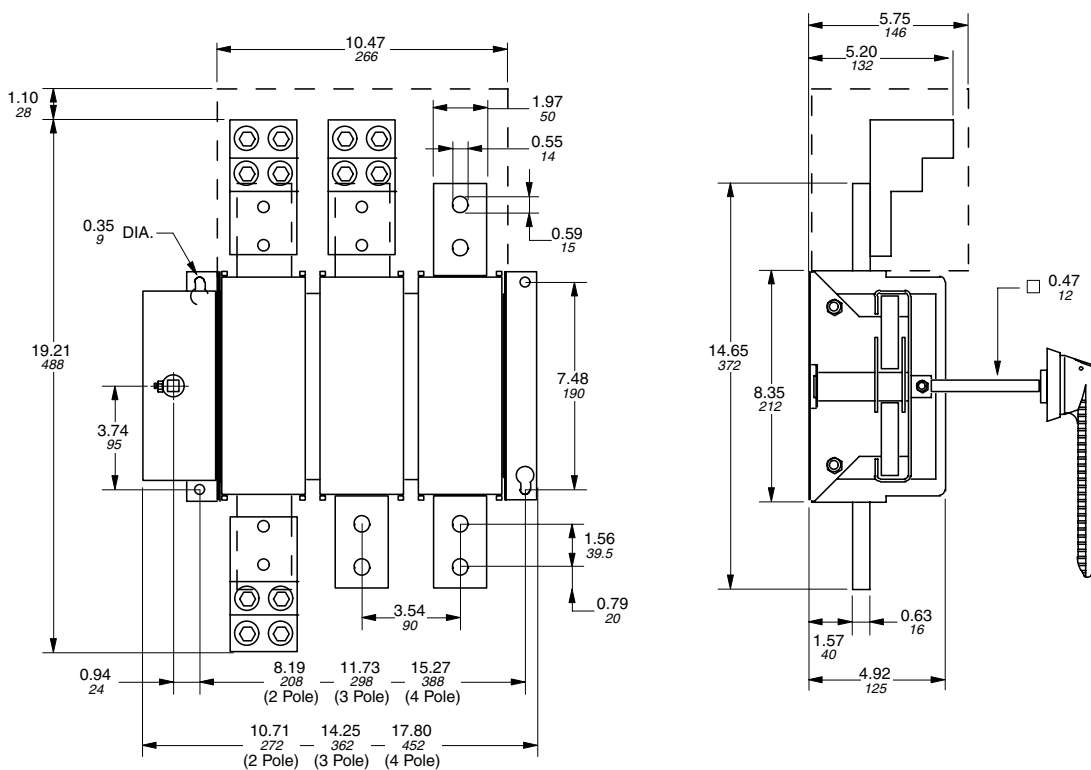

for Non-Fusible Disconnect Switches
BDNF1600 — BDNF3150

BDNF1600

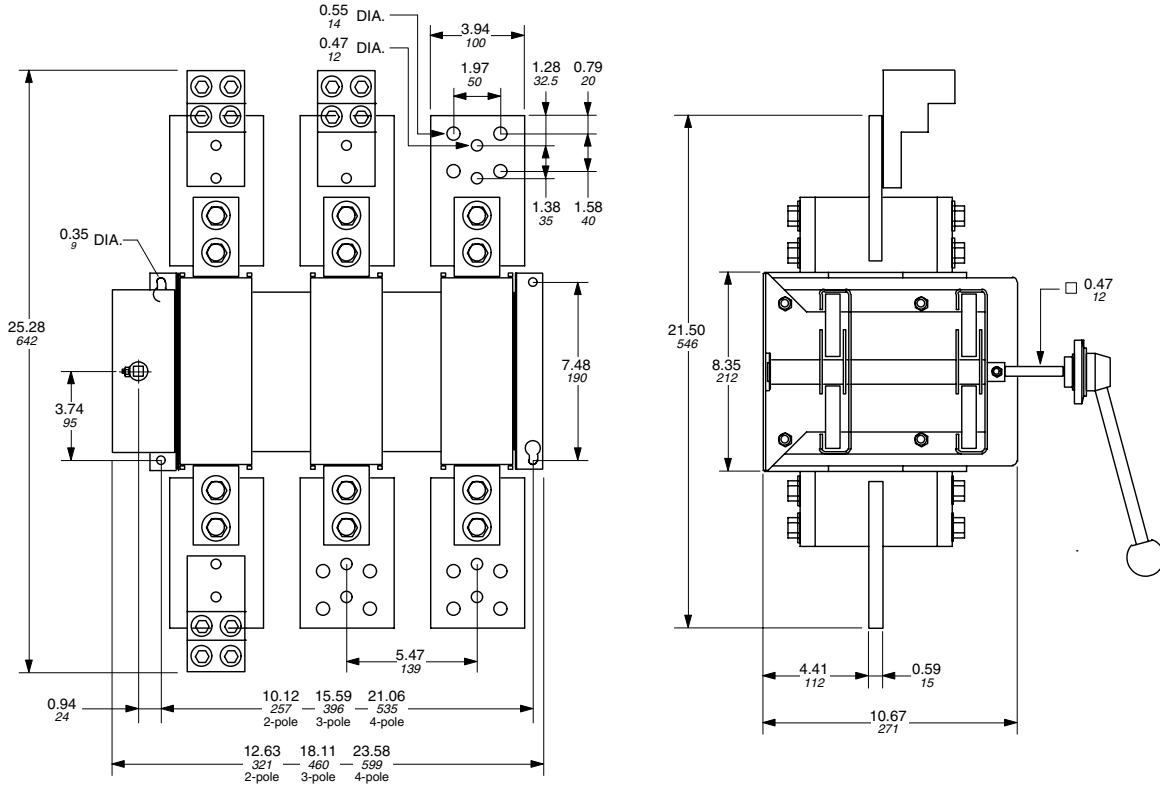

BDNF2000 — BDNF3150

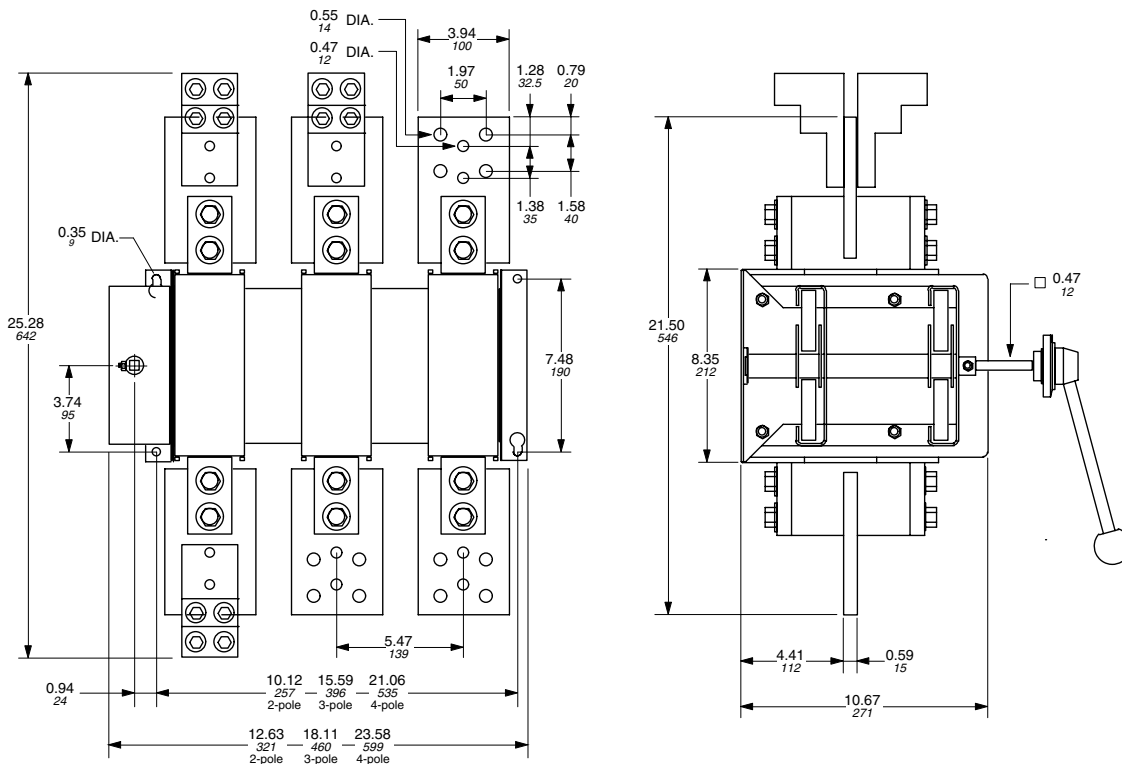

Fusible

Non-Fused

Enclosed Fused

Enclosed Non-Fused

Approximate Dimensions for Terminal Lugs

Bussmann®

BDTL25 — for use with 175A – 200A switches

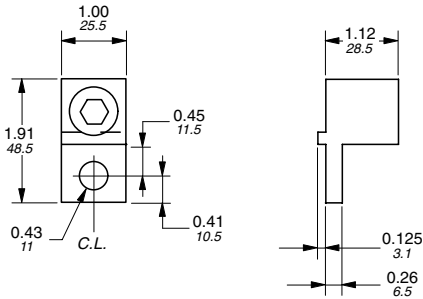

BDTL27 — for use with 600A switches

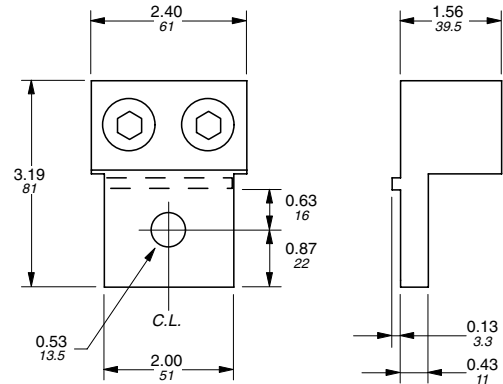

Fusible

Non-Fused

BDTL175 — for use with 175A – 200A switches

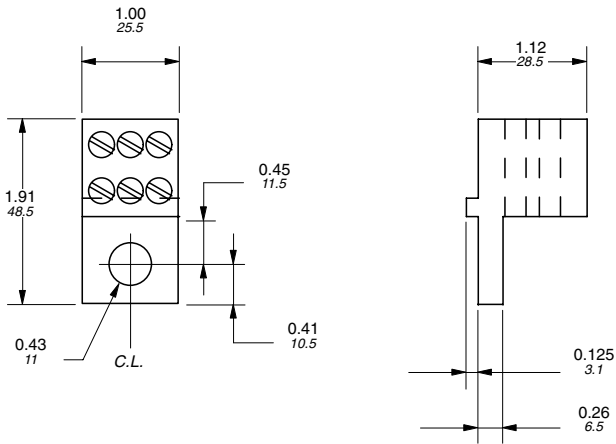

BDTL30 — for use with 800A switches

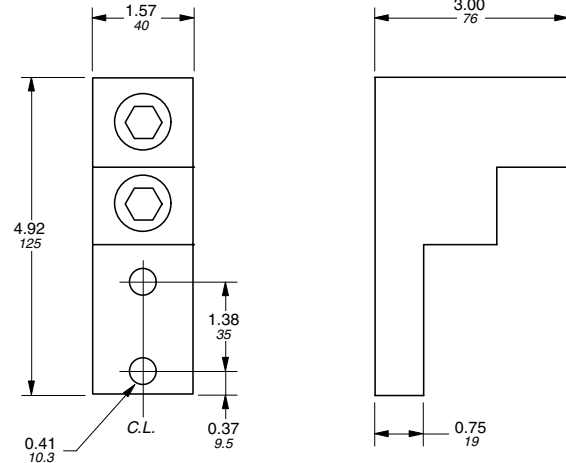

Enclosed Fused

Enclosed Non-Fused

BDTL26 — for use with 400A switches

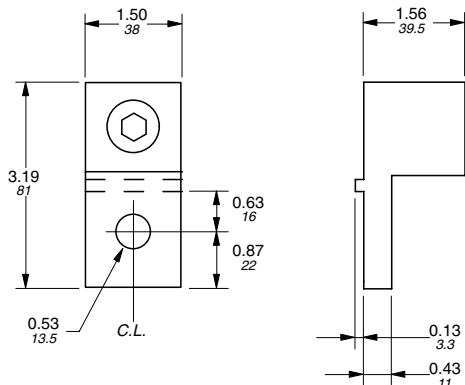

BDTL28 & BDTL28/2 — for use with 1200A – 3150A switches

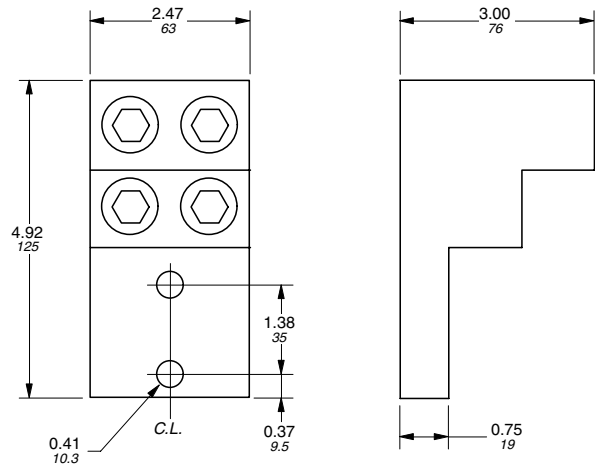

30A – 800A



EFJ30X-3PB6

3 Pole^①, 600V, 30A - 3150A

UL general purpose amp rating	Fuse type	NEMA Enclosure type			
		1	3R	4	4X Stainless
		Catalog number	Catalog number	Catalog number	Catalog number
30	J	EFJ301-3PB6	EFJ303-3PB6	EFJ304-3PB6	EFJ30X-3PB6
30	CC	EFC301-3PB6	EFC303-3PB6	EFC304-3PB6	EFC30X-3PB6
60	J	EFJ601-3PB6	EFJ603-3PB6	EFJ604-3PB8	EFJ60X-3PB8
100	J	EFJ1001-3PB8	EFJ1003-3PB8	EFJ1004-3PB8	EFJ100X-3PB8
200	J ^②	EFJ2001-3PB4	EFJ2003-3PB4	EFJ2004-3PB4	EFJ200X-3PB4
400	J ^②	EFJ4001-3PB4	EFJ4003-3PB4	EFJ4004-3PB4	EFJ400X-3PB4
600	J ^②	EFJ6001-3PB4	EFJ6003-3PB4	EFJ6004-3PB4	EFJ600X-3PB4
800	L	EFL8001-3PB4	EFL8003-3PB4	EFL8004-3PB4	EFL800X-3PB4

Switch ratings

UL general purpose amp rating	Maximum horsepower rating								Wire size for terminal lugs	For wire type	Approval ^①
	Single phase			Three phase							
	120V	200V	240V	200V	208V	240V	480V	600V			
30	2	3	5	5	7.5	7.5	15	20	#18 – 8	Cu	CSA, UL
60	3	7.5	10	15	15	15	30	50	#14 – 4	Cu	CSA, UL
100	5	10	15	25	25	30	60	75	#14 – 2/0	Cu/Al	CSA, UL
200	—	—	—	50	50	60	125	150	#6 – 300 kcmil	Cu/Al	CSA, UL
400	—	—	—	100	125	125	250	350	#2 – 600 kcmil	Cu/Al	CSA, UL
600	—	—	—	150	150	200	400	500	(2) #2 – 600 kcmil	Cu/Al	CSA, UL
800	—	—	—	200	200	250	500	600	(2) #2 – 600 kcmil	Cu/Al	CSA, UL

① Fusible switches are UL listed to the UL98 standard.

② 600V T type fuse clips may be substituted at no charge. Please change the second character of the catalog number from "J" to "T."

30A – 800A



EFJ607-3P

3 Pole^①, 600V, 30A – 3150A

UL general purpose amp rating	Fuse type	NEMA / UL Enclosure type			
		4X Plastic	12	7 & 9	
		Catalog number	Catalog number	Catalog number	
	30	J	EFJ30P-3PB6	EFJ302-3PB6	EFJ307-3PB
	30	CC	EFC30P-3PB6	EFC302-3PB6	EFC307-3PB
	60	J ^②	EFJ60P-3PB8	EFJ602-3PB6	EFJ607-3PB
	100	J ^②	EFJ100P-3PB8	EFJ1002-3PB8	EFJ1007-3PB
	200	J ^②	EFJ200P-3PB4	EFJ2002-3PB4	EFJ2007-3PB
	400	J ^②	EFJ400P-3PB4	EFJ4002-3PB4	EFJ4007-3PB
	600	J ^②	EFJ600P-3PB4	EFJ6002-3PB4	EFJ6007-3PB
800	J ^②	EFL800P-3PB4	EFL8002-3PB4	EFL8007-3PB	

Handle ratings

Amperage range	Style type	NEMA	Color	Marking	Defeatable	Padlockable	Catalog number suffix	Catalog number
30	Selector	1,3R,12	Black	0/I & OFF/ON	Yes	Yes	BJ	CDH5S
	Selector	1,3R,12	Red/Yel	0/I & OFF/ON	Yes	Yes	YJ	CDH6S
	Pistol	1,3R,12	Black	0/I & OFF/ON	Yes	Yes	B6	BDH106
	Pistol	1,3R,12	Red/Yel	0/I & OFF/ON	Yes	Yes	Y6	BDH107
	Pistol	1,3R,4,4X,12	Black	0/I & OFF/ON	Yes	Yes	B6	CDHXB65
	Pistol	1,3R,4,4X,12	Red/Yel	0/I & OFF/ON	Yes	Yes	Y6	CDHXY65
60 – 100	Pistol	1,3R,12	Black	0/I & OFF/ON	Yes	Yes	B6	BDH120
	Pistol	1,3R,12	Red/Yel	0/I & OFF/ON	Yes	Yes	Y6	BDH121
	Pistol	1,3R,12	Black	0/I & OFF/ON	Yes	Yes	B8	BDH58
	Pistol	1,3R,12	Red/Yel	0/I & OFF/ON	Yes	Yes	Y8	BDH59
	Pistol	1,3R,4,4X,12	Black	0/I & OFF/ON	Yes	Yes	B8	CDHXB86
	Pistol	1,3R,4,4X,12	Red/Yel	0/I & OFF/ON	Yes	Yes	Y8	CDHXY86
200 – 800	Pistol	1,3R,12	Black	0/I & OFF/ON	Yes	Yes	B4	BDH114
	Pistol	1,3R,12	Red/Yel	0/I & OFF/ON	Yes	Yes	Y4	BDH115
	Pistol	1,3R,12	Black	0/I & OFF/ON	Yes	Yes	B7	BDH116
	Pistol	1,3R,12	Red/Yel	0/I & OFF/ON	Yes	Yes	Y7	BDH117
	Pistol	1,3R,4,4X,12	Black	0/I & OFF/ON	Yes	Yes	B4	CDHXB12
	Pistol	1,3R,4,4X,12	Red/Yel	0/I & OFF/ON	Yes	Yes	Y4	CDHXY12
	Pistol	1,3R,4,4X,12	Black	0/I & OFF/ON	Yes	Yes	B7	CDHXB22
	Pistol	1,3R,4,4X,12	Red/Yel	0/I & OFF/ON	Yes	Yes	Y7	CDHXY22
Pistol	1,3R,4,4X,12	Metal	0/I & OFF/ON	No	Yes	8	BDH8	

① Fusible switches are UL listed to the UL98 standard.

② 600V T type fuse clips may be substituted at no charge. Please change the second character of the catalog number from "J" to "T."

for Enclosed Fusible Disconnect Switches
30A – 800A

UL general purpose amp rating	Type of Switch	NEMA Enclosure type			
		1 Catalog number	3R Catalog number	4 Catalog number	4X Stainless Catalog number
30 (J fuses)	4 Pole ^①	EFJ301-4PB6	EFJ303-4PB6	EFJ304-4PB6	EFJ30X-4PB6
	6 Pole	EFJ301-6PB6	EFJ303-6PB6	EFJ304-6PB6	EFJ30X-6PB
	Transfer	EFJ301-3TB8	EFJ303-3TB8	EFJ304-3TB8	EFJ30X-3TB8
	Bypass	EFJ301-3BB6	EFJ303-3BB6	EFJ304-3BB6	EFJ30X-3BB6
	Mech. interlock	EFJ301-3MB6	EFJ303-3MB6	EFJ304-3MB6	EFJ30X-3MB6
30 (CC fuses)	4 Pole ^①	EFC301-4PB6	EFC303-4PB6	EFC304-4PB6	EFC30X-4PB6
	6 Pole	EFC301-6PB6	EFC303-6PB6	EFC304-6PB6	EFC30X-6PB6
	Transfer	EFC301-3TB8	EFC303-3TB8	EFC304-3TB8	EFC30X-3TB8
	Bypass	EFC301-3BB6	EFC303-3BB6	EFC304-3BB6	EFC30X-3BB6
	Mech. interlock	EFC301-3MB6	EFC303-3MB6	EFC304-3MB6	EFC30X-3MB6
60	4 Pole ^①	EFJ601-4PB6	EFJ603-4PB6	EFJ604-4PB6	EFJ60X-4PB6
	6 Pole	EFJ601-6PB4	EFJ603-6PB4	EFJ604-6PB4	EFJ60X-6PB4
	Transfer	EFJ601-3TB8	EFJ603-3TB8	EFJ604-3TB8	EFJ60X-3TB8
	Mech. interlock	EFJ601-3MB6	EFJ603-3MB6	EFJ604-3MB6	EFJ60X-3MB6
100	2 Pole ^①	EFJ1001-2PB8	EFJ1003-2PB8	EFJ1004-2PB8	EFJ100X-2PB8
	4 Pole ^①	EFJ1001-4PB8	EFJ1003-4PB8	EFJ1004-4PB8	EFJ100X-4PB8
	6 Pole	EFJ1001-6PB4	EFJ1003-6PB4	EFJ1004-6PB4	EFJ100X-6PB4
	Transfer	EFJ1001-3TB8	EFJ1003-3TB8	EFJ1004-3TB8	EFJ100X-3TB8
	Mech. interlock	EFJ1001-3MB8	EFJ1003-3MB8	EFJ1004-3MB8	EFJ100X-3MB8
200	2 Pole ^①	EFJ2001-2PB8	EFJ2003-2PB8	EFJ2004-2PB8	EFJ200X-2PB8
	4 Pole ^①	EFJ2001-4PB4	EFJ2003-4PB4	EFJ2004-4PB4	EFJ200X-4PB4
	6 Pole	EFJ2001-6P8	EFJ2003-6P8	EFJ2004-6P8	EFJ200X-6P8
	Transfer	EFJ2001-3TB4	EFJ2003-3TB4	EFJ2004-3TB4	EFJ200X-3TB4
	Mech. interlock	EFJ2001-3B6	EFJ2003-3B6	EFJ2004-3B6	EFJ200X-3B6
400	2 Pole ^①	EFJ4001-2PB4	EFJ4003-2PB4	EFJ4004-2PB4	EFJ400X-2PB4
	4 Pole ^①	EFJ4001-4PB4	EFJ4003-4PB4	EFJ4004-4PB4	EFJ400X-4PB4
	6 Pole	EFJ4001-6P8	EFJ4003-6P8	EFJ4004-6P8	EFJ400X-6P8
	Transfer	EFJ4001-3TB4	EFJ4003-3TB4	EFJ4004-3TB4	EFJ400X-3TB4
	Mech. interlock	EFJ4001-3B6	EFJ4003-3B6	EFJ4004-3B6	EFJ400X-3B6
600	2 Pole ^①	EFJ6001-2PB4	EFJ6003-2PB4	EFJ6004-2PB4	EFJ600X-2PB4
	4 Pole ^①	EFJ6001-4PB4	EFJ6003-4PB4	EFJ6004-4PB4	EFJ600X-4PB4
	6 Pole	EFJ6001-6P8	EFJ6003-6P8	EFJ6004-6P8	EFJ600X-6P8
	Transfer	EFJ6001-3TB4	EFJ6003-3TB4	EFJ6004-3TB4	EFJ600X-3TB4
	Mech. interlock	EFJ6001-3B6	EFJ6003-3B6	EFJ6004-3B6	EFJ600X-3B6
800	2 Pole ^①	EFL8001-2PB4	EFL8003-2PB4	EFL8004-2PB4	EFL800X-2PB4
	4 Pole ^①	EFL8001-4PB4	EFL8003-4PB4	EFL8004-4PB4	EFL800X-4PB4
	6 Pole	EFL8001-6P8	EFL8003-6P8	EFL8004-6P8	EFL800X-6P8
	Transfer	EFL8001-3TB4	EFL8003-3TB4	EFL8004-3TB4	EFL800X-3TB4
	Mech. interlock	EFL8001-3B6	EFL8003-3B6	EFL8004-3B6	EFL800X-3B6

2 Pole



4 Pole

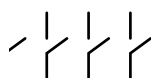

6 Pole

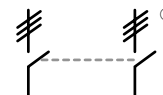

① IEC rated only.
② ≡ = Three poles

Fusible

Non-Fused

Enclosed Fused

Enclosed Non-Fused

for Enclosed Fusible Disconnect Switches
30A - 800A

Fusible

Non-Fused

Enclosed Fused

Enclosed Non-Fused

NEMA Enclosure type

UL General purpose amp rating	Type of Switch	NEMA Enclosure type		
		4X Plastic Catalog number	12 Catalog number	7 & 9 Catalog number
30 (J fuses)	4 Pole ^①	EFJ30P-4PB6	EFJ302-4PB6	②
	6 Pole	EFJ30P-6PB6	EFJ302-6PB6	
	Transfer	EFJ30P-3TB8	EFJ302-3TB8	
	Bypass	EFJ30P-3BB6	EFJ302-3BB6	
	Mech. interlock	EFJ30P-3MB6	EFJ302-3MB6	
30 (CC fuses)	4 Pole ^①	EFC30P-4PB6	EFC302-4PB6	②
	6 Pole	EFC30P-6PB6	EFC302-6PB6	
	Transfer	EFC30P-3TB8	EFC302-3TB8	
	Bypass	EFC30P-3BB6	EFC302-3BB6	
	Mech. interlock	EFC30P-3MB6	EFC302-3MB6	
60	4 Pole ^①	EFJ60P-4PB6	EFJ602-4PB6	②
	6 Pole	EFJ60P-6PB4	EFJ602-6PB4	
	Transfer	EFJ60P-3TB8	EFJ602-3TB8	
	Bypass	EFJ60P-3BB6	EFJ602-3BB6	
	Mech. interlock	EFJ60P-3MB6	EFJ602-3MB6	
100	2 Pole ^①	EFJ100P-2PB8	EFJ1002-2PB8	②
	4 Pole ^①	EFJ100P-4PB8	EFJ1002-4PB8	
	6 Pole	EFJ100P-6PB4	EFJ1002-6PB4	
	Transfer	EFJ100P-3TB8	EFJ1002-3TB8	
	Mech. interlock	EFJ100P-3MB8	EFJ1002-3MB8	
200	2 Pole ^①	EFJ200P-2PB8	EFJ2002-2PB8	②
	4 Pole ^①	EFJ200P-4PB4	EFJ2002-4PB4	
	6 Pole	EFJ200P-6P8	EFJ2002-6P8	
	Transfer	EFJ200P-3TB4	EFJ2002-3TB4	
	Bypass	EFJ200P-3B6	EFJ2002-3B6	
400	2 Pole ^①	EFJ400P-2PB4	EFJ4002-2PB4	②
	4 Pole ^①	EFJ400P-4PB4	EFJ4002-4PB4	
	6 Pole	EFJ400P-6P8	EFJ4002-6P8	
	Transfer	EFJ400P-3TB4	EFJ4002-3TB4	
	Bypass	EFJ400P-3B6	EFJ4002-3B6	
600	2 Pole ^①	EFJ600P-2PB4	EFJ6002-2PB4	②
	4 Pole ^①	EFJ600P-4PB4	EFJ6002-4PB4	
	6 Pole	EFJ600P-6P8	EFJ6002-6P8	
	Transfer	EFJ600P-3TB4	EFJ6002-3TB4	
	Bypass	EFJ600P-3B6	EFJ6002-3B6	
800	2 Pole ^①	EFL800P-2PB4	EFL8002-2PB4	②
	4 Pole ^①	EFL800P-4PB4	EFL8002-4PB4	
	6 Pole	EFL800P-6P8	EFL8002-6P8	
	Transfer	EFL800P-3TB4	EFL8002-3TB4	
	Bypass	EFL800P-3B6	EFL8002-3B6	
800	Mech. interlock	EFL800P-3MB4	EFL8002-3MB4	

Transfer

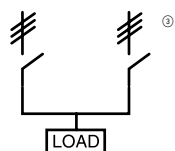

Bypass

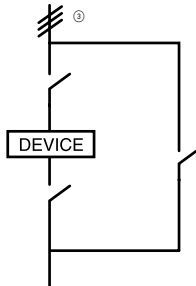

Mechanical interlock

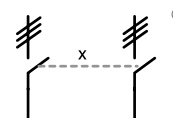

① IEC rated only.
② Consult factory for pricing and availability.
③ = Three poles

for Enclosed Fusible Disconnect Switches

Fusible

Non-Fused

Enclosed Fused

Enclosed Non-Fused



BDAUX157

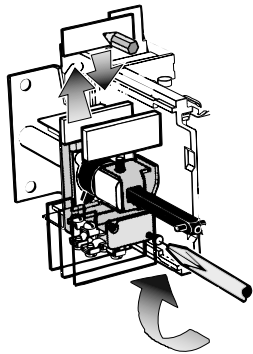

BDAUX7
BDAUX8

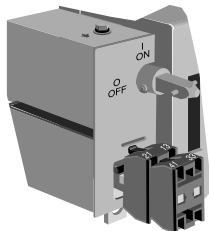

BDAUX1
BDAUX2



3 Position selection switch



Pilot light

Auxiliary contacts

For use on:	Contact configuration	Catalog number	Installation suffix
30A	1 N.O. + 1 N. C. 2 N.O. + 2 N.C.	BDAUX157	add "11" suffix add "22" suffix
60A – 100A	1 N.O. + 1 N.C. 2 N.O. + 2 N.C.	BDAUX7 BDAUX8	add "11" suffix add "22" suffix
200A – 3000A	1 N.O. & 1 N.C. 2 N.O. & 2 N.C.	BDAUX1 BDAUX12	add "11" suffix add "22" suffix

Accessories

For use on:	Description	Installation suffix
30A	Neutral block	N
60A – 100A	Neutral block	N
200A – 400A	Neutral block	N
600A – 800A	Neutral block	N
30A – 200A	Service entrance, 3 wire Service entrance, 4 wire	U V
400A – 800A	Service entrance, 3 wire Service entrance, 4 wire	U V
30A – 3000A	Start/stop pushbuttons 2 position selector switch 3 position selector switch Pilot light "red/run" Ammeter 1 phase Voltmeter	A C D E AM VM

Ground lugs

All enclosed switches are provided with a standard integral ground lug.

Switch size	Ground lug wire size
30	(2) # 14
60	#14 – 1/0
100 – 400	#6 – 250
600 – 800	#2 – 600 mcm

Other Configuration Descriptions for Enclosed Disconnect Switches

Conversion mechanisms

6 or 8 pole

6 (8) pole mechanism allows two switches controlled by one handle to open or close simultaneously.

	POS. O	POS. I
SW. A	O	X
SW. B	O	X

X = Closed
O = Open

Transfer^①

Transfer mechanism manually transfers between two power sources using two switches and a center "OFF" position.

	POS. I	POS.O	POS.II
SW. A	X	O	O
SW. B	O	O	X

X = Closed
O = Open

Bypass^①

Bypass mechanism operates three switches: Two switches in series and one changeover switch to allow power bypass.

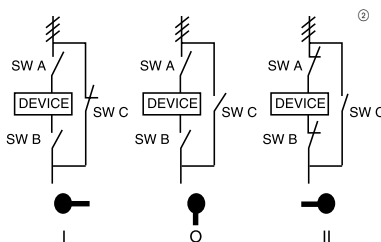

	POS. I	POS.O	POS.II
SW. A	O	O	X
SW. B	O	O	X
SW. C	X	O	O

X = Closed
O = Open

Mechanical interlock

Mechanical interlock mechanism prevents both switches from being in the ON position at the same time.

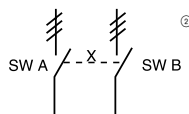

	SW. A POS. I	SW. B POS. O
SW. A	X	O
SW. B	O	X

X = Closed
O = Open

Fusible

Non-Fused

Enclosed Fused

Enclosed Non-Fused

① Transfer and bypass enclosed switches include the load side bussed or cabled together, and all switches come standard with ground lugs.

② = Three poles

for 2, 3 & 4 Pole Enclosed Non-Fusible Switches
16A - 100A

Type 1 — 2, 3 & 4 Pole non-fusible switches

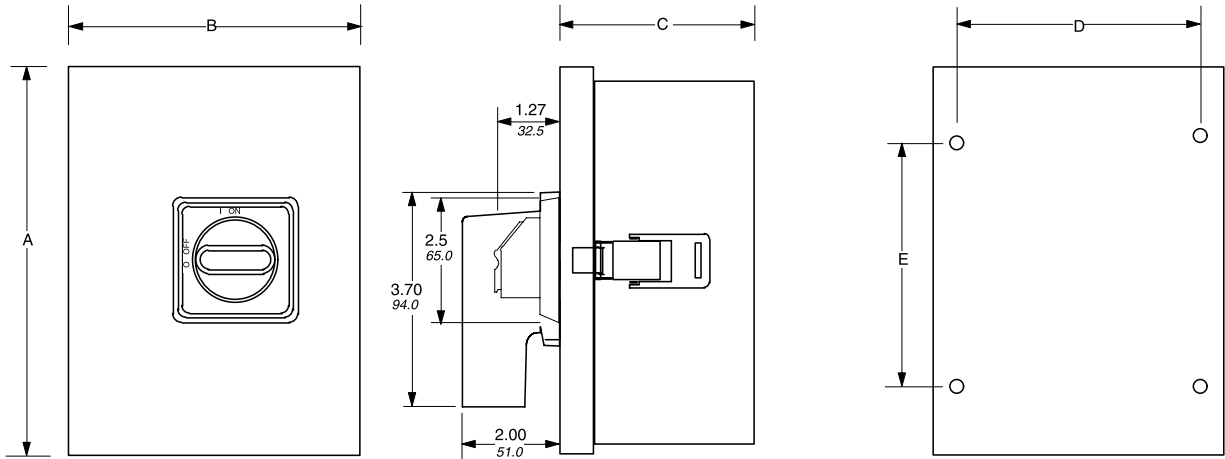

Amps		A	B	C	D	E	Weight 3 pole (lbs)
16A - 40A	in / mm	6.00 / 152.0	6.00 / 152.0	4.00 / 102.0	5.00 / 127.0	3.00 / 76.0	4.10
60A - 80A	in / mm	8.00 / 203.0	6.00 / 152.0	4.00 / 102.0	5.00 / 127.0	5.00 / 127.0	5.60
30, 60, 100A	in / mm	10.00 / 254.0	8.00 / 203.0	6.00 / 152.0	7.00 / 179.0	7.00 / 179.0	9.00

Type 3R, 4, 4X Stainless, 12 — 2, 3 & 4 Pole non-fusible switches

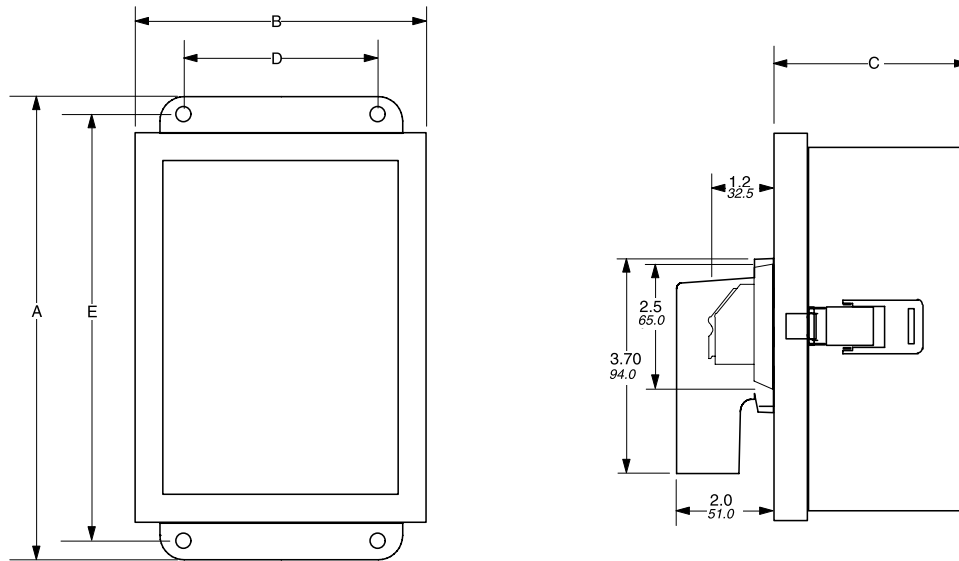

Amps		A	B	C	D	E	Weight 3 pole (lbs)
16A - 40A	in / mm	7.50 / 190.0	6.00 / 152.0	4.00 / 102.0	4.00 / 127.0	6.75 / 171.0	6.50
60A - 80A	in / mm	9.50 / 241.0	6.00 / 152.0	4.00 / 102.0	5.00 / 127.0	8.75 / 222.0	8.30
30, 60, 100A	in / mm	11.50 / 292.0	8.00 / 203.0	6.00 / 152.0	7.00 / 179.0	10.75 / 273.0	12.00

Fusible

Non-Fused

Enclosed Fused

Enclosed Non-Fused

for 2, 3 & 4 Pole Enclosed Non-Fusible & Fusible Switches 16A - 3150A NF; 30A - 800A F

Non-fusible switches

Amp rating	Enclosure type	A Height	B Width	C Depth ^①	D Mounting	E Mounting	Weight (3 Pole)
ENF16,25,32	1	6.0	6.0	4.0	3.0	5.0	4.0
	3R	6.0	6.0	4.0	6.75	4.0	4.0
	4	6.0	6.0	4.0	6.75	4.0	4.0
	4X SS	6.0	6.0	4.0	6.75	4.0	4.0
	4X Plastic	6.0	6.0	5.9	6.75	4.0	4.0
	12	6.0	6.0	4.0	6.75	4.0	4.0
	IP65 (A)	4.8	3.4	2.4	4.17	2.80	1.0
IP65 (B)	5.9	5.1	2.4	5.35	4.57	1.0	
ENF45,63	1	8.0	6.0	4.0	7.0	5.0	6.0
	3R	8.0	6.0	4.0	8.75	4.0	6.0
	4	8.0	6.0	4.0	8.75	4.0	6.0
	4X SS	8.0	6.0	4.0	8.75	4.0	6.0
	4X Plastic	8.0	6.0	5.9	8.75	4.0	6.0
	12	8.0	6.0	4.0	8.75	4.0	6.0
	IP65 (A)	4.8	3.4	2.4	7.24	5.16	1.5
IP65 (B)	5.9	5.1	2.4	14.8	6.93	1.5	
ENF30,60,100	1	10.0	8.0	6.0	7.0	7.0	9.0
	3R	10.0	8.0	6.0	10.75	6.0	9.0
	4	10.0	8.0	6.0	10.75	6.0	9.0
	4X SS	10.0	8.0	6.0	10.75	6.0	9.0
	4X Plastic	10.0	8.0	5.9	10.75	6.0	9.0
	12	10.0	8.0	6.0	10.75	6.0	9.0
	IP65 (A)	7.9	5.7	3.6	7.24	5.16	4.0
IP65 (B)	15.8	7.9	5.5	14.8	6.93	4.0	
125A	1	14.0	12.0	8.0	11.0	9.0	20
	3R	14.0	12.0	8.0	14.75	10.0	20
	4	14.0	12.0	8.0	14.75	10.0	20
	4X SS	14.0	12.0	8.0	14.75	10.0	20
	4X Plastic	14.0	12.0	8.0	14.75	10.0	12
12	14.0	12.0	8.0	14.75	10.0	20	
200	1	24.00	20.00	8.62	15.00	21.88	51.03
	3R	24.00	20.00	8.00	13.00	25.00	62.58
	4	24.00	20.00	8.00	18.50	22.50	54.18
	4X SS	24.00	20.00	8.00	18.50	22.50	55.23
	4X Plastic	24.00	16.00	9.80			33.71
12	24.00	20.00	8.00	18.50	22.50	54.18	
400	1	36.00	30.00	12.62	22.75	33.50	129.89
	3R	36.00	30.00	12.00	28.50	34.50	141.44
	4	36.00	30.00	12.00	28.50	34.50	141.44
	4X SS	36.00	30.00	12.00	28.50	34.50	141.44
	4X Plastic	40.00	20.00	12.00	18.18	42.01	86.31
12	36.00	30.00	12.00	28.50	34.50	141.44	
600	1	36.00	30.00	12.62	22.75	33.50	129.89
	3R	36.00	30.00	12.00	28.50	34.50	141.44
	4	36.00	30.00	12.00	28.50	34.50	141.44
	4X SS	36.00	30.00	12.00	28.50	34.50	141.44
	4X Plastic	40.00	20.00	12.00	18.18	51.85	86.31
12	36.00	30.00	12.00	28.50	34.50	141.44	
800	1	48.00	36.00	13.25	28.75	45.87	237.20
	3R	48.00	36.00	12.00	34.50	46.50	229.85
	4	48.00	36.00	12.00	34.50	46.50	229.85
	4X SS	48.00	36.00	12.00	34.50	46.50	235.10
	4X Plastic	50.00	20.00	12.00	30.00	61.41	124.85
12	48.00	36.00	12.00	34.50	46.50	229.85	
1200	1	48.00	36.00	13.25	28.75	45.87	239.93
	3R	48.00	36.00	12.00	34.50	46.50	232.58
	4	48.00	36.00	12.00	34.50	46.50	232.58
	4X SS	48.00	36.00	12.00	34.50	46.50	237.83
	4X Plastic	50.00	20.00	12.00	30.00	61.41	127.58
12	48.00	36.00	12.00	34.50	46.50	232.58	
1600-3150	Consult factory						

* 3 Pole switches only

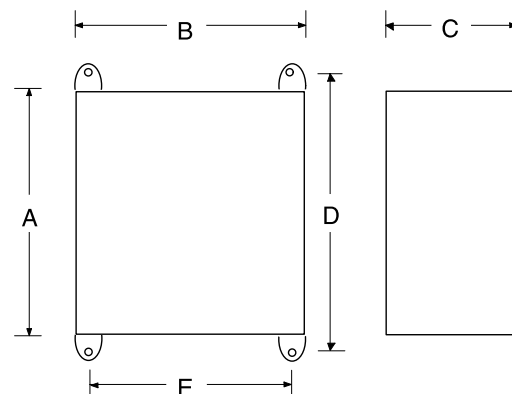

Fusible switches

Amp rating	Enclosure type	A Height	B Width	C Depth ^①	D Mounting	E Mounting	Weight (3 Pole)
30	1	10.00	8.00	6.00	7.00	7.00	11.07
	3R	10.00	8.00	6.00	10.75	6.00	13.17
	4	10.00	8.00	6.00	10.75	6.00	13.17
	4X SS	10.00	8.00	6.00	10.75	6.00	13.17
	4X Plastic	10.00	8.00	7.00	10.75	6.00	8.13
12	10.00	8.00	6.00	10.75	6.00	13.17	
60	1	10.00	8.00	6.00	7.00	7.00	13.15
	3R	10.00	8.00	6.00	10.75	6.00	15.25
	4	10.00	8.00	6.00	10.75	6.00	15.25
	4X SS	10.00	8.00	6.00	10.75	6.00	15.25
	4X Plastic	10.00	8.00	7.00	10.75	6.00	10.21
12	10.00	8.00	6.00	10.75	6.00	15.25	
100	1	14.00	12.00	8.00	11.00	11.00	22.58
	3R	14.00	12.00	8.00			22.58
	4	16.00	12.00	8.00	14.50	10.50	24.57
	4X SS	16.00	12.00	8.00	14.50	10.50	24.57
	4X Plastic	14.00	12.00	7.00	14.94	10.00	15.54
12	14.00	12.00	8.00	14.75	10.00	26.78	
200	1	24.00	24.00 ^②	12.62	21.88	19.00	85.26
	3R ^②	24.00	20.00	12.00	22.50	18.50	69.51
	4	24.00	20.00	12.00	22.50	18.50	69.51
	4X SS	24.00	24.00 ^②	12.00	22.50	22.50	78.96
	4X Plastic	24.00	16.00	9.80	32.16	18.18	42.74
12	24.00	20.00	12.00	22.50	18.50	69.51	
400	1	36.00	30.00	12.62	33.50	22.75	133.56
	3R ^②	36.00	30.00	12.00	34.50	28.50	145.11
	4	36.00	30.00	12.00	34.50	28.50	145.11
	4X SS	36.00	30.00	12.00	34.50	28.50	145.11
	4X Plastic	40.00	20.00	12.00	42.01	28.02	89.99
12	36.00	30.00	12.00	34.50	28.50	145.11	
600	1	48.00	36.00	13.25	45.87	28.75	238.88
	3R ^②	48.00	36.00	12.00	46.50	34.50	231.53
	4	48.00	36.00	12.00	46.50	34.50	231.53
	4X SS	48.00	36.00	12.00	46.50	34.50	236.78
	4X Plastic	50.00	20.00	12.00	51.85	28.02	126.53
12	48.00	36.00	12.00	46.50	34.50	231.53	
800	1	48.00	36.00	17.25	45.87	28.75	255.68
	3R ^②	48.00	36.00	16.00	46.50	34.50	247.28
	4	48.00	36.00	16.00	46.50	34.50	247.28
	4X SS	48.00	36.00	16.00	49.25	30.00	254.63
	4X Plastic	50.00	20.00	12.00	51.85	37.87	126.53
12	48.00	36.00	16.00	46.50	34.50	247.28	

All dimensions are in inches.

① Enclosure depth only. Handle is not included.
② Uses a type 4 enclosure, less cost.

for 6 Pole, Enclosed Transfer & Mechanical Interlock 16A – 3150A NF; 30A – 800A F

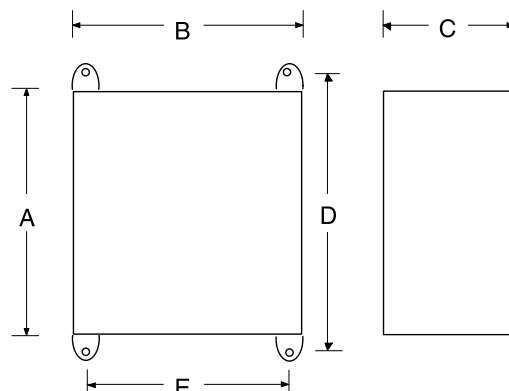

6 Pole, transfer & mechanical interlock non-fusible switches

Amp	Enclosure rating	A type	B Height	C Width	D Depth [Ⓞ]	E Mounting	Weight Mounting
16 – 30	IP65 Plastic	5.91	5.12	3.35	5.35	4.57	3.40
16 – 60	1	10.00	8.00	6.00	7.00	7.00	11.55
	3R	10.00	8.00	6.00	6.00	10.75	13.65
	4	10.00	8.00	6.00	6.00	10.75	13.65
	4X SS	10.00	8.00	6.00	6.00	10.75	13.65
	4X Plastic	10.00	8.00	7.00	6.00	10.75	4.20
12	10.00	8.00	6.00	6.00	10.75	13.65	
80 – 125	1	14.00	12.00	8.00	11.00	11.00	23.63
	3R	14.00	12.00	8.00	8.00	23.63	
	4	16.00	12.00	8.00	10.50	14.50	25.62
	4X SS	16.00	12.00	8.00	10.50	14.50	25.62
	4X Plastic	14.00	12.00	7.00	10.00	14.94	8.93
12	14.00	12.00	8.00	10.00	14.75	27.83	
200	1	30.00	24.00	12.62	22.75	33.50	100.80
	3R	30.00	24.00	12.00	22.50	28.50	93.45
	4	30.00	24.00	12.00	22.50	28.50	93.45
	4X SS	30.00	24.00	12.00	22.50	28.50	93.45
	4X Plastic	30.00	20.00	12.00	18.18	32.16	53.45
12	30.00	24.00	12.00	22.50	28.50	93.45	
400	1	36.00	30.00	12.62	22.75	33.50	144.90
	3R	36.00	30.00	12.00	28.50	34.50	156.45
	4	36.00	30.00	12.00	28.50	34.50	156.45
	4X SS	36.00	30.00	12.00	28.50	34.50	156.45
	4X Plastic	40.00	20.00	12.00	18.18	42.01	101.33
12	36.00	36.00	12.00	28.50	34.50	156.45	
600	1	48.00	36.00	13.25	28.75	45.87	228.90
	3R	48.00	36.00	12.00	34.50	46.50	221.55
	4	48.00	36.00	12.00	34.50	46.50	221.55
	4X SS	48.00	36.00	12.00	34.50	46.50	226.80
	4X Plastic	50.00	20.00	12.00	18.18	51.85	116.55
12	48.00	36.00	12.00	34.50	46.50	221.55	
800	1	60.00	36.00	20.00	30.00	61.25	354.90
	3R	72.00	31.00	24.00	F.S.	F.S.	502.95
	4	72.00	31.00	24.00	F.S.	F.S.	502.95
	4X SS	72.00	31.00	24.00	F.S.	F.S.	502.95
	4X Plastic	72.00	25.00	24.50	F.S.	F.S.	348.60
12	60.00	36.00	20.00	30.00	61.25	354.90	

6 Pole, transfer & mechanical interlock fusible switches

Amp rating	Enclosure type	A Height	B Width	C Depth [Ⓞ]	D Mounting	E Mounting	Weight
30	1	14.00	12.00	8.00	11.00	11.00	22.58
	3R	14.00	12.00	8.00			22.58
	4	16.00	12.00	8.00	10.50	14.50	24.57
	4X SS	16.00	12.00	8.00	10.50	14.50	24.57
	4X Plastic	14.00	12.00	7.00	10.00	14.94	15.54
12	14.00	12.00	8.00	10.00	14.75	26.78	
60	1	24.00	24.00	12.62	19.00	21.88	76.65
	3R	24.00	20.00	12.00	18.50	22.50	60.90
	4	24.00	20.00	12.00	18.50	22.50	60.90
	4X SS	24.00	24.00	12.00	22.50	22.50	70.35
	4X Plastic	24.00	16.00	9.80	18.18	32.16	34.13
12	24.00	20.00	12.00	18.50	22.50	60.90	
100	1	30.00	24.00	12.62	22.75	33.50	94.50
	3R	30.00	24.00	12.00	22.50	28.50	87.15
	4	30.00	24.00	12.00	22.50	28.50	87.15
	4X SS	30.00	24.00	12.00	22.50	28.50	87.15
	4X Plastic	30.00	20.00	12.00	18.18	32.16	47.15
12	30.00	24.00	12.00	22.50	28.50	87.15	
200	1	36.00	30.00	12.62	22.75	33.50	148.05
	3R	36.00	30.00	12.00	28.50	34.50	159.60
	4	36.00	30.00	12.00	28.50	34.50	159.60
	4X SS	36.00	30.00	12.00	28.50	34.50	159.60
	4X Plastic	40.00	20.00	12.00	18.18	42.01	104.48
12	36.00	30.00	12.00	28.50	34.50	159.60	
400	1	36.00	30.00	12.62	22.75	33.50	152.25
	3R	36.00	30.00	12.00	28.50	34.50	163.80
	4	36.00	30.00	12.00	28.50	34.50	163.80
	4X SS	36.00	30.00	12.00	28.50	34.50	163.80
	4X Plastic	40.00	20.00	12.00	18.18	42.01	108.68
12	36.00	30.00	12.00	28.50	34.50	163.80	
600	1	48.00	36.00	17.25	28.75	45.87	295.05
	3R	48.00	36.00	16.00	34.50	46.50	286.65
	4	48.00	36.00	16.00	34.50	46.50	286.65
	4X SS	48.00	36.00	16.00	30.00	49.25	294.00
	4X Plastic	48.25	36.25	16.00	30.00	49.60	222.60
12	48.00	36.00	16.00	34.50	46.50	286.65	
800	1	48.00	36.00	17.25	28.75	45.87	295.05
	3R	48.00	36.00	16.00	34.50	46.50	286.65
	4	48.00	36.00	16.00	34.50	46.50	286.65
	4X SS	48.00	36.00	16.00	30.00	49.25	294.00
	4X Plastic	48.25	36.25	16.00	30.00	49.60	222.60
12	48.00	36.00	16.00	34.50	46.50	286.65	

All dimensions are in inches.

Ⓞ Enclosure depth only. Handle is not included.

for Enclosed Bypass Mechanisms

16A - 3150A NF, 30A - 800A F

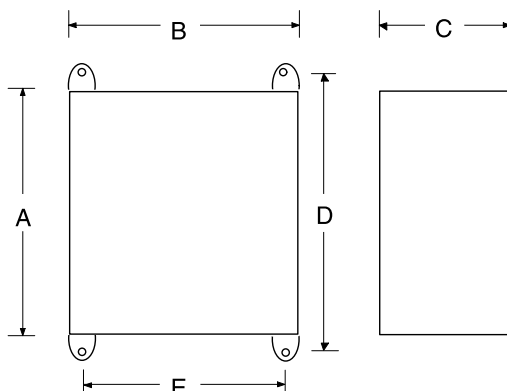

Fusible

Bypass mechanism for non-fusible switches

Amp rating	Enclosure type	A Height	B Width	C Depth ^①	D Mounting	E Mounting	Weight
16 - 60	1	10.00	8.00	6.00	7.00	7.00	11.55
	3R	10.00	8.00	6.00	6.00	10.75	13.65
	4	10.00	8.00	6.00	6.00	10.75	13.65
	4X SS	10.00	8.00	6.00	6.00	10.75	13.65
	4X Plastic	10.00	8.00	7.00			8.61
12	10.00	8.00	6.00	6.00	10.75	13.65	
80 - 125	1	14.00	12.00	8.00	11.00	11.00	23.63
	3R	14.00	12.00	8.00			23.63
	4	16.00	12.00	8.00	10.50	14.50	25.62
	4X SS	16.00	12.00	8.00	10.50	14.50	25.62
	4X Plastic	14.00	12.00	7.00			16.59
12	14.00	12.00	8.00	10.00	14.75	27.83	
200	1	36.00	30.00	12.62	22.75	33.50	144.90
	3R	36.00	30.00	12.00	28.50	34.50	156.45
	4	36.00	30.00	12.00	28.50	34.50	156.45
	4X SS	36.00	30.00	12.00	28.50	34.50	156.45
	4X Plastic	40.00	20.00	12.00			101.33
12	36.00	30.00	12.00	28.50	34.50	156.45	
400	1	36.00	30.00	12.62	22.75	33.50	144.90
	3R	36.00	30.00	12.00	28.50	34.50	156.45
	4	36.00	30.00	12.00	28.50	34.50	156.45
	4X SS	36.00	30.00	12.00	28.50	34.50	156.45
	4X Plastic	40.00	20.00	12.00			101.33
12	36.00	30.00	12.00	28.50	34.50	156.45	
600	1	60.00	36.00	20.00	30.00	61.25	354.90
	3R	72.00	31.00	24.00	F.S.	F.S.	502.95
	4	72.00	31.00	24.00	F.S.	F.S.	502.95
	4X SS	72.00	31.00	24.00	F.S.	F.S.	502.95
	4X Plastic	72.00	25.00	24.50	F.S.	F.S.	348.60
12	60.00	36.00	20.00	30.00	61.25	354.90	
800	1	60.00	36.00	20.00	30.00	61.25	354.90
	3R	72.00	31.00	24.00	F.S.	F.S.	502.95
	4	72.00	31.00	24.00	F.S.	F.S.	502.95
	4X SS	72.00	31.00	24.00	F.S.	F.S.	502.95
	4X Plastic	72.00	25.00	24.50	F.S.	F.S.	347.60
12	60.00	36.00	20.00	30.00	61.25	354.90	

Bypass mechanism for fusible switches

Amp rating	Enclosure type	A Height	B Width	C Depth ^①	D Mounting	E	Weight
30	1	24.00	24.00 ^②	12.62	19.00	21.88	77.70
	3R	24.00	20.00	12.00	18.50	22.50	61.95
	4	24.00	20.00	12.00	18.50	22.50	61.95
	4X SS	24.00	24.00 ^②	12.00	22.50	22.50	71.40
	4X Plastic	24.00	16.00	9.80			35.18
12	24.00	20.00	12.00	18.50	22.50	61.95	
60	1	24.00	24.00 ^②	12.62	19.00	21.88	81.90
	3R ^②	24.00	20.00	12.00	18.50	22.50	66.15
	4	24.00	20.00	12.00	18.50	22.50	66.15
	4X SS	24.00	24.00 ^②	12.00	22.50	22.50	76.50
	4X Plastic	24.00	16.00	9.80			39.38
12	24.00	20.00	12.00	18.50	22.50	66.15	
100	1	30.00	24.00	12.62	22.75	33.50	102.90
	3R ^②	30.00	24.00	12.00	22.50	28.50	95.55
	4	30.00	24.00	12.00	22.50	28.50	95.55
	4X SS	30.00	24.00	12.00	22.50	28.50	95.55
	4X Plastic	30.00	20.00	12.00			55.55
12	30.00	24.00	12.00	22.50	28.50	95.55	
200	1	36.00	30.00	12.62	22.75	33.50	169.05
	3R ^②	36.00	30.00	12.00	28.50	34.50	180.60
	4	36.00	30.00	12.00	28.50	34.50	180.60
	4X SS	36.00	30.00	12.00	28.50	34.50	180.60
	4X Plastic	40.00	20.00	12.00			125.48
12	36.00	30.00	12.00	28.50	34.50	180.60	
400	1	36.00	30.00	12.62	22.75	33.50	173.25
	3R ^②	36.00	30.00	12.00	28.50	34.50	184.80
	4	36.00	30.00	12.00	28.50	34.50	184.80
	4X SS	36.00	30.00	12.00	28.50	34.50	184.80
	4X Plastic	40.00	20.00	12.00			129.68
12	36.00	30.00	12.00	28.50	34.50	184.80	
600	1	48.00	36.00	17.25	28.75	45.87	337.05
	3R ^②	48.00	36.00	16.00	34.50	46.50	328.65
	4	48.00	36.00	16.00	34.50	46.50	328.65
	4X SS	48.00	36.00	16.00	30.00	49.25	336.00
	4X Plastic	48.25	36.25	16.00	30.00	49.60	264.60
12	48.00	36.00	16.00	34.50	46.50	328.65	
800	1	48.00	36.00	17.25	28.75	45.87	337.05
	3R ^②	48.00	36.00	16.00	34.50	46.50	328.65
	4	48.00	36.00	16.00	34.50	46.50	328.65
	4X SS	48.00	36.00	16.00	30.00	49.25	336.00
	4X Plastic	48.25	36.25	16.00	30.00	49.60	264.60
12	48.00	36.00	16.00	34.50	46.50	328.65	

① Enclosure depth only. Handle is not included.
 ② Uses a type 4 enclosure, less cost.

16A – 3150A



ENF321-3PBJ

ENF63X-3PB6

3 Pole, 600V, 16A – 100A — Selector handle

UL general purpose amp rating	NEMA Enclosure type			
	1	3R	4 ^① <small>Selector handles are only NEMA rated 1, 3R, 12</small>	4X Stainless ^① <small>Selector handles are only NEMA rated 1, 3R, 12</small>
	Catalog number	Catalog number	Catalog number	Catalog number
16	ENF161-3PBJ	ENF163-3PBJ	ENF164-3PBJ	ENF16X-3PBJ
25	ENF251-3PBJ	ENF253-3PBJ	ENF254-3PBJ	ENF25X-3PBJ
40	ENF321-3PBJ	ENF323-3PBJ	ENF324-3PBJ	ENF32X-3PBJ
60	ENF451-3PBJ	ENF453-3PBJ	ENF454-3PBJ	ENF45X-3PBJ
80	ENF631-3PBJ	ENF633-3PBJ	ENF634-3PBJ	ENF63X-3PBJ

3 Pole, 600V, 16A – 3150A — Pistol handle

UL general purpose amp rating	NEMA Enclosure type			
	1	3R	4	4X Stainless
	Catalog number	Catalog number	Catalog number	Catalog number
16	ENF161-3PB6	ENF163-3PB6	ENF164-3PB6	ENF16X-3PB6
25	ENF251-3PB6	ENF253-3PB6	ENF254-3PB6	ENF25X-3PB6
40	ENF321-3PB6	ENF323-3PB6	ENF324-3PB6	ENF32X-3PB6
60	ENF451-3PB6	ENF453-3PB6	ENF454-3PB6	ENF45X-3PB6
80	ENF631-3PB6	ENF633-3PB6	ENF634-3PB6	ENF63X-3PB6
30	ENF301-3PB6	ENF303-3PB6	ENF304-3PB6	ENF30X-3PB6
60	ENF601-3PB6	ENF603-3PB6	ENF604-3PB6	ENF60X-3PB6
100	ENF1001-3PB6	ENF1003-3PB6	ENF1004-3PB6	ENF100X-3PB6
125	ENF1251-3PB6	ENF1253-3PB6	ENF1254-3PB6	ENF125X-3PB6
200	ENF2001-3PB8	ENF2003-3PB8	ENF2004-3PB8	ENF200X-3PB8
400	ENF4001-3PB4	ENF4003-3PB4	ENF4004-3PB4	ENF400X-3PB4
600	ENF6001-3PB4	ENF6003-3PB4	ENF6004-3PB4	ENF600X-3PB4
800	ENF8001-3PB4	ENF8003-3PB4	ENF8004-3PB4	ENF800X-3PB4
1200	ENF12001-3PB4	ENF12003-3PB4	ENF12004-3PB4	ENF1200X-3PB4
1600	ENF16001-3P8	ENF16003-3P8	ENF16004-3P8	ENF1600X-3P8
2000	ENF20001-3P8	ENF20003-3P8	ENF20004-3P8	ENF2000X-3P8
3150 ^②	ENF31501-3P8	ENF31503-3P8	ENF31504-3P8	ENF3150X-3P8

① Enclosures are rated as listed, selector handles are only NEMA rated 1, 3R, 12. The overall NEMA rating of an enclosed switch with a selector handle is 1, 3R, 12.
 ② IEC rated only.

Fusible

Non-Fused

Enclosed Fused

Enclosed Non-Fused

16A – 3150A



ENF25P-3PY6



ENF252-3PYJ



ENF16E-3PBJ A



ENF16E-3PBJ B

3 Pole, 600V, 16A – 100A — Selector handle

UL general purpose amp rating	NEMA Enclosure type			IEC Enclosure type
	4X Plastic ^① Selector handles are only NEMA rated 1, 3R, 12	12	7 & 9	IP65 Plastic
	Catalog number	Catalog number	Catalog number	Catalog number
16	ENF16P-3PBJ	ENF162-3PBJ	—	ENF16E-3PBJ A or B
25	ENF25P-3PBJ	ENF252-3PBJ	—	ENF25E-3PBJ
40	ENF32P-3PBJ	ENF322-3PBJ	—	ENF32E-3PBJ
60	ENF45P-3PBJ	ENF452-3PBJ	—	ENF45E-3PBJ
80	ENF63P-3PBJ	ENF632-3PBJ	—	ENF63E-3PBJ

3 Pole, 600V, 16A – 3150A — Pistol handle

UL general purpose amp rating	NEMA Enclosure type			IEC Enclosure type
	4X Plastic	12	7 & 9	IP65 Plastic
	Catalog number	Catalog number	Catalog number	Catalog number
16	ENF16P-3PB6	ENF162-3PB6	ENF167-3P	ENF16E-3PB4
25	ENF25P-3PB6	ENF252-3PB6	ENF257-3P	ENF25E-3PB4
40	ENF32P-3PB6	ENF322-3PB6	ENF327-3P	ENF32E-3PB4
60	ENF45P-3PB6	ENF452-3PB6	ENF457-3P	ENF45E-3PB4
80	ENF63P-3PB6	ENF632-3PB6	ENF637-3P	ENF63E-3PB4
30	ENF30P-3PB6	ENF302-3PB6	ENF307-3P	ENF30E-3PB6
60	ENF60P-3PB6	ENF602-3PB6	ENF607-3P	ENF60E-3PB6
100	ENF100P-3PB6	ENF1002-3PB6	ENF1007-3P	ENF100E-3PB6
125	ENF125P-3PB6	ENF1252-3PB6	ENF1257-3P	ENF125E-3PB6
200	ENF200P-3PB8	ENF2002-3PB8	ENF2007-3P	—
400	ENF400P-3PB4	ENF4002-3PB4	ENF4007-3P	—
600	ENF600P-3PB4	ENF6002-3PB4	ENF6007-3P	—
800	ENF800P-3PB4	ENF8002-3PB4	ENF8007-3P	—
1200	ENF1200P-3PB4	ENF12002-3PB4	ENF12007-3P	—
1600	ENF1600P-3P8	ENF16002-3P8	ENF16007-3P	—
2000	ENF2000P-3P8	ENF20002-3P8	ENF20007-3	—
3150 ^②	ENF3150P-3P8	ENF31502-3P8	ENF31507-3P	—

NOTE: All enclosed switches are provided with a black handle; however, most handles can be substituted with a red and yellow handle if desired. Please substitute the handle suffix code (2nd and 3rd from last characters) with the red/yellow handle catalog number suffix from page 3.12. There is no additional price adder for changing to a red/yellow handle of equal ratings and style.

EXAMPLE: A red/yellow selector handle for an NF161-3PBJA can be substituted for the black selector handle by using the "YJ" suffix instead of the "BJ" suffix, new catalog #NF161-3PYJA.

① Enclosures are rated as listed, selector handles are only NEMA rated 1, 3R, 12. The overall NEMA rating of an enclosed switch with a selector handle is 1, 3R, 12.

② IEC rated only.

16A – 400A
Other Configurations

UL General purpose amp rating	Type of switch	NEMA Enclosure type			
		1	3R	4	4X Stainless
		Catalog number	Catalog number	Catalog number	Catalog number
16	4 Pole	ENF161-4PB6	ENF163-4PB6	ENF164-4PB6	ENF16X-4PB6
	6 Pole	ENF161-6PB6	ENF163-6PB6	ENF164-6PB6	ENF16X-6PB6
	Transfer	ENF161-3TB8	ENF163-3TB8	ENF164-3TB8	ENF16X-3TB8
	Bypass	ENF161-3BB8	ENF163-3BB8	ENF164-3BB8	ENF16X-3BB8
	Mech. interlock	ENF161-3MB6	ENF163-3MB6	ENF164-3MB6	ENF16X-3MB6
25	4 Pole	ENF251-4PB6	ENF253-4PB6	ENF254-4PB6	ENF25X-4PB6
	6 Pole	ENF251-6PB6	ENF253-6PB6	ENF254-6PB6	ENF25X-6PB6
	Transfer	ENF251-3TB8	ENF253-3TB8	ENF254-3TB8	ENF25X-3TB8
	Bypass	ENF251-3BB8	ENF253-3BB8	ENF254-3BB8	ENF25X-3BB8
	Mech. interlock	ENF251-3MB6	ENF253-3MB6	ENF254-3MB6	ENF25X-3MB6
40	4 Pole	ENF321-4PB6	ENF323-4PB6	ENF324-4PB6	ENF32X-4PB6
	6 Pole	ENF321-6PB6	ENF323-6PB6	ENF324-6PB6	ENF32X-6PB6
	Transfer	ENF321-3TB8	ENF323-3TB8	ENF324-3TB8	ENF32X-3TB8
	Bypass	ENF321-3BB8	ENF323-3BB8	ENF324-3BB8	ENF32X-3BB8
	Mech. interlock	ENF321-3MB6	ENF323-3MB6	ENF324-3MB6	ENF32X-3MB6
60	4 Pole	ENF451-4PB6	ENF453-4PB6	ENF454-4PB6	ENF45X-4PB6
	6 Pole	ENF451-6PB6	ENF453-6PB6	ENF454-6PB6	ENF45X-6PB6
	Transfer	ENF451-3TB8	ENF453-3TB8	ENF454-3TB8	ENF45X-3TB8
	Bypass	ENF451-3BB8	ENF453-3BB8	ENF454-3BB8	ENF45X-3BB8
	Mech. interlock	ENF451-3MB6	ENF453-3MB6	ENF454-3MB6	ENF45X-3MB6
80	4 Pole	ENF631-4PB6	ENF633-4PB6	ENF634-4PB6	ENF63X-4PB6
	6 Pole	ENF631-6PB6	ENF633-6PB6	ENF634-6PB6	ENF63X-6PB6
	Transfer	ENF631-3TB8	ENF633-3TB8	ENF634-3TB8	ENF63X-3TB8
	Bypass	ENF631-3BB8	ENF633-3BB8	ENF634-3BB8	ENF63X-3BB8
	Mech. interlock	ENF631-3MB6	ENF633-3MB6	ENF634-3MB6	ENF63X-3MB6
30	4 Pole	ENF301-4PB6	ENF303-4PB6	ENF304-4PB6	ENF30X-4PB6
	6 Pole	ENF301-6PB6	ENF303-6PB6	ENF304-6PB6	ENF30X-6PB6
	Transfer	ENF301-3TB8	ENF303-3TB8	ENF304-3TB8	ENF30X-3TB8
	Bypass	ENF301-3BB8	ENF303-3BB8	ENF304-3BB8	ENF30X-3BB8
	Mech. interlock	ENF301-3MB6	ENF303-3MB6	ENF304-3MB6	ENF30X-3MB6
60	4 Pole	ENF601-4PB6	ENF603-4PB6	ENF604-4PB6	ENF60X-4PB6
	6 Pole	ENF601-6PB6	ENF603-6PB6	ENF604-6PB6	ENF60X-6PB6
	Transfer	ENF601-3TB8	ENF603-3TB8	ENF604-3TB8	ENF60X-3TB8
	Bypass	ENF601-3BB8	ENF603-3BB8	ENF604-3BB8	ENF60X-3BB8
	Mech. interlock	ENF601-3MB6	ENF603-3MB6	ENF604-3MB6	ENF60X-3MB6
100	4 Pole	ENF1001-4PB6	ENF1003-4PB6	ENF1004-4PB6	ENF100X-4PB6
	6 Pole	ENF1001-6PB6	ENF1003-6PB6	ENF1004-6PB6	ENF100X-6PB6
	Transfer	ENF1001-3TB8	ENF1003-3TB8	ENF1004-3TB8	ENF100X-3TB8
	Bypass	ENF1001-3BB8	ENF1003-3BB8	ENF1004-3BB8	ENF100X-3BB8
	Mech. interlock	ENF1001-3MB6	ENF1003-3MB6	ENF1004-3MB6	ENF100X-3MB6
125	2 Pole	ENF1251-2PB6	ENF1253-2PB6	ENF1254-2PB6	ENF125X-2PB6
	4 Pole	ENF1251-4PB6	ENF1253-4PB6	ENF1254-4PB6	ENF125X-4PB6
	6 Pole	ENF1251-6PB2	ENF1253-6PB2	ENF1254-6PB4	ENF125X-6PB4
	Transfer	ENF1251-3TB8	ENF1253-3TB8	ENF1254-3TB8	ENF125X-3TB8
	Mech. interlock	ENF1251-3MB6	ENF1253-3MB6	ENF1254-3MB8	ENF125X-3MB8
200	2 Pole	ENF2001-2PB8	ENF2003-2PB8	ENF2004-2PB8	ENF200X-2PB8
	4 Pole	ENF2001-4PB8	ENF2003-4PB8	ENF2004-4PB8	ENF200X-4PB8
	6 Pole	ENF2001-6PB4	ENF2003-6PB4	ENF2004-6PB4	ENF200X-6PB4
	Transfer	ENF2001-3TB4	ENF2003-3TB4	ENF2004-3TB4	ENF200X-3TB4
	Mech. interlock	ENF2001-3BB4	ENF2003-3BB4	ENF2004-3BB4	ENF200X-3BB4
400	2 Pole	ENF4001-2PB4	ENF4003-2PB4	ENF4004-2PB4	ENF400X-2PB4
	4 Pole	ENF4001-4PB4	ENF4003-4PB4	ENF4004-4PB4	ENF400X-4PB4
	6 Pole	ENF4001-6P8	ENF4003-6P8	ENF4004-6P8	ENF400X-6P8
	Transfer	ENF4001-3TB4	ENF4003-3TB4	ENF4004-3TB4	ENF400X-3TB4
	Mech. interlock	ENF4001-3B6	ENF4003-3B6	ENF4004-3B6	ENF400X-3B6
		ENF4001-3MB4	ENF4003-3MB4	ENF4004-3MB4	ENF400X-3MB4

Fusible

Non-Fused

Enclosed Fused

Enclosed Non-Fused

16A – 400A Other Configurations

UL General purpose amp rating	Type of switch	NEMA Enclosure type			IEC Enclosure type
		4X Plastic	12	7 & 9	IP65
		Catalog number	Catalog number	Catalog number	Catalog number
16	4 pole	ENF16P-4PB6	ENF162-4PB6	ENF167-4P	ENF16E-4PBJ
	6 pole	ENF16P-6PB6	ENF162-6PB6	ENF167-6P	ENF16E-6PBJ
	Transfer	ENF16P-3TB8	ENF162-3TB8	ENF167-3T	—
	Bypass	ENF16P-3BB8	ENF162-3BB8	ENF167-3B	—
	Mech. interlock	ENF16P-3MB6	ENF162-3MB6	—	—
25	4 pole	ENF25P-4PB6	ENF252-4PB6	ENF257-4P	ENF25E-4PBJ
	6 pole	ENF25P-6PB6	ENF252-6PB6	ENF257-6P	ENF25E-6PBJ
	Transfer	ENF25P-3TB8	ENF252-3TB8	ENF257-3T	—
	Bypass	ENF25P-3BB8	ENF252-3BB8	ENF257-3B	—
	Mech. interlock	ENF25P-3MB6	ENF252-3MB6	—	—
40	4 Pole	ENF32P-4PB6	ENF322-4PB6	ENF327-4P	ENF32E-4PBJ
	6 Pole	ENF32P-6PB6	ENF322-6PB6	ENF327-6P	ENF32E-6PBJ
	Transfer	ENF32P-3TB8	ENF322-3TB8	ENF327-3T	—
	Bypass	ENF32P-3BB8	ENF323-3BB8	ENF327-3B	—
	Mech. interlock	ENF32P-3MB6	ENF322-3MB6	—	—
60	4 Pole	ENF45P-4PB6	ENF452-4PB6	ENF457-4P	ENF45E-4PBJ
	6 Pole	ENF45P-6PB6	ENF452-6PB6	ENF457-6P	ENF45E-6PBJ
	Transfer	ENF45P-3TB8	ENF452-3TB8	ENF457-3T	—
	Bypass	ENF45P-3BB8	ENF452-3BB8	ENF457-3B	—
	Mech. interlock	ENF45P-3MB6	ENF452-3MB6	—	—
80	4 Pole	ENF63P-4PB6	ENF632-4PB6	ENF637-4P	ENF63E-4PBJ
	6 Pole	ENF63P-6PB6	ENF632-6PB6	ENF637-6P	ENF63E-6PBJ
	Transfer	ENF63P-3TB8	ENF632-3TB8	ENF637-3T	—
	Bypass	ENF63P-3BB8	ENF632-3BB8	ENF637-3B	—
	Mech. interlock	ENF63P-3MB6	ENF632-3MB6	—	—
30	4 Pole	ENF30P-4PB6	ENF302-4PB6	ENF307-4P	ENF30E-4PB4
	6 Pole	ENF30P-6PB6	ENF302-6PB6	ENF307-6P	ENF30E-6PB6
	Transfer	ENF30P-3TB8	ENF302-3TB8	ENF307-3T	—
	Bypass	ENF30P-3BB8	ENF302-3BB8	ENF307-3B	—
	Mech. interlock	ENF30P-3MB6	ENF302-3MB6	—	—
60	4 Pole	ENF60P-4PB6	ENF602-4PB6	ENF607-4P	ENF60E-4PB4
	6 Pole	ENF60P-6PB6	ENF602-6PB6	ENF607-6P	ENF60E-6PB6
	Transfer	ENF60P-3TB8	ENF602-3TB8	ENF607-3T	—
	Bypass	ENF60P-3BB8	ENF602-3BB8	ENF607-3B	—
	Mech. interlock	ENF60P-3MB6	ENF602-3MB6	—	—
100	4 Pole	ENF100P-4PB6	ENF1002-4PB6	ENF1007-4P	ENF100E-4PB4
	6 Pole	ENF100P-6PB6	ENF1002-6PB6	ENF1007-6P	ENF100E-6PB6
	Transfer	ENF100P-3TB8	ENF1002-3TB8	ENF1007-3T	—
	Bypass	ENF100P-3BB8	ENF1002-3BB8	ENF1007-3B	—
	Mech. interlock	ENF100P-3MB6	ENF1002-3MB6	—	—
125	2 Pole	ENF125P-2PB6	ENF1252-2PB6	ENF1257-2P	—
	4 Pole	ENF125P-4PB6	ENF1252-4PB6	ENF1257-4P	—
	6 Pole	ENF125P-6PB2	ENF1252-6PB2	ENF1257-6P	—
	Transfer	ENF125P-3TB8	ENF1252-3TB8	ENF1257-3T	—
	Mech. interlock	ENF125P-3MB6	ENF1252-3MB6	—	—
200	2 Pole	ENF200P-2PB8	ENF2002-2PB8	ENF2007-2P	—
	4 Pole	ENF200P-4PB8	ENF2002-4PB8	ENF2007-4P	—
	6 Pole	ENF200P-6PB4	ENF2002-6PB4	ENF2007-6P	—
	Transfer	ENF200P-3TB4	ENF2002-3TB4	ENF2007-3T	—
	Mech. interlock	ENF200P-3MB8	ENF2002-3MB8	ENF2007-3B	—
400	2 Pole	ENF400P-2PB4	ENF4002-2PB4	ENF4007-2P	—
	4 Pole	ENF400P-4PB4	ENF4002-4PB4	ENF4007-4P	—
	6 Pole	ENF400P-6P8	ENF4002-6P8	ENF4007-6P	—
	Transfer	ENF400P-3TB4	ENF4002-3TB4	ENF4007-3T	—
	Mech. interlock	ENF400P-3MB4	ENF4002-3MB4	—	—

600A – 3150A Other Configurations

UL General purpose amp rating	Type of switch	NEMA Enclosure type			
		1	3R	4	4X Stainless
		Catalog number	Catalog number	Catalog number	Catalog number
600	2 Pole	ENF6001-2PB4	ENF6003-2PB4	ENF6004-2PB4	ENF600X-2PB4
	4 Pole	ENF6001-4PB4	ENF6003-4PB4	ENF6004-4PB4	ENF600X-4PB4
	6 Pole	ENF6001-6P8	ENF6003-6P8	ENF6004-6P8	ENF600X-6P8
	Transfer	ENF6001-3TB4	ENF6003-3TB4	ENF6004-3TB4	ENF600X-3TB4
	Bypass	ENF6001-3B6	ENF6003-3B6	ENF6004-3B6	ENF600X-3B6
	Mech. interlock	ENF6001-3MB4	ENF6003-3MB4	ENF6004-3MB4	ENF600X-3MB4
800	2 Pole	ENF8001-2PB4	ENF8003-2PB4	ENF8004-2PB4	ENF800X-2PB4
	4 Pole	ENF8001-4PB4	ENF8003-4PB4	ENF8004-4PB4	ENF800X-4PB4
	6 Pole	ENF8001-6P8	ENF8003-6P8	ENF8004-6P8	ENF800X-6P8
	ransfer	ENF8001-3TB4	ENF8003-3TB4	ENF8004-3TB4	ENF800X-3TB4
	Bypass	ENF8001-3B6	ENF8003-3B6	ENF8004-3B6	ENF800X-3B6
	Mech. interlock	ENF8001-3MB4	ENF8003-3MB4	ENF8004-3MB4	ENF800X-3MB4
1200	2 Pole	ENF12001-2PB4	ENF12003-2PB4	ENF12004-2PB4	ENF1200X-2PB4
	4 Pole	ENF12001-4PB4	ENF12003-4PB4	ENF12004-4PB4	ENF1200X-4PB4
	6 Pole	ENF12001-6P8	ENF12003-6P8	ENF12004-6P8	ENF12001-6P8
	Transfer	ENF12001-3TB4	ENF12003-3TB4	ENF12004-3TB4	ENF1200X-3TB4
	Bypass	ENF12001-3B6	ENF12003-3B6	ENF12004-3B6	ENF1200X-3B6
	Mech. interlock	ENF12001-3MB4	ENF12003-3MB4	ENF12004-3MB4	ENF1200X-3MB4
1600	2 Pole	ENF16001-2P8	ENF16003-2P8	ENF16004-2P8	ENF1600X-2P8
	4 Pole	ENF16001-4P8	ENF16003-4P8	ENF16004-4P8	ENF1600X-4P8
	6 Pole	—	—	—	—
	Transfer	—	—	—	—
	Bypass	—	—	—	—
	Mech. interlock	—	—	—	—
2000	2 Pole	ENF20001-2P8	ENF20003-2P8	ENF20004-2P8	ENF2000X-2P8
	4 Pole	ENF20001-4P8	ENF20003-4P8	ENF20004-4P8	ENF2000X-4P8
	6 Pole	—	—	—	—
	Transfer	—	—	—	—
	Bypass	—	—	—	—
	Mech. interlock	—	—	—	—
3150	2 Pole	ENF31501-2P8	ENF31503-2P8	ENF31504-2P8	ENF3150X-2P8
	4 Pole	ENF31501-4P8	ENF31503-4P8	ENF31504-4P8	ENF3150X-4P8
	6 Pole	—	—	—	—
	Transfer	—	—	—	—
	Bypass	—	—	—	—
	Mech. interlock	—	—	—	—

Fusible

Non-Fused

Enclosed Fused

Enclosed Non-Fused

① IEC rated only.

600A – 3150A Other Configurations

UL General purpose amp rating	Type of switch	NEMA Enclosure type		
		4X Plastic	12	7 & 9
		Catalog number	Catalog number	Catalog number
600	2 pole	ENF600P-2PB4	ENF6002-2PB4	ENF6007-2P
	4 pole	ENF600P-4PB4	ENF6002-4PB4	ENF6007-4P
	6 pole	ENF600P-6P8	ENF6002-6P8	ENF6007-6P
	Transfer	ENF600P-3TB4	ENF6002-3TB4	ENF6007-3T
	Bypass	ENF600P-3B6	ENF6002-3B6	ENF6007-3B
	Mech. interlock	ENF600P-3MB4	ENF6002-3MB4	—
	800	2 pole	ENF800P-2PB4	ENF8002-2PB4
4 pole ^①		ENF800P-4PB4	ENF8002-4PB4	ENF8007-4P
6 pole		ENF800P-6P8	ENF8002-6P8	ENF8007-6P
Transfer		ENF800P-3TB4	ENF8002-3TB4	ENF8007-3T
Bypass		ENF800P-3B6	ENF8002-3B6	ENF8007-3B
Mech. interlock		ENF800P-3MB4	ENF8002-3MB4	—
1200		2 pole	ENF1200P-2PB4	ENF12002-2PB4
	4 pole ^①	ENF1200P-4PB4	ENF12002-4PB4	ENF12007-4P
	6 pole	ENF1200P-6P8	ENF12002-6P8	ENF12007-6P
	Transfer	ENF1200P-3TB4	ENF12002-3TB4	ENF12007-3T
	Bypass	ENF1200P-3B6	ENF12002-3B6	ENF12007-3B
	Mech. interlock	ENF1200P-3MB4	ENF12002-3MB4	—
	1600	2 pole	ENF1600P-2P8	ENF16002-2P8
4 pole ^①		ENF1600P-4P8	ENF16002-4P8	②
2000	2 pole	ENF2000P-2P8	ENF20002-2P8	②
	4 pole ^①	ENF2000P-4P8	ENF20002-4P8	②
3150 ^①	2 pole ^①	ENF3150P-2P8	ENF31502-2P8	②
	4 pole ^①	ENF3150P-4P8	ENF31502-4P8	②

① IEC rated only.

② Consult factory for price and availability.

for Enclosed Non-Fusible Disconnect Switches

Fusible

Non-Fused

Enclosed Fused

Enclosed Non-Fused



CDAUX_ _

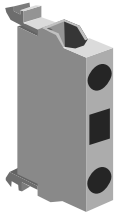

CDAUXCA_ _

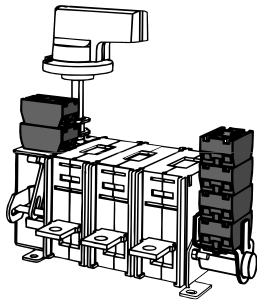

BDAUX_ _



3 Position selector switch



Pilot light

Auxiliary contacts

For use on:	Contact configuration	Catalog number	Installation suffix
16A – 100A	1 N.O.	CDAUX10	add "10" suffix
	1 N.C.	CDAUX01	add "01" suffix
125A	1 N.O.	CDAUXCA10	add "10" suffix
	1 N.C.	CDAUXCA01	add "01" suffix
200A	1 N.O. & 1 N.C.	BDAUX12	add "11" suffix
	2 N.O. & 2 N.C.	BDAUX13	add "22" suffix
400A – 3150A	1 N.O. & 1 N.C.	BDAUX1	add "11" suffix
	2 N.O. & 2 N.C.	BDAUX2	add "22" suffix

Accessories

For use on:	Contact configuration		Installation suffix
16, 25, 40A	Neutral or isolated ground block		N or G
40A – 60A	Neutral or isolated ground block		N or G
80A – 100A	Neutral or isolated ground block		N or G
125A	Neutral or isolated ground block		N or G
200A – 1200A	Neutral block		N
1600A – 3150A	Neutral block		N
16A – 30A	Switched neutral block		S
40A – 60A	Switched neutral block		S
80A – 100A	Switched neutral block		S
125A	Switched neutral block		S
80A – 1200A	Service entrance, 3 wire		U
80A – 1200A	Service entrance, 4 wire		V
16A – 3150A	Start/stop pushbuttons		A
	2 position selector switch		C
	3 position selector switch		D
	Pilot light "red/run"		E
	Ammeter 1 phase		AM
	Voltmeter		VM

Ground lugs

All enclosed switches are provided with a standard integral ground lug.

Switch size	Ground lug Wire size
16A – 100A	(2) #14
200A – 400A	#6 – 250 mcm
600A – 1200A	#2 – 600 mcm
2000A – 3150A	(2) #2 – 600 mcm

for Enclosed Non-Fusible Disconnect Switches

Switch ratings, 16 – 3150 Amps, 600V

UL General purpose amp rating	Maximum horsepower rating							Wire size for terminal lugs	For wire type	Approval	
	Single phase			Three phase							
	120V	200V	240V	200V – 208V	240V	480V	600V				
UL 508	16	1/2	1.5	1.5	3	5	10	10	#18 – 8	Cu	CSA, UL ^①
	25	3/4	2	2	7.5	7.5	15	20	#18 – 8	Cu	CSA, UL ^①
	40	1	3	3	10	10	20	25	#18 – 8	Cu	CSA, UL ^①
	60	2	5	5	15	15	30	30	#14 – 1	Cu	CSA, UL ^①
	80	2	5	5	20	20	40	50	#14 – 1	Cu	CSA, UL ^①
	UL 98	30	2	5	5	10	10	20	30	#14 – 4	Cu
60		3	7.5	7.5	20	20	40	40	#14 – 4	Cu	CSA, UL ^②
100		5	15	15	25	25	50	40	#8 – 1/0	Cu	CSA, UL ^②
125		7.5	20	20	30	30	60	75	#8 – 1/0	Cu	CSA, UL ^②
200		—	—	—	60	75	150	200	#6 – 300 kcmil	Cu	CSA, UL ^②
400		—	—	—	100	125	250	350	#2 – 600 kcmil	Cu	CSA, UL ^②
600		—	—	—	150	200	400	500	(2) #2 – 600 kcmil	Cu	CSA, UL ^②
800		—	—	—	200	250	500	600	(2) #2 – 600 kcmil	Cu/Al	CSA, UL ^②
1200		—	—	—	—	—	—	—	(4) #2 – 600 kcmil	Cu/Al	CSA, UL ^②
1600		—	—	—	—	—	—	—	(4) #2 – 600 kcmil	Cu/Al	CSA, UL ^②
2000		—	—	—	—	—	—	—	(8) #2 – 600 kcmil	Cu/Al	CSA, UL ^②
3150 ^③		—	—	—	—	—	—	—	(8) #2 – 600 kcmil	Cu/Al	IEC

Handle ratings, 16 – 3150 Amps, 600V

Amperage range	Style type	NEMA	Color	Marking	Defeatable	Padlockable	Catalog number suffix	Catalog number
16 – 100	Selector	1,3R,12	Black	0/I & OFF/ON	Yes	Yes	BJ	CDH5S
	Selector	1,3R,12	Red/Yel	0/I & OFF/ON	Yes	Yes	YJ	CDH6S
	Pistol	1,3R,12	Black	0/I & OFF/ON	Yes	Yes	B6	BDH106
	Pistol	1,3R,12	Red/Yel	0/I & OFF/ON	Yes	Yes	Y6	BDH107
	Pistol	1,3R,4,4X,12	Black	0/I & OFF/ON	Yes	Yes	B6	CDHXB65
	Pistol	1,3R,4,4X,12	Red/Yel	0/I & OFF/ON	Yes	Yes	Y6	CDHXY65
125	Pistol	1,3R,12	Black	0/I & OFF/ON	Yes	Yes	B6	BDH120
	Pistol	1,3R,12	Red/Yel	0/I & OFF/ON	Yes	Yes	Y6	BDH121
	Pistol	1,3R,4,4X,12	Black	0/I & OFF/ON	Yes	Yes	B8	CDHXB86
	Pistol	1,3R,4,4X,12	Red/Yel	0/I & OFF/ON	Yes	Yes	Y8	CDHXY86
200	Pistol	1,3R,12	Black	0/I & OFF/ON	Yes	Yes	B8	BDH110
	Pistol	1,3R,12	Red/Yel	0/I & OFF/ON	Yes	Yes	Y8	BDH111
	Pistol	1,3R,4,4X,12	Black	0/I & OFF/ON	Yes	Yes	B8	CDHXB88
	Pistol	1,3R,4,4X,12	Red/Yel	0/I & OFF/ON	Yes	Yes	Y8	CDHXY88
400 – 3150	Pistol	1,3R,12	Black	0/I & OFF/ON	Yes	Yes	B4	BDH114
	Pistol	1,3R,12	Red/Yel	0/I & OFF/ON	Yes	Yes	Y4	BDH115
	Pistol	1,3R,12	Black	0/I & OFF/ON	Yes	Yes	B7	BDH116
	Pistol	1,3R,12	Red/Yel	0/I & OFF/ON	Yes	Yes	Y7	BDH117
	Pistol	1,3R,4,4X,12	Black	0/I & OFF/ON	Yes	Yes	B4	CDHXB12
	Pistol	1,3R,4,4X,12	Red/Yel	0/I & OFF/ON	Yes	Yes	Y4	CDHXY12
	Pistol	1,3R,4,4X,12	Black	0/I & OFF/ON	Yes	Yes	B7	CDHXB22
	Pistol	1,3R,4,4X,12	Red/Yel	0/I & OFF/ON	Yes	Yes	Y7	CDHXY22
	Pistol	1,3R,4,4X,12	Metal	0/I & OFF/ON	No	Yes	8	BDH8

① UL listed (UL508).
 ② UL listed (UL98).
 ③ IEC rated only.

Introduction

An enclosure is a surrounding case constructed to provide a degree of protection to personnel against accidental contact with the enclosed equipment and to provide a degree of protection to the enclosed equipment against specified environmental conditions.

A brief description of the more common types of enclosures used by the electrical industry relating to their environmental capabilities follows. Refer to

NEMA Standards Publication for more information regarding applications, features and design tests.

Individual NEMA product Standards Publications or third party certification standards may contain additional requirements for product testing and performance.

Definitions pertaining to nonhazardous locations



Type 1

Enclosures are intended for indoor use primarily to provide a degree of protection against limited amounts of falling dirt. (NEMA Standard 7-15-1991.)

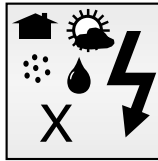

Type 4X

Enclosures are intended for indoor or outdoor use primarily to provide a degree of protection against corrosion, windblown dust and rain, splashing water, hose-directed water and damage from external ice formation. (NEMA Standard 1-10-1979)



Type 3R

Enclosures are intended for outdoor use primarily to provide a degree of protection against rain, sleet and damage from external ice formation. (NEMA Standard 7-15-1991.)

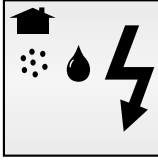

Type 12

Enclosures are intended for indoor use primarily to provide a degree of protection against circulating dust, falling dirt, and dripping noncorrosive liquids. (NEMA Standard 7-15-1991.)



Type 4

Enclosures are intended for indoor or outdoor use primarily to provide a degree of protection against windblown dust and rain, splashing water, hose-directed water and damage from external ice formation. (NEMA Standard 1-10-1979.)

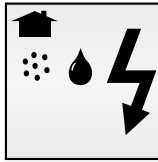

Type 13

Enclosures are intended for indoor use primarily to provide a degree of protection against dust, spraying of water, oil and noncorrosive coolant. (NEMA Standard 1-10-1979.)

Definitions pertaining to hazardous locations

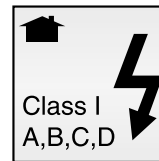

Type 7

Enclosures are intended for indoor use in locations classified as Class I, Groups A, B, C, or D, as defined in the National Electrical Code. (NEMA Standard 7-15-1991.)

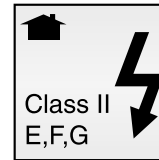

Type 9

Enclosures are intended for indoor use in locations classified as Class II, Groups E, F, or G, as defined in the National Electrical Code. (NEMA Standard 7-15-1991.)

Catalog Symbol	Page	Catalog Symbol	Page	Catalog Symbol	Page	Catalog Symbol	Page	Catalog Symbol	Page
BBDHK	55	BDNF3150	30, 50, 57, 59, 61, 67	BDZW30	6, 25	CDH7S	36	CDS99P	4, 32
BD3RL	17, 55	BDNF31502	5	BDZW30X	6	CDH8S	36	CDSA1	34
BDAUX1	13, 47, 51, 85	BDNF31504	50	BDZW4	6, 25	CDH9S	36	CDSA2	34
BDAUX12	43, 85	BDNF400	30, 46, 57, 59, 61, 65	BDZW5	6, 25	CDHXB12	11, 46, 50, 86	CDSA3	34
BDAUX13	43, 85	BDNF4002	46	BDZW9	15, 27, 53	CDHXB22	11, 46, 50, 70	CDSWM5X8	32
BDAUX14	43	BDNF4004	46	BDZW95	9, 14, 44, 48, 49, 52	CDHXB65	4, 32, 70, 86	CDT-E	34
BDAUX15	43	BDNF600A	30, 46, 57, 59, 61, 65	BDZX108	14, 48	CDHXB86	7, 39, 70	CDTL-ST	34
BDAUX157	5	BDNF600A2	46	BDZX131	43	CDHXB88	42, 86	CDTL-ZX58	34
BDAUX16	43	BDNF600A4	46	BDZX167	9, 40	CDHXY12	11, 46, 50, 86	CDTS100T1	38
BDAUX17	43	BDNF800A	30, 46, 57, 59, 61, 66	BDZX190	13	CDHXY22	11, 46, 50, 70	CDTS100T3	38
BDAUX2	13, 47, 51, 85	BDNF800A2	46	BDZX191	13	CDHXY65	4, 32, 70, 86	CDTS125T1	34
BDAUX3	13, 47, 51	BDNF800A4	46	BDZX196	13	CDHXY86	7, 39, 70	CDTS125T3	34
BDAUX4	13, 47, 51	BDS130	39	BDZX197	13	CDHXY88	42, 86	CDTS32T1	34, 38
BDAUX5	13, 47, 51	BDS140	42	BDZX204	13	CDHZX6	37	CDTS32T3	34, 38
BDAUX6	13, 47, 51	BDS150	7, 39	BDZX213	13	CDL100D	36	CDTS63T1	34, 38
BDBUS114	51	BDS210	7, 16, 39, 54	BDZX216	13	CDL125P	33	CDTS63T3	34, 38
BDBUS115	51	BDS220	12	BDZX271	13	CDL32D	37	CDZK19	9, 41
BDDHK	17	BDS240	42, 54	BDZX272	13	CDL32P	33	CDZT123	44
BDFHNHS12	17, 55	BDS250	12	BDZX273	13	CDL63D	37	CDZW10	41
BDFHNHS4	17, 55	BDS280	12, 46, 50	BDZX71	47, 52	CDL63P	33	CDZW17	35
BDFHS12	17, 55	BDS28045	12, 46, 51	BDZX73	47	CDMB160	40	CDZW6	35
BDFHS17	17, 55	BDS290	7, 39	BDZX74	16, 54	CDMC1	42	CDZW8	35
BDFHS22	17, 55	BDS325	12, 16, 46, 50, 54	BDZX85	47	CDMC2	31	CDZX129	43
BDFLNF100-F	55	BDS32545	12, 46, 51	BDZX90	52	CDN100D	37	CDZX5	40
BDFLNF100-S	54	BDS340	42	BDZX95	40	CDN125P	33	CFC60J	8
BDFLNF175-S	54	BDS360	7, 39	BDZXB	6	CDN160P	40	CFVVR100	8
BDFLNF200A-F	55	BDS395	12, 46, 50	CDAUX01	8, 33, 37, 85	CDN32D	37	CFD100J3	2, 7, 18, 19, 20, 22
BDFLNF200A-S	54	BDS430	7, 39	CDAUX10	5, 8, 33, 37, 85	CDN32P	33	CFD100J3F	17
BDFLNF30-F	55	BDS465	12, 46, 50	CDAUX11	33, 37	CDN63D	37	CFD100J3S	16
BDFLNF30-S	54	BDS46545	12, 46, 51	CDAUX16011	40	CDN63P	33	CFD100J4	7
BDFLNF400-S	54	BDS500	42	CDAUXB160	40	CDNF100	29, 31, 56, 58, 60, 62	CFD30CC3	2, 3, 18, 19, 20, 21
BDFLNF600A-S	54	BDS535	12, 46, 50	CDAUXCA01	40, 85	CDNF100D	36, 63	CFD30CC3F	17
BDFLNF60-F	55	BDST25	7, 39	CDAUXCA10	40, 85	CDNF16	29, 31, 56, 58, 60, 62	CFD30CC3S	16
BDFLNF60-S	54	BDST29	7, 39	CDAUXB	5	CDNF160	29, 39, 56, 58, 60	CFD30CC4	3
BDH104	4, 32	BDST30	7, 39	CDY67121	5	CDNF160-2	39	CFD30J3	2, 3, 18, 19, 20, 21
BDH105	4, 32	BDST4	7, 39	CDY68005	41	CDNF160D	39	CFD30J3F	17
BDH106	4, 32, 70, 86	BDT5F2	13	CDBY68140	38	CDNF16D	36, 63	CFD30J3S	16
BDH106SH	16, 54	BDT5F4	13	CDBY68306	32	CDNF175A	64	CFD30J4	3
BDH106T	4	BDT5F6	13	CDBY68419/1	32	CDNF25	29, 31, 56, 58, 60, 62	CFD60J3	2, 7, 18, 19, 20, 21
BDH107	4, 32, 70, 86	BDA1	8	CDD100D	37	CDNF25D	36, 63	CFD60J3F	17
BDH107SH	16, 54	BDA2	12	CDD125P	33	CDNF30	29, 31, 56, 58, 60, 62	CFD60J3S	16
BDH107T	4	BDA4	12	CDD32D	33	CDNF30D	36, 63	CFD60J4	7
BDH108	42	BDA6	12	CDD32P	37	CDNF32	29, 31, 56, 58, 60, 62	CFDAUX01	5
BDH109	42	BDTL175	12, 24, 68	CDD63D	37	CDNF32D	36, 63	CFDZX171	5
BDH110	42, 86	BDTL175/400	12, 24, 47	CDD63P	33	CDNF45	29, 31, 56, 58, 60, 62	CFTS100	8
BDH110SH	16, 54	BDTL24	8, 16, 17, 24, 54, 55	CDE100D	37	CDNF45D	36, 63	CFZ1	8
BDH111	42, 86	BDTL25	12, 16, 24, 43, 54, 55, 68	CDE125P	33	CDNF60	29, 31, 56, 58, 60, 62	CFZ2	8
BDH111SH	16, 54	BDTL253P	43	CDE160P	37	CDNF60D	36, 63	CXBY68100	41
BDH112	11, 46	BDTL26	12, 16, 24, 47, 54, 68	CDE32D	40	CDNF63	29, 31, 56, 58, 60, 62	EFC-----	69-72
BDH113	11, 46	BDTL262	47	CDE32P	33	CDNF63D	36, 63	EFJ-----	69-72
BDH114	11, 46, 50, 86	BDTL27	12, 24, 47, 54, 68	CDE63D	37	CDNF63D	36, 63	EFL-----	69-72
BDH114SH	16, 54	BDTL28	51, 68	CDE63P	33	CDPB1	34, 38	ENF-----	79-84
BDH115	11, 46, 50, 86	BDTL28/2	51, 68	CDEA-01AU	40	CDPB1EN1	34, 38	FD200J2	11
BDH115SH	16, 54	BDTL30	47, 68	CDEA-10AU	40	CDPB2	34, 38	FD200J3	2, 11, 18, 19, 20, 22
BDH116	11, 46, 50, 70	BDTL32	47, 51	CDEA-ZX01	40	CDPB2EN1	34, 38	FD200J3-S	16
BDH117	11, 46, 50, 70	BDTL550	24	CDEA-ZX10	40	CDPY1	34, 38	FD200J4	11
BDH120	7	BDBTP85	13	CDEA-ZX140	44	CDPY1EN1	34, 38	FD400J2	11
BDH121	7	BDBTP88	13	CDETL-TZ100	48	CDPY2EN1	34, 38	FD400J3	2, 11, 18, 19, 20, 23
BDH58	7, 39, 70	BDBTS12	51	CDETL-ZT80A*	14, 44, 48, 52	CDS100D	37	FD400J3-S	16
BDH59	7, 39, 70	BDBTS2	43	CDETL-ZT80L*	14, 44, 48, 52	CDS105S	3, 31	FD400J4	11
BDH60	39	BDBTS4	47	CDETL-ZW16	9, 34, 40, 44	CDS120S	3, 31	FD600J2	11
BDH61	39	BDBTS6A	47	CDETL-ZW5	14, 48, 52	CDS125P	33	FD600J3	2, 11, 18, 19, 20, 23
BDH79	4	BDBTS8A	47	CDH10S	36	CDS130S	3, 31	FD600J4	11
BDH8	11, 46, 50, 70, 86	BDZD28	5	CDH11S	36	CDS160P	40	FD800L2	11
BDNF1200	30, 50, 57, 59, 61, 66	BDZD48	5	CDH12S	36	CDS180S	3, 31	FD800L3	2, 11, 18, 19, 20, 23
BDNF12002	50	BDZW1	10, 26, 41	CDH13S	36	CDS250S	3, 31	FD800L4	11
BDNF12004	50	BDZW10	10	CDH14S	36	CDS32D	37	FDSBZK98	14
BDNF1600	30, 50, 57, 59, 61, 67	BDZW12	15, 27, 49, 53	CDH15S	31	CDS32P	33	FDSBZL79	14
BDNF16002	50	BDZW13	15, 28, 49, 53	CDH16S	31	CDS330S	3, 31	NDNA100	5, 8, 34
BDNF16004	50	BDZW14	15, 28, 49	CDH17S	36	CDS340T	42	NDNA200	5, 8, 34
BDNF175	57, 59, 61	BDZW15	15, 28, 49, 53	CDH18S	36	CDS48P	4, 32	NNB-R	5
BDNF175A	30, 42	BDZW18	45	CDH19S	36	CDS48T	32	OPMRH	32
BDNF175A2	42	BDZW19	45	CDH1S	31	CDS49P	4, 32		
BDNF175A4	42	BDZW1X	10, 41	CDH20S	31	CDS49T	32		
BDNF2000	30, 50, 57, 59, 61, 67	BDZW2	10, 26, 41	CDH2S	36	CDS50P	4, 32		
BDNF20002	50	BDZW20	45	CDH3S	3, 31	CDS63D	37		
BDNF20004	50	BDZW20X	45	CDH4	7	CDS63P	33		
BDNF200A	30, 42, 57, 59, 61, 64	BDZW21	45	CDH4S	3, 31	CDS67P	4, 16, 32, 54		
BDNF200A2	42	BDZW21X	45	CDH5S	3, 31, 70, 86	CDS67T	32		
BDNF200A4	42	BDZW3	15, 28, 49	CDH6S	3, 31, 70, 86	CDS65S	3, 31		

The Paul P. Gubany Center

For High Power Technology

Setting A New Standard For Product Performance Evaluation

- The Gubany Center provides the industry's most advanced staging area for observing circuit protection devices under high current or short circuit conditions.
- The Center is capable of generating 300,000 amperes of current at 600 volts under carefully controlled conditions, offering a wider range of current, voltage and frequency configurations than any other center of its kind in the world.
- Built to exceed the short-circuit capacity of today's high power electrical distribution systems, the Gubany Center makes it possible for Bussmann to evaluate the reliability and performance of our products under the most extreme fault conditions. The Center provides a real-world proving ground for the industry's most advanced circuit protection technology.
- Bussmann understands the crucial role its circuit protection products play in industrial applications. Our customers need performance—not promises—when it comes to protecting electrical equipment from the damaging effects of short circuits.



Bussmann®

The recognized leader in circuit protection technology

Bussmann®

Worldwide Circuit Protection Solutions

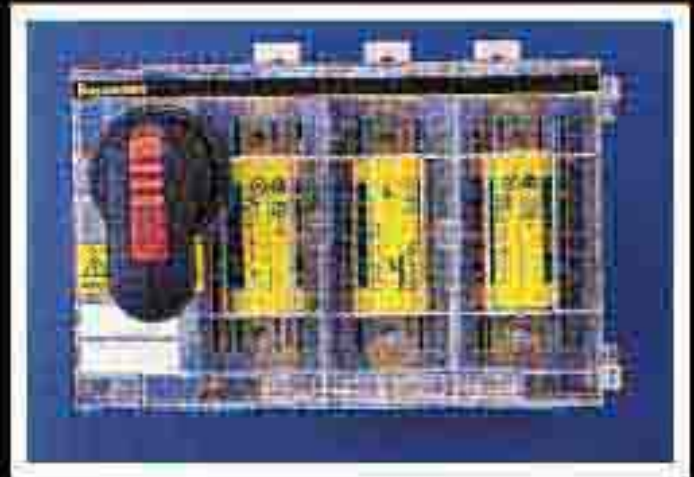
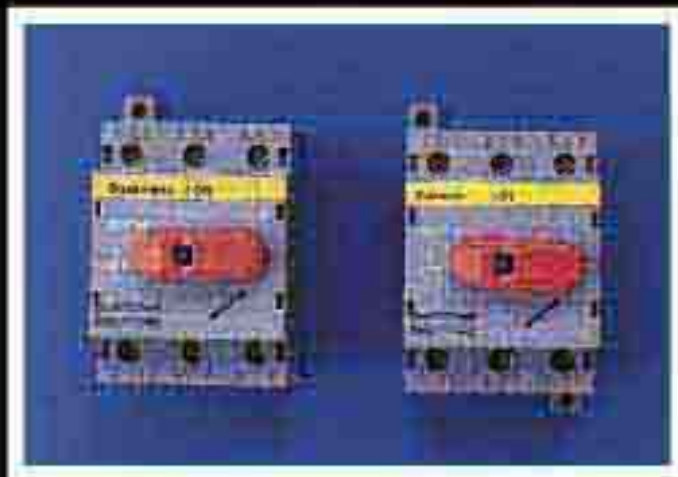

COOPER Bussmann

ST. LOUIS, MO 63178-4460 • (636) 394-2877
World Wide Web: www.bussmann.com