

TIP125/TIP126/TIP127 PNP Epitaxial Darlington Transistor

- Medium Power Linear Switching Applications
- Complementary to TIP120/121/122

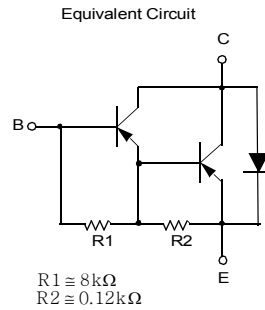
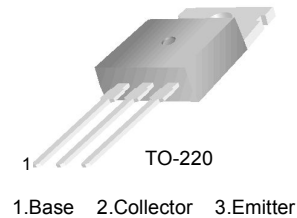

Absolute Maximum Ratings* $T_a = 25^\circ\text{C}$ unless otherwise noted

Symbol	Parameter	Ratings	Units
V_{CBO}	Collector-Base Voltage : TIP125	- 60	V
	: TIP126	- 80	V
	: TIP127	- 100	V
V_{CEO}	Collector-Emitter Voltage : TIP125	- 60	V
	: TIP126	- 80	V
	: TIP127	- 100	V
V_{EBO}	Emitter-Base Voltage	- 5	V
I_C	Collector Current (DC)	- 5	A
I_{CP}	Collector Current (Pulse)	- 8	A
I_B	Base Current (DC)	- 120	mA
P_C	Collector Dissipation ($T_a=25^\circ\text{C}$)	2	W
	Collector Dissipation ($T_C=25^\circ\text{C}$)	65	W
T_J	Junction Temperature	150	$^\circ\text{C}$
T_{STG}	Storage Temperature	- 65 ~ 150	$^\circ\text{C}$

* These ratings are limiting values above which the serviceability of any semiconductor device may be impaired.

Electrical Characteristics* $T_a = 25^\circ\text{C}$ unless otherwise noted

Symbol	Parameter	Test Condition	Min.	Typ.	Max.	Units
$V_{CEO(sus)}$	Collector-Emitter Sustaining Voltage : TIP125 : TIP126 : TIP127	$I_C = -100\text{mA}, I_B = 0$	-60 -80 -120			V V V
I_{CEO}	Collector Cut-off Current : TIP125 : TIP126 : TIP127	$V_{CE} = -30\text{V}, I_B = 0$ $V_{CE} = -40\text{V}, I_B = 0$ $V_{CE} = -50\text{V}, I_B = 0$			-2 -2 -2	mA mA mA
I_{CBO}	Collector Cut-off Current : TIP125 : TIP126 : TIP127	$V_{CB} = -60\text{V}, I_E = 0$ $V_{CB} = -80\text{V}, I_E = 0$ $V_{CB} = -100\text{V}, I_E = 0$			-1 -1 -1	mA mA mA
I_{EBO}	Emitter Cut-off Current	$V_{BE} = -5\text{V}, I_C = 0$			-2	mA
h_{FE}	* DC Current Gain	$V_{CE} = -3\text{V}, I_C = 0.5\text{A}$ $V_{CE} = -3\text{V}, I_C = -3\text{A}$	1000 1000			
$V_{CE(sat)}$	* Collector-Emitter Saturation Voltage	$I_C = -3\text{A}, I_B = -12\text{mA}$ $I_C = -5\text{A}, I_B = -20\text{mA}$			-2 -4	V V
$V_{BE(on)}$	* Base-Emitter On Voltage	$V_{CE} = -3\text{V}, I_C = -3\text{A}$			-2.5	V
C_{ob}	Output Capacitance	$V_{CB} = -10\text{V}, I_E = 0, f = 0.1\text{MHz}$			300	pF

* Pulse Test: Pulse Width $\leq 300\mu\text{s}$, Duty Cycle $\leq 2\%$

Typical Characteristics

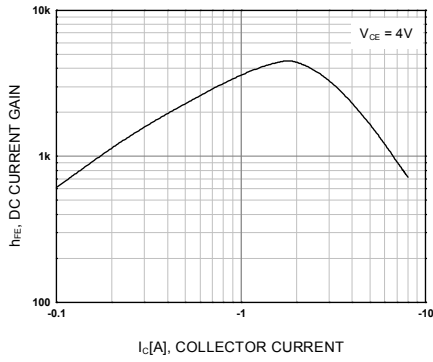

Figure 1. DC current Gain

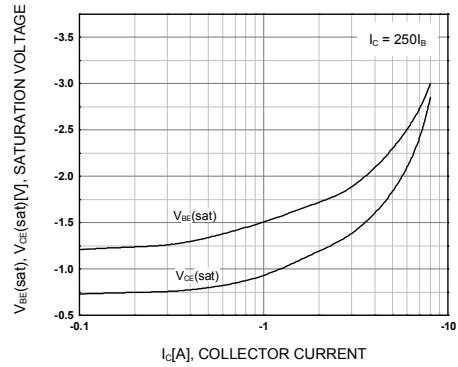

Figure 2. Base-Emitter Saturation Voltage
Collector-Emitter Saturation Voltage

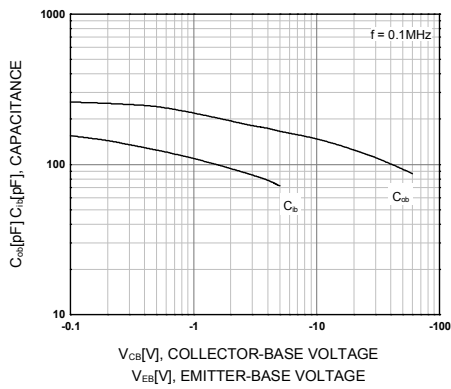

Figure 3. Output and Input Capacitance
vs. Reverse Voltage

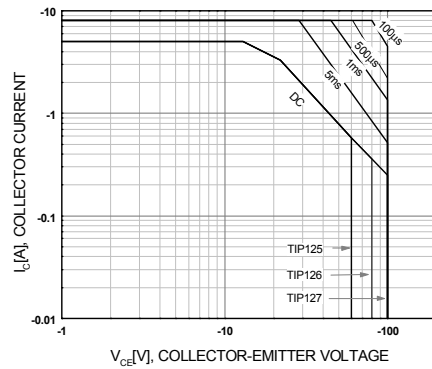

Figure 4. Safe Operating Area

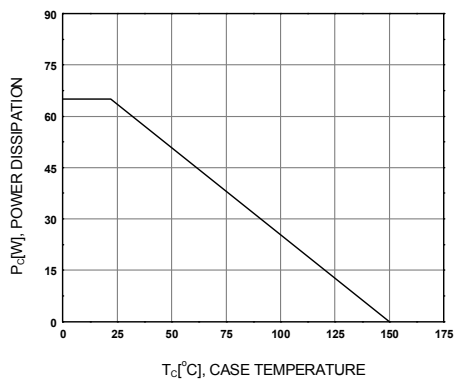
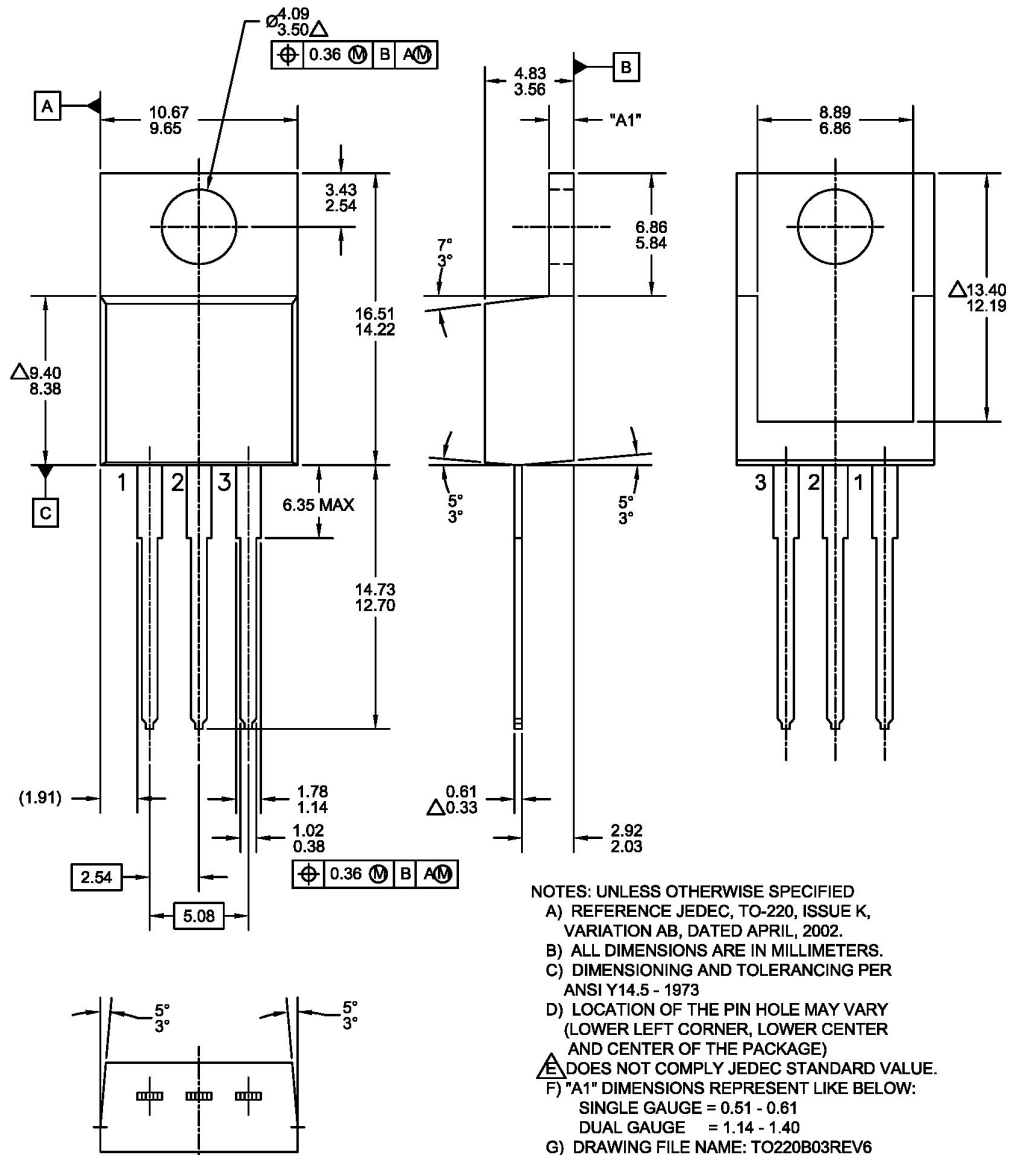

Figure 5. Power Derating

Mechanical Dimensions

TO220



- NOTES: UNLESS OTHERWISE SPECIFIED
- A) REFERENCE JEDEC, TO-220, ISSUE K, VARIATION AB, DATED APRIL, 2002.
 - B) ALL DIMENSIONS ARE IN MILLIMETERS.
 - C) DIMENSIONING AND TOLERANCING PER ANSI Y14.5 - 1973
 - D) LOCATION OF THE PIN HOLE MAY VARY (LOWER LEFT CORNER, LOWER CENTER AND CENTER OF THE PACKAGE)
 - Δ DOES NOT COMPLY JEDEC STANDARD VALUE.
 - F) "A1" DIMENSIONS REPRESENT LIKE BELOW:
 SINGLE GAUGE = 0.51 - 0.61
 DUAL GAUGE = 1.14 - 1.40
 - G) DRAWING FILE NAME: TO220B03REV6

TIP125/TIP126/TIP127 — PNP Epitaxial Darlington Transistor



TRADEMARKS

The following are registered and unregistered trademarks and service marks Fairchild Semiconductor owns or is authorized to use and is not intended to be an exhaustive list of all such trademarks.

ACEx®	Green FPS™	Power247®	SuperSOT™-8
Build it Now™	Green FPS™ e-Series™	POWEREDGE®	SyncFET™
CorePLUS™	GTO™	Power-SPM™	The Power Franchise®
CROSSVOLT™	i-Lo™	PowerTrench®	power the franchise
CTL™	IntelliMAX™	Programmable Active Droop™	TinyBoost™
Current Transfer Logic™	ISOPLANAR™	QFET®	TinyBuck™
EcoSPARK®	MegaBuck™	QS™	TinyLogic®
F ®	MICROCOUPLER™	QT Optoelectronics™	TINYOPTO™
Fairchild®	MicroFET™	Quiet Series™	TinyPower™
Fairchild Semiconductor®	MicroPak™	RapidConfigure™	TinyPWM™
FACT Quiet Series™	MillerDrive™	SMART START™	TinyWire™
FACT®	Motion-SPM™	SPM®	µSerDes™
FAST®	OPTOLOGIC®	STEALTH™	UHC®
FastvCore™	OPTOPLANAR®	SuperFET™	UniFET™
FPS™	 ®	SuperSOT™-3	VCX™
FRFET®	PDP-SPM™	SuperSOT™-6	
Global Power ResourceSM	Power220®		

DISCLAIMER

FAIRCHILD SEMICONDUCTOR RESERVES THE RIGHT TO MAKE CHANGES WITHOUT FURTHER NOTICE TO ANY PRODUCTS HEREIN TO IMPROVE RELIABILITY, FUNCTION, OR DESIGN. FAIRCHILD DOES NOT ASSUME ANY LIABILITY ARISING OUT OF THE APPLICATION OR USE OF ANY PRODUCT OR CIRCUIT DESCRIBED HEREIN; NEITHER DOES IT CONVEY ANY LICENSE UNDER ITS PATENT RIGHTS, NOR THE RIGHTS OF OTHERS. THESE SPECIFICATIONS DO NOT EXPAND THE TERMS OF FAIRCHILD'S WORLDWIDE TERMS AND CONDITIONS, SPECIFICALLY THE WARRANTY THEREIN, WHICH COVERS THESE PRODUCTS.

LIFE SUPPORT POLICY

FAIRCHILD'S PRODUCTS ARE NOT AUTHORIZED FOR USE AS CRITICAL COMPONENTS IN LIFE SUPPORT DEVICES OR SYSTEMS WITHOUT THE EXPRESS WRITTEN APPROVAL OF FAIRCHILD SEMICONDUCTOR CORPORATION.

As used herein:

1. Life support devices or systems are devices or systems which, (a) are intended for surgical implant into the body, or (b) support or sustain life, and (c) whose failure to perform when properly used in accordance with instructions for use provided in the labeling, can be reasonably expected to result in significant injury to the user.
2. A critical component is any component of a life support device or system whose failure to perform can be reasonably expected to cause the failure of the life support device or system, or to affect its safety or effectiveness.

PRODUCT STATUS DEFINITIONS

Definition of Terms

Datasheet Identification	Product Status	Definition
Advance Information	Formative or In Design	This datasheet contains the design specifications for product development. Specifications may change in any manner without notice.
Preliminary	First Production	This datasheet contains preliminary data; supplementary data will be published at a later date. Fairchild Semiconductor reserves the right to make changes at any time without notice to improve design.
No Identification Needed	Full Production	This datasheet contains final specifications. Fairchild Semiconductor reserves the right to make changes at any time without notice to improve design.
Obsolete	Not In Production	This datasheet contains specifications on a product that has been discontinued by Fairchild semiconductor. The datasheet is printed for reference information only.

Rev. I31