

CURRENT COMPENSATED NOISE SUPPRESSION CHOKES

FE 2X Series - 2 Phase Common Mode Choke

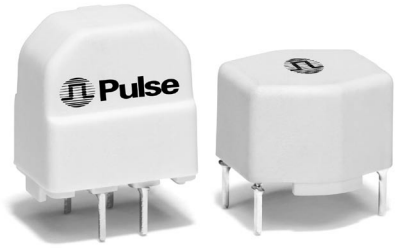
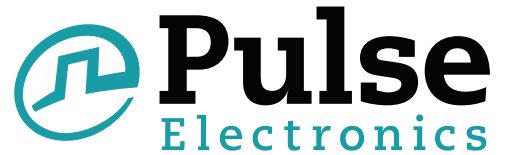

- Complies with VDE 565-2
- Materials meet UL-94V0 requirements
- Rated voltage: 250 Vac
- Withstanding voltage: 1500 Vac

Electrical Specifications @ 25°C — Operating Temperature -40°C to +125°C

Part Number (Vertical)	Part Number (Horizontal)	L (mH ±30%)	Current (A)	DCR (Ω ±20%)	Resonance (kHz)
FE2X03-3-2	FE2X03-3-3	3.3	1.50	0.17	800
FE2X03-4-2	FE2X03-4-3	3.3	2.50	0.07	700
FE2X03-5-2	—	3.3	2.80	0.06	700
FE2X03-6-2	—	3.3	4.00	0.06	700
—	FE2X03-8-3	3.3	8.00	0.028	700
FE2X07-3-2	FE2X07-3-3	6.8	1.20	0.30	400
FE2X07-5-2	FE2X07-5-3	6.8	2.00	0.14	450
FE2X07-6-2	—	6.8	2.20	0.17	450
FE2X10-3-2	FE2X10-3-3	10	0.70	0.55	350
FE2X10-4-2	FE2X10-4-3	10	1.20	0.30	350
FE2X10-5-2	—	10	1.60	0.21	300
FE2X10-6-2	—	10	1.80	0.20	300
FE2X15-3-2	FE2X15-3-3	15	0.50	0.77	300
FE2X15-4-2	—	15	1.00	0.40	220
FE2X18-6-2	—	18	1.40	0.28	200
FE2X27-3-2	FE2X27-3-3	27	0.40	1.70	180
FE2X27-4-2	FE2X27-4-3	27	0.70	0.62	180
FE2X39-3-2	FE2X39-3-3	39	0.35	2.00	160
FE2X39-4-2	FE2X39-4-3	39	0.50	1.12	160
FE2X39-5-2	—	39	0.70	1.00	160
FE2X47-3-2	—	47	0.30	2.30	150
FE2X47-4-2	—	47	0.40	1.30	150

NOTE: Part Numbering System: FEXLV-S-P, where LV is the inductance value, S is the size code, and P is package style (2 = vertical and 3 = horizontal)

Schematics

Style 2 - Vertical Package

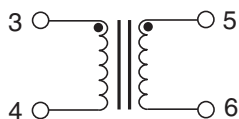

Style 3 - Horizontal Package

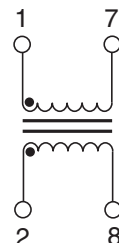

CURRENT COMPENSATED NOISE SUPPRESSION CHOKES

FE 2X Series - 2 Phase Common Mode Choke

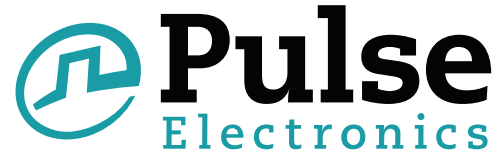

Mechanicals

Style 2 - Vertical Package

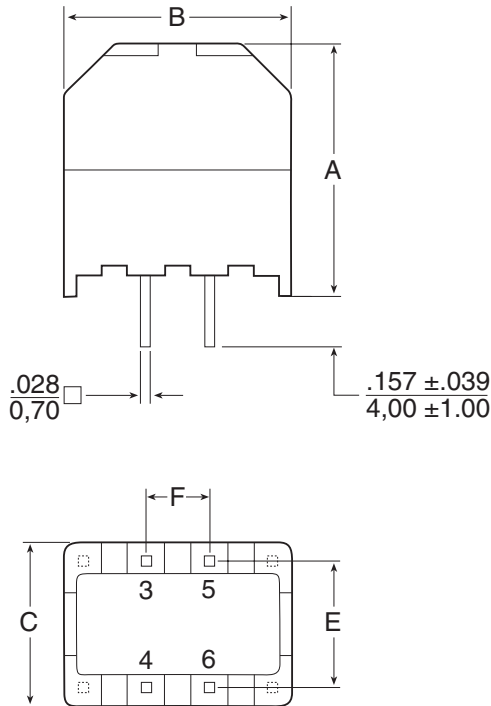

PINS VIEW

Size Code	A MAX	B MAX	C MAX	E	F
3	.803 20,40	.724 18,40	.528 13,40	.394 10,00	.197 5,00
4	1.000 25,40	.921 23,40	.626 15,90	.492 12,50	.394 10,00
5	1.197 30,40	1.079 27,40	.724 18,40	.591 15,00	.492 12,50
6	1.394 35,40	1.276 32,40	.724 18,40	.591 15,00	.492 12,50

NOTE: Tolerances for E & F are ±.010 / 0,25

Style 3 - Horizontal Package

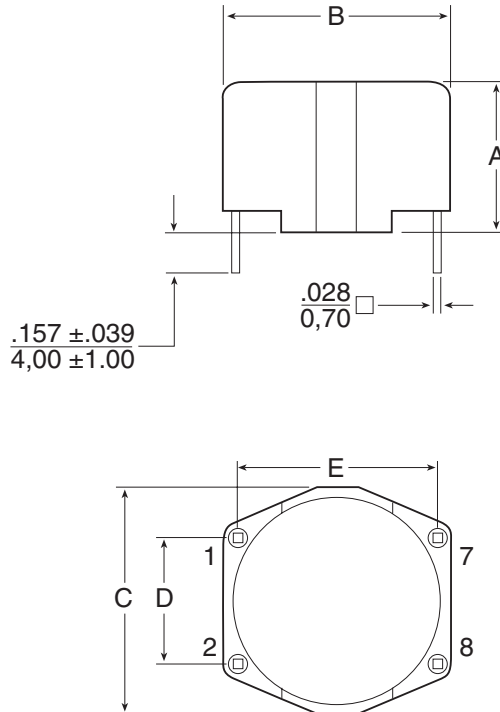

PINS VIEW

Size Code	A MAX	B MAX	C MAX	D	E
3	.508 12,90	.705 17,90	.705 17,90	.394 10,00	.591 15,00
4	.606 15,40	.902 22,90	.902 22,90	.492 12,50	.787 20,00
5	.705 17,90	1.098 27,90	1.098 27,90	.591 15,00	.984 25,00
8	1.000 25,40	1.709 43,40	1.669 42,40	.591 15,00	1.575 40,00

NOTE: Tolerances for D & E are ±.010 / 0,25

For More Information:

Pulse North American Headquarters
12220 World Trade Dr.
San Diego, CA 92128
U.S.A.

Pulse European Headquarters
Einsteinstrasse 1
D-71083 Herrenberg
Germany

Pulse China Headquarters
B402, Shenzhen Academy of
Aerospace Technology Bldg.
10th Kejinan Rd.
High-Tech Zone
Nanshan District
Shenzhen, PR China 518057

Pulse North China
Room 1503
XinYin Building
No. 888 YiShan Rd.
Shanghai 200233
China

Pulse South Asia
150 Kampong Ampat
#07-01/02
KA Centre
Singapore 368324

Pulse North Asia
No. 26
Kao Ching Rd.
Yang Mei Chen
Taoyuan Hsien
Taiwan, R. O. C.
32667

TEL: 858 674 8100
FAX: 858 674 8262

TEL: 49 7032 7806 0
FAX: 49 7032 7806 12

TEL: 86 755 33966678
FAX: 86 755 33966700

TEL: 86 21 32181071
FAX: 86 21 32181396

TEL: 65 6287 8998
FAX: 65 6280 0080

TEL: 886 3 4643715
FAX: 886 3 4641911

Performance warranty of products offered on this data sheet is limited to the parameters specified. Data is subject to change without notice. Other brand and product names mentioned herein may be trademarks or registered trademarks of their respective owners. Pulse and the Squarewave logo are trademarks of Pulse Electronics Corporation, registered in the U.S. and other countries. © Copyright, 2011. Pulse Electronics Corporation. All rights reserved.