

**HIGH ISOLATION VOLTAGE
SOP MULTI PHOTOCOUPLER**

-NEPOC Series-

DESCRIPTION

The PS2701-1 is an optically coupled isolator containing a GaAs light emitting diode and an NPN silicon phototransistor.

This package is SOP (Small Outline Package) type and has shield effect to cut off ambient light.

It is designed for high density mounting applications.

FEATURES

- High isolation voltage ($BV = 3\,750\text{ V r.m.s.}$)
 - SOP (Small Outline Package) type
 - High-speed switching ($t_r = 3\ \mu\text{s TYP.}$, $t_f = 5\ \mu\text{s TYP.}$)
 - Ordering number of taping product: PS2701-1-F3, F4
 - Safety standards
 - UL approved: No. E72422
 - BSI approved: No. 8219/8220
 - CSA approved: No. CA 101391
- <R> • DIN EN60747-5-2 (VDE0884 Part2) approved: No. 40008902 (Option)

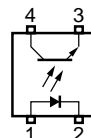
**PIN CONNECTION
(Top View)**

1. Anode
2. Cathode
3. Emitter
4. Collector

APPLICATIONS

- Hybrid IC
- Measuring instruments
- Power supply
- Programmable logic controllers

The information in this document is subject to change without notice. Before using this document, please confirm that this is the latest version.

PACKAGE DIMENSIONS (in millimeters)

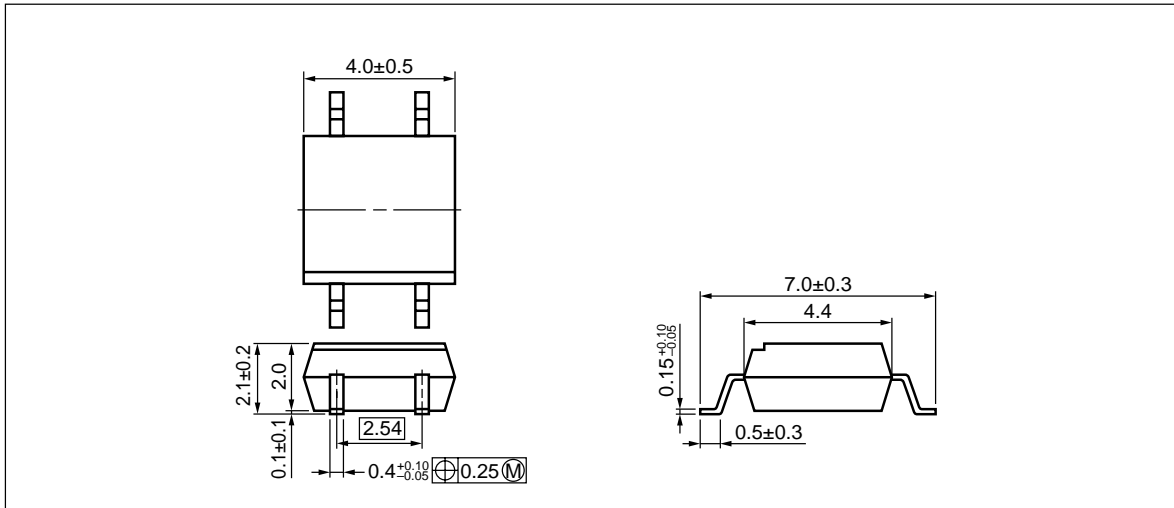

<R> MARKING EXAMPLE

Pb-Free

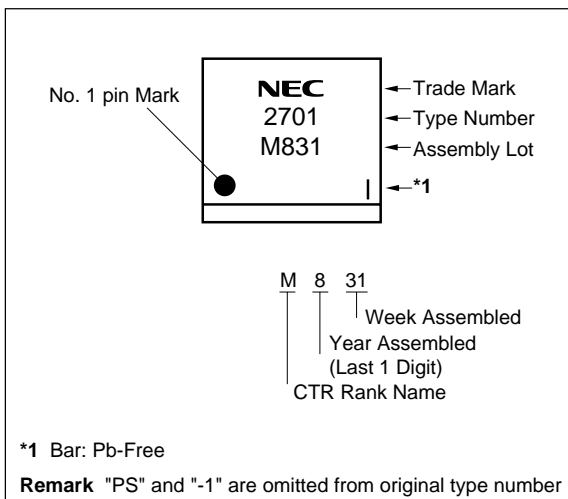

Special version (Pb-Free and Halogen Free)

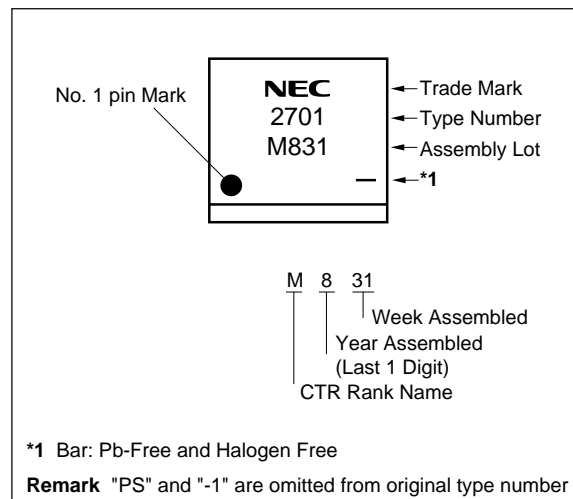

<R> **ORDERING INFORMATION**

Part Number	Order Number	Solder Plating Specification	Packing Style	Safety Standard Approval	Application Part Number*1	
PS2701-1	PS2701-1-A	Pb-Free	Magazine case 100 pcs	Standard products (UL, BSI, CSA approved)	PS2701-1	
PS2701-1-F3	PS2701-1-F3-A		Embossed Tape 3 500 pcs/reel			
PS2701-1-F4	PS2701-1-F4-A		Magazine case 100 pcs	DIN EN60747-5-2 (VDE0884 Part2)		
PS2701-1-V	PS2701-1-V-A					
PS2701-1-V-F3	PS2701-1-V-F3-A			Embossed Tape 3 500 pcs/reel		Approved (Option)
PS2701-1-V-F4	PS2701-1-V-F4-A					
PS2701-1	PS2701-1Y-A	Special version	Magazine case 100 pcs	Standard products (UL, BSI, CSA approved)	PS2701-1	
PS2701-1-F3	PS2701-1Y-F3-A	(Pb-Free and Halogen Free)	Embossed Tape 3 500 pcs/reel			
PS2701-1-V	PS2701-1Y-V-A		Magazine case 100 pcs	DIN EN60747-5-2 (VDE0884 Part2)		
PS2701-1-V-F3	PS2701-1Y-V-F3-A		Embossed Tape 3 500 pcs/reel			Approved (Option)

*1 For the application of the Safety Standard, following part number should be used.

ABSOLUTE MAXIMUM RATINGS (T_A = 25°C, unless otherwise specified)

Parameter		Symbol	Ratings	Unit
Diode	Forward Current (DC)	I _F	50	mA
	Reverse Voltage	V _R	6	V
	Power Dissipation Derating	ΔP _D /°C	0.8	mW/°C
	Power Dissipation	P _D	80	mW
	Peak Forward Current ^{*1}	I _{FP}	1	A
Transistor	Collector to Emitter Voltage	V _{CEO}	40	V
	Emitter to Collector Voltage	V _{ECO}	6	V
	Collector Current	I _C	80	mA
	Power Dissipation Derating	ΔP _C /°C	1.5	mW/°C
	Power Dissipation	P _C	150	mW
Isolation Voltage ^{*2}		BV	3 750	Vr.m.s.
Operating Ambient Temperature		T _A	-55 to +100	°C
Storage Temperature		T _{stg}	-55 to +150	°C

*1 PW = 100 μs, Duty Cycle = 1%

*2 AC voltage for 1 minute at T_A = 25°C, RH = 60% between input and output
Pins 1-2 shorted together, 3-4 shorted together.

ELECTRICAL CHARACTERISTICS (T_A = 25°C)

Parameter		Symbol	Conditions	MIN.	TYP.	MAX.	Unit
Diode	Forward Voltage	V _F	I _F = 5 mA		1.1	1.4	V
	Reverse Current	I _R	V _R = 5 V			5	μA
	Terminal Capacitance	C _t	V = 0 V, f = 1 MHz		30		pF
Transistor	Collector to Emitter Dark Current	I _{CEO}	I _F = 0 mA, V _{CE} = 40 V			100	nA
Coupled	Current Transfer Ratio (I _C /I _F) ^{*1}	CTR	I _F = 5 mA, V _{CE} = 5 V	50	100	300	%
	Collector Saturation Voltage	V _{CE(sat)}	I _F = 10 mA, I _C = 2 mA			0.3	V
	Isolation Resistance	R _{I-O}	V _{I-O} = 1 kV _{DC}	10 ¹¹			Ω
	Isolation Capacitance	C _{I-O}	V = 0 V, f = 1 MHz		0.4		pF
	Rise Time ^{*2}	t _r	V _{CC} = 5 V, I _C = 2 mA, R _L = 100 Ω		3		μs
	Fall Time ^{*2}	t _f			5		

***1 CTR rank**

P: 150 to 300 (%)

L: 100 to 300 (%)

M: 50 to 150 (%)

<R>

***2 Test circuit for switching time**

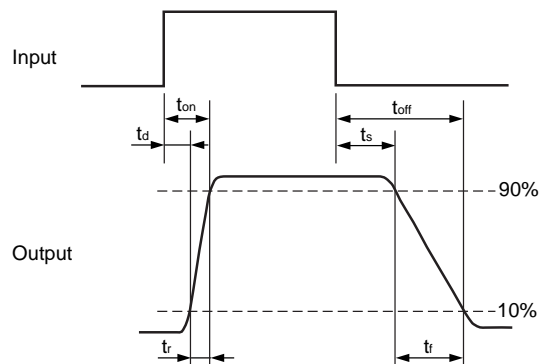
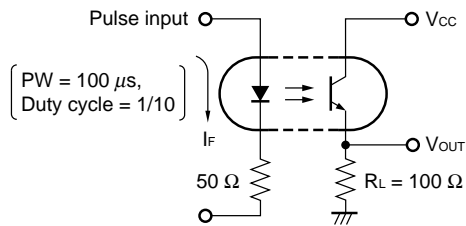

TYPICAL CHARACTERISTICS ($T_A = 25^\circ\text{C}$, unless otherwise specified)

DIODE POWER DISSIPATION vs. AMBIENT TEMPERATURE

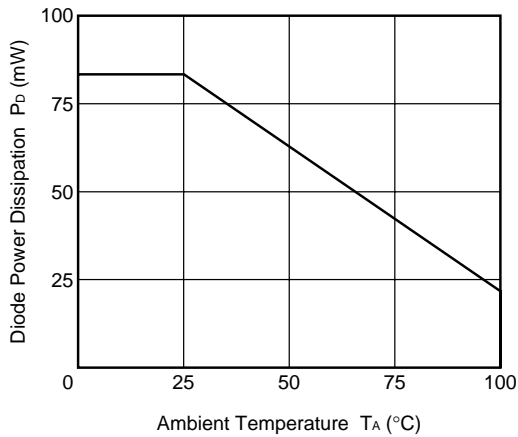

TRANSISTOR POWER DISSIPATION vs. AMBIENT TEMPERATURE

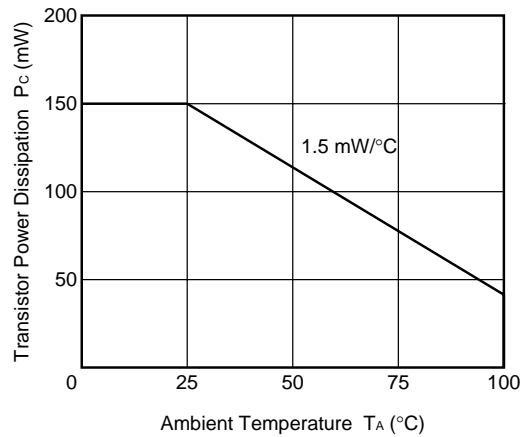

FORWARD CURRENT vs. FORWARD VOLTAGE

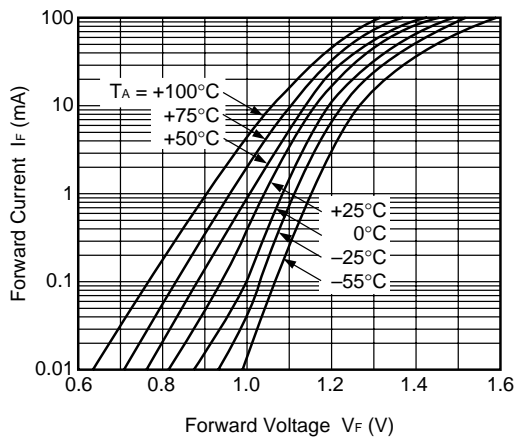

COLLECTOR CURRENT vs. COLLECTOR TO EMITTER VOLTAGE

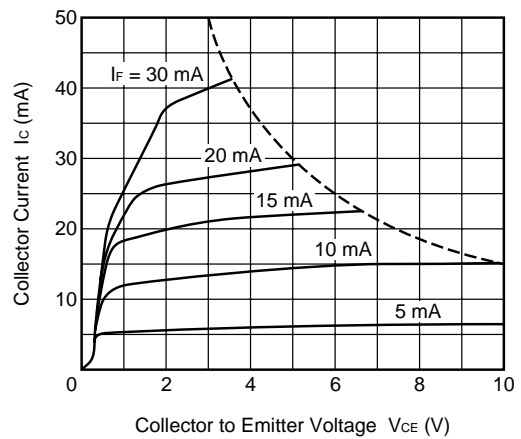

COLLECTOR TO EMITTER DARK CURRENT vs. AMBIENT TEMPERATURE

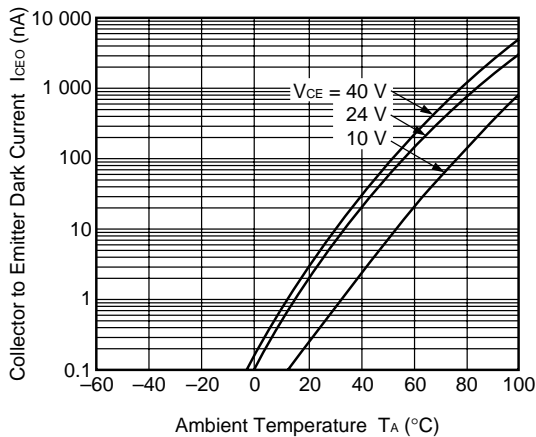

COLLECTOR CURRENT vs. COLLECTOR SATURATION VOLTAGE

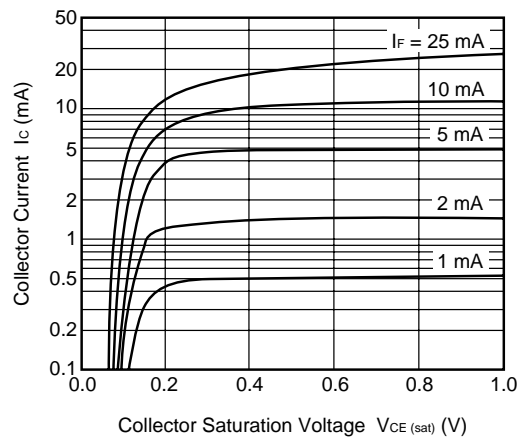

Remark The graphs indicate nominal characteristics.

NORMALIZED CURRENT TRANSFER RATIO vs. AMBIENT TEMPERATURE

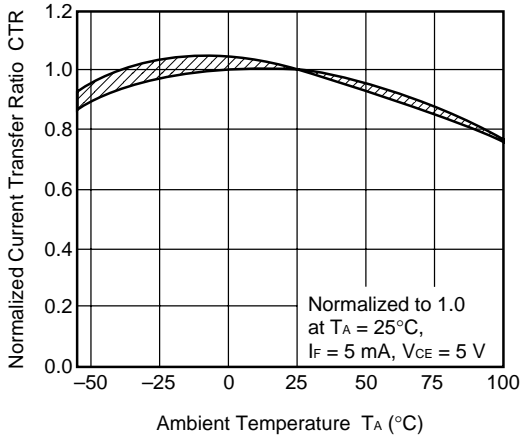

CURRENT TRANSFER RATIO vs. FORWARD CURRENT

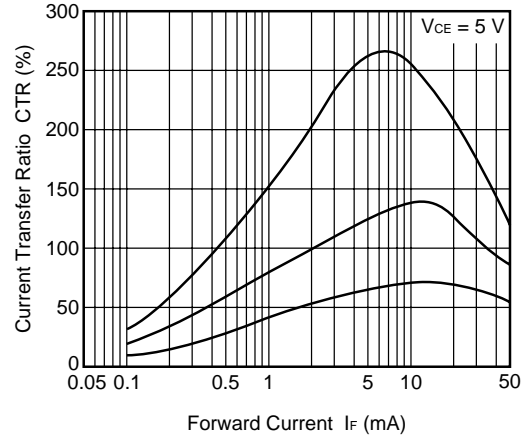

SWITCHING TIME vs. LOAD RESISTANCE

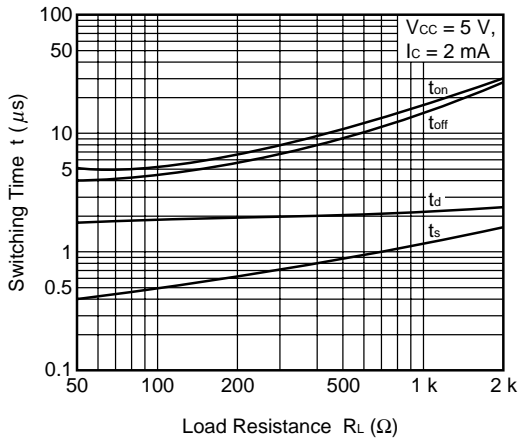

FREQUENCY RESPONSE

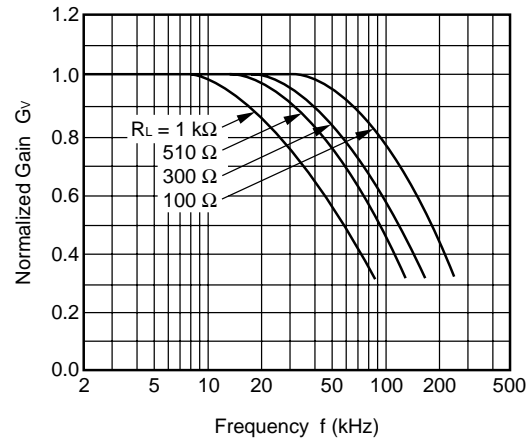

SWITCHING TIME vs. LOAD RESISTANCE

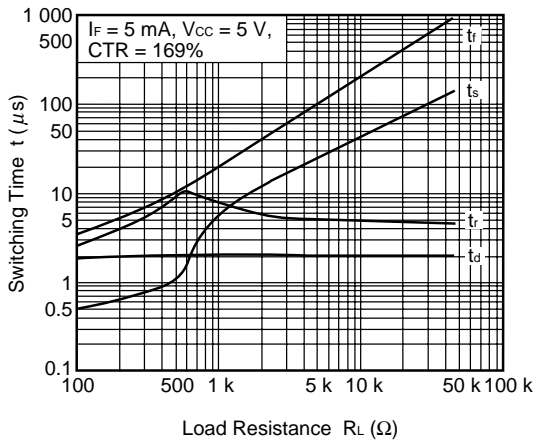

LONG TERM CTR DEGRADATION

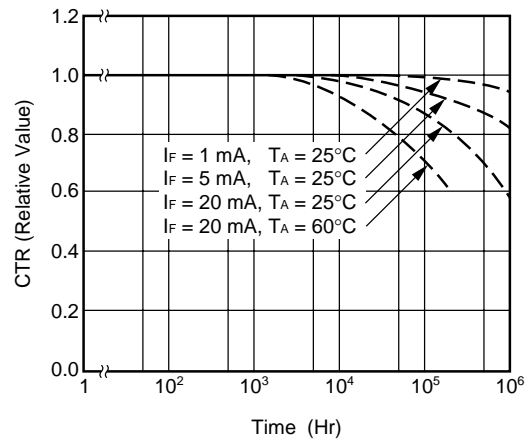

Remark The graphs indicate nominal characteristics.

TAPING SPECIFICATIONS (in millimeters)

Outline and Dimensions (Tape)

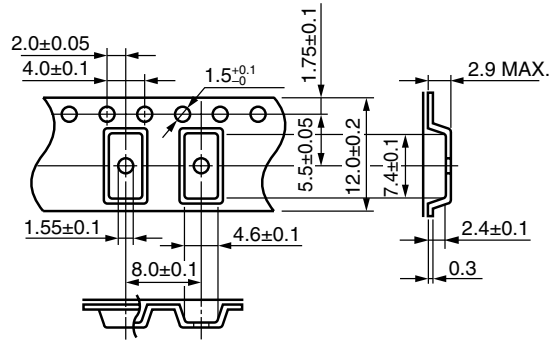

Tape Direction

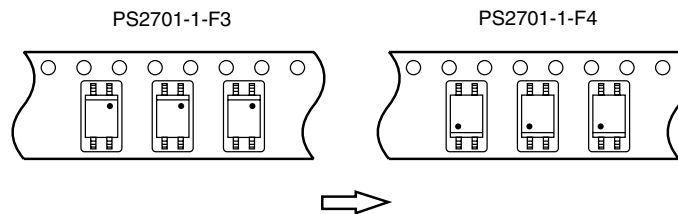

Outline and Dimensions (Reel)

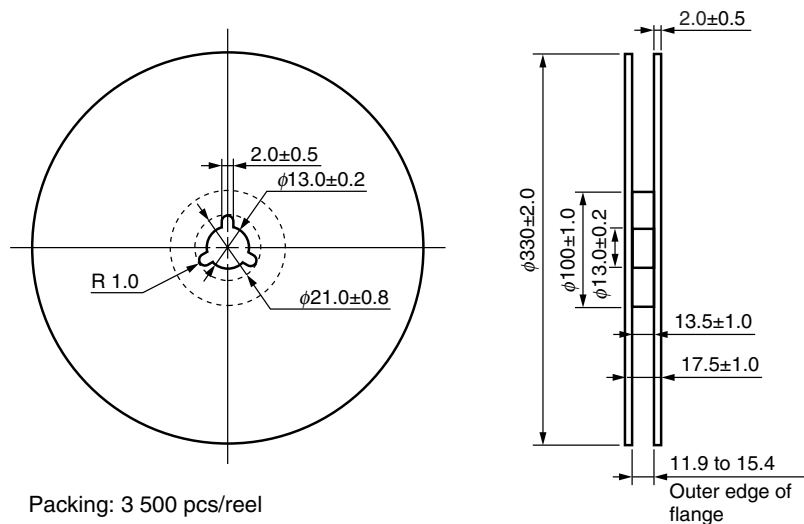

NOTES ON HANDLING

1. Recommended soldering conditions

(1) Infrared reflow soldering

- Peak reflow temperature 260°C or below (package surface temperature)
- Time of peak reflow temperature 10 seconds or less
- Time of temperature higher than 220°C 60 seconds or less
- Time to preheat temperature from 120 to 180°C 120±30 s
- Number of reflows Three
- Flux Rosin flux containing small amount of chlorine (The flux with a maximum chlorine content of 0.2 Wt% is recommended.)

Recommended Temperature Profile of Infrared Reflow

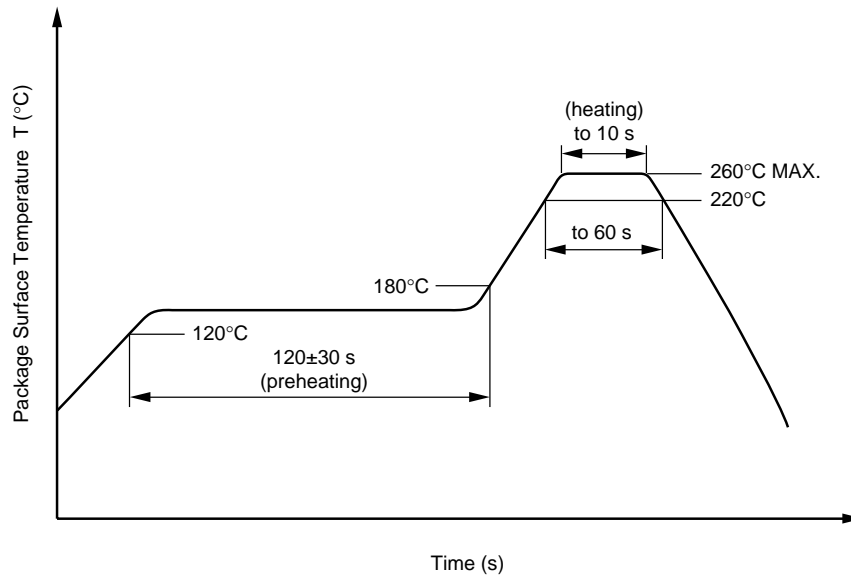

(2) Wave soldering

- Temperature 260°C or below (molten solder temperature)
- Time 10 seconds or less
- Preheating conditions 120°C or below (package surface temperature)
- Number of times One (Allowed to be dipped in solder including plastic mold portion.)
- Flux Rosin flux containing small amount of chlorine (The flux with a maximum chlorine content of 0.2 Wt% is recommended.)

(3) Soldering by soldering iron

- Peak temperature (lead part temperature) 350°C or below
- Time (each pins) 3 seconds or less
- Flux Rosin flux containing small amount of chlorine (The flux with a maximum chlorine content of 0.2 Wt% is recommended.)

- (a) Soldering of leads should be made at the point 1.5 to 2.0 mm from the root of the lead.
- (b) Please be sure that the temperature of the package would not be heated over 100°C.

(4) Cautions

- Fluxes

Avoid removing the residual flux with freon-based and chlorine-based cleaning solvent.

2. Cautions regarding noise

Be aware that when voltage is applied suddenly between the photocoupler's input and output or between collector-emitters at startup, the output transistor may enter the on state, even if the voltage is within the absolute maximum ratings.

3. Measurement conditions of current transfer ratios (CTR), which differ according to photocoupler

Check the setting values before use, since the forward current conditions at CTR measurement differ according to product.

When using products other than at the specified forward current, the characteristics curves may differ from the standard curves due to CTR value variations or the like. This tendency may sometimes be obvious, especially below $I_F = 1$ mA.

Therefore, check the characteristics under the actual operating conditions and thoroughly take variations or the like into consideration before use.

USAGE CAUTIONS

1. Protect against static electricity when handling.
2. Avoid storage at a high temperature and high humidity.

<R> **SPECIFICATION OF VDE MARKS LICENSE DOCUMENT**

Parameter	Symbol	Spec.	Unit
Climatic test class (IEC 60068-1/DIN EN 60068-1)		55/110/21	
Dielectric strength maximum operating isolation voltage Test voltage (partial discharge test, procedure a for type test and random test) $U_{pr} = 1.5 \times U_{IORM}, P_d < 5 \text{ pC}$	U_{IORM} U_{pr}	707 1 060	V_{peak} V_{peak}
Test voltage (partial discharge test, procedure b for all devices) $U_{pr} = 1.875 \times U_{IORM}, P_d < 5 \text{ pC}$	U_{pr}	1 325	V_{peak}
Highest permissible overvoltage	U_{TR}	6 000	V_{peak}
Degree of pollution (DIN EN 60664-1 VDE0110 Part 1)		2	
Clearance distance		>5.0	mm
Creepage distance		>5.0	mm
Comparative tracking index (IEC 60112/DIN EN 60112 (VDE 0303 Part 11))	CTI	175	
Material group (DIN EN 60664-1 VDE0110 Part 1)		III a	
Storage temperature range	T_{stg}	-55 to +150	°C
Operating temperature range	T_A	-55 to +110	°C
Isolation resistance, minimum value $V_{IO} = 500 \text{ V dc at } T_A = 25^\circ\text{C}$ $V_{IO} = 500 \text{ V dc at } T_A \text{ MAX. at least } 100^\circ\text{C}$	Ris MIN. Ris MIN.	10^{12} 10^{11}	Ω Ω
Safety maximum ratings (maximum permissible in case of fault, see thermal derating curve) Package temperature Current (input current I_F , $P_{si} = 0$) Power (output or total power dissipation) Isolation resistance $V_{IO} = 500 \text{ V dc at } T_A = T_{si}$	T_{si} I_{si} P_{si} Ris MIN.	150 300 500 10^9	°C mA mW Ω

- **The information in this document is current as of December, 2008. The information is subject to change without notice. For actual design-in, refer to the latest publications of NEC Electronics data sheets or data books, etc., for the most up-to-date specifications of NEC Electronics products. Not all products and/or types are available in every country. Please check with an NEC Electronics sales representative for availability and additional information.**
- No part of this document may be copied or reproduced in any form or by any means without the prior written consent of NEC Electronics. NEC Electronics assumes no responsibility for any errors that may appear in this document.
- NEC Electronics does not assume any liability for infringement of patents, copyrights or other intellectual property rights of third parties by or arising from the use of NEC Electronics products listed in this document or any other liability arising from the use of such products. No license, express, implied or otherwise, is granted under any patents, copyrights or other intellectual property rights of NEC Electronics or others.
- Descriptions of circuits, software and other related information in this document are provided for illustrative purposes in semiconductor product operation and application examples. The incorporation of these circuits, software and information in the design of a customer's equipment shall be done under the full responsibility of the customer. NEC Electronics assumes no responsibility for any losses incurred by customers or third parties arising from the use of these circuits, software and information.
- While NEC Electronics endeavors to enhance the quality, reliability and safety of NEC Electronics products, customers agree and acknowledge that the possibility of defects thereof cannot be eliminated entirely. To minimize risks of damage to property or injury (including death) to persons arising from defects in NEC Electronics products, customers must incorporate sufficient safety measures in their design, such as redundancy, fire-containment and anti-failure features.
- NEC Electronics products are classified into the following three quality grades: "Standard", "Special" and "Specific".

The "Specific" quality grade applies only to NEC Electronics products developed based on a customer-designated "quality assurance program" for a specific application. The recommended applications of an NEC Electronics product depend on its quality grade, as indicated below. Customers must check the quality grade of each NEC Electronics product before using it in a particular application.

"Standard": Computers, office equipment, communications equipment, test and measurement equipment, audio and visual equipment, home electronic appliances, machine tools, personal electronic equipment and industrial robots.

"Special": Transportation equipment (automobiles, trains, ships, etc.), traffic control systems, anti-disaster systems, anti-crime systems, safety equipment and medical equipment (not specifically designed for life support).

"Specific": Aircraft, aerospace equipment, submersible repeaters, nuclear reactor control systems, life support systems and medical equipment for life support, etc.

The quality grade of NEC Electronics products is "Standard" unless otherwise expressly specified in NEC Electronics data sheets or data books, etc. If customers wish to use NEC Electronics products in applications not intended by NEC Electronics, they must contact an NEC Electronics sales representative in advance to determine NEC Electronics' willingness to support a given application.

(Note)

(1) "NEC Electronics" as used in this statement means NEC Electronics Corporation and also includes its majority-owned subsidiaries.

(2) "NEC Electronics products" means any product developed or manufactured by or for NEC Electronics (as defined above).

M8E 02. 11-1

Caution	GaAs Products	<p>This product uses gallium arsenide (GaAs). GaAs vapor and powder are hazardous to human health if inhaled or ingested, so please observe the following points.</p> <ul style="list-style-type: none">• Follow related laws and ordinances when disposing of the product. If there are no applicable laws and/or ordinances, dispose of the product as recommended below.<ol style="list-style-type: none">1. Commission a disposal company able to (with a license to) collect, transport and dispose of materials that contain arsenic and other such industrial waste materials.2. Exclude the product from general industrial waste and household garbage, and ensure that the product is controlled (as industrial waste subject to special control) up until final disposal.• Do not burn, destroy, cut, crush, or chemically dissolve the product.• Do not lick the product or in any way allow it to enter the mouth.
----------------	---------------	--