

FEATURES

- Single-chip, low power UHF transmitter
- 75 MHz to 1 GHz frequency operation
- Multichannel operation using Frac-N PLL
- 2.3 V to 3.6 V operation
- On-board regulator—stable performance
- Programmable output power:
 - 16 dBm to +14 dBm, 0.4 dB steps
- Data rates: dc to 179.2 kbps
- Low current consumption:
 - 868 MHz, 10 dBm, 21 mA
 - 433 MHz, 10 dBm, 17 mA
 - 315 MHz, 0 dBm, 10 mA
- Programmable low battery voltage indicator

APPLICATIONS

- Low cost wireless data transfer
- Security systems
- RF remote controls
- Wireless metering
- Secure keyless entry

GENERAL DESCRIPTION

The ADF7012 is a low power FSK/GFSK/OOK/GOOK/ASK UHF transmitter designed for short range devices (SRDs). The output power, output channels, deviation frequency, and modulation type are programmable by using four, 32-bit registers.

The fractional-N PLL and VCO with external inductor enable the user to select any frequency in the 75 MHz to 1 GHz band. The fast lock times of the fractional-N PLL make the ADF7012 suitable in fast frequency hopping systems. The fine frequency deviations available and PLL phase noise performance facilitates narrow-band operation.

There are five selectable modulation schemes: binary frequency shift keying (FSK), Gaussian frequency shift keying (GFSK), binary on-off keying (OOK), Gaussian on-off keying (GOOK), and amplitude shift keying (ASK). In the compensation register, the output can be moved in <1 ppm steps so that indirect compensation for frequency error in the crystal reference can be made.

A simple 3-wire interface controls the registers. In power-down, the part has a typical quiescent current of <0.1 μ A.

FUNCTIONAL BLOCK DIAGRAM

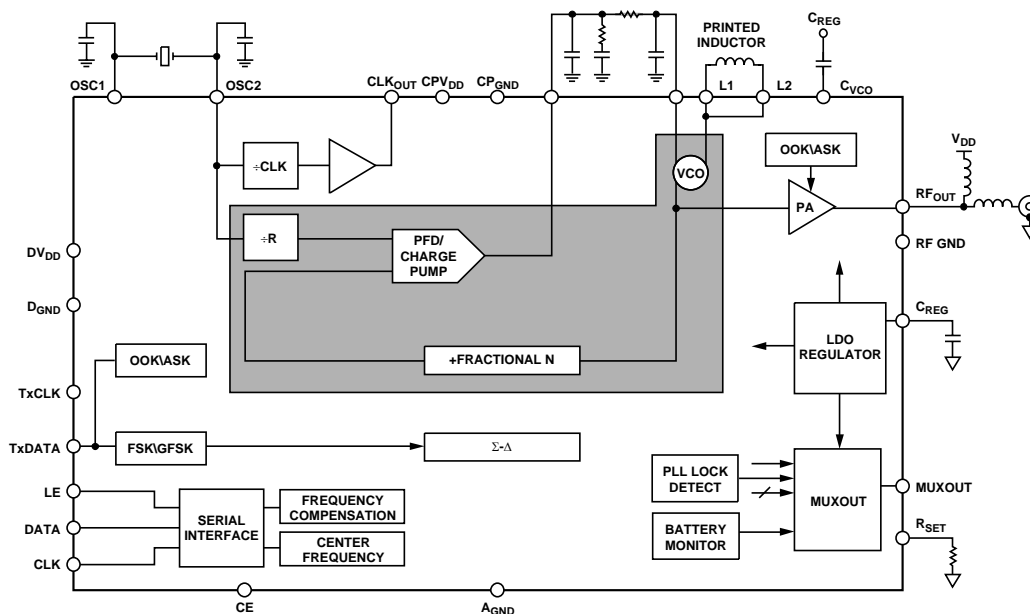

Figure 1.

Rev. 0

Information furnished by Analog Devices is believed to be accurate and reliable. However, no responsibility is assumed by Analog Devices for its use, nor for any infringements of patents or other rights of third parties that may result from its use. Specifications subject to change without notice. No license is granted by implication or otherwise under any patent or patent rights of Analog Devices. Trademarks and registered trademarks are the property of their respective owners.

TABLE OF CONTENTS

| | | | |
|--|----|---|----|
| Specifications..... | 3 | GOOK Modulation | 15 |
| Timing Characteristics..... | 5 | Output Divider | 16 |
| Absolute Maximum Ratings..... | 6 | MUXOUT Modes..... | 16 |
| Transistor Count..... | 6 | Theory of Operation | 17 |
| ESD Caution..... | 6 | Choosing the External Inductor Value..... | 17 |
| Pin Configuration and Function Descriptions..... | 7 | Choosing the Crystal/PFD Value..... | 17 |
| Typical Performance Characteristics | 8 | Tips on Designing the Loop Filter | 17 |
| 315 MHz | 8 | PA Matching..... | 18 |
| 433 MHz | 9 | Transmit Protocol and Coding Considerations | 18 |
| 868 MHz | 10 | Application Examples | 19 |
| 915 MHz | 11 | 315 MHz Operation | 20 |
| Circuit Description..... | 12 | 433 MHz Operation | 21 |
| PLL Operation | 12 | 868 MHz Operation | 22 |
| Crystal Oscillator..... | 12 | 915 MHz Operation | 23 |
| Crystal Compensation Register..... | 12 | Register Descriptions | 24 |
| Clock Out Circuit..... | 12 | R Register..... | 24 |
| Loop Filter | 13 | N-Counter Latch | 25 |
| Voltage-Controlled Oscillator (VCO) | 13 | Modulation Register | 26 |
| Voltage Regulators..... | 13 | Function Register | 27 |
| FSK Modulation..... | 13 | Outline Dimensions | 28 |
| GFSK Modulation | 14 | Ordering Guide | 28 |
| Power Amplifier..... | 14 | | |

REVISION HISTORY

10/04—Revision 0: Initial Version

SPECIFICATIONS

$DV_{DD} = 2.3\text{ V} - 3.6\text{ V}$; $AGND = DGND = 0\text{ V}$; $T_A = T_{MIN}$ to T_{MAX} , unless otherwise noted. Operating temperature range is -40°C to $+85^{\circ}\text{C}$.

Table 1.

| Parameter | B Version | Unit | Conditions/Comments |
|---|-------------------------|-----------------------|--|
| RF OUTPUT CHARACTERISTICS | | | |
| Operating Frequency | 75/1000 | MHz min/max | VCO range adjustable using external inductor; divide-by-2, -4, -8 options may be required |
| Phase Frequency Detector | $F_{RF}/128$ | Hz min | |
| MODULATION PARAMETERS | | | |
| Data Rate FSK/GFSK | 179.2 | kbps | Using 1 MHz loop bandwidth |
| Data Rate ASK/OOK | 64 | Kbps | Based on US FCC 15.247 specifications for ACP; higher data rates are achievable depending on local regulations |
| Deviation FSK/GFSK | $PFD/2^{14}$ | Hz min | For example, 10 MHz PFD – deviation min = $\pm 610\text{ Hz}$ |
| | $511 \times PFD/2^{14}$ | Hz max | For example, 10 MHz PFD – deviation max = $\pm 311.7\text{ kHz}$ |
| GFSK BT | 0.5 | typ | |
| ASK Modulation Depth | 25 | dB max | |
| OOK Feedthrough (PA Off) | -40 | dBm typ | $F_{RF} = F_{VCO}$ |
| | -80 | dBm typ | $F_{RF} = F_{VCO}/2$ |
| POWER AMPLIFIER PARAMETERS | | | |
| Max Power Setting, $DV_{DD} = 3.6\text{ V}$ | 14 | dBm | $F_{RF} = 915\text{ MHz}$, PA is matched into $50\ \Omega$ |
| Max Power Setting, $DV_{DD} = 3.0\text{ V}$ | 13.5 | dBm | $F_{RF} = 915\text{ MHz}$, PA is matched into $50\ \Omega$ |
| Max Power Setting, $DV_{DD} = 2.3\text{ V}$ | 12.5 | dBm | $F_{RF} = 915\text{ MHz}$, PA is matched into $50\ \Omega$ |
| Max Power Setting, $DV_{DD} = 3.6\text{ V}$ | 14.5 | dBm | $F_{RF} = 433\text{ MHz}$, PA is matched into $50\ \Omega$ |
| Max Power Setting, $DV_{DD} = 3.0\text{ V}$ | 14 | dBm | $F_{RF} = 433\text{ MHz}$, PA is matched into $50\ \Omega$ |
| Max Power Setting, $DV_{DD} = 2.3\text{ V}$ | 13 | dBm | $F_{RF} = 433\text{ MHz}$, PA is matched into $50\ \Omega$ |
| PA Programmability | 0.4 | dB typ | PA output = -20 dBm to $+13\text{ dBm}$ |
| POWER SUPPLIES | | | |
| DV_{DD} | 2.3/3.6 | V min/V max | |
| Current Consumption | | | |
| 315 MHz, 0 dBm/5 dBm | 8/14 | mA typ | $DV_{DD} = 3.0\text{ V}$, PA is matched into $50\ \Omega$, $IVCO = \text{min}$ |
| 433 MHz, 0 dBm/10 dBm | 10/18 | mA typ | |
| 868 MHz, 0 dBm/10 dBm/14 dBm | 14/21/32 | mA typ | |
| 915 MHz, 0 dBm/10 dBm/14 dBm | 16/24/35 | mA typ | |
| VCO Current Consumption | 1/8 | mA min/max | VCO current consumption is programmable |
| Crystal Oscillator Current Consumption | 190 | μA typ | |
| Regulator Current Consumption | 280 | μA typ | |
| Power-Down Current | 0.1/1 | μA typ/max | |
| REFERENCE INPUT | | | |
| Crystal Reference Frequency | 3.4/26 | MHz min/max | |
| Single-Ended Reference Frequency | 3.4/26 | MHz min/max | |
| Crystal Power-On Time 3.4 MHz/26 MHz | 1.8/2.2 | ms typ | CE to Clock Enable Valid |
| Single-Ended Input Level | CMOS Levels | | Refer to the LOGIC INPUTS parameter. Applied to OSC 2 – oscillator circuit disabled. |

ADF7012

| Parameter | B Version | Unit | Conditions/Comments |
|--|----------------------|-------------|--|
| PHASE-LOCKED LOOP PARAMETERS | | | |
| VCO Gain | | | |
| 315MHz | 22 | MHz/V typ | VCO divide-by-2 active |
| 433MHz | 24 | MHz/V typ | VCO divide-by-2 active |
| 868MHz | 80 | MHz/V typ | |
| 915MHz | 88 | MHz/V typ | |
| VCO Tuning Range | 0.3/2.0 | V min/max | |
| Spurious (IVCO Min/Max) | -65/-70 | dBc | I_{VCO} is programmable |
| Charge Pump Current | | | |
| Setting [00] | 0.3 | mA typ | Referring to DB[7:6] in Function Register |
| Setting [01] | 0.9 | mA typ | Referring to DB[7:6] in Function Register |
| Setting [10] | 1.5 | mA typ | Referring to DB[7:6] in Function Register |
| Setting [11] | 2.1 | mA typ | Referring to DB[7:6] in Function Register |
| Phase Noise (In band) ¹ | | | |
| 315MHz | -85 | dBc/Hz typ | PFD = 10 MHz, 5 kHz offset, I_{VCO} = 2 mA |
| 433MHz | -83 | dBc/Hz typ | PFD = 10 MHz, 5 kHz offset, I_{VCO} = 2 mA |
| 868MHz | -80 | dBc/Hz typ | PFD = 10 MHz, 5 kHz offset, I_{VCO} = 3 mA |
| 915MHz | -80 | dBc/Hz typ | PFD = 10 MHz, 5 kHz offset, I_{VCO} = 3 mA |
| Phase Noise (Out of Band) ¹ | | | |
| 315MHz | -103 | dBc/Hz typ | PFD = 10 MHz, 1 MHz offset, I_{VCO} = 2 mA |
| 433MHz | -104 | dBc/Hz typ | PFD = 10 MHz, 1 MHz offset, I_{VCO} = 2 mA |
| 868MHz | -115 | dBc/Hz typ | PFD = 10 MHz, 1 MHz offset, I_{VCO} = 3 mA |
| 915MHz | -114 | dBc/Hz typ | PFD = 10 MHz, 1 MHz offset, I_{VCO} = 3 mA |
| Harmonic Content (Second) ² | -20 | dBc typ | $F_{RF} = F_{VCO}$ |
| Harmonic Content (Third) ² | -30 | dBc typ | |
| Harmonic Content (Others) ² | -27 | dBc typ | |
| Harmonic Content (Second) ² | -24 | dBc typ | $F_{RF} = F_{VCO}/N$ (where N = 2, 4, 8) |
| Harmonic Content (Third) ² | -14 | dBc typ | |
| Harmonic Content (Others) ² | -19 | dBc typ | |
| LOGIC INPUTS | | | |
| Input High Voltage, V_{INH} | $0.7 \times DV_{DD}$ | V min | |
| Input Low Voltage, V_{INL} | $0.2 \times DV_{DD}$ | V max | |
| Input Current, I_{INH}/I_{INL} | ± 1 | μA max | |
| Input Capacitance, C_{IN} | 4.0 | pF max | |
| LOGIC OUTPUTS | | | |
| Output High Voltage, V_{OH} | $DV_{DD} - 0.4$ | V min | CMOS output chosen |
| Output High Current, I_{OH} | 500 | μA max | |
| Output Low Voltage, V_{OL} | 0.4 | V max | $I_{OL} = 500 \mu A$ |

¹ Measurements made with $N_{FRAC} = 2048$.

² Measurements made without harmonic filter.

TIMING CHARACTERISTICS

$V_{DD} = 3\text{ V} \pm 10\%$; $AGND = DGND = 0\text{ V}$; $T_A = T_{MIN}$ to T_{MAX} , unless otherwise noted.

Table 2.

| Parameter | Limit at T_{MIN} to T_{MAX} (B Version) | Unit | Test Conditions/Comments |
|-----------|---|--------|--------------------------|
| t_1 | 20 | ns min | LE setup time |
| t_2 | 10 | ns min | Data-to-clock setup time |
| t_3 | 10 | ns min | Data-to-clock hold time |
| t_4 | 25 | ns min | Clock high duration |
| t_5 | 25 | ns min | Clock low duration |
| t_6 | 10 | ns min | Clock -to-LE setup time |
| t_7 | 20 | ns min | LE pulse width |

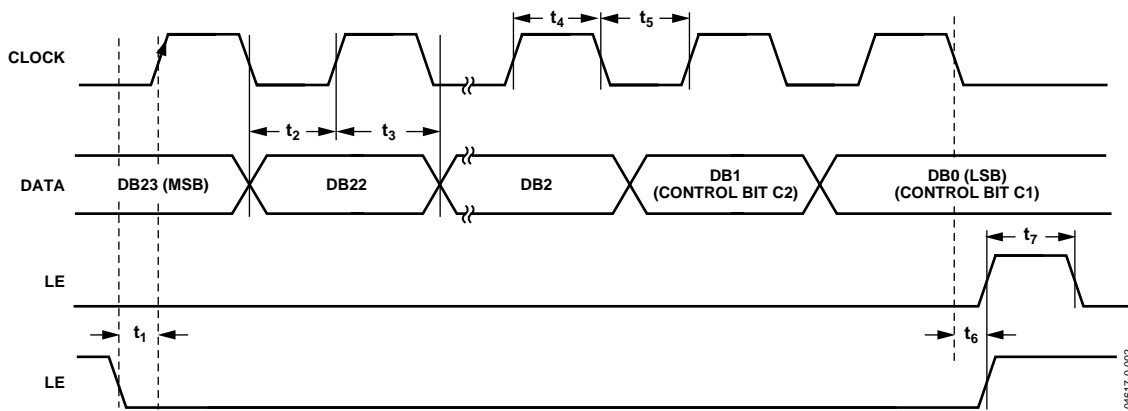

Figure 2. Timing Diagram

ABSOLUTE MAXIMUM RATINGS

T_A = 25°C, unless otherwise noted.

Table 3.

| Parameter | Rating |
|--|------------------------------------|
| DV _{DD} to GND (GND = AGND = DGND = 0 V) | -0.3 V to +3.9 V |
| Digital I/O Voltage to GND | -0.3 V to DV _{DD} + 0.3 V |
| Analog I/O Voltage to GND | -0.3 V to DV _{DD} + 0.3 V |
| Operating Temperature Range | |
| Maximum Junction Temperature | 150°C |
| TSSOP θ _{JA} Thermal Impedance | 150.4°C/W |
| Lead Temperature, Soldering | |
| Vapor Phase (60 sec) | 215°C |
| Infrared (15 sec) | 220°C |

Stresses above those listed under Absolute Maximum Ratings may cause permanent damage to the device. This is a stress rating only; functional operation of the device at these or any other conditions above those listed in the operational sections of this specification is not implied. Exposure to absolute maximum rating conditions for extended periods may affect device reliability.

This device is a high performance RF integrated circuit with an ESD rating of 1 kV and it is ESD sensitive. Proper precautions should be taken for handling and assembly.

TRANSISTOR COUNT

35819 (CMOS)

ESD CAUTION

ESD (electrostatic discharge) sensitive device. Electrostatic charges as high as 4000 V readily accumulate on the human body and test equipment and can discharge without detection. Although this product features proprietary ESD protection circuitry, permanent damage may occur on devices subjected to high energy electrostatic discharges. Therefore, proper ESD precautions are recommended to avoid performance degradation or loss of functionality.



PIN CONFIGURATION AND FUNCTION DESCRIPTIONS

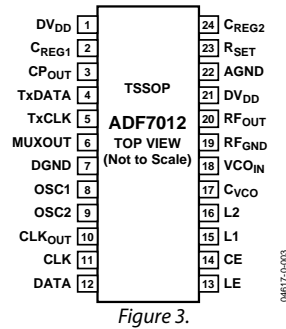

Figure 3.

Table 4. Pin Functional Descriptions

| Pin No. | Mnemonic | Description |
|---------|--------------------|---|
| 1 | DV _{DD} | Positive Supply for the Digital Circuitry. This must be between 2.3 V and 3.6 V. Decoupling capacitors to the analog ground plane should be placed as close as possible to this pin. |
| 2 | C _{REG1} | A 2.2 μF capacitor should be added at C _{REG} to reduce regulator noise and improve stability. A reduced capacitor improves regulator power-on time, but may cause higher spurious noise. |
| 3 | CP _{OUT} | Charge Pump Output. This output generates current pulses that are integrated in the loop filter. The integrated current changes the control voltage on the input to the VCO. |
| 4 | TxDATA | Digital Data to Be Transmitted is inputted on this pin. |
| 5 | TxCLK | GFSK and GOOK only. This clock output is used to synchronize microcontroller data to the TxDATA pin of the ADF7012. The clock is provided at the same frequency as the data rate. The microcontroller updates TxDATA on the falling edge of TxCLK. The rising edge of TxCLK is used to sample TxDATA at the midpoint of each bit. |
| 6 | MUXOUT | Provides the Lock_Detect Signal. This determines if the PLL is locked to the correct frequency and also monitors battery voltage. Other signals include Regulator_Ready, which indicates the status of the serial interface regulator. |
| 7 | DGND | Ground for Digital Section. |
| 8 | OSC1 | The reference crystal should be connected between this pin and OSC2. |
| 9 | OSC2 | The reference crystal should be connected between this pin and OSC1. A TCXO reference may be used, by driving this pin with CMOS levels, and powering down the crystal oscillator bit in software. |
| 10 | CLK _{OUT} | A divided-down version of the crystal reference with output driver. The digital clock output may be used to drive several other CMOS inputs, such as a microcontroller clock. The output has a 50:50 mark-space ratio. |
| 11 | CLK | Serial Clock Input. This serial clock is used to clock in the serial data to the registers. The data is latched into the 32-bit shift register on the CLK rising edge. This input is a high impedance CMOS input. |
| 12 | DATA | Serial Data Input. The serial data is loaded MSB first with the two LSBs being the control bits. This is a high impedance CMOS input. |
| 13 | LE | Load Enable, CMOS Input. When LE goes high, the data stored in the shift registers is loaded into one of the four latches, the latch being selected using the control bits. |
| 14 | CE | Chip Enable. Bringing CE low puts the ADF7012 into complete power-down, drawing < 1 uA. Register values are lost when CE is low and the part must be reprogrammed once CE is brought high. |
| 15 | L1 | Connected to external printed or discrete inductor. See Choosing the External Inductor Value for advice on the value of the inductor to be connected between L1 and L2. |
| 16 | L2 | Connected to external printed or discrete inductor. |
| 17 | C _{VCO} | A 220 nF capacitor should be tied between the C _{VCO} and C _{REG2} pins. This line should run underneath the ADF7012. This capacitor is necessary to ensure stable VCO operation. |
| 18 | VCO _{IN} | The tuning voltage on this pin determines the output frequency of the voltage controlled oscillator (VCO). The higher the tuning voltage, the higher the output frequency. |
| 19 | RF _{GND} | Ground for Output Stage of Transmitter. |
| 20 | RF _{OUT} | The modulated signal is available at this pin. Output power levels are from -16 dBm to +12 dBm. The output should be impedance matched using suitable components to the desired load. See the PA Matching section. |
| 21 | DV _{DD} | Voltage supply for VCO and PA section. This should have the same supply as DV _{DD} Pin 1, and should be between 2.3 V and 3.6 V. Place decoupling capacitors to the analog ground plane as close as possible to this pin. |
| 22 | AGND | Ground Pin for the RF Analog Circuitry. |
| 23 | R _{SET} | External Resistor to set charge pump current and some internal bias currents. Use 3.6 kV as default. |
| 24 | C _{REG2} | Add a 470 nF capacitor at C _{REG} to reduce regulator noise and improve stability. A reduced capacitor improves regulator power-on time and phase noise, but may have stability issues over the supply and temperature. |

TYPICAL PERFORMANCE CHARACTERISTICS

315 MHz

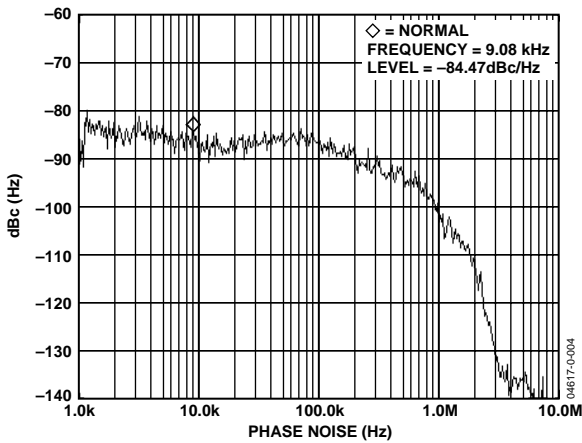

Figure 4. Phase Noise Response— $DV_{DD} = 3.0 V$, $I_{CP} = 0.86 mA$, $I_{VCO} = 2.0 mA$, $F_{OUT} = 315 MHz$, $PFD = 3.6864 MHz$, $PA Bias = 5.5 mA$

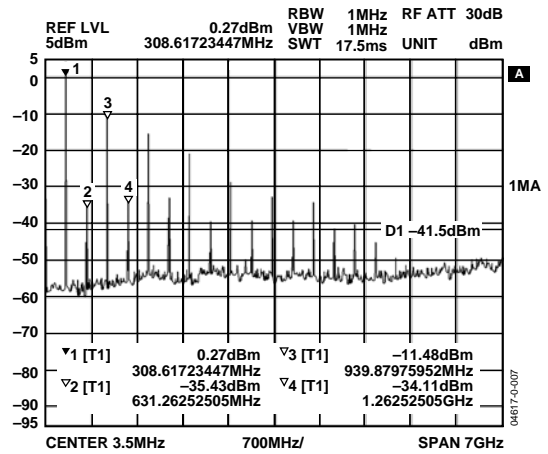

Figure 7. Harmonic Response, R_{FOUT} Matched to 50Ω , No Filter

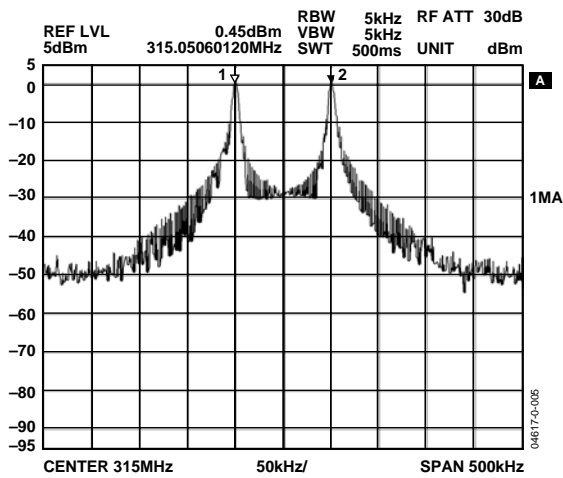

Figure 5. FSK Modulation, Power = 0 dBm, Data Rate = 1 kbps, $F_{DEVIATION} = \pm 50 kHz$

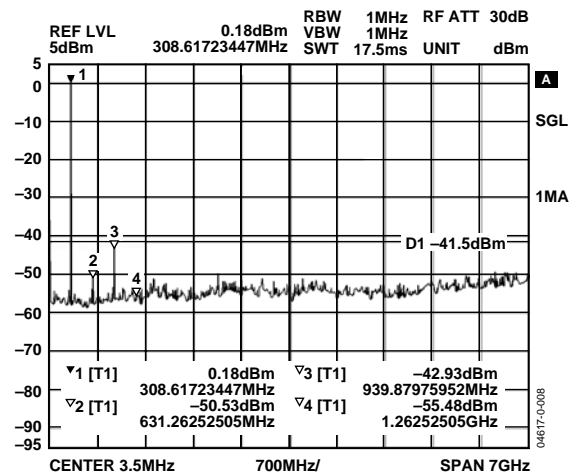

Figure 8. Harmonic Response, Fifth-Order Butterworth Filter

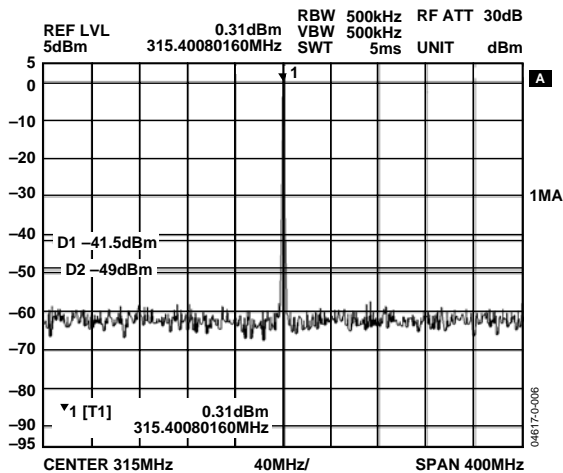

Figure 6. Spurious Components—Meets FCC Specs

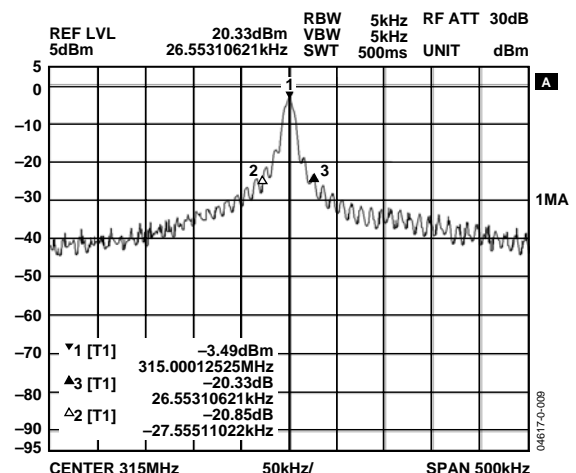

Figure 9. OOK Modulation, Power = 0 dBm, Data Rate = 10 kbps

433 MHz

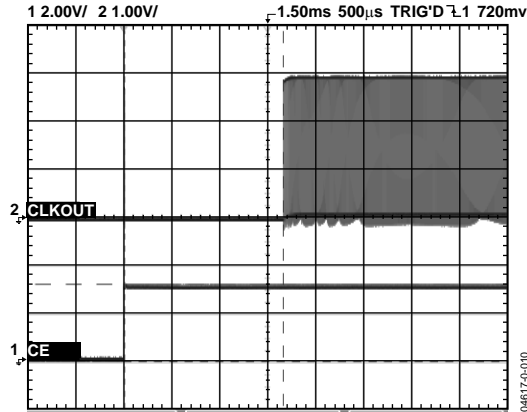

Figure 10. Crystal Power-On Time, 4 MHz, Time = 1.6 ms

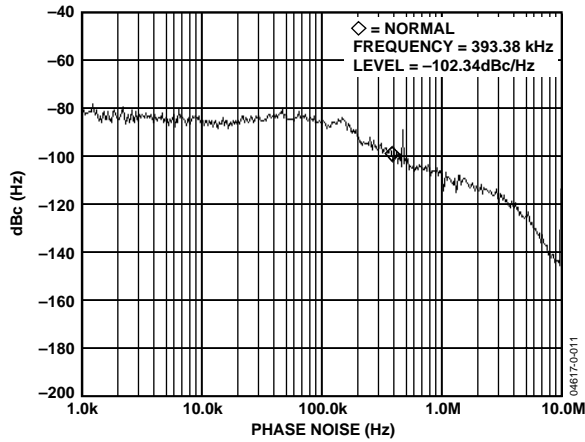

Figure 11. Phase Noise Response— $I_{CP} = 2.0 \text{ mA}$, $I_{VCO} = 2.0 \text{ mA}$, $R_{FOUT} = 433.92 \text{ MHz}$, $PFD = 4 \text{ MHz}$, $PA \text{ Bias} = 5.5 \text{ mA}$

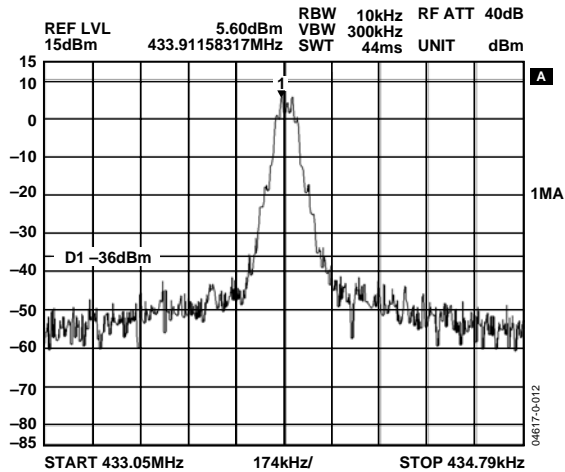

Figure 12. FSK Modulation, Power = 10 dBm, Data Rate = 38.4 kbps, $F_{DEVIATION} = \pm 19.28 \text{ kHz}$

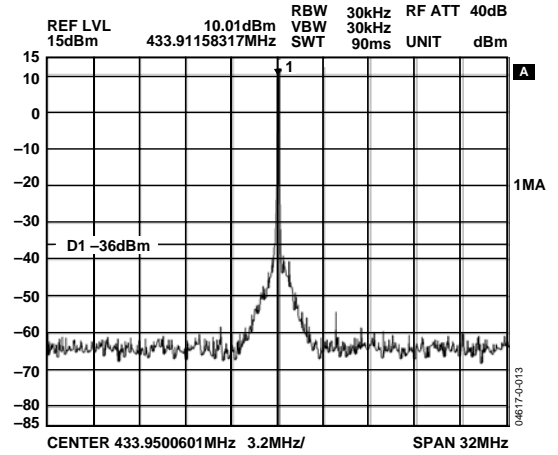

Figure 13. Spurious Components—Meets ETSI Specs

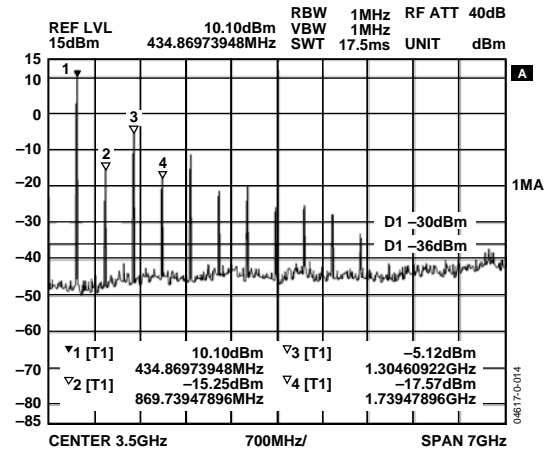

Figure 14. Harmonic Response, R_{FOUT} Matched to 50 Ω , No Filter

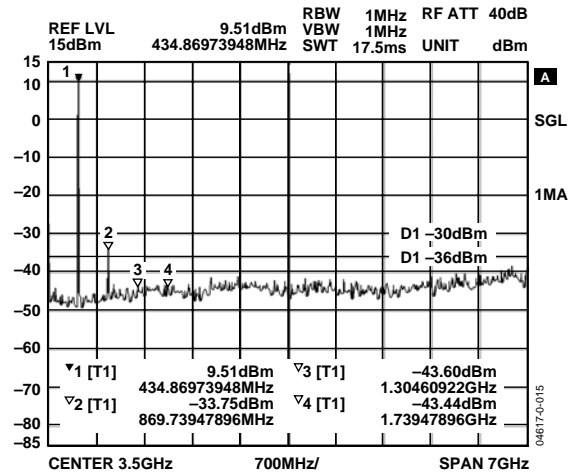

Figure 15. Harmonic Response, Fifth-Order Butterworth Filter

868 MHz

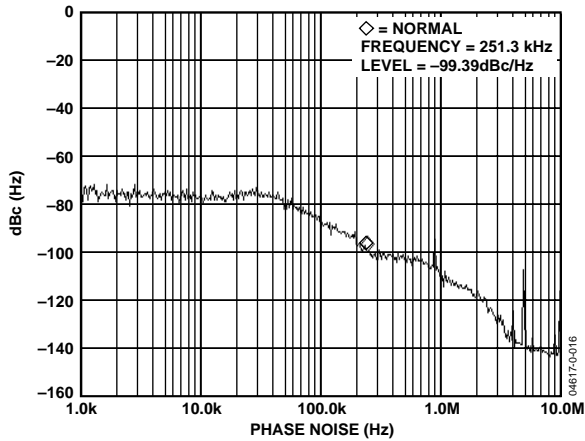

Figure 16. Phase Noise Response— $I_{CP} = 2.5$ mA, $I_{VCO} = 1.44$ mA, $RF_{OUT} = 868.95$ MHz, PFD = 4.9152 MHz—Power = 12.5 dBm, PA Bias = Max

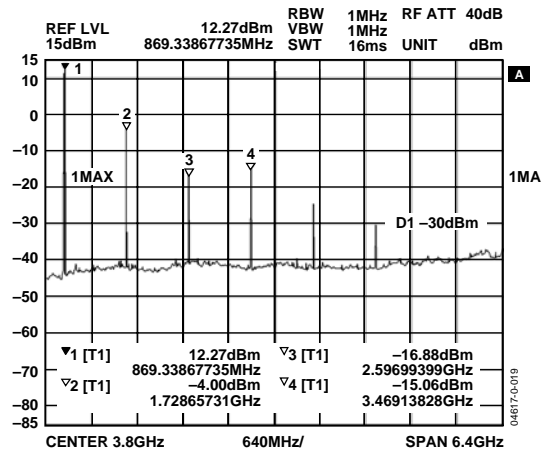

Figure 19. Harmonic Response, RF_{OUT} Matched to 50 Ω , No Filter

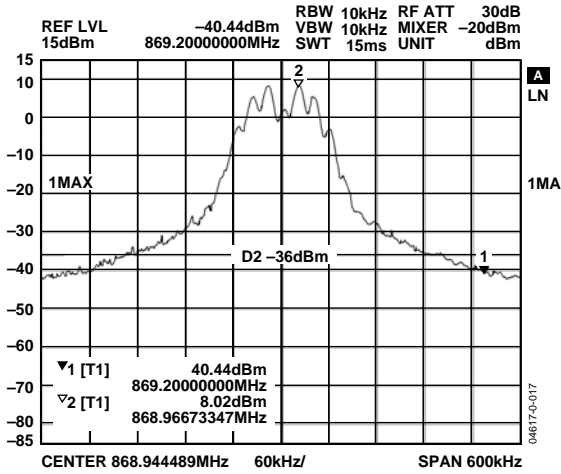

Figure 17. FSK Modulation, Power = 12.5 dBm, Data Rate = 38.4 kbps, $F_{DEVIATION} = \pm 19.2$ kHz

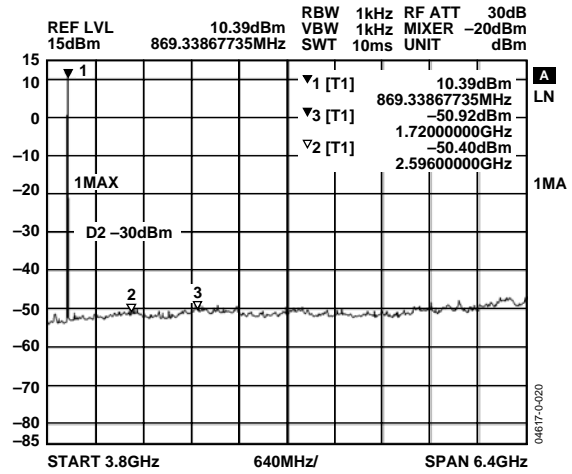

Figure 20. Harmonic Response, Fifth-Order Chebyshev Filter

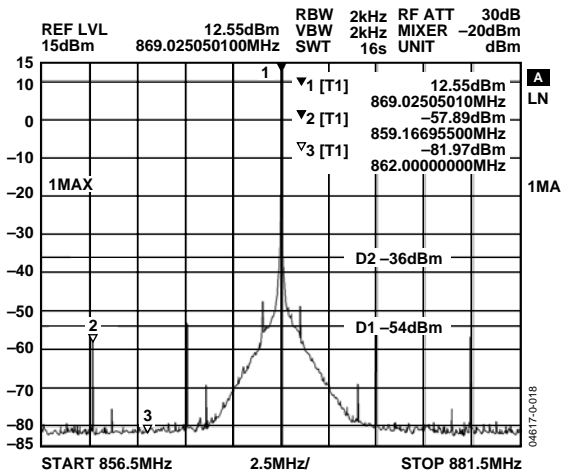

Figure 18. Spurious Components—Meets ETSI Specs

915 MHz

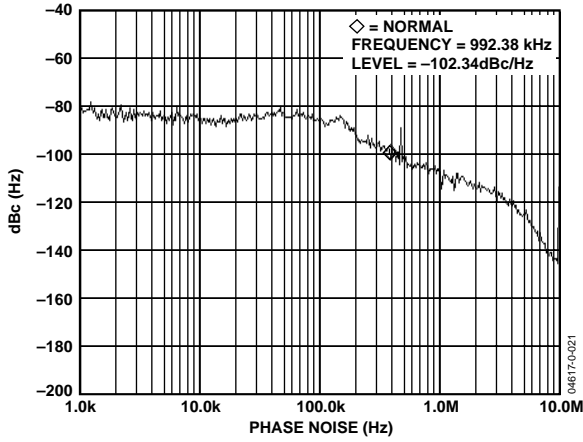

Figure 21. Phase Noise Response— $I_{CP} = 1.44 \text{ mA}$, $I_{VCO} = 3.0 \text{ mA}$, $R_{FOUT} = 915.2 \text{ MHz}$, $PFD = 10 \text{ MHz}$, $\text{Power} = 10 \text{ dBm}$, $\text{PA Bias} = 5.5 \text{ mA}$

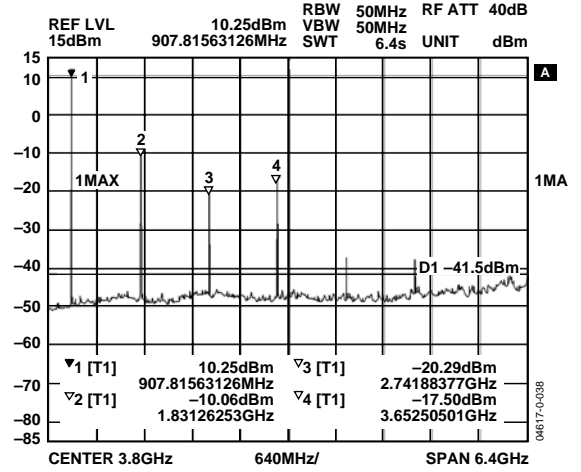

Figure 24. Harmonic Response, R_{FOUT} Matched to 50Ω , No Filter

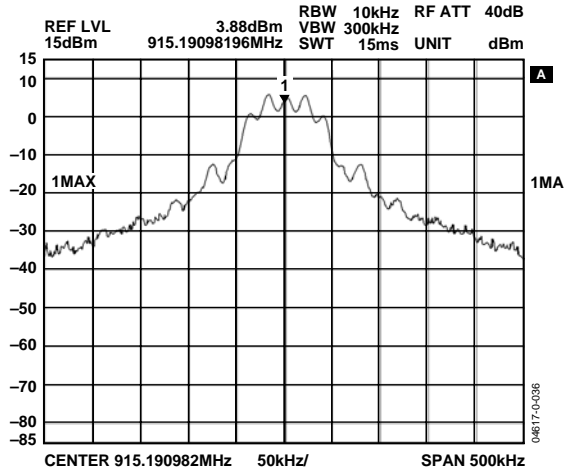

Figure 22. FSK Modulation, $\text{Power} = 10 \text{ dBm}$, $\text{Data Rate} = 38.4 \text{ kbps}$, $F_{\text{deviation}} = \pm 19.2 \text{ kHz}$

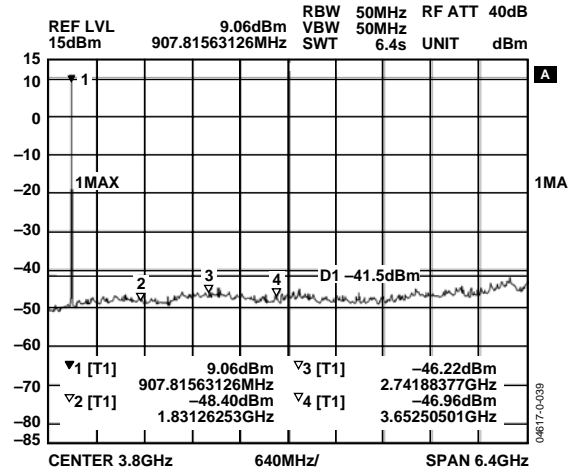

Figure 25. Harmonic Response, Fifth-Order Chebyshev Filter

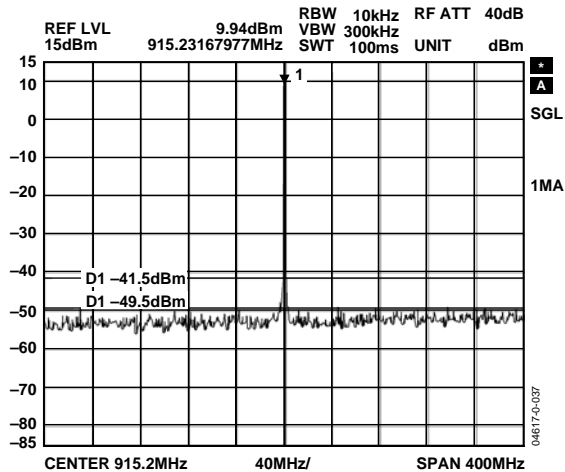

Figure 23. Spurious Components—Meets FCC Specs

CIRCUIT DESCRIPTION

PLL OPERATION

A fractional-N PLL allows multiple output frequencies to be generated from a single-reference oscillator (usually a crystal) simply by changing the programmable N value found in the N register. At the phase frequency detector (PFD), the reference is compared to a divided-down version of the output frequency (VCO/N). If VCO/N is too low a frequency, typically the output frequency is lower than desired, and the PFD and charge-pump combination sends additional current pulses to the loop filter. This increases the voltage applied to the input of the VCO. Because the VCO of the ADF7012 has a positive frequency vs. voltage characteristic, any increase in the Vtune voltage applied to the VCO input increases the output frequency at a rate of kV, the tuning sensitivity of the VCO (MHz/V). At each interval of 1/PFD seconds, a comparison is made at the PFD until the PFD and charge pump eventually force a state of equilibrium in the PLL where PFD frequency = VCO/N. At this point, the PLL can be described as locked.

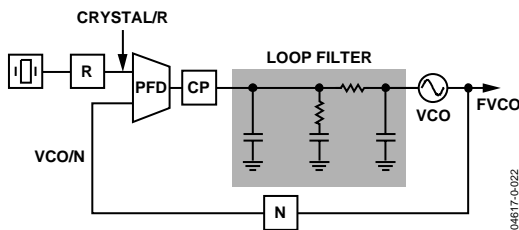

Figure 26.

$$F_{OUT} = \frac{F_{CRYSTAL} \times N}{R} = F_{PFD} \times N \quad (1)$$

For a Fractional N PLL

$$F_{OUT} = F_{PFD} \times \left(N_{INT} + \frac{N_{FRAC}}{2^{12}} \right) \quad (2)$$

where N_{FRAC} can be bits M1 to M12 in the fractional N register.

CRYSTAL OSCILLATOR

The on-board crystal oscillator circuitry (Figure 27) allows an inexpensive quartz crystal to be used as the PLL reference. The oscillator circuit is enabled by setting XOEB low. It is enabled by default on power-up and is disabled by bringing CE low. Errors in the crystal can be corrected using the error correction register within the R register.

A single-ended reference may be used instead of a crystal, by applying a square wave to the OSC2 pin, with XOEB set high.

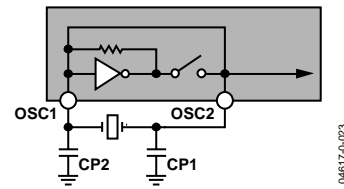

Figure 27.

Two parallel resonant capacitors are required for oscillation at the correct frequency—the value of these depend on the crystal specification. They should be chosen so that the series value of capacitance added to the PCB track capacitance adds to give the load capacitance of the crystal, usually 20 pF. Track capacitance values vary between 2 pF to 5 pF, depending on board layout.

Where possible, to ensure stable frequency operation over all conditions, capacitors should be chosen so that they have a very low temperature coefficient and/or opposite temperature coefficients

CRYSTAL COMPENSATION REGISTER

The ADF7012 features a 15-bit fixed modulus, which allows the output frequency to be adjusted in steps of $F_{PFD}/15$. This fine resolution can be used to easily compensate for initial error and temperature drift in the reference crystal.

$$F_{ADJUST} = F_{STEP} \times FEC \quad (3)$$

where $F_{STEP} = F_{PFD}/215$ and $FEC = \text{Bits F1 to F11 in the R Register}$. Note that the notation is twos complement, so F11 represents the sign of the FEC number.

Example

$F_{PFD} = 10 \text{ MHz}$
 $F_{ADJUST} = -11 \text{ kHz}$
 $F_{STEP} = 10 \text{ MHz}/2^{15} = 305.176 \text{ Hz}$
 $FEC = -11 \text{ kHz}/305.17 \text{ Hz} = -36 = -(00000100100) = 11111011100 = 0x7DC$

CLOCK OUT CIRCUIT

The clock out circuit takes the reference clock signal from the oscillator section above and supplies a divided-down 50:50 mark-space signal to the CLK_{OUT} pin. An even divide from 2 to 30 is available. This divide is set by the $DB[19:22]$ in the R register. On power-up, the CLK_{OUT} defaults to divide by 16.

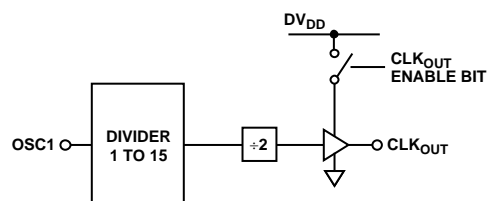

Figure 28.

The output buffer to CLK_{OUT} is enabled by setting Bit DB4 in the function register high. On power-up, this bit is set high. The output buffer can drive up to a 20 pF load with a 10% rise time at 4.8 MHz. Faster edges can result in some spurious feedthrough to the output. A small series resistor (50 Ω) can be used to slow the clock edges to reduce these spurs at F_{CLK}.

LOOP FILTER

The loop filter integrates the current pulses from the charge pump to form a voltage that tunes the output of the VCO to the desired frequency. It also attenuates spurious levels generated by the PLL. A typical loop filter design is shown in Figure 29.

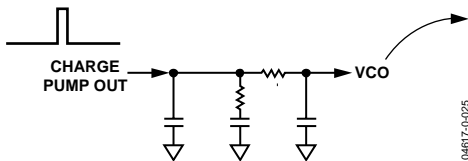

Figure 29.

In FSK, the loop should be designed so that the loop bandwidth (LBW) is a minimum of two to three times the data rate. Widening the LBW excessively reduces the time spent jumping between frequencies, but results in reduced spurious attenuation. See the section Tips on Designing the Loop Filter.

For OOK/ASK systems, a wider loop bandwidth than for FSK systems is desirable. The sudden large transition between two power levels results in VCO pulling (VCO temporarily goes to incorrect frequency) and can cause a wider output spectrum. By widening the loop bandwidth a minimum of $10 \times$ data rate, VCO pulling is minimized because the loop settles quickly back to the correct frequency. The free design tool ADIsimPLL™ can be used to design loop filters for the ADI family of transmitters.

VOLTAGE-CONTROLLED OSCILLATOR (VCO)

The ADF7012 features an on-chip VCO with an external tank inductor, which is used to set the frequency range. The center frequency of oscillation is governed by the internal varactor capacitance and that of the external inductor combined with the bond-wire inductance. An approximation for this is given in the Equation 4. For a more accurate selection of the inductor, see the section Choosing the External Inductor Value.

$$F_{VCO} = \frac{1}{2\pi\sqrt{(L_{INT} + L_{EXT}) \times (C_{VAR} + C_{FIXED})}} \quad (4)$$

The varactor capacitance can be adjusted in software to increase the effective VCO range by writing to bits VA1 and VA2 in the R register. Under typical conditions, setting VA1 and VA2 high increases the center frequency by reducing the varactor capacitance by approximately 1.3 pF.

Figure 32 shows the VCO gain over temperature and frequency. VCO gain is important in determining the loop filter design—predictable changes in VCO gain resulting in a change in the loop filter bandwidth can be offset by changing the charge-pump current in software.

VCO Bias Current

VCO bias current may be adjusted using bits VB1 to VB4 in the function register. Additional bias current will reduce spurious levels, but increase overall current consumption in the part. A bias value of 0x5 should ensure oscillation at most frequencies and supplies. Settings 0x0, 0xE, and 0xF are not recommended. Setting 0x3 and Setting 0x4 are recommended under most conditions. Improved phase noise can be achieved for lower bias currents.

VOLTAGE REGULATORS

There are two band gap voltage regulators on the ADF7012 providing a stable 2.25 V internal supply: a 2.2 μF capacitor (X5R, NP0) to ground at C_{REG1} and a 470 nF capacitor at C_{REG2} should be used to ensure stability. The internal reference ensures consistent performance over all supplies and reduces the current consumption of each of the blocks.

The combination of regulators, band gap reference, and biasing typically consume 1.045 mA at 3.0 V and can be powered down by bringing the CE line low. The serial interface is supplied by Regulator 1, so powering down the CE line causes the contents of the registers to be lost. The CE line must be high and the regulators must be fully powered on to write to the serial interface. Regulator power-on time is typically 100 μs and should be taken into account when writing to the ADF7012 after power-up. Alternatively, regulator status may be monitored at the MUXOUT pin once CE has been asserted, because MUXOUT defaults to the regulator ready signal. Once Regulator_ready is high, the regulator is powered up and the serial interface is active.

FSK MODULATION

FSK modulation is performed internally in the PLL loop by switching the value of the N register based on the status of the TxDATA line. The TxDATA line is sampled at each cycle of the PFD block (every 1/F_{PFD} seconds). When TxDATA makes a low-to-high transition, an N value representing the deviation frequency is added to the N value representing the center frequency. Immediately the loop begins to lock to the new frequency of F_{CENTER} + F_{DEVIATION}. Conversely, when TxDATA makes a high-to-low transition, the N value representing the deviation is subtracted from the PLL N value representing the center frequency and the loop transitions to F_{CENTER} - F_{DEVIATION}.

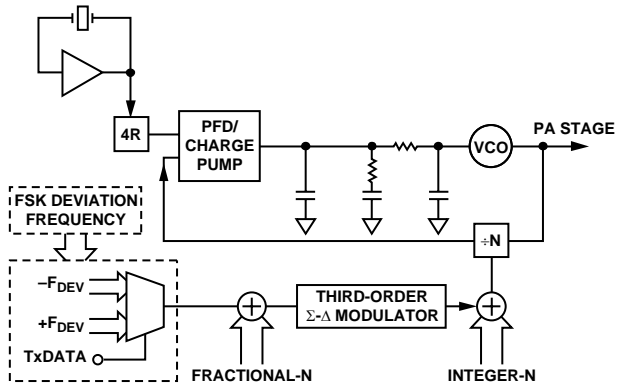

Figure 30.

The deviation from the center frequency is set using bits D1 to D9 in the modulation register. The frequency deviation may be set in steps of

$$F_{STEP}(\text{Hz}) = \frac{F_{PFD}}{2^{14}} \quad (5)$$

The deviation frequency is therefore

$$F_{DEVIATION}(\text{Hz}) = \frac{F_{PFD} \times \text{ModulationNumber}}{2^{14}} \quad (6)$$

where *ModulationNumber* is set by bits D1 to D9.

The maximum data rate is a function of the PLL lock time (and the requirement on FSK spectrum). Because the PLL lock time is reduced by increasing the loop-filter bandwidth, highest data rates can be achieved for the wider loop filter bandwidths. The absolute maximum limit on loop filter bandwidth to ensure stability for a fractional-N PLL is $F_{PFD}/7$. For a 20 MHz PFD frequency, the loop bandwidth could be as high as 2.85 MHz. FSK modulation is selected by setting bits S1 and S2 in the modulation register low.

GFSK MODULATION

Gaussian Frequency Shift Keying, or GFSK, represents a filtered form of frequency shift keying. The data to be modulated to RF is prefiltered digitally using an finite impulse response filter (FIR). The filtered data is then used to modulate the sigma-delta fractional-N to generate spectrally-efficient FSK.

FSK consists of a series of sharp transitions in frequency as the data is switched from one level to an other. The sharp switching generates higher frequency components at the output, resulting in a wider output spectrum.

With GFSK, the sharp transitions are replaced with up to 128 smaller steps. The result is a gradual change in frequency. As a result, the higher frequency components are reduced and the spectrum occupied is reduced significantly. GFSK does require some additional design work as the data is only sampled once per bit, and so the choice of crystal is important to ensure the correct sampling clock is generated.

For GFSK and GOOK, the incoming bit stream to be transmitted needs to be synchronized with an on-chip sampling clock which provides one sample per bit to the Gaussian FIR filter. To facilitate this, the sampling clock is routed to the TxCLK pin where data is fetched from the host microcontroller or microprocessor on the falling edge of TxCLK, and the data is sampled at the midpoint of each bit on TxCLK's rising edge. Inserting external RC LPFs on TxDATA and TxCLK lines creates smoother edge transitions and improves spurious performance. As an example, suitable components would be a 1 kV resistor and 10 nF capacitor for a data rate of 5 kbps.

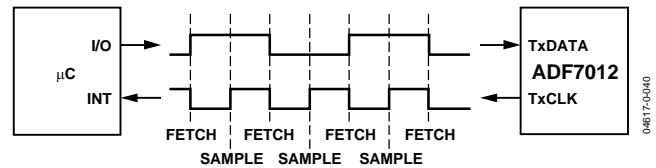

Figure 31. TxCLK/TxDATA Synchronization.

The number of steps between symbol '0' and symbol '1' is determined by the setting for the index counter.

The GFSK deviation is set up as

$$GFSK_{DEVIATION}(\text{Hz}) = \frac{F_{PFD} \times 2^m}{2^{12}} \quad (7)$$

where *m* is the mod control (Bits MC1 to MC3 in the modulation register).

The GFSK sampling clock samples data at the data rate:

$$\text{DataRate}(\text{bps}) = \frac{F_{PFD}}{\text{DividerFactor} \times \text{IndexCounter}} \quad (8)$$

where *DividerFactor* can be bits D1 to D7, and *IndexCounter* can be bits IC1 and IC2 in the modulation register.

POWER AMPLIFIER

The output stage is based on a Class E amplifier design, with an open drain output switched by the VCO signal. The output control consists of six current mirrors operating as a programmable current source.

To achieve maximum voltage swing, the RF_{OUT} pin needs to be biased at DV_{DD}. A single pull-up inductor to DV_{DD} ensures a current supply to the output stage, PA biased to DV_{DD} volts, and with the correct choice of value transforms the impedance.

The output power can be adjusted by changing the value of bits P1 to P6. Typically, this is P1 to P6 output -20dBm at 0x0, and 13 dBm at 0x7E at 868MHz, with the optimum matching network.

The nonlinear characteristic of the output stage results in an output spectrum containing harmonics of the fundamental, especially the third and fifth. To meet local regulations, a low-pass filter usually is required to filter these harmonics.

The output stage can be powered down by setting Bit PD2 in the function register low.

GOOK MODULATION

Gaussian on-off keying (GOOK) represents a prefiltered form of OOK modulation. The usually sharp symbol transitions are replaced with smooth Gaussian-filtered transitions with the result being a reduction in frequency pulling of the VCO. Frequency pulling of the VCO in OOK mode can lead to a wider than desired bandwidth, especially if it is not possible to increase the loop filter bandwidth to > 300kHz.

The GOOK sampling clock samples data at the data rate:

$$DataRate(bps) = \frac{F_{PFD}}{DividerFactor \times IndexCounter} \quad (9)$$

Bits D1 to D6 represent the output power for the system for a positive data bit. *Divider Factor* = 0x3F represents the maximum possible deviation from PA at minimum to PA at maximum output. An index counter setting of 128 is recommended.

Figure 32 shows the step response of the Gaussian FIR filter. An index counter of 16 is demonstrated for simplicity. While the pre-filter data would switch the PA directly from off to on with a low-to-high data transition, the filtered data gradually increases the PA output in discrete steps. This has the effect of making the output spectrum more compact.

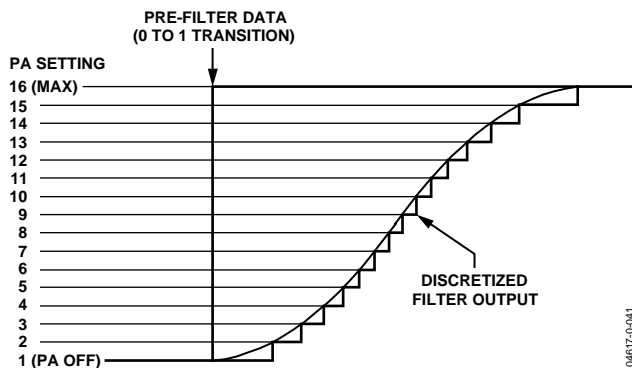

Figure 32. Varying PA Output for GOOK (Index Counter = 16).

As is the case with GFSK, GOOK requires the bit stream applied at TxDATA to be synchronized with the sampling clock, TxCLK (see the GFSK Modulation section).

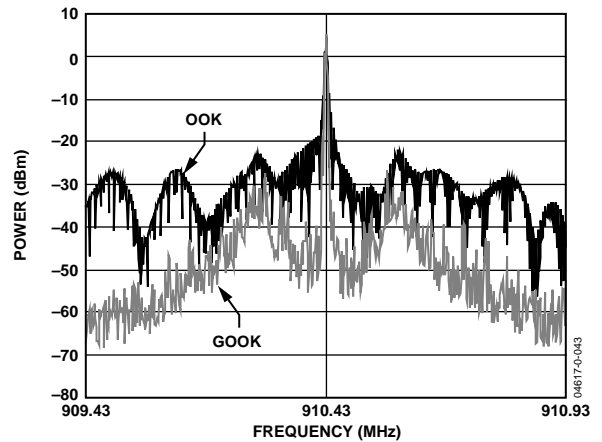

Figure 33. GOOK vs. OOK Frequency Spectra (Narrow-Band Measurement)

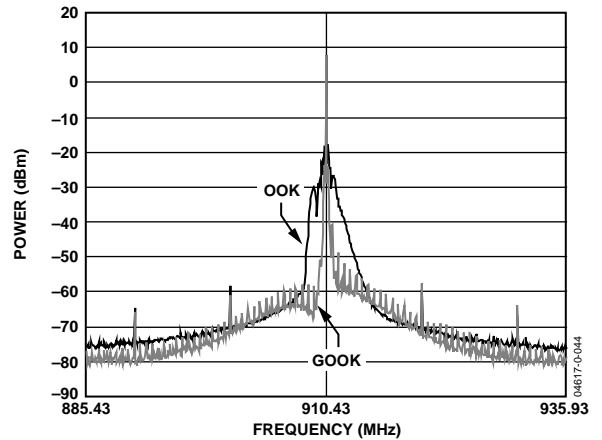

Figure 34. GOOK vs. OOK Frequency Spectra (Wideband Measurement)

OUTPUT DIVIDER

An output divider is a programmable divider following the VCO in the PLL loop. It is useful when using the ADF7012 to generate frequencies of < 500 MHz.

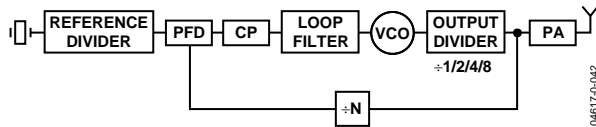

Figure 35. Output Divider Location in PLL.

The output divider may be used to reduce feedthrough of the VCO by amplifying only the VCO/2 component, restricting the VCO feedthrough to leakage.

Because the divider is in loop, the N register values should be set up according to the usual formula. However, the VCO gain (K_v) should be scaled according to the divider setting, as shown in the following example.

$F_{out} = 433 \text{ MHz}$, $F_{vco} = 866 \text{ MHz}$, $K_v @ 868 \text{ MHz} = 60 \text{ MHz/V}$

Therefore, K_v for loop filter design = 30 MHz/V .

The divider value is set in the R register.

Table 5.

| OD1 | OD2 | Divider Status |
|-----|-----|----------------|
| 0 | 0 | Divider off |
| 0 | 1 | Divide by 2 |
| 1 | 0 | Divide by 4 |
| 1 | 1 | Divide by 8 |

MUXOUT MODES

The MUXOUT pin allows the user access to various internal signals in the transmitter, and provides information on the PLL lock status, the regulator, and the battery voltage. The MUXOUT is accessed by programming Bits M1 to M4 in the function register and observing the signal at the MUXOUT pin.

Battery Voltage Read back

By setting MUXOUT to 1010 to 1101, the battery voltage can be estimated. The battery measuring circuit features a voltage divider and a comparator where the divided-down supply voltage is compared to the regulator voltage.

Table 6.

| MUXOUT | MUXOUT High | MUXOUT Low |
|--------|----------------------------|----------------------------|
| 1010 | $DV_{DD} > 3.25 \text{ V}$ | $DV_{DD} < 3.25 \text{ V}$ |
| 1011 | $DV_{DD} > 3.0 \text{ V}$ | $DV_{DD} < 3.0 \text{ V}$ |
| 1100 | $DV_{DD} > 2.75 \text{ V}$ | $DV_{DD} < 2.75 \text{ V}$ |
| 1101 | $DV_{DD} > 2.35 \text{ V}$ | $DV_{DD} < 2.35 \text{ V}$ |

The accuracy of the measurement is limited by the accuracy of the regulator voltage and also the internal resistor tolerances.

Regulator Ready

The regulator has a power-up time, dependant on process and the external capacitor. The regulator ready signal indicates that the regulator is fully powered, and that the serial interface is active. This is the default setting on power-up at MUXOUT.

Digital Lock Detect

Digital lock detect indicates that the status of the PLL loop. The PLL loop takes time to settle on power-up and when the frequency of the loop is changed by changing the N value. When lock detect is high, the PFD has counted a number of consecutive cycles where the phase error is < 15 ns. The lock detect precision bit in the function register determines whether this is 3 cycles (LDP = 0), or 5 cycles (LDP=1). It is recommended that LDP be set to 1. The lock detect is not completely accurate and goes high before the output has settled to exactly the correct frequency. In general, add 50% to the indicated lock time to obtain lock time to within 1 kHz. The lock detect signal can be used to decide when the power amplifier (PA) should be enabled.

R Divider

MUXOUT provides the output of the R divider. This is a narrow pulsed digital signal at frequency F_{PFD} . This signal may be used to check the operation of the crystal circuit and the R divider. R divider/2 is a buffered version of this signal at $F_{PFD}/2$.

THEORY OF OPERATION

CHOOSING THE EXTERNAL INDUCTOR VALUE

The ADF7012 allows operation at many different frequencies by choosing the external VCO inductor to give the correct output frequency. Figure 36 shows both the minimum and maximum frequency vs. the inductor value. These are measurements based on 0603 CS type inductors from Coilcraft, and are intended as guidelines in choosing the inductor because board layout and inductor type varies between applications.

The inductor value should be chosen so it is between the minimum and maximum value.

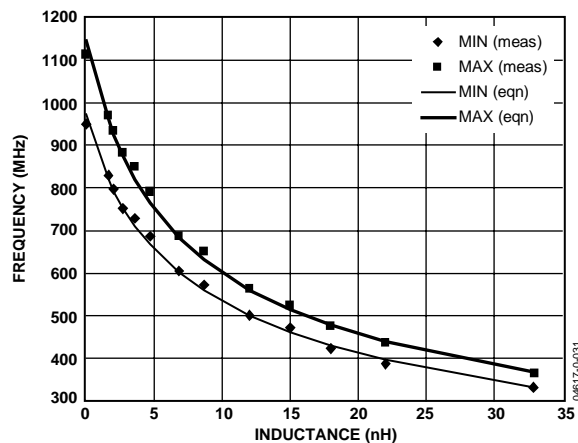

Figure 36. Output Frequency vs. External Inductor Value
I_{bias} = 2.0 mA.

For frequencies between 270 MHz and 550 MHz, it is recommended to operate the VCO at twice the desired output frequency and use the divide-by-2 option. This ensures reliable operation over temperature and supply.

For frequencies between 130 MHz and 270 MHz, it is recommended to operate the VCO at four times the desired output frequency and use the divide-by-4 option.

For frequencies below 130 MHz, it is best to use the divide-by-8 option. It is not necessary to use the VCO divider for frequencies above 550 MHz.

ADIsimPLL is a PLL design tool which can perform the frequency calculations for the ADF7012, and is available at www.analog.com/pll.

CHOOSING THE CRYSTAL/PFD VALUE

The choice of crystal value is an important one. The PFD frequency must be the same as the crystal value or an integer division of it. The PFD determines the phase noise, spurious levels and location, deviation frequency, and the data rate in the case of GFSK. The following sections describe some factors that should be considered when choosing the crystal value.

Standard Crystal Values

Standard crystal values are 3.6864 MHz, 4 MHz, 4.096 MHz, 4.9152 MHz, 7.3728 MHz, 9.8304 MHz, 10 MHz, 11.0592 MHz, 12 MHz, and 14.4792 MHz. Crystals with these values are usually available in stock and cost less than crystals with nonstandard values.

Reference Spurious Levels

Reference spurious levels (spurs) occur at multiples of the PFD frequency. The reference spur closest to the carrier is usually highest with the spur further out being attenuated by the loop filter. The level of reference spur is lower for lower PFD frequencies. In designs with high output power where spurious levels are the main concern, a lower PFD frequency (<5 MHz) may be desirable.

Beat Note Spurs

These are spurs occurring for very small or very large values in the fractional register. These are quickly attenuated by the loop filter. Selection of the PFD therefore determines their location, and ensures that they have negligible effect on the transmitter spectrum.

Phase Noise

The phase noise of a frequency synthesizer improves by 3dB for every doubling of the PFD frequency. Because ACP is related to the phase noise, the PFD may be increased to reduce the ACP in the system. PFD frequencies of < 5MHz typically deliver sufficient phase noise performance for most systems.

Deviation Frequency

The deviation frequency is adjustable in steps of

$$F_{STEP}(Hz) = \frac{F_{PFD}}{2^{14}} \quad (10)$$

To get the exact deviation frequency required, ensure F_{STEP} is a factor of the desired deviation.

TIPS ON DESIGNING THE LOOP FILTER

The loop filter design is crucial in ensuring stable operation of the transmitter, meeting Adjacent Channel Power (ACP) specifications, and meeting spurious requirements for the relevant regulations. ADIsimPLL is a free tool available to aid the design of loop filters. The user enters the desired frequency range, the reference crystal and PFD values, and the desired loop bandwidth. ADIsimPLL gives a good starting point for the filter, and the filter can be further optimized based on the criteria below.

ADF7012

Setting Tuning Sensitivity Value

The tuning sensitivity or k_V is usually denoted in MHz/V and is required for the loop filter design. It refers to the amount that a change of a volt in the voltage applied to VCO_{IN} pin, changes the output frequency. Typical data for the ADF7012 over a frequency range is shown.

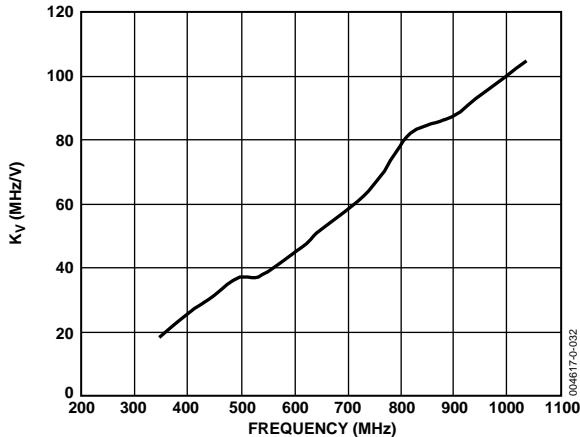

Figure 37. k_V vs. VCO Frequency

Charge-Pump Current

The charge-pump current allows the loop filter bandwidth to be changed using the registers. The loop bandwidth reduces as the charge pump current is reduced and vice versa.

Selecting Loop Filter Bandwidth

Data Rate

The loop filter bandwidth should usually be at two to three times the data rate. This ensures that the PLL has ample time to jump between the mark and space frequencies.

ACP

In the case where the ACP specifications are difficult to meet, the loop filter bandwidth can be reduced further to reduce the phase noise at the adjacent channel. The filter rolls off at 20 dB per decade.

Spurious Levels

In the case where the output power is quite high, a reduced loop filter bandwidth reduces the spurious levels even further, and provides additional margin on the specification.

The following sections provide examples of loop filter designs for typical applications in specific frequencies.

PA MATCHING

The ADF7012 exhibits optimum performance in terms of transmit power and current consumption only if the RF output port is properly matched to the antenna impedance.

$ZOPT_PA$ depends primarily on the required output power, and the frequency range. Selecting the optimum $ZOPT_PA$ helps to minimize the current consumption. This data sheet contains a number of matching networks for common frequency bands. Under certain conditions it is recommended to obtain a suitable $ZOPT_PA$ value by means of a load-pull measurement.

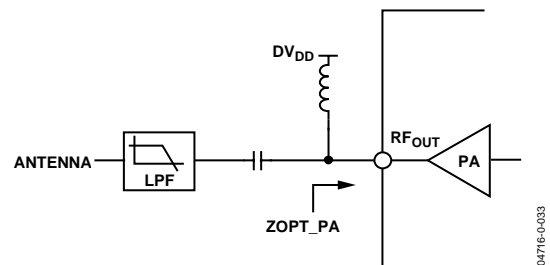

Figure 38. ADF7012 with Harmonic Filter

The impedance matching values provided in the next section are for 50 Ω environments. An additional matching network may be required after the harmonic filter to match to the antenna impedance. This can be incorporated into the filter design itself in order to reduce external components.

TRANSMIT PROTOCOL AND CODING CONSIDERATIONS

| PREAMBLE | SYNC WORD | ID FIELD | DATA FIELD | CRC |
|----------|-----------|----------|------------|-----|
| | | | | |

Figure 39. Typical Format of a Transmit Protocol

A dc-free preamble pattern such as 10101010... is recommended for FSK/ASK/OOK demodulation. Preamble patterns with longer run-length constraints such as 11001100.... can also be used. However, this can result in a longer synchronization time of the received bit stream in the chosen receiver.

APPLICATION EXAMPLES

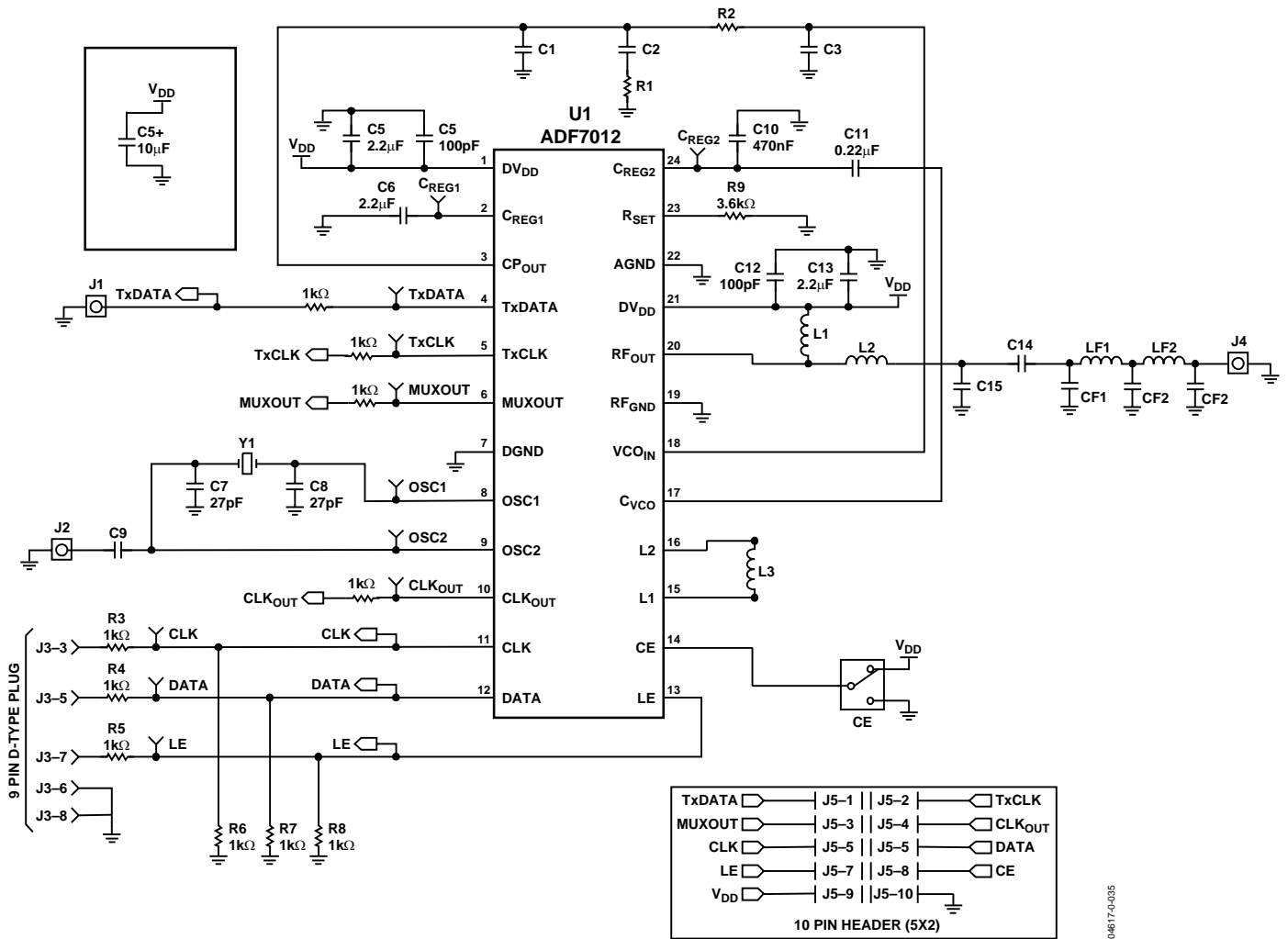

Figure 40. Applications Diagrams with Harmonic Filter

04617-9-035

315 MHz OPERATION

The recommendations here are guidelines only. The design should be subject to internal testing prior to FCC site testing. Matching components need to be adjusted for board layout.

The FCC standard 15.231 regulates operation in the band from 260MHz to 470MHz in the US. This is used generally in the transmission of RF control signals, such as in a satellite-decoder remote control, or remote keyless entry system. The band cannot be used to send any continuous signal. The maximum output power allowed is governed by the duty cycle of the system. A typical design example for a remote control is shown next.

Design Criteria

315 MHz center frequency
FSK/OOK modulation
1 mW output power
House range
Meets FCC 15.231

The main requirements in the design of this remote are a long battery life and sufficient range. It is possible to adjust the output power of the ADF7012 to increase the range depending on the antenna performance.

The center frequency is 315 MHz. Because the ADF7012 VCO is not recommended for operation in fundamental mode for frequencies below 400 MHz, the VCO needs to operate at 630 MHz. Figure 36 (Output Frequency vs. External Inductor Value) implies an inductor value of 7.6 nH or close to this. The chip inductor chosen = 7.5 nH (0402CS-7N5 from Coilcraft). Coil inductors are recommended to provide sufficient Q for oscillation.

Crystal and PFD

Phase noise requirements are not excessive as the adjacent channel power requirement is -20 dB. The PFD is chosen so as to minimize spurious levels (beat note and reference), and to ensure a quick crystal power-up time.

PFD = 3.6864 MHz – Power-Up Time 1.6ms. Figure 10 shows a typical power-on time for a 4 MHz crystal.

N-Divider

The N Divider is determined as being:

$N_{int} = 85$
 $N_{frac} = (1850)/4096$
VCO divide-by-2 is enabled

Deviation

The deviation is set to ± 50 kHz so as to accommodate a simple receiver architecture.

The modulation steps available are in $3.6864 \text{ MHz}/2^{14}$:

Modulation steps = 225 Hz
Modulation number = $50 \text{ kHz}/225 \text{ Hz} = 222$

Bias Current

Because low current is desired, a 2.0 mA VCO bias can be used. Additional bias current reduces any spur, but increases current consumption.

The PA bias can be set to 5.5 mA and achieve 0 dBm.

Loop Filter Bandwidth

The loop filter is designed with ADIsimPLL Version 2.5. The loop bandwidth design is straightforward because the 20 dB bandwidth is generally of the order of >400 kHz (0.25% of center frequency). A loop bandwidth of close to 100 kHz strikes a good balance between lock time and spurious suppression. If it is found that pulling of the VCO is more than desired in OOK mode, the bandwidth could be increased.

Design of Harmonic Filter

The main requirement of the harmonic filter should ensure that the third harmonic level is < -41.5 dBm. A fifth-order Chebyshev filter is recommended to achieve this, and a suggested starting point is given next. The Pi format is chosen to minimize the more expensive inductors.

Component Values—Crystal: 3.6864MHz

Loop Filter

| | |
|----------|----------|
| I_{CP} | 0.866 mA |
| LBW | 100 kHz |
| C1 | 680 pF |
| C2 | 12 nF |
| C3 | 220 pF |
| R1 | 1.1 kV |
| R2 | 3 kV |

Matching

| | |
|-----|-------|
| L1 | 56 nH |
| L2 | 1 nF |
| C14 | Short |
| C15 | Open |

Harmonic Filter

| | |
|-----|--------|
| L4 | 22 nH |
| L5 | 22 nH |
| CF1 | 3.3 pF |
| CF2 | 8.2 pF |
| CF3 | 3.3 pF |

433 MHZ OPERATION

The recommendations here are guidelines only. The design should be subject to internal testing prior to ETSI site testing. Matching components need to be adjusted for board layout.

The ETSI standard EN 300-220 governs operation in the 433.050 MHz to 434.790 MHz band. For many systems, 10% duty is sufficient for the transmitter to output 10 dBm.

Design Criteria

433.92 MHz center frequency
FSK modulation
10 mW output power
200 m range
Meets ETSI 300-220

The main requirement in the design of this remote is a long battery life and sufficient range. It is possible to adjust the output power of the ADF7012 to increase the range depending on the antenna performance.

The center frequency is 433.92 MHz. It is possible to operate the VCO at this frequency. Figure 36 shows the inductor value vs. center frequency. The inductor chosen is 22 nH. Coilcraft inductors such as 0603-CS-22NXJBU are recommended.

Crystal and PFD

The phase noise requirement is such to ensure the power at the edge of the band is < -36 dBm. The PFD is chosen so as to minimize spurious levels (beat note and reference), and to ensure a quick crystal power-up time.

PFD = 4.9152 MHz – Power-Up Time 1.6 ms. Figure 10 shows a typical power-up time for a 4 MHz crystal.

N-Divider

The N Divider is determined as being:

$N_{int} = 88$
 $N_{frac} = (1152)/4096$
VCO divide-by-2 is not enabled

Deviation

The deviation is set to ± 50 kHz so as to accommodate a simple receiver architecture.

The modulation steps available are in $4.9152 \text{ MHz}/2^{14}$:

Modulation steps = 300 Hz
Modulation number = $50 \text{ kHz}/300\text{Hz} = 167$

Bias Current

Because low current is desired, a 2.0 mA VCO bias can be used. Additional bias current reduces any spurious, but increases current consumption.

The PA bias can be set to 5.5 mA and achieve 10 dBm.

Loop Filter Bandwidth

The loop filter is designed with ADIsimPLL Version 2.5. The loop bandwidth design requires that the channel power be < -36 dBm at ± 870 kHz from the center. A loop bandwidth of close to 160 kHz strikes a good balance between lock time for data rates, including 32 kbps and spurious suppression. If it is found that pulling of the VCO is more than desired in OOK mode, the bandwidth could be increased.

Design of Harmonic Filter

The main requirement of the harmonic filter should ensure that the third harmonic level is < -30 dBm. A fifth-order Chebyshev filter is recommended to achieve this, and a suggested starting point is given next. The Pi format is chosen to minimize the more expensive inductors.

Component Values—Crystal: 4.9152 MHz

Loop Filter

| | |
|-----------------|----------------|
| I _{cp} | 2.0 mA |
| LBW | 100 kHz |
| C1 | 680 pF |
| C2 | 12 nF |
| C3 | 270 pF |
| R1 | 910 Ω |
| R2 | 3.3 k Ω |

Matching

| | |
|-----|-------|
| L1 | 22 nH |
| L2 | 10 pF |
| C14 | Short |
| C15 | Open |

Harmonic Filter

| | |
|-----|--------|
| L4 | 22 nH |
| L5 | 22 nH |
| CF1 | 3.3 pF |
| CF2 | 8.2 pF |
| CF3 | 3.3 pF |

868 MHz OPERATION

The recommendations here are guidelines only. The design should be subject to internal testing prior to ETSI site testing. Matching components need to be adjusted for board layout.

The ETSI standard EN 300-220 governs operation in the 868 MHz to 870MHz band. The band is broken down into several subbands each having a different duty cycle and output power requirement. Narrowband operation is possible in the 50kHz channels, but both the output power and data rate are limited by the -36 dBm adjacent channel power specification. There are many different applications in this band, including remote controls for security, sensor interrogation, metering and home control.

Design Criteria

868.95 MHz center frequency (band 868.7MHz – 869.2 MHz)
 FSK modulation
 12 dBm output power
 300 m range
 Meets ETSI 300-220
 38.4 kbps data rate

The design challenge is to enable the part to operate in this particular subband and meet the ACP requirement 250 kHz away from the center.

The center frequency is 868.95 MHz. It is possible to operate the VCO at this frequency. Figure 31 shows the inductor value vs. center frequency. The inductor chosen is 1.9 nH. Coilcraft inductors such as 0402-CS-1N9XJBU are recommended.

Crystal and PFD

The phase noise requirement is such to ensure the power at the edge of the band is < -36 dBm. This requires close to -100 dBc/Hz phase noise at the edge of the band.

The PFD is chosen so as to minimize spurious levels (beat note and reference), and to ensure a quick crystal power-up time. A PFD of < 6 MHz places the largest PFD spur at a frequency of greater than 862 MHz, and so reduces the requirement on the spur level to -36 dBm instead of -54 dBm.

PFD = 4.9152 MHz – Power Up-Time 1.6 ms. Figure 10 shows a typical power-on time for a 4MHz crystal.

N-Divider

The N divider is determined as being:

$$N_{int} = 176$$

$$N_{frac} = (3229)/4096$$

VCO divide-by-2 is not enabled.

Deviation

The deviation is set to ±19.2 kHz so as to accommodate a simple receiver architecture and also ensure that the modulation spectrum is narrow enough to meet the adjacent channel power (ACP) requirements.

The modulation steps available are in 4.9152 MHz/2¹⁴:

$$\text{Modulation steps} = 300 \text{ Hz}$$

$$\text{Modulation number} = 19.2 \text{ kHz}/300 \text{ Hz} = 64.$$

Bias Current

Because low current is desired, a 2.5 mA VCO bias can be used. Additional bias current reduces any spurious, but increases current consumption. A 2.5 mA bias current gives the best spurious vs. phase noise trade-off.

The PA bias should be set to 7.5 mA to achieve 12 dBm.

Loop Filter Bandwidth

The loop filter is designed with ADIsimPLL Version 2.5. The loop bandwidth design requires that the channel power be < -36 dBm at ±250 kHz from the center. A loop bandwidth of close to <60 kHz is required to bring the phase noise at the edge of the band sufficiently low to meet the ACP specification. This represents a compromise between the data rate requirement and the phase noise requirement.

Design of Harmonic Filter

The main requirement of the harmonic filter should ensure that the second and third harmonic levels are < -30 dBm. A fifth-order Chebyshev filter is recommended to achieve this, and a suggested starting point is given next. The Pi format is chosen to minimize the more expensive inductors.

Component Values—Crystal: 4.9152 MHz

Loop Filter

| | |
|-----|---------|
| Icp | 1.44 mA |
| LBW | 60 kHz |
| C1 | 1.5 nF |
| C2 | 22 nF |
| C3 | 560 pF |
| R1 | 390 Ω |
| R2 | 910 Ω |

Matching

| | |
|-----|--------|
| L1 | 27 nH |
| L2 | 6.2 nH |
| C14 | 470 pF |
| C15 | Open |

Harmonic Filter

| | |
|-----|--------|
| L4 | 8.2 nH |
| L5 | 8.2 nH |
| CF1 | 4.7 pF |
| CF2 | 6.8 pF |
| CF3 | 4.7 pF |

915 MHZ OPERATION

The recommendations here are guidelines only. The design should be subject to internal testing prior to FCC site testing. Matching components need to be adjusted for board layout.

FCC 15.247 and FCC 15.249 are the main regulations governing operation in the 902 MHz to 928 MHz Band. FCC 15.247 requires some form of spectral spreading. Typically, the ADF7012 would be used in conjunction with the frequency hopping spread spectrum (FHSS) or it may be used in conjunction with the digital modulation standard which requires large deviation frequencies. Output power of < 1 W is tolerated on certain spreading conditions.

Compliance with FCC 15.249 limits the output power to -1.5 dBm, but does not require spreading. There are many different applications in this band, including remote controls for security, sensor interrogation, metering, and home control.

Design Criteria

915.2MHz center frequency
FSK modulation
10 dBm output power
200 m range
Meets FCC 15.247
38.4 kbps data rate

The center frequency is 915.2 MHz. It is possible to operate the VCO at this frequency. Figure 36 shows the inductor value vs. center frequency. The inductor chosen is 1.6 nH. Coilcraft inductors such as 0603-CS-1N6XJBU are recommended. Additional hopping frequencies can easily be generated by changing the N value.

Crystal and PFD

The phase noise requirement is such to ensure that the 20 dB bandwidth requirements are met. These are dependant on the channel spacing chosen. A typical channel spacing would be 400 kHz, which would allow 50 channels in 20 MHz and enable the design to avoid the edges of the band.

The PFD is chosen so as to minimize spurious levels. There are beat note spurious levels at 910 MHz and 920 MHz, but the level is usually significantly less than the modulation power. They are also attenuated quickly by the loop filter to ensure a quick crystal power-up time.

PFD = 10 MHz – Power-Up Time 1.8 ms (approximately).
Figure 10 shows a typical power-on time for a 4 MHz crystal.

N-Divider

The N divider is determined as being:

$$N_{int} = 91$$

$$N_{frac} = (2130)/4096$$

VCO divide-by-2 is not enabled

Deviation

The deviation is set to ± 19.2 kHz so as to accommodate a simple receiver architecture, and also to ensure the available spectrum is used efficiently.

The modulation steps available are in $10 \text{ MHz}/2^{14}$:

$$\text{Modulation steps} = 610 \text{ Hz}$$

$$\text{Modulation number} = 19.2 \text{ kHz}/610 \text{ Hz} = 31.$$

Bias Current

Because low current is desired, a 3 mA VCO bias can be used and still ensure oscillation at 928 MHz. Additional bias current reduces any spurious noise, but increases current consumption. A 3 mA bias current gives the best spurious vs. phase noise trade-off.

The PA bias should be set to 5.5 mA to achieve 10 dBm power.

Loop Filter Bandwidth

The loop filter is designed with ADIsimPLL Version 2.5. A data rate of 170 kHz is chosen, which allows for data rates of > 38.4 kbps. It also attenuates the beat note spurs quickly to ensure they have no effect on system performance.

Design of Harmonic Filter

The main requirement of the harmonic filter should ensure that the third harmonic level is < -41.5 dBm. A fifth-order Chebyshev filter is recommended to achieve this, and a suggested starting point is given next. The Pi format is chosen to minimize the number of inductors in the system.

Component Values—Crystal: 10 MHz

Loop Filter

| | |
|-----|----------------|
| Icp | 1.44 mA |
| LBW | 170 kHz |
| C1 | 470 pF |
| C2 | 12 nF |
| C3 | 120 pF |
| R1 | 470 Ω |
| R2 | 1.8 k Ω |

Matching

| | |
|-----|--------|
| L1 | 27 nH |
| L2 | 6.2 nH |
| C14 | 470 pF |
| C15 | Open |

Harmonic Filter

| | |
|-----|--------|
| L4 | 8.2 nH |
| L5 | 8.2 nH |
| CF1 | 4.7 pF |
| CF2 | 6.8 pF |
| CF3 | 4.7 pF |

REGISTER DESCRIPTIONS

R REGISTER

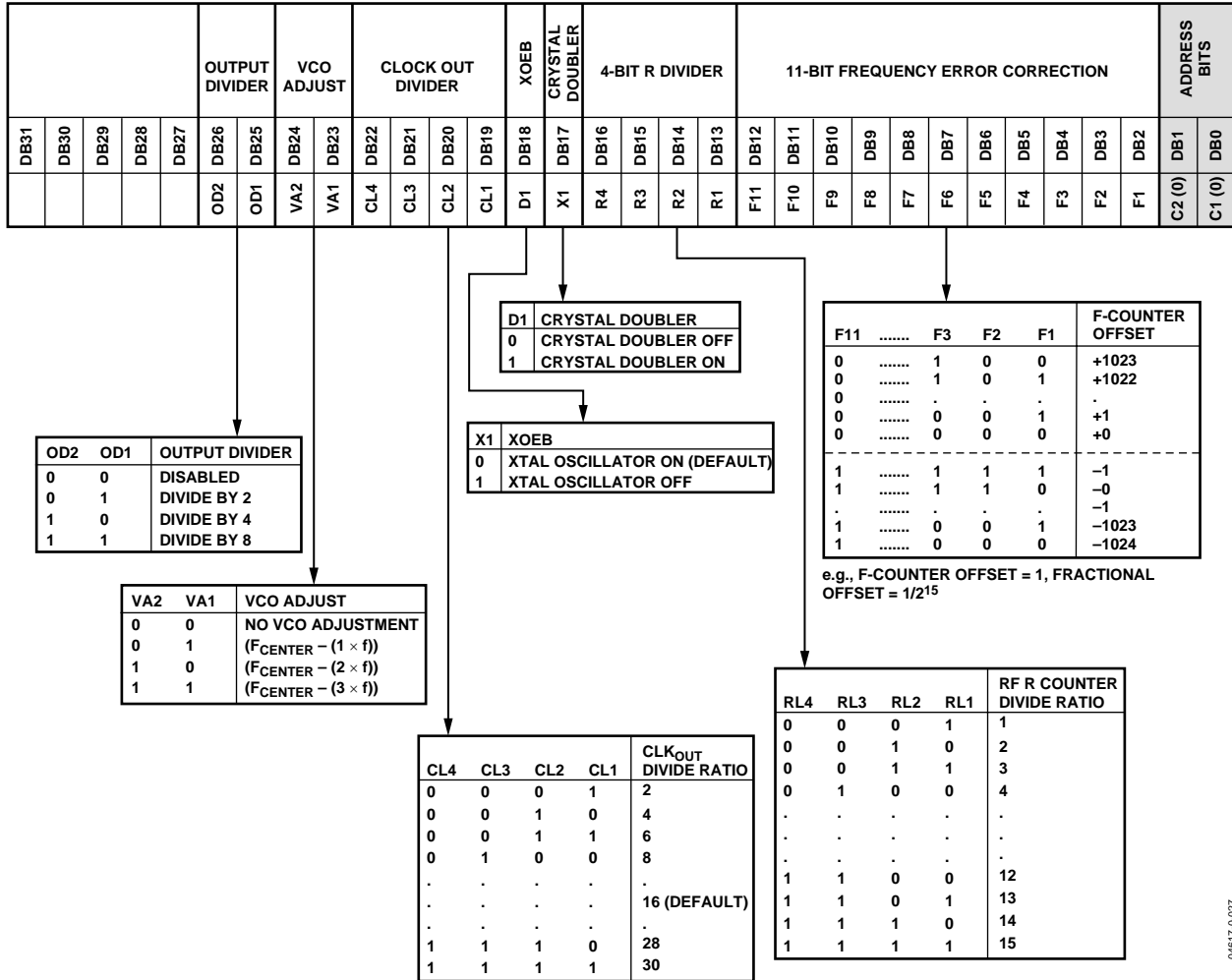
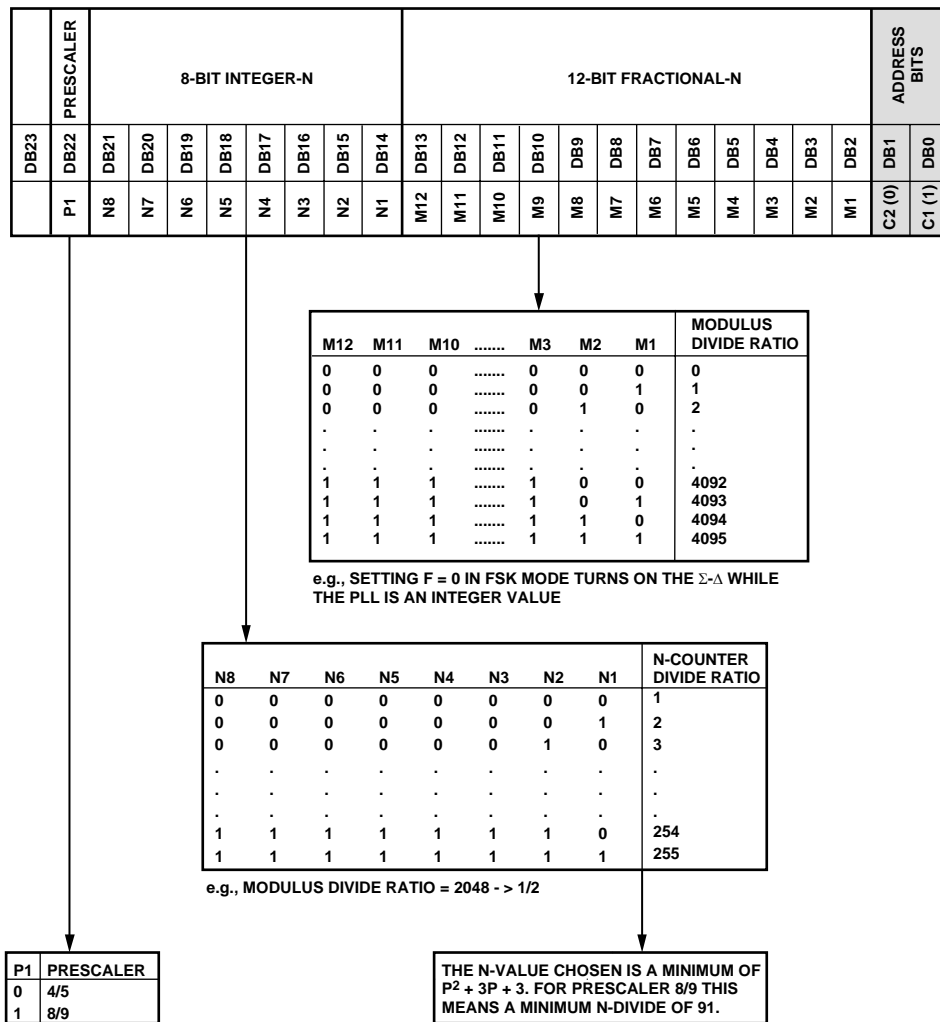

Figure 41.

04617-0-027

N-COUNTER LATCH



04817-0-028

Figure 42.

MODULATION REGISTER

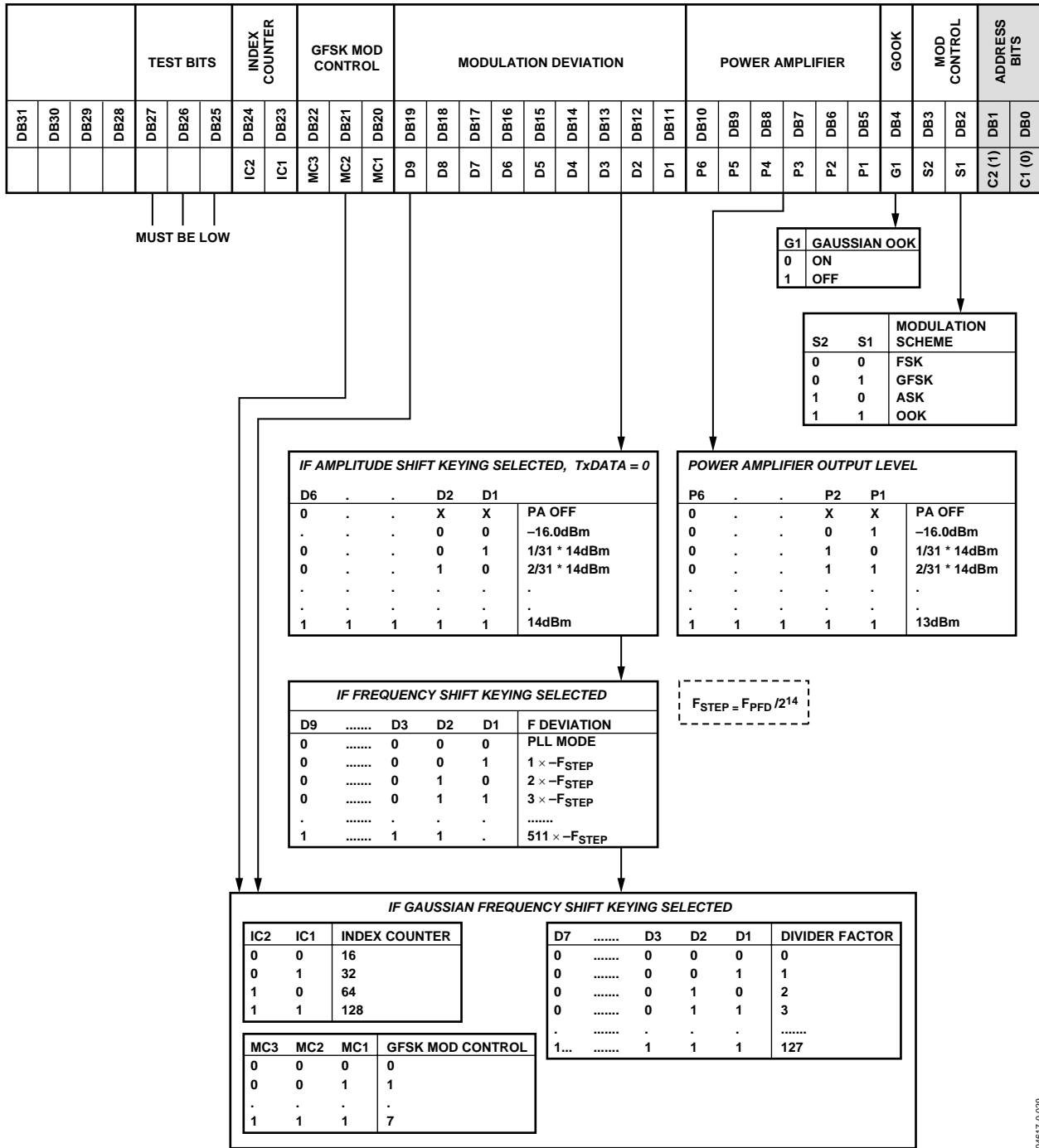

04617-0-029

Figure 43.

FUNCTION REGISTER

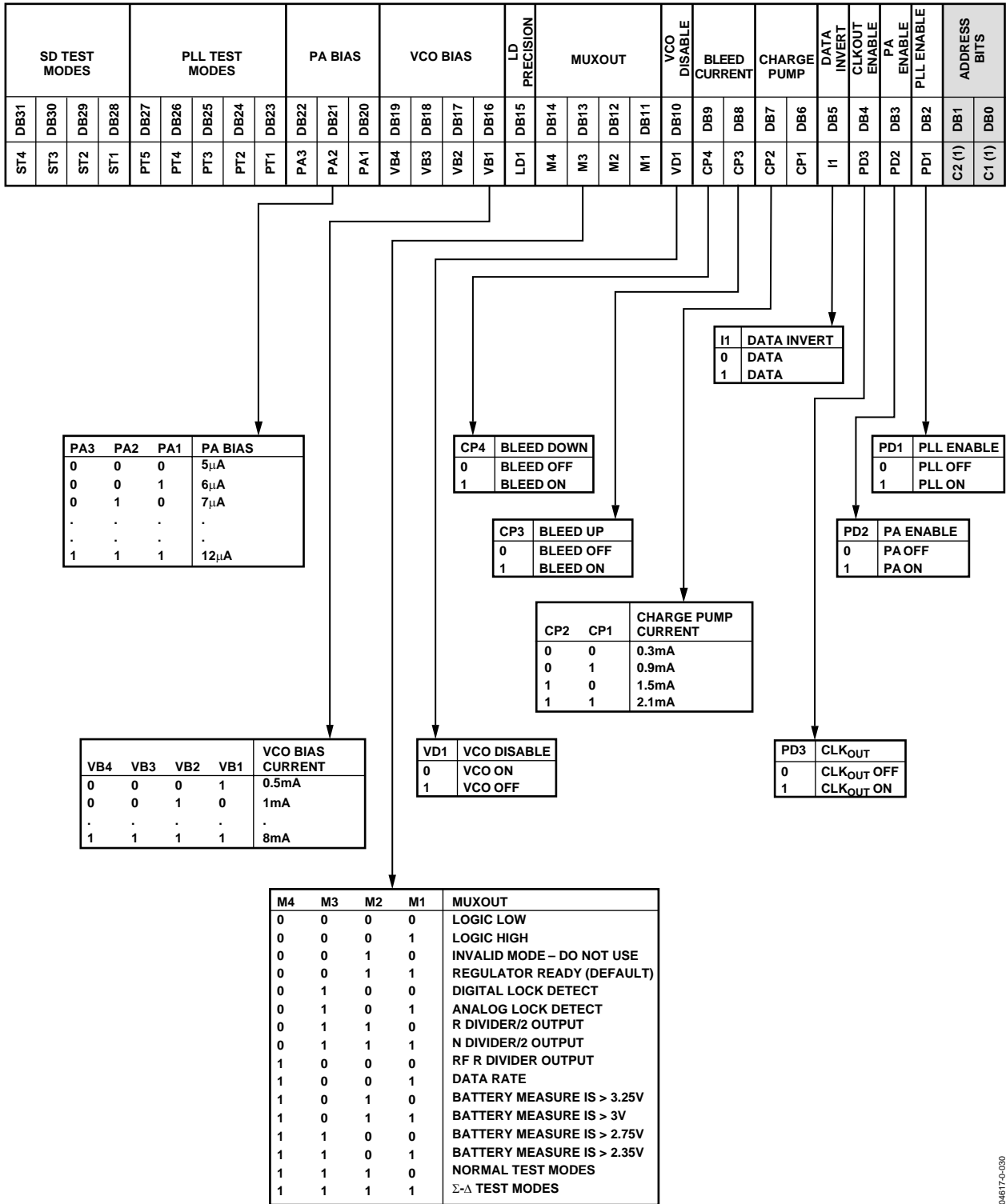

Figure 44.

OUTLINE DIMENSIONS

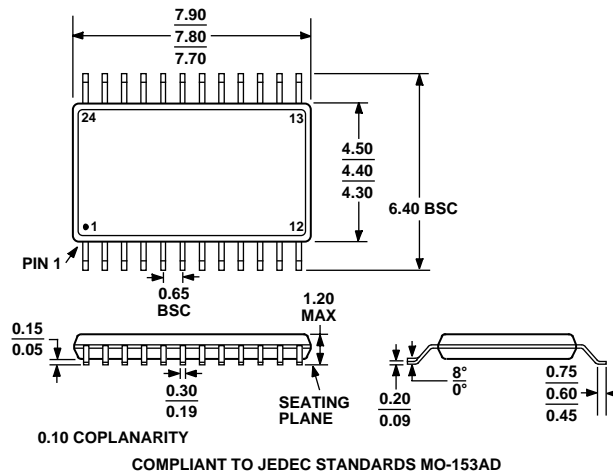

Figure 45. 24-Lead Thin Shrink Small Outline Package [TSSOP] (RU-24)

ORDERING GUIDE

| Model | Temperature Range | Package Description | Package Option | Frequency Range |
|------------------|-------------------|---------------------|----------------|--------------------|
| ADF7012BRU | -40°C to +85°C | TSSOP | RU-24 | 50 MHz to 1 GHz |
| ADF7012BRU-REEL | -40°C to +85°C | TSSOP, 13" REEL | RU-24 | 50 MHz to 1 GHz |
| ADF7012BRU-REEL7 | -40°C to +85°C | TSSOP, 7" REEL | RU-24 | 50 MHz to 1 GHz |
| EVAL-ADF7012EB1 | | Evaluation Board | | 902 MHz to 928 MHz |
| EVAL-ADF7012EB2 | | Evaluation Board | | 860 MHz to 880 MHz |
| EVAL-ADF7012EB3 | | Evaluation Board | | 418 MHz to 435 MHz |
| EVAL-ADF7012EB4 | | Evaluation Board | | 310 MHz to 330 MHz |
| EVAL-ADF7012EB5 | | Evaluation Board | | 50 MHz to 1 GHz |