

# LM4991 Boomer® Audio Power Amplifier Series

## 3W Audio Power Amplifier with Shutdown Mode

### General Description

The LM4991 is a mono bridged audio power amplifier capable of delivering 3W of continuous average power into a 3Ω load with less than 10% THD when powered by a 5V power supply (Note 1). To conserve power in portable applications, the LM4991's micropower shutdown mode ( $I_{SD} = 0.1\mu A$ , typ) is activated when  $V_{DD}$  is applied to the SHUTDOWN pin.

Boomer audio power amplifiers are designed specifically to provide high power, high fidelity audio output. They require few external components and operate on low supply voltages from 2.2V to 5.5V. Since the LM4991 does not require output coupling capacitors, bootstrap capacitors, or snubber networks, it is ideally suited for low-power portable systems that require minimum volume and weight.

Additional LM4991 features include thermal shutdown protection, unity-gain stability, and external gain set.

**Note 1:** An LM4991LD that has been properly mounted to a circuit board will deliver 3W into 3Ω (at 10% THD). The other package options for the LM4991 will deliver 1.5W into 8Ω (at 10% THD). See the **Application Information** sections for further information concerning the LM4991LD and LM4991M.

### Key Specifications

- Improved PSRR at 217kHz and 1kHz 64dB (typ)
- $P_O$  at  $V_{DD} = 5.0V$ , 10% THD, 1kHz
- LM4991LD (only), 3Ω, 4Ω 3W (typ), 2.5W (typ)
- All packages, 8Ω load 1.5W (typ)
- Shutdown current 0.1μA (typ)

### Features

- Available in space-saving LLP and MA packages
- Ultra low current shutdown mode
- Can drive capacitive loads up to 500pF
- Improved pop & click circuitry reduces noises during turn-on and turn-off transitions
- 2.2 - 5.5V operation
- No output coupling capacitors, snubber networks, bootstrap capacitors or gain-setting resistors required
- Unity-gain stable

### Applications

- Wireless and cellular handsets
- PDA's
- Portable computers
- Desktop computers

### Connection Diagrams

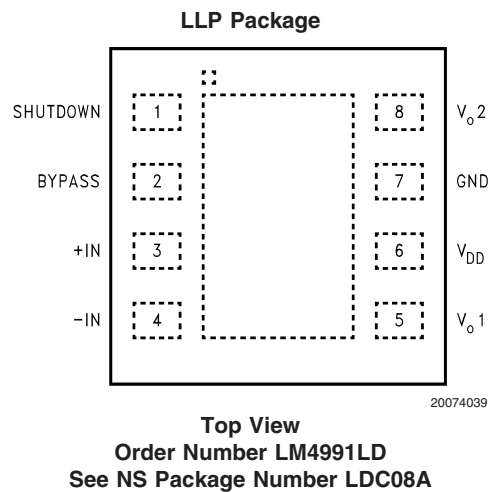
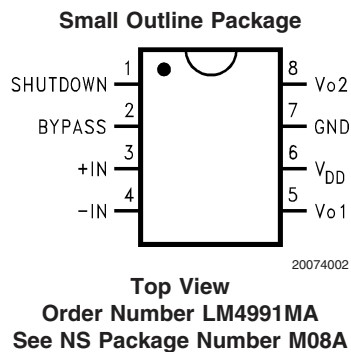

Boomer® is a registered trademark of National Semiconductor Corporation.

## Typical Application

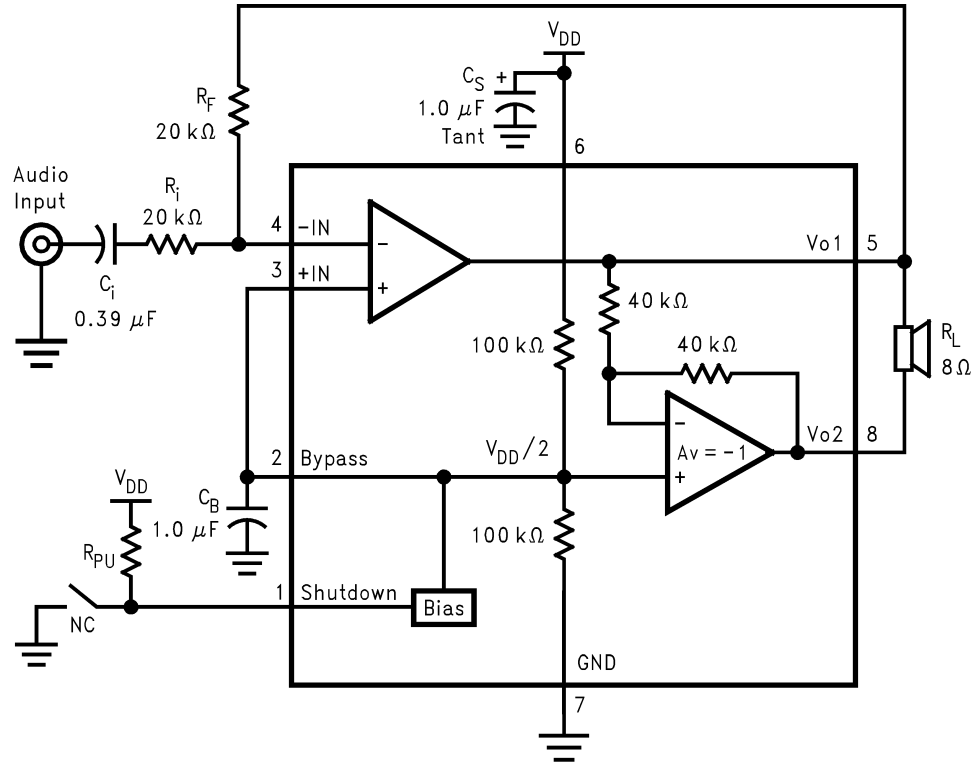

20074001

FIGURE 1. Typical Audio Amplifier Application Circuit

**Absolute Maximum Ratings** (Note 2)

If Military/Aerospace specified devices are required, please contact the National Semiconductor Sales Office/Distributors for availability and specifications.

Supply Voltage	6.0V
Supply Temperature	-65°C to +150°C
Input Voltage	-0.3V to $V_{DD}$ to +0.3V
Power Dissipation (Note 4)	Internally Limited
ESD Susceptibility (Note 5)	2000V
ESD Susceptibility (Note 6)	200V
Junction Temperature	150°C

Thermal Resistance

$\theta_{JC}$ (LD) (Note 9)	4.3°C/W
$\theta_{JA}$ (LD)	56°C/W
$\theta_{JC}$ (MA)	35°C/W
$\theta_{JA}$ (MA)	140°C/W

**Operating Ratings**

Temperature Range

$T_{MIN} \leq T_A \leq T_{MAX}$	-40°C $\leq T_A \leq$ +85°C
Supply Voltage	2.2V $\leq V_{DD} \leq$ 5.5V

**Electrical Characteristics  $V_{DD} = 5V$**  (Notes 2, 3)

The following specifications apply for  $V_{DD} = 5V$  and  $R_L = 8\Omega$  unless otherwise specified. Limits apply for  $T_A = 25^\circ\text{C}$ .

Symbol	Parameter	Conditions	LM4991		Units (Limits)
			Typical (Note 7)	Limit (Note 8)	
$I_{DD}$	Quiescent Power Supply Current	$V_{IN} = 0V$ , no Load	3	7	mA (max)
		$V_{IN} = 0V$ , $R_L = 8\Omega$	4	10	
$I_{SD}$	Shutdown Current	$V_{SHUTDOWN} = V_{DD}$	0.1	2.0	$\mu\text{A}$ (max)
$V_{SDIH}$	Shutdown Voltage		1.5		V
$V_{SDIL}$			1.3		V
$V_{OS}$	Output Offset Voltage		5	35	mV (max)
$P_O$	Output Power	THD = 1% (max), $f = 1\text{kHz}$			W (min)
		LM4991LD, $R_L = 3\Omega$ (Note 10)	2.38		
		LM4991LD, $R_L = 4\Omega$ (Note 10)	2.1		
		LM4991, $R_L = 8\Omega$	1.3	0.9	
		THD+N = 10%, $f = 1\text{kHz}$			W
		LM4991LD, $R_L = 3\Omega$ (Note 10)	3		
		LM4991LD, $R_L = 4\Omega$ (Note 10)	2.5		
		LM4991, $R_L = 8\Omega$	1.5		
THD+N	Total Harmonic Distortion+Noise	$P_O = 0.5W$ , $f = 1\text{kHz}$	0.2		%
PSRR	Power Supply Rejection Ratio	$V_{RIPPLE} = 200\text{mV}$ sine p-p, Input terminated with $10\Omega$ , $f = 1\text{kHz}$	64	55	dB (min)

**Electrical Characteristics  $V_{DD} = 3V$**  (Notes 2, 3)

The following specifications apply for  $V_{DD} = 3V$  and  $R_L = 8\Omega$  unless otherwise specified. Limits apply for  $T_A = 25^\circ\text{C}$ .

Symbol	Parameter	Conditions	LM4991		Units (Limits)
			Typical (Note 7)	Limit (Note 8)	
$I_{DD}$	Quiescent Power Supply Current	$V_{IN} = 0V$ , no Load	3	7	mA (max)
		$V_{IN} = 0V$ , $R_L = 8\Omega$	4	7	
$I_{SD}$	Shutdown Current	$V_{SHUTDOWN} = V_{DD}$	0.1	2.0	$\mu\text{A}$ (max)
$V_{SDIH}$	Shutdown Voltage Input High		1.1		V
$V_{SDIL}$	Shutdown Voltage Input Low		0.9		V
$V_{OS}$	Output Offset Voltage		5	35	mV (max)
$P_O$	Output Power	THD = 1% (max), $f = 1\text{kHz}$			mW
		$R_L = 4\Omega$	600		
		$R_L = 8\Omega$	425		
THD+N	Total Harmonic Distortion+Noise	$P_O = 0.25W$ , $f = 1\text{kHz}$	0.1		%

### Electrical Characteristics $V_{DD} = 3V$ (Notes 2, 3)

The following specifications apply for  $V_{DD} = 3V$  and  $R_L = 8\Omega$  unless otherwise specified. Limits apply for  $T_A = 25^\circ C$ . (Continued)

Symbol	Parameter	Conditions	LM4991		Units (Limits)
			Typical (Note 7)	Limit (Note 8)	
PSRR	Power Supply Rejection Ratio	$V_{RIPPLE} = 200mV$ sine p-p, Input terminated with $10\Omega$ , $f = 1kHz$	68		dB

### Electrical Characteristics $V_{DD} = 2.6V$ (Notes 2, 3)

The following specifications apply for  $V_{DD} = 2.6V$  and  $R_L = 8\Omega$  unless otherwise specified. Limits apply for  $T_A = 25^\circ C$ .

Symbol	Parameter	Conditions	LM4991		Units (Limits)
			Typical (Note 7)	Limit (Note 8)	
$I_{DD}$	Quiescent Power Supply Current	$V_{IN} = 0V$ , no Load	2		mA (max)
		$V_{IN} = 0V$ , $R_L = 8\Omega$	3		
$I_{SD}$	Shutdown Current	$V_{SHUTDOWN} = V_{DD}$	0.1		$\mu A$ (max)
$V_{SDIH}$	Shutdown Voltage Input High		1		V
$V_{SDIL}$	Shutdown Voltage Input Low		0.9		V
$V_{OS}$	Output Offset Voltage		5	35	mV (max)
$P_o$	Output Power	THD = 1% (max), $f = 1kHz$			mW
		$R_L = 4\Omega$ $R_L = 8\Omega$	400 300		
THD+N	Total Harmonic Distortion+Noise	$P_O = 0.15W$ , $f = 1kHz$	0.1		%
PSRR	Power Supply Rejection Ratio	$V_{RIPPLE} = 200mV$ sine p-p, Input terminated with $10\Omega$ , $f = 1kHz$	51		dB

**Note 2:** *Absolute Maximum Ratings* indicate limits beyond which damage to the device may occur. *Operating Ratings* indicate conditions for which the device is functional, but do not guarantee specific performance limits. *Electrical Characteristics* state DC and AC electrical specifications under particular test conditions which guarantee specific performance limits. This assumes that the device is within the Operating Ratings. Specifications are not guaranteed for parameters where no limit is given, however, the typical value is a good indication of device performance.

**Note 3:** All voltages are measured with respect to the ground pin, unless otherwise specified.

**Note 4:** The maximum power dissipation must be derated at elevated temperatures and is dictated by  $T_{JMAX}$ ,  $\theta_{JA}$ , and the ambient temperature  $T_A$ . The maximum allowable power dissipation is  $P_{DMAX} = (T_{JMAX} - T_A) / \theta_{JA}$  or the number given in Absolute Maximum Ratings, whichever is lower. For the LM4991,  $T_{JMAX} = 150^\circ C$ . For the  $\theta_{JA}$ 's for different packages, please see the **Application Information** section or the **Absolute Maximum Ratings** section.

**Note 5:** Human body model, 100pF discharged through a 1.5k $\Omega$  resistor.

**Note 6:** Machine Model, 220pF–240pF discharged through all pins.

**Note 7:** Typical values are specified at  $25^\circ C$  and represent the parametric norm.

**Note 8:** Limits are guaranteed to National's AOQL (Average Outgoing Quality Level).

**Note 9:** The given  $\theta_{JA}$  is for an LM4991 packaged in an LDC08A with the Exposed-DAP soldered to an exposed 1in<sup>2</sup> area of 1oz printed circuit board copper.

**Note 10:** When driving 3 $\Omega$  or 4 $\Omega$  loads from a 5V supply, the LM4991LD must be mounted to a circuit board.

## External Components Description

(Figure 1)

Components		Functional Description
1.	$R_i$	Inverting input resistance that sets the closed-loop gain in conjunction with $R_f$ . This resistor also forms a high pass filter with $C_i$ at $f_c = 1/(2\pi R_i C_i)$ .
2.	$C_i$	Input coupling capacitor that blocks the DC voltage at the amplifiers input terminals. Also creates a highpass filter with $R_i$ at $f_c = 1/(2\pi R_i C_i)$ . Refer to the section, <b>Proper Selection of External Components</b> , for an explanation of how to determine the value of $C_i$ .
3.	$R_f$	Feedback resistance that sets the closed-loop gain in conjunction with $R_i$ .
4.	$C_S$	Supply bypass capacitor that provides power supply filtering. Refer to the <b>Power Supply Bypassing</b> section for information concerning proper placement and selection of the supply bypass capacitor.
5.	$C_B$	Bypass pin capacitor that provides half-supply filtering. Refer to the section, <b>Proper Selection of External Components</b> , for information concerning proper placement and selection of $C_B$ .

## Typical Performance Characteristics LD and MH Specific Characteristics

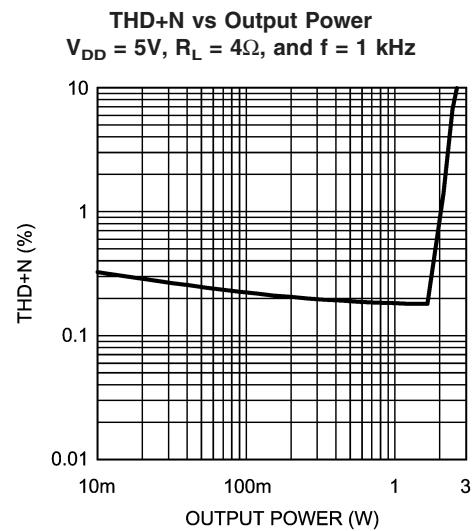
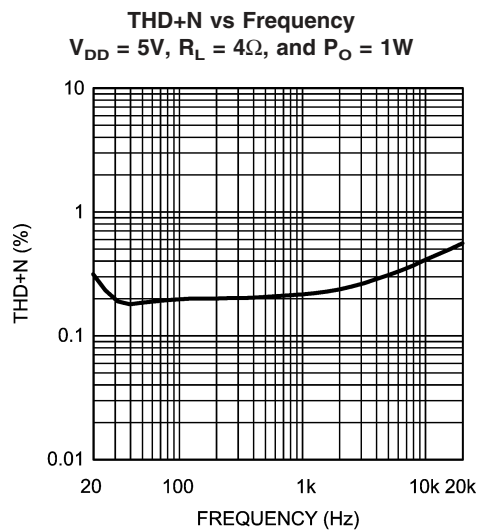

## Typical Performance Characteristics

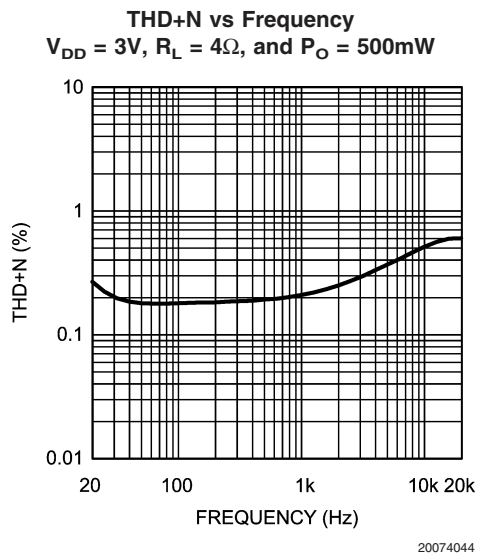
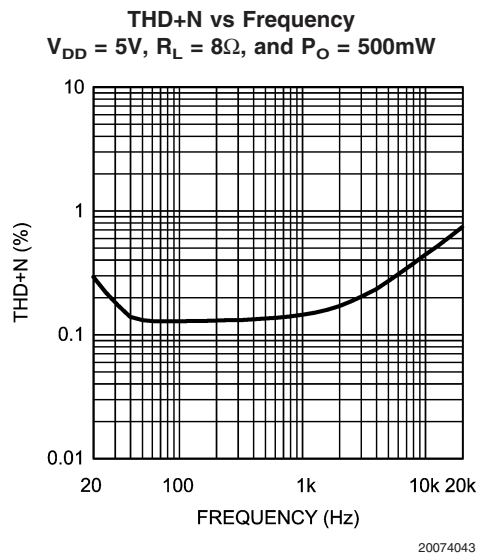

Typical Performance Characteristics (Continued)

**THD+N vs Frequency**  
 $V_{DD} = 3V$ ,  $R_L = 8\Omega$ , and  $P_O = 250mW$

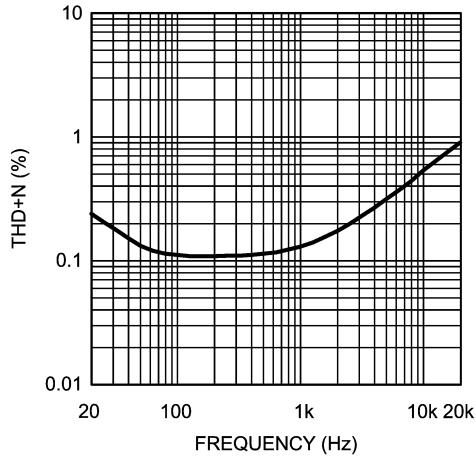

20074045

**THD+N vs Frequency**  
 $V_{DD} = 2.6V$ ,  $R_L = 4\Omega$ , and  $P_O = 150mW$

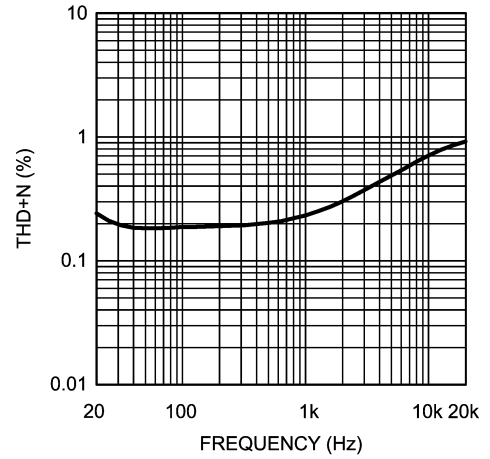

20074046

**THD+N vs Frequency**  
 $V_{DD} = 2.6V$ ,  $R_L = 8\Omega$ , and  $P_O = 150mW$

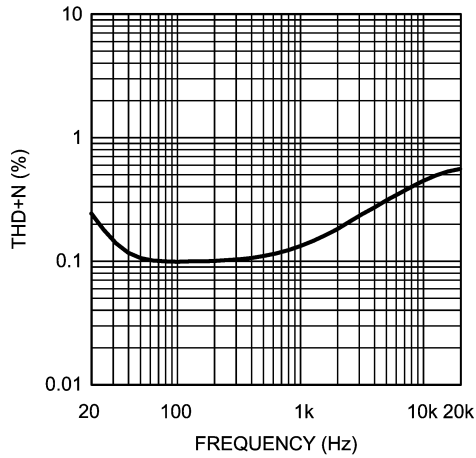

20074047

**THD+N vs Output Power**  
 $V_{DD} = 5V$ ,  $R_L = 8\Omega$ , and  $f = 1kHz$

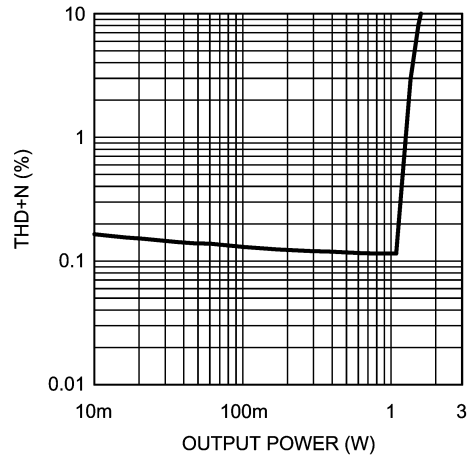

20074048

**THD+N vs Output Power**  
 $V_{DD} = 3V$ ,  $R_L = 4\Omega$ , and  $f = 1kHz$

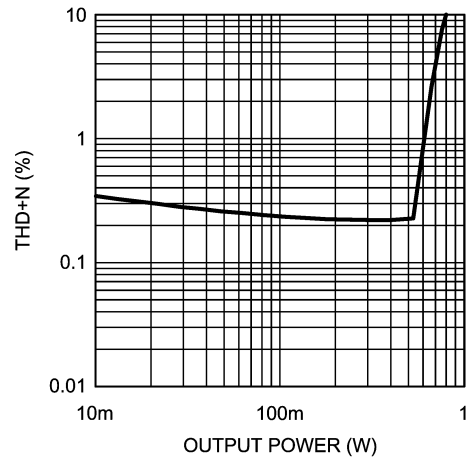

20074049

**THD+N vs Output Power**  
 $V_{DD} = 3V$ ,  $R_L = 8\Omega$ , and  $f = 1kHz$

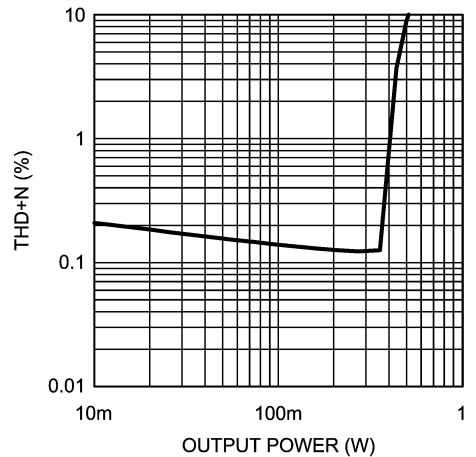

20074050

Typical Performance Characteristics (Continued)

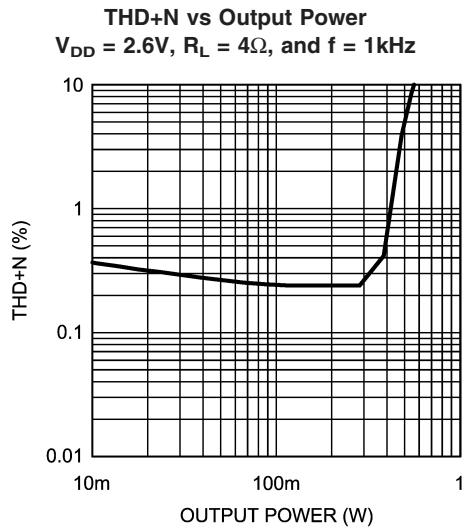

20074051

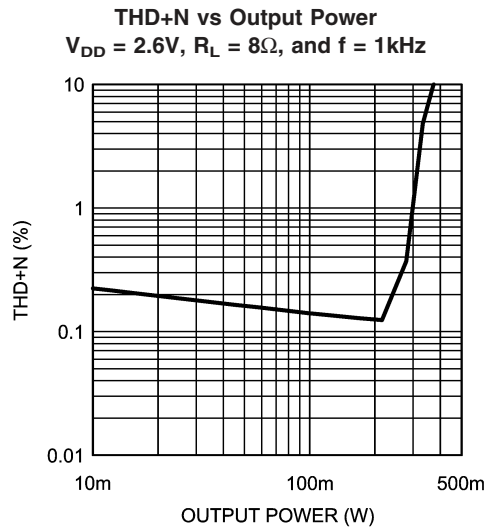

20074052

**Power Supply Rejection Ratio (PSRR) vs Frequency**  
 $V_{DD} = 5V, R_L = 8\Omega, \text{ input } 10\Omega \text{ terminated}$

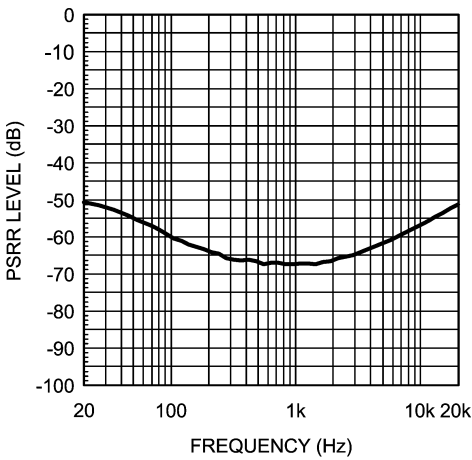

20074053

**Power Supply Rejection Ratio (PSRR) vs Frequency**  
 $V_{DD} = 5V, R_L = 8\Omega, \text{ input floating}$

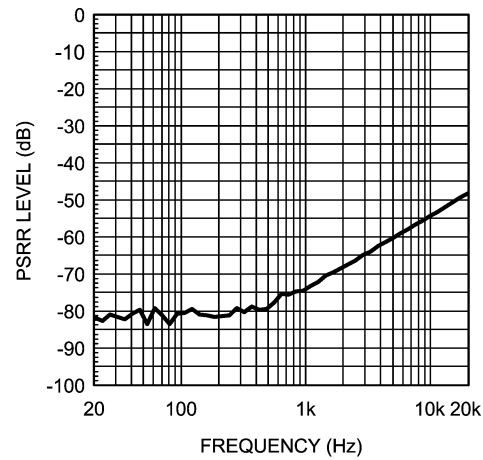

20074054

**Power Supply Rejection Ratio (PSRR) vs Frequency**  
 $V_{DD} = 3V, R_L = 8\Omega, \text{ input } 10\Omega \text{ terminated}$

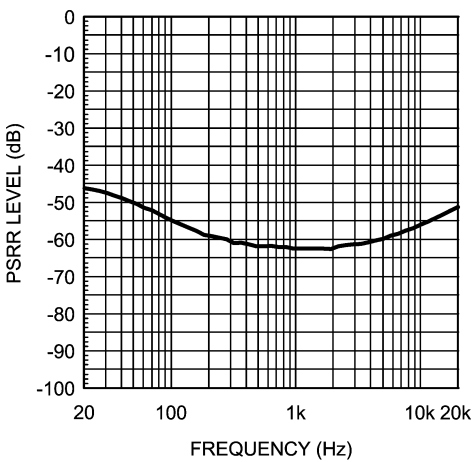

20074055

**Power Supply Rejection Ratio (PSRR) vs Frequency**  
 $V_{DD} = 3V, R_L = 8\Omega, \text{ input floating}$

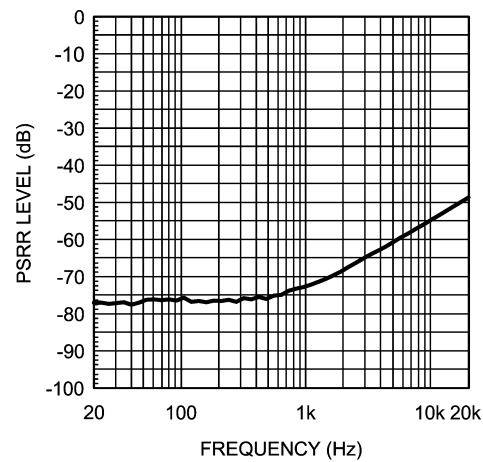

20074056

# Typical Performance Characteristics (Continued)

**Power Supply Rejection Ratio (PSRR) vs Frequency**  
 $V_{DD} = 2.6V$ ,  $R_L = 8\Omega$ , input  $10\Omega$  terminated

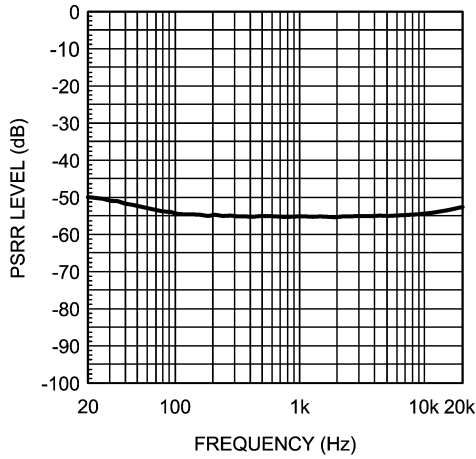

20074057

**Power Supply Rejection Ratio (PSRR) vs Frequency**  
 $V_{DD} = 2.6V$ ,  $R_L = 8\Omega$ , Input Floating

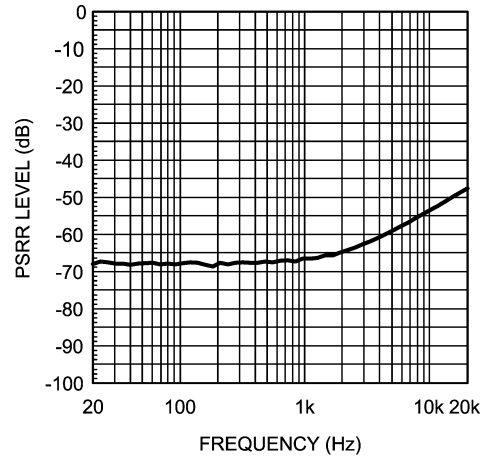

20074058

**Open Loop Frequency Response, 5V**

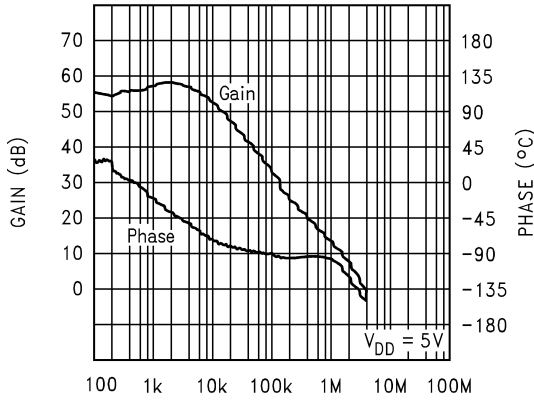

20074059

**Noise Floor, 5V, 8Ω**  
 80kHz Bandwidth, Input to GND

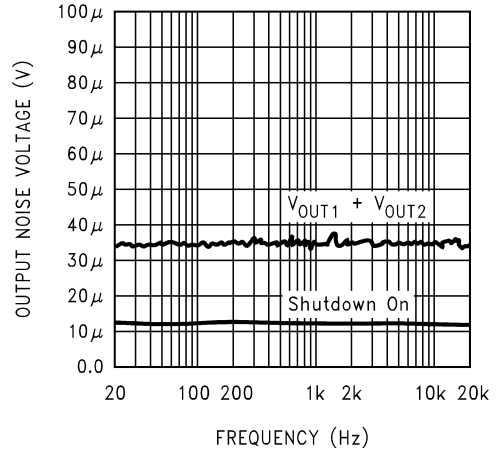

20074060

**Power Dissipation vs Output Power,  $V_{DD} = 5V$**

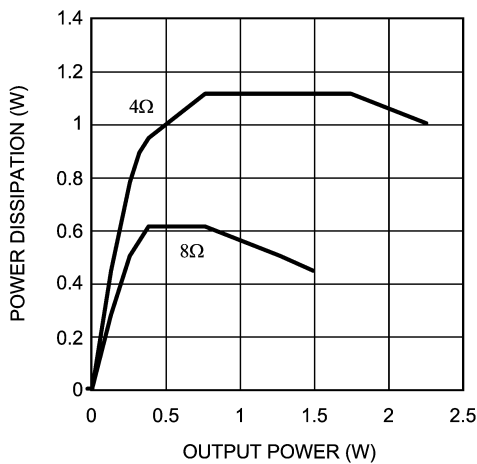

20074061

**Power Dissipation vs Output Power,  $V_{DD} = 3V$**

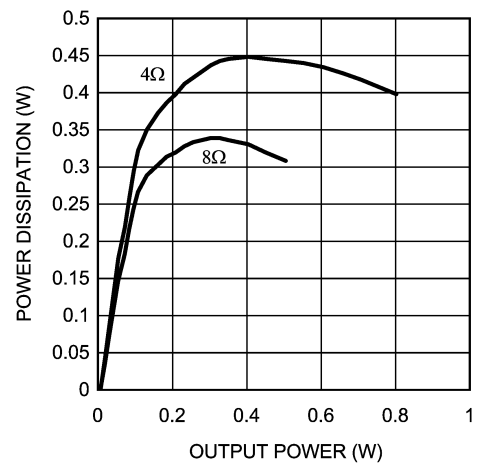

20074062



Typical Performance Characteristics (Continued)

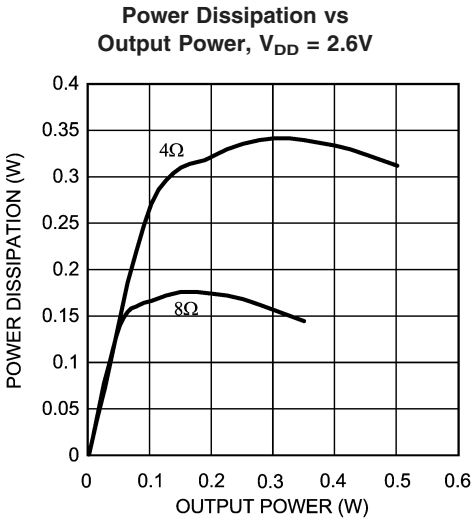

20074063

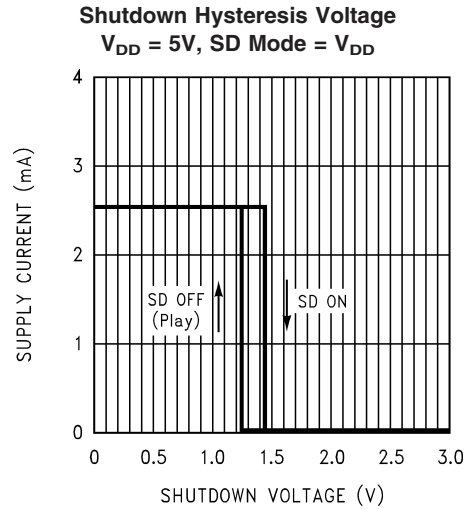

20074072

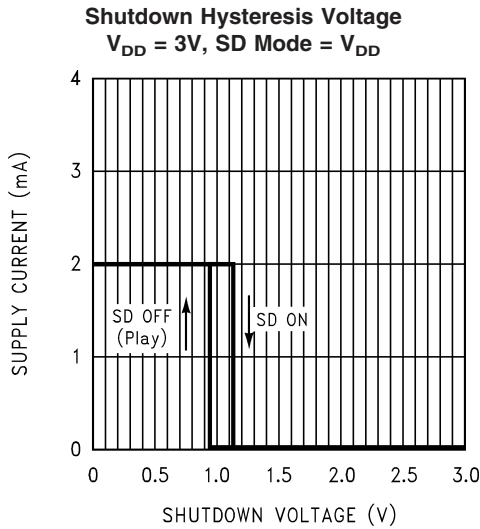

20074073

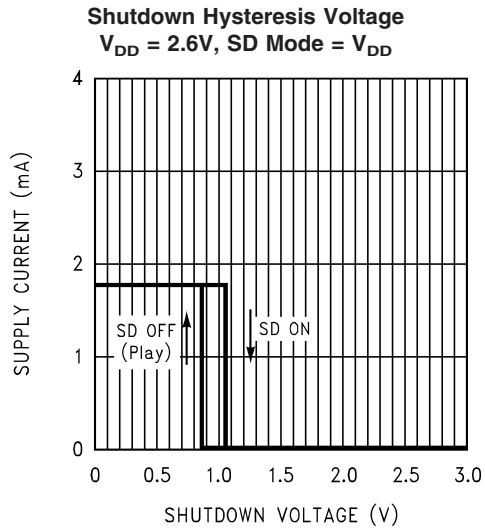

20074074

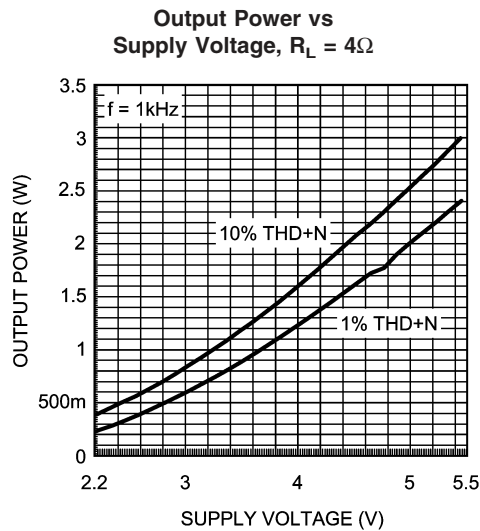

20074067

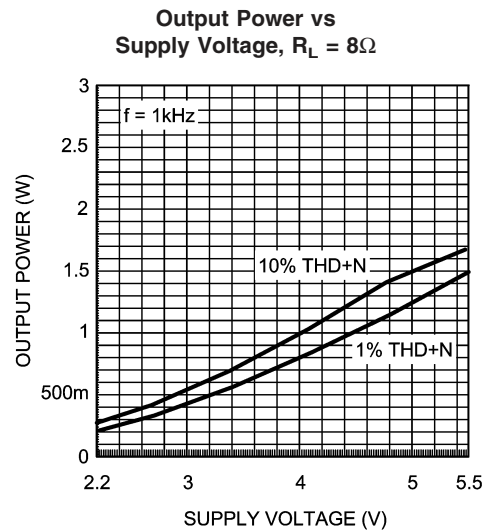

20074068

## Typical Performance Characteristics (Continued)

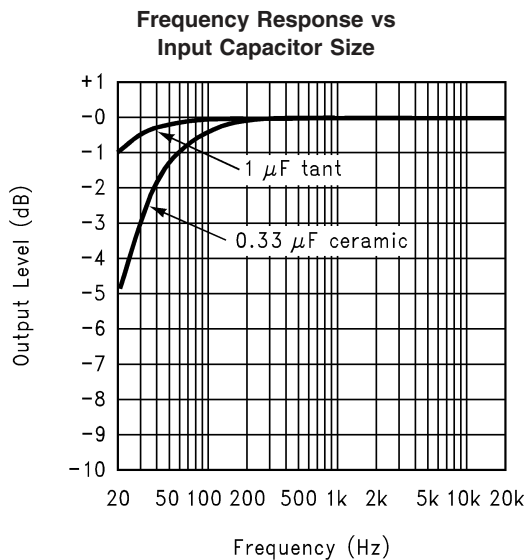
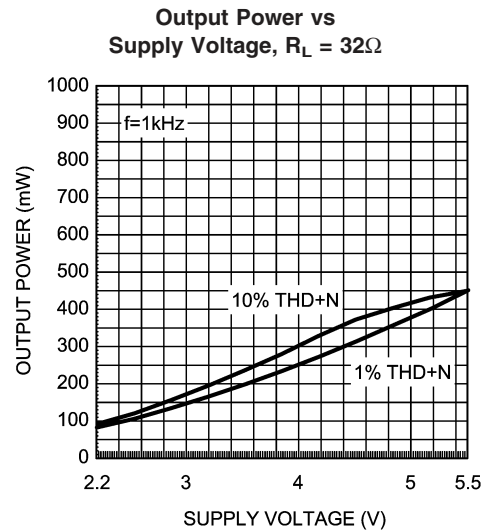
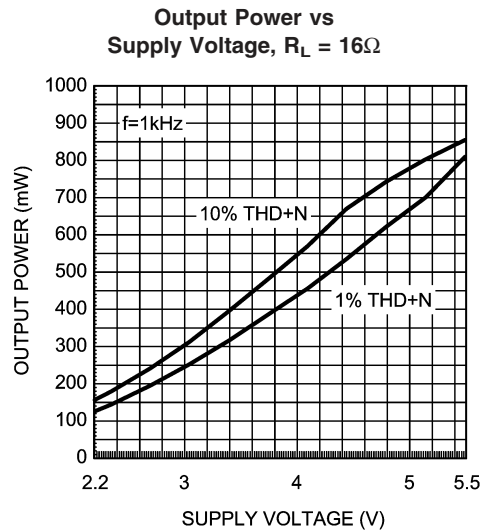

## Application Information

### EXPOSED-DAP PACKAGE PCB MOUNTING CONSIDERATION

The LM4991's exposed-DAP (die attach paddle) package (LD) provides a low thermal resistance between the die and the PCB to which the part is mounted and soldered. This allows rapid heat transfer from the die to the surrounding PCB copper traces, ground plane, and surrounding air. The result is a low voltage audio power amplifier that produces 2W at  $\leq 1\%$  THD with a  $4\Omega$  load. This high power is achieved through careful consideration of necessary thermal design. Failing to optimize thermal design may compromise the LM4991's high power performance and activate unwanted, though necessary, thermal shutdown protection.

The LD package must have its DAP soldered to a copper pad on the PCB. The DAP's PCB copper pad is connected to a large plane of continuous unbroken copper. This plane forms a thermal mass, heat sink, and radiation area. Place the heat sink area on either outside plane in the case of a

two-sided PCB, or on an inner layer of a board with more than two layers. Connect the DAP copper pad to the inner layer or backside copper heat sink area with  $4(2 \times 2)$  vias. The via diameter should be 0.012in-0.013in with a 1.27mm pitch. Ensure efficient thermal conductivity by plating through the vias.

Best thermal performance is achieved with the largest practical heat sink area. If the heatsink and amplifier share the same PCB layer, a nominal  $2.5\text{in}^2$  area is necessary for 5V operation with a  $4\Omega$  load. Heatsink areas not placed on the same PCB layer as the LM4991 should be  $5\text{in}^2$  (min) for the same supply voltage and load resistance. The last two area recommendations apply for  $25^\circ\text{C}$  ambient temperature. Increase the area to compensate for ambient temperatures above  $25^\circ\text{C}$ . The LM4991's power de-rating curve in the **Typical Performance Characteristics** shows the maximum power dissipation versus temperature. An example PCB layout for the LD package is shown in the **Demonstration Board Layout** section. Further detailed and specific information concerning PCB layout, fabrication, and mounting an

## Application Information (Continued)

LD (LLP) package is available from National Semiconductor's Package Engineering Group under application note AN1187.

### PCB LAYOUT AND SUPPLY REGULATION CONSIDERATIONS FOR DRIVING 3Ω AND 4Ω LOADS

Power dissipated by a load is a function of the voltage swing across the load and the load's impedance. As load impedance decreases, load dissipation becomes increasingly dependant on the interconnect (PCB trace and wire) resistance between the amplifier output pins and the load's connections. Residual trace resistance causes a voltage drop, which results in power dissipated in the trace and not in the load as desired. For example, 0.1Ω trace resistance reduces the output power dissipated by a 4Ω load from 2.0W to 1.95W. This problem of decreased load dissipation is exacerbated as load impedance decreases. Therefore, to maintain the highest load dissipation and widest output voltage swing, PCB traces that connect the output pins to a load must be as wide as possible.

Poor power supply regulation adversely affects maximum output power. A poorly regulated supply's output voltage decreases with increasing load current. Reduced supply voltage causes decreased headroom, output signal clipping, and reduced output power. Even with tightly regulated supplies, trace resistance creates the same effects as poor supply regulation. Therefore, making the power supply traces as wide as possible helps maintain full output voltage swing.

### BRIDGE CONFIGURATION EXPLANATION

As shown in *Figure 1*, the LM4991 has two operational amplifiers internally, allowing for a few different amplifier configurations. The first amplifier's gain is externally configurable; the second amplifier is internally fixed in a unity-gain, inverting configuration. The closed-loop gain of the first amplifier is set by selecting the ratio of  $R_f$  to  $R_i$  while the second amplifier's gain is fixed. *Figure 1* shows that the output of amplifier one serves as the input to amplifier two, which results in both amplifiers producing signals identical in magnitude, but 180° out of phase. Consequently, the differential gain for the IC is

$$A_{VD} = 2 * (R_f/R_i)$$

By driving the load differentially through outputs Vo1 and Vo2, an amplifier configuration commonly referred to as "bridged mode" is established. Bridged mode operation is different from the classical single-ended amplifier configuration where one side of its load is connected to ground.

A bridge amplifier design has a few distinct advantages over the single-ended configuration, as it provides differential drive to the load, thus doubling output swing for a specified supply voltage. Four times the output power is possible as compared to a single-ended amplifier under the same conditions. This increase in attainable output power assumes that the amplifier is not current limited or clipped. In order to choose an amplifier's closed-loop gain without causing excessive clipping, please refer to the **Audio Power Amplifier Design** section.

Another advantage of the differential bridge output is no net DC voltage across load. This results from biasing  $V_{O1}$  and  $V_{O2}$  at the same DC voltage, in this case  $V_{DD}/2$ . This eliminates the coupling capacitor that single supply, single-ended amplifiers require. Eliminating an output coupling capacitor in a single-ended configuration forces a single supply

amplifier's half-supply bias voltage across the load. The current flow created by the half-supply bias voltage increases internal IC power dissipation and may permanently damage loads such as speakers.

### POWER DISSIPATION

Power dissipation is a major concern when designing a successful amplifier, whether the amplifier is bridged or single-ended. A direct consequence of the increased power delivered to the load by a bridge amplifier is an increase in internal power dissipation. Equation 1 states the maximum power dissipation point for a bridge amplifier operating at a given supply voltage and driving a specified output load.

$$P_{D_{MAX}} = 4 * (V_{DD})^2 / (2\pi^2 R_L) \quad (1)$$

Since the LM4991 has two operational amplifiers in one package, the maximum internal power dissipation is 4 times that of a single-ended amplifier. Even with this substantial increase in power dissipation, the LM4991 does not require heatsinking under most operating conditions and output loading. From Equation 1, assuming a 5V power supply and an 8Ω load, the maximum power dissipation point is 625 mW. The maximum power dissipation point obtained from Equation 1 must not be greater than the power dissipation that results from Equation 2:

$$P_{D_{MAX}} = (T_{J_{MAX}} - T_A) / \theta_{JA} \quad (2)$$

For the SO package,  $\theta_{JA} = 140^\circ\text{C/W}$ . For the LD package soldered to a DAP pad that expands to a copper area of 1.0in<sup>2</sup> on a PCB, the LM4991's  $\theta_{JA}$  is 56°C/W.  $T_{J_{MAX}} = 150^\circ\text{C}$  for the LM4991. The  $\theta_{JA}$  can be decreased by using some form of heat sinking. The resultant  $\theta_{JA}$  will be the summation of the  $\theta_{JC}$ ,  $\theta_{CS}$ , and  $\theta_{SA}$ .  $\theta_{JC}$  is the junction to case of the package (or to the exposed DAP, as is the case with the LD package),  $\theta_{CS}$  is the case to heat sink thermal resistance and  $\theta_{SA}$  is the heat sink to ambient thermal resistance. By adding additional copper area around the LM4991, the  $\theta_{JA}$  can be reduced from its free air value for the SO package. Increasing the copper area around the LD package from 1.0in<sup>2</sup> to 2.0in<sup>2</sup> area results in a  $\theta_{JA}$  decrease to 46°C/W. Depending on the ambient temperature,  $T_A$ , and the  $\theta_{JA}$ , Equation 2 can be used to find the maximum internal power dissipation supported by the IC packaging. If the result of Equation 1 is greater than that of Equation 2, then either the supply voltage must be decreased, the load impedance increased, the  $\theta_{JA}$  decreased, or the ambient temperature reduced. For the typical application of a 5V power supply, with an 8Ω load, and no additional heatsinking, the maximum ambient temperature possible without violating the maximum junction temperature is approximately 61°C provided that device operation is around the maximum power dissipation point and assuming surface mount packaging. For the LD package in a typical application of a 5V power supply, with a 4Ω load, and 1.0in<sup>2</sup> copper area soldered to the exposed DAP pad, the maximum ambient temperature is approximately 77°C providing device operation is around the maximum power dissipation point. Internal power dissipation is a function of output power. If typical operation is not around the maximum power dissipation point, the ambient temperature can be increased. Refer to the **Typical Performance Characteristics** curves for power dissipation information for different output powers and output loading.

### POWER SUPPLY BYPASSING

As with any amplifier, proper supply bypassing is critical for low noise performance and high power supply rejection. The capacitor location on both the bypass and power supply pins should be as close to the LM4991 as possible. The capacitor

## Application Information (Continued)

connected between the bypass pin and ground improves the internal bias voltage's stability, producing improved PSRR. The improvements to PSRR increase as the bypass pin capacitor increases. Typical applications employ a 5V regulator with 10 $\mu$ F and a 0.1 $\mu$ F bypass capacitors which aid in supply stability. This does not eliminate the need for bypassing the supply nodes of the LM4991 with a 1 $\mu$ F tantalum capacitor. The selection of bypass capacitors, especially  $C_B$ , is dependent upon PSRR requirements, click and pop performance as explained in the section, **Proper Selection of External Components**, system cost, and size constraints.

### SHUTDOWN FUNCTION

In order to reduce power consumption while not in use, the LM4991 contains a shutdown pin to externally turn off the amplifier's bias circuitry. This shutdown feature turns the amplifier off when a logic high is placed on the shutdown pin. The trigger point between a logic low and logic high level is typically half- supply. It is best to switch between ground and supply to provide maximum device performance. By switching the shutdown pin to  $V_{DD}$ , the LM4991 supply current draw will be minimized in idle mode. While the device will be disabled with shutdown pin voltages less than  $V_{DD}$ , the idle current may be greater than the typical value of 0.1 $\mu$ A. In either case, the shutdown pin should be tied to a definite voltage to avoid unwanted state changes.

In many applications, a microcontroller or microprocessor output is used to control the shutdown circuitry which provides a quick, smooth transition into shutdown. Another solution is to use a single-pole, single-throw switch in conjunction with an external pull-up resistor. When the switch is closed, the shutdown pin is connected to ground and enables the amplifier. If the switch is open, then the external pull-up resistor will disable the LM4991. This scheme guarantees that the shutdown pin will not float thus preventing unwanted state changes.

### PROPER SELECTION OF EXTERNAL COMPONENTS

Proper selection of external components in applications using integrated power amplifiers is critical to optimize device and system performance. While the LM4991 is tolerant of external component combinations, consideration to component values must be used to maximize overall system quality.

The LM4991 is unity-gain stable which gives a designer maximum system flexibility. The LM4991 should be used in low gain configurations to minimize THD+N values, and maximize the signal to noise ratio. Low gain configurations require large input signals to obtain a given output power. Input signals equal to or greater than 1 V<sub>rms</sub> are available from sources such as audio codecs. Please refer to the section, **Audio Power Amplifier Design**, for a more complete explanation of proper gain selection.

Besides gain, one of the major considerations is the closed-loop bandwidth of the amplifier. To a large extent, the bandwidth is dictated by the choice of external components shown in *Figure 1*. The input coupling capacitor,  $C_i$ , forms a first order high pass filter which limits low frequency response. This value should be chosen based on needed frequency response for a few distinct reasons.

### Selection Of Input Capacitor Size

Large input capacitors are both expensive and space hungry for portable designs. Clearly, a certain sized capacitor is needed to couple in low frequencies without severe attenuation. But in many cases the speakers used in portable systems, whether internal or external, have little ability to reproduce signals below 100Hz to 150Hz. Thus, using a large input capacitor may not increase actual system performance.

In addition to system cost and size, click and pop performance is effected by the size of the input coupling capacitor,  $C_i$ . A larger input coupling capacitor requires more charge to reach its quiescent DC voltage (nominally 1/2  $V_{DD}$ ). This charge comes from the output via the feedback and is apt to create pops upon device enable. Thus, by minimizing the capacitor size based on necessary low frequency response, turn-on pops can be minimized.

Besides minimizing the input capacitor size, careful consideration should be paid to the bypass capacitor value. Bypass capacitor,  $C_B$ , is the most critical component to minimize turn-on pops since it determines how fast the LM4991 turns on. The slower the LM4991's outputs ramp to their quiescent DC voltage (nominally 1/2  $V_{DD}$ ), the smaller the turn-on pop. Choosing  $C_B$  equal to 1.0 $\mu$ F along with a small value of  $C_i$  (in the range of 0.1 $\mu$ F to 0.39 $\mu$ F), should produce a virtually clickless and popless shutdown function. While the device will function properly, (no oscillations or motorboating), with  $C_B$  equal to 0.1 $\mu$ F, the device will be much more susceptible to turn-on clicks and pops. Thus, a value of  $C_B$  equal to 1.0 $\mu$ F is recommended in all but the most cost sensitive designs.

## AUDIO POWER AMPLIFIER DESIGN

### Design a 1W/8 $\Omega$ Audio Amplifier

Given:

Power Output	1 Wrms
Load Impedance	8 $\Omega$
Input Level	1 Vrms
Input Impedance	20 k $\Omega$
Bandwidth	100 Hz–20 kHz $\pm$ 0.25 dB

A designer must first determine the minimum supply rail to obtain the specified output power. By extrapolating from the Output Power vs Supply Voltage graphs in the **Typical Performance Characteristics** section, the supply rail can be easily found. A second way to determine the minimum supply rail is to calculate the required  $V_{\text{opeak}}$  using Equation 3 and add the output voltage. Using this method, the minimum supply voltage would be ( $V_{\text{opeak}} + (V_{\text{ODTOP}} + V_{\text{ODBOT}})$ ), where  $V_{\text{ODBOT}}$  and  $V_{\text{ODTOP}}$  are extrapolated from the Dropout Voltage vs Supply Voltage curve in the **Typical Performance Characteristics** section.

$$V_{\text{opeak}} = \sqrt{(2R_L P_O)} \quad (3)$$

Using the Output Power vs Supply Voltage graph for an 8 $\Omega$  load, the minimum supply rail is 4.6V. But since 5V is a standard voltage in most applications, it is chosen for the supply rail. Extra supply voltage creates headroom that allows the LM4991 to reproduce peaks in excess of 1W without producing audible distortion. At this time, the designer

## Application Information (Continued)

must make sure that the power supply choice along with the output impedance does not violate the conditions explained in the **Power Dissipation** section.

Once the power dissipation equations have been addressed, the required differential gain can be determined from Equation 4.

$$A_{VD} \geq \sqrt{(P_O R_L)} / (V_{IN}) = V_{orms} / V_{inrms} \quad (4)$$

$$R_f / R_i = A_{VD} / 2 \quad (5)$$

From Equation 4, the minimum  $A_{VD}$  is 2.83; use  $A_{VD} = 3$ .

Since the desired input impedance was  $20k\Omega$ , and with a  $A_{VD}$  impedance of 2, a ratio of 1.5:1 of  $R_f$  to  $R_i$  results in an allocation of  $R_i = 20k\Omega$  and  $R_f = 30k\Omega$ . The final design step is to address the bandwidth requirements which must be

stated as a pair of  $-3dB$  frequency points. Five times away from a  $-3dB$  point is  $0.17dB$  down from passband response which is better than the required  $\pm 0.25dB$  specified.

$$f_L = 100Hz / 5 = 20Hz$$

$$f_H = 20kHz * 5 = 100kHz$$

As stated in the **External Components** section,  $R_i$  in conjunction with  $C_i$  create a highpass filter.

$$C_i \geq 1 / (2\pi * 20k\Omega * 20Hz) = 0.397\mu F; \text{ use } 0.39\mu F$$

The high frequency pole is determined by the product of the desired frequency pole,  $f_H$ , and the differential gain,  $A_{VD}$ . With a  $A_{VD} = 3$  and  $f_H = 100kHz$ , the resulting GBWP =  $150kHz$  which is much smaller than the LM4991 GBWP of  $4MHz$ . This figure displays that if a designer has a need to design an amplifier with a higher differential gain, the LM4991 can still be used without running into bandwidth limitations.

**Physical Dimensions** inches (millimeters) unless otherwise noted

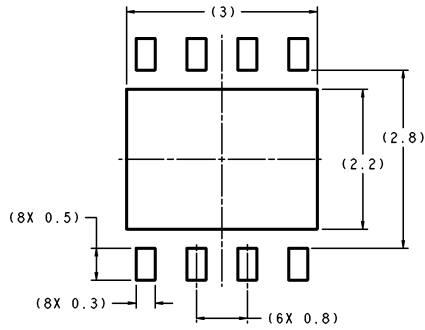

DIMENSIONS ARE IN MILLIMETERS

RECOMMENDED LAND PATTERN  
1:1 RATION WITH PKG SOLDER PADS

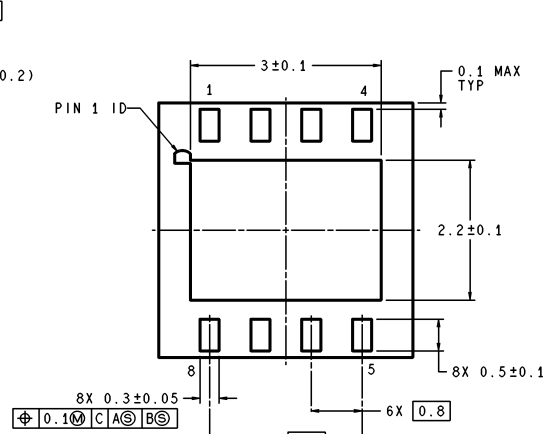
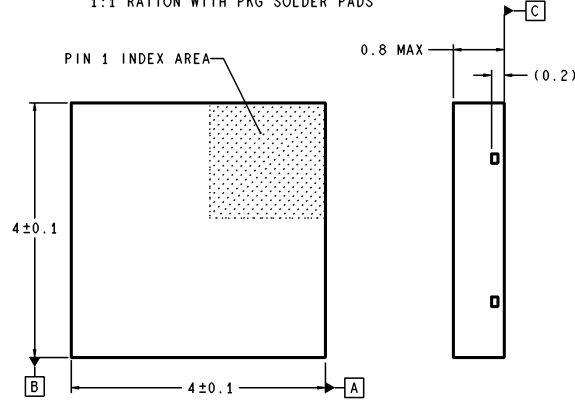

LDC08A (Rev A)

Order Number LM4991LD  
See NS Package Number LDC08A

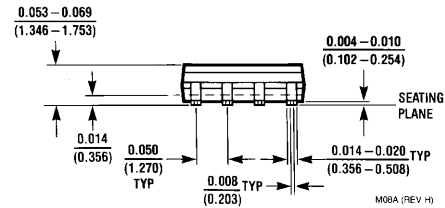
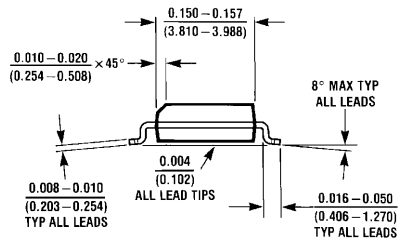
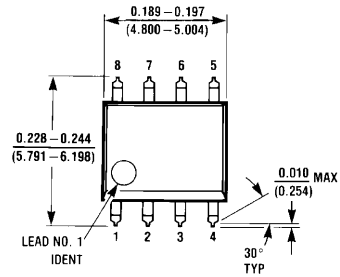

M08A (REV H)

Order Number LM4991MA  
NS Package Number M08A

## Notes

### LIFE SUPPORT POLICY

NATIONAL'S PRODUCTS ARE NOT AUTHORIZED FOR USE AS CRITICAL COMPONENTS IN LIFE SUPPORT DEVICES OR SYSTEMS WITHOUT THE EXPRESS WRITTEN APPROVAL OF THE PRESIDENT AND GENERAL COUNSEL OF NATIONAL SEMICONDUCTOR CORPORATION. As used herein:

1. Life support devices or systems are devices or systems which, (a) are intended for surgical implant into the body, or (b) support or sustain life, and whose failure to perform when properly used in accordance with instructions for use provided in the labeling, can be reasonably expected to result in a significant injury to the user.
2. A critical component is any component of a life support device or system whose failure to perform can be reasonably expected to cause the failure of the life support device or system, or to affect its safety or effectiveness.



**National Semiconductor**  
Americas Customer  
Support Center  
Email: [new.feedback@nsc.com](mailto:new.feedback@nsc.com)  
Tel: 1-800-272-9959

[www.national.com](http://www.national.com)

**National Semiconductor**  
Europe Customer Support Center  
Fax: +49 (0) 180-530 85 86  
Email: [europe.support@nsc.com](mailto:europe.support@nsc.com)  
Deutsch Tel: +49 (0) 69 9508 6208  
English Tel: +44 (0) 870 24 0 2171  
Français Tel: +33 (0) 1 41 91 8790

**National Semiconductor**  
Asia Pacific Customer  
Support Center  
Email: [ap.support@nsc.com](mailto:ap.support@nsc.com)

**National Semiconductor**  
Japan Customer Support Center  
Fax: 81-3-5639-7507  
Email: [jpn.feedback@nsc.com](mailto:jpn.feedback@nsc.com)  
Tel: 81-3-5639-7560