

GP1S36

Photointerrupter for Detecting Tilt Direction

Features

1. Subminiature (4.0×4.2×3.8mm)
(with built-in super compact ball for detecting tilt direction)
2. 2-phase output type
3. Able to detect the tilt direction of both side ($\pm 90^\circ$) by the position of rolling ball.
4. High reliability due to non-contact structure

Applications

1. Digital cameras
2. Camcoders

Absolute Maximum Ratings (T_a=25°C)

	Parameter	Symbol	Rating	Unit
Input	Forward current	I _F	50	mA
	Reverse voltage	V _R	6	V
	Power dissipation	P	75	mW
Output	Collector-emitter voltage	V _{CE1O}	35	V
		V _{CE2O}		
	Emitter-collector voltage	V _{E1CO}	6	V
		V _{E2CO}		
	Collector current	I _C	20	mA
Collector Power dissipation	P _C	75	mW	
Total power dissipation		P _{tot}	100	mW
Operating temperature		T _{opr}	-25 to +85	°C
Storage temperature		T _{stg}	-40 to +100	°C
*1 Soldering temperature 1		T _{sol}	260	°C
*2 Soldering temperature 2		T _{sol}	320	°C

*1 For MAX. 5s

*2 For MAX. 2s at the position of 0.8mm from the bottom face of resin package by hand soldering.

Outline Dimensions

(Unit : mm)

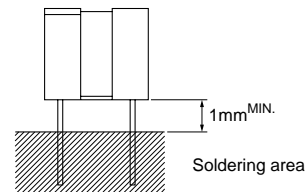
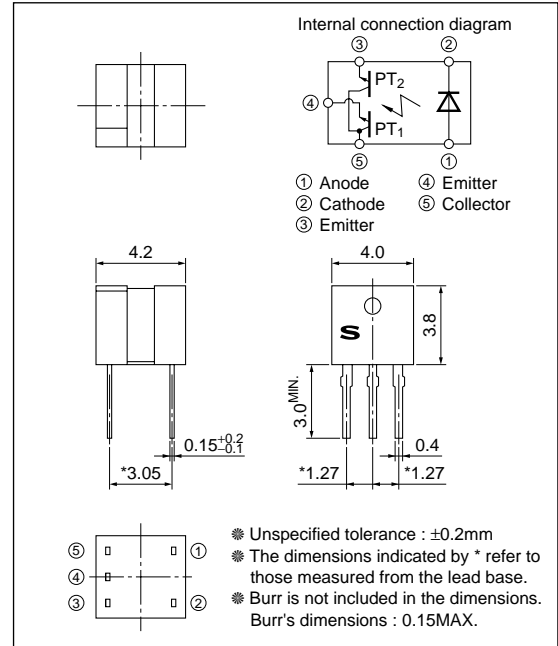

■ Electro-optical Characteristics

(Ta=25°C)

Parameter	Symbol	Conditions	MIN.	TYP.	MAX.	Unit	
Input	Forward voltage	V_F	-	1.2	1.4	V	
	Reverse current	I_R	-	-	10	μA	
*3 Output	Collector dark current	I_{CEO}	-	-	100	nA	
*3 Coupling Characteristics	Collector current	I_C	$V_{CE}=5V, I_f=5mA$	60	-	360	μA
	*4 Leak current	I_{LEAK}	$V_{CE}=5V, I_f=5mA$	-	-	15	μA
	Response time	Rise time	$V_{CE}=5V, I_C=100\mu A$ $R_L=1\ 000\Omega$	-	50	150	μs
		Fall time		-	50	150	μs
	Collector-emitter saturation voltage	$V_{CE(sat)}$	$I_f=10mA, I_C=60\mu A$	-	-	0.4	V

*3 Output and coupling characteristics are common to the both phototransistors.

*4 Characteristics except leak current is measured at $\theta=0^\circ, \phi=0^\circ$.

Leak current is the output current of transistor when $\theta=\pm 90^\circ, \phi=0^\circ$ and $I_C=OFF$.

■ Detecting Angle Characteristics

θ	-90°	↔	-75°	↔	-15°	↔	+15°	↔	+75°	↔	+90°
I_{C1}	ON				*5	OFF					
I_{C2}	OFF	*5	ON								

* Conditions : $I_f=5mA, V_{CC}=5V, \phi<=\pm 5^\circ$

*5 Indefinite

I_{C1} : Output current of phototransistors PT1

I_{C2} : Output current of phototransistors PT2

θ : Device condition : Refer to the figure

ϕ : Device condition : Refer to the figure

ON : Output current of phototransistors : 60 μA or more

OFF : Output current of phototransistors : 15 μA or less

* Output current of ON/OFF is output when device is at a standstill

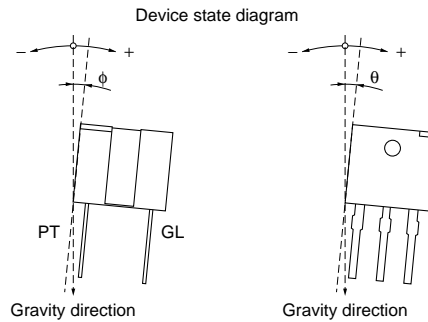

■ Supplement

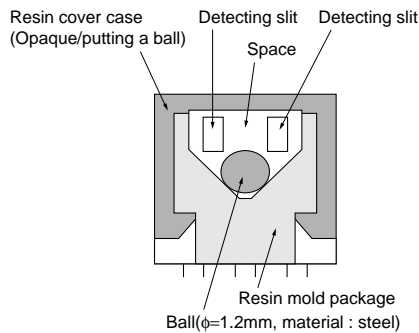

<90°rotation>

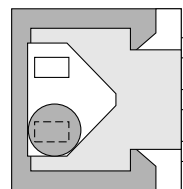

<Viewing from detecting side>

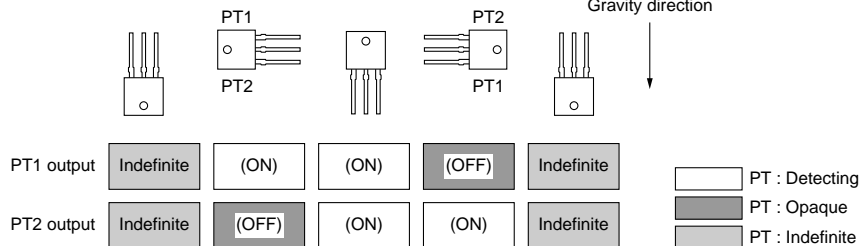

Fig.1 Forward Current vs. Ambient Temperature

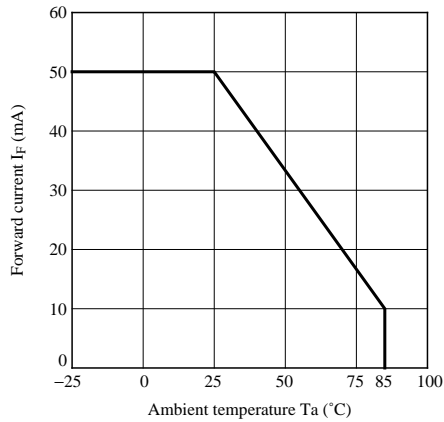

Fig.2 Power Dissipation vs. Ambient Temperature

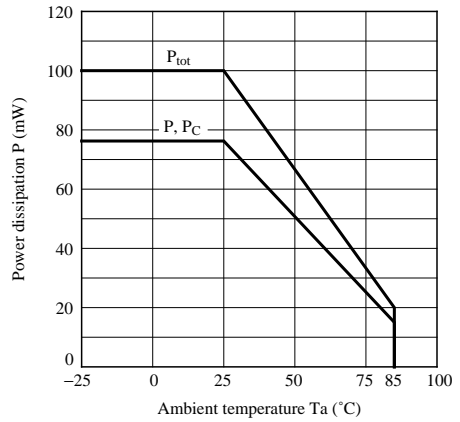

Fig.3 Forward Current vs. Forward Voltage

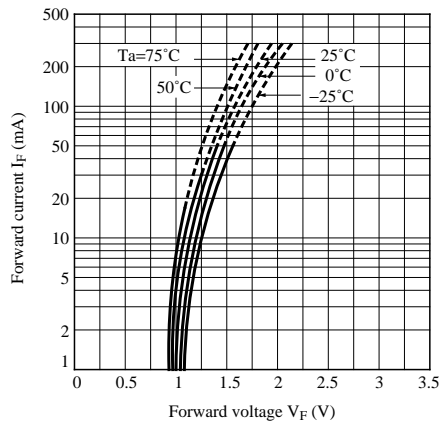

Fig.4 Collector Current vs. Forward Current

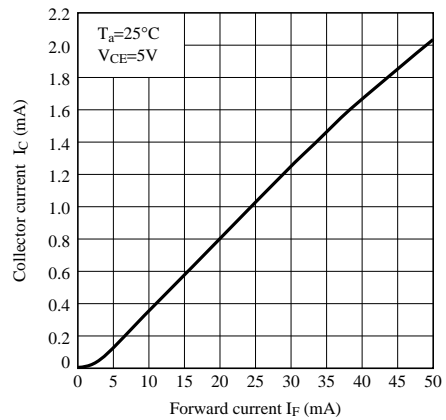

Fig.5 Collector Current vs. Collector-emitter Voltage

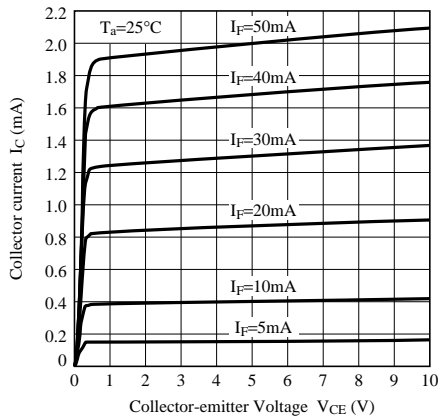

Fig.6 Relative Collector Current vs. Ambient Temperature

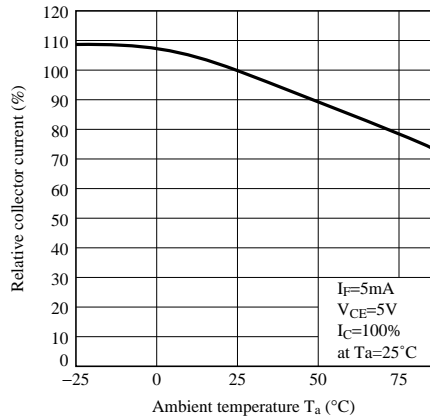

Fig.7 Collector-emitter Saturation Voltage vs. Ambient Temperature

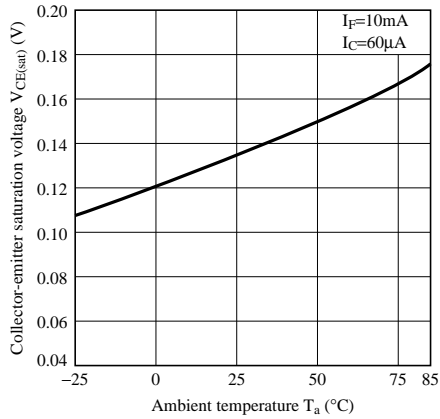

Fig.8 Response Time vs. Load Resistance

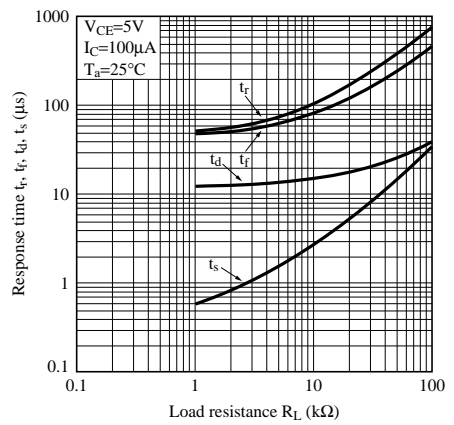

Fig.9 Collector Dark Current vs. Ambient Temperature

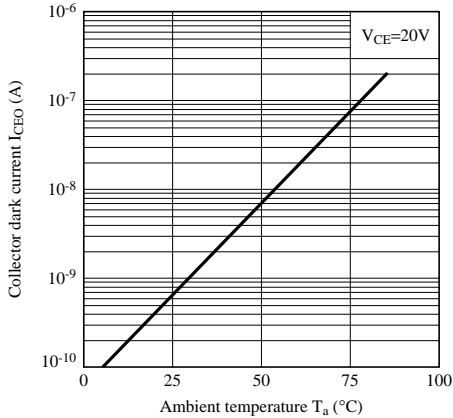
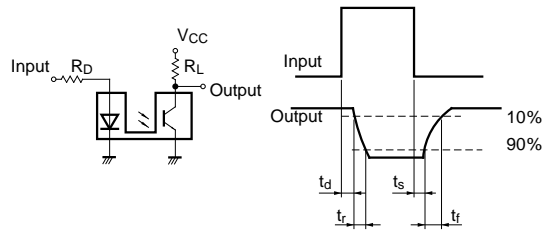

Fig.10 Test Circuit for Response Time



NOTICE

- The circuit application examples in this publication are provided to explain representative applications of SHARP devices and are not intended to guarantee any circuit design or license any intellectual property rights. SHARP takes no responsibility for any problems related to any intellectual property right of a third party resulting from the use of SHARP's devices.
- Contact SHARP in order to obtain the latest device specification sheets before using any SHARP device. SHARP reserves the right to make changes in the specifications, characteristics, data, materials, structure, and other contents described herein at any time without notice in order to improve design or reliability. Manufacturing locations are also subject to change without notice.
- Observe the following points when using any devices in this publication. SHARP takes no responsibility for damage caused by improper use of the devices which does not meet the conditions and absolute maximum ratings to be used specified in the relevant specification sheet nor meet the following conditions:
 - (i) The devices in this publication are designed for use in general electronic equipment designs such as:
 - Personal computers
 - Office automation equipment
 - Telecommunication equipment [terminal]
 - Test and measurement equipment
 - Industrial control
 - Audio visual equipment
 - Consumer electronics
 - (ii) Measures such as fail-safe function and redundant design should be taken to ensure reliability and safety when SHARP devices are used for or in connection with equipment that requires higher reliability such as:
 - Transportation control and safety equipment (i.e., aircraft, trains, automobiles, etc.)
 - Traffic signals
 - Gas leakage sensor breakers
 - Alarm equipment
 - Various safety devices, etc.
 - (iii) SHARP devices shall not be used for or in connection with equipment that requires an extremely high level of reliability and safety such as:
 - Space applications
 - Telecommunication equipment [trunk lines]
 - Nuclear power control equipment
 - Medical and other life support equipment (e.g., scuba).
- Contact a SHARP representative in advance when intending to use SHARP devices for any "specific" applications other than those recommended by SHARP or when it is unclear which category mentioned above controls the intended use.
- If the SHARP devices listed in this publication fall within the scope of strategic products described in the Foreign Exchange and Foreign Trade Control Law of Japan, it is necessary to obtain approval to export such SHARP devices.
- This publication is the proprietary product of SHARP and is copyrighted, with all rights reserved. Under the copyright laws, no part of this publication may be reproduced or transmitted in any form or by any means, electronic or mechanical, for any purpose, in whole or in part, without the express written permission of SHARP. Express written permission is also required before any use of this publication may be made by a third party.
- Contact and consult with a SHARP representative if there are any questions about the contents of this publication.