

# Hi-Rel Slotted Optical Switches

## Types OPB870N, OPB870L, OPB870P, OPB870T Series

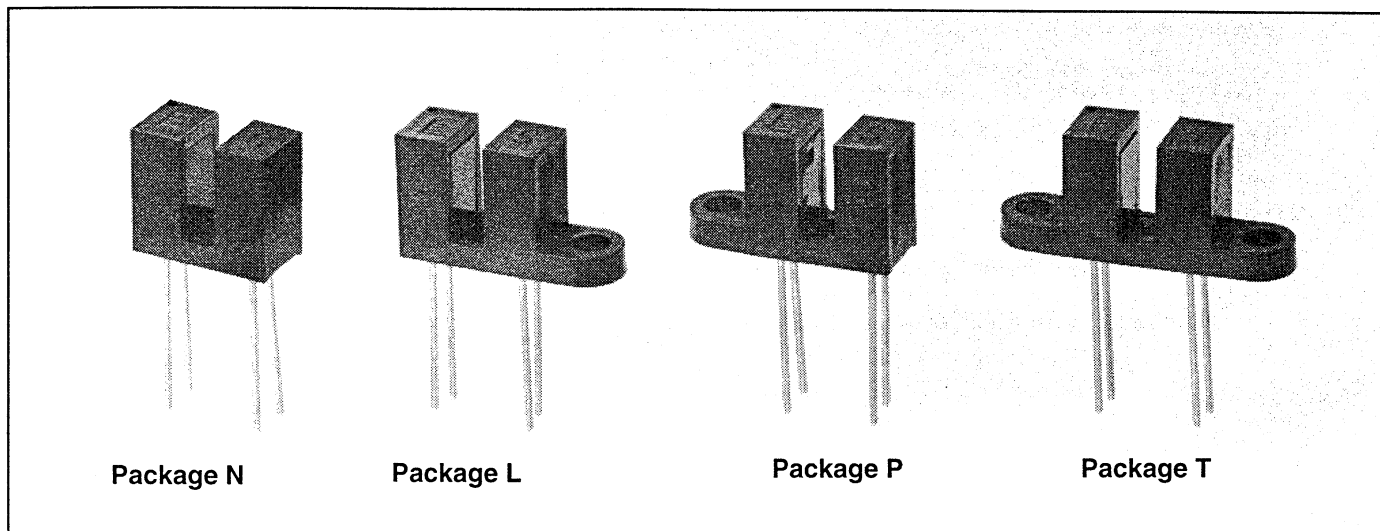

### Features

- Non-contact switching
- Choice of apertures
- Choice of minimum  $I_{C(ON)}$
- Hermetically sealed components
- Components processed to Optek's screening program patterned after MIL-PRF-19500 for TX and TXV devices
- S level processing available
- Plastic meets NASA publication 1124

### Description

The OPB870 series slotted optical switch consists of a gallium aluminum arsenide LED and a silicon phototransistor soldered into a printed circuit board then mounted in a high temperature plastic housing on opposite sides of a 0.125 inch (3.18 mm) wide slot. Phototransistor switching takes place whenever an opaque object passes through the slot. Options include phototransistor aperture widths of 0.050 inches (1.27 mm) or 0.010 inches (0.25 mm) for high resolution positioning sensing.

The OPB870 hi-rel series uses optoelectronic components that have been processed and tested as either TX or TXV components per MIL-PRF-19500. Typical screening and lot acceptance tests are provided on page 13-4.

### Absolute Maximum Ratings ( $T_A = 25^\circ\text{C}$ unless otherwise noted)

Operating Temperature Range	-65° C to +125° C
Storage Temperature Range	-65° C to +150° C
Lead Soldering Temperature [1/16 inch (1.6 mm) from case 5 sec. with soldering iron]	240° C
<b>Input Diode</b>	
Forward DC Current	50 mA
Reverse Voltage	2.0 V
Power Dissipation	100 mW <sup>(2)</sup>

### Output Phototransistor

Collector-Emitter Voltage	50 V
Emitter-Collector Voltage	7.0 V
Power Dissipation	100 mW <sup>(2)</sup>

### Notes:

- (1) Duration can be extended to 10 sec. max. when flow soldering.
- (2) Derate linearly 1.00 mW/°C above 25° C.
- (3) Methanol or isopropanol are recommended as cleaning agents.

### Part Number Guide

OPB 87X X 5X XX

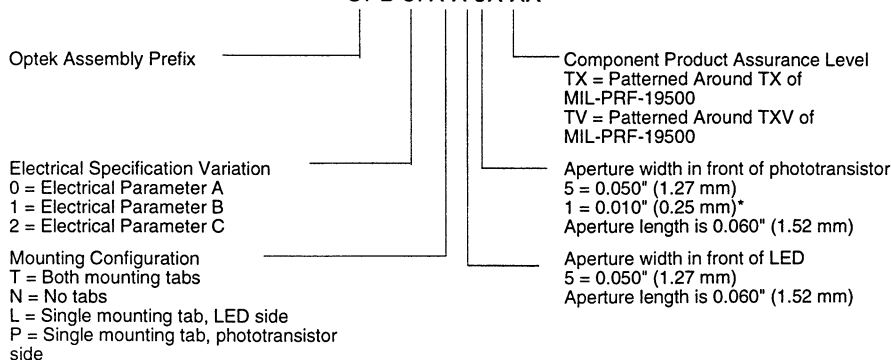

\*Parameter "A" only

# Type OPB870 Series

Electrical Characteristics ( $T_A = 25^\circ\text{C}$  unless otherwise noted)

Symbol	Parameter	Min	Typ	Max	Units	Test Conditions	
<b>Input Diode</b>							
$V_F$	Forward Voltage <sup>(4)</sup>	1.00	1.35	1.70	V	$I_F = 20.0\text{ mA}$	
		1.20	1.55	1.90	V	$I_F = 20.0\text{ mA}, T_A = -55^\circ\text{C}$	
		0.80	1.20	1.60	V	$I_F = 20.0\text{ mA}, T_A = 100^\circ\text{C}$	
$I_R$	Reverse Current		0.1	10	$\mu\text{A}$	$V_R = 2.0\text{ V}$	
<b>Output Phototransistor</b>							
$V_{(BR)CEO}$	Collector-Emitter Breakdown Voltage	50	110		V	$I_C = 1.0\text{ mA}, I_F = 0$	
$V_{(BR)ECO}$	Emitter-Collector Breakdown Voltage	7.0	10.0		V	$I_E = 100\ \mu\text{A}, I_F = 0$	
$I_{C(off)}$	Collector-Emitter Dark Current		0.2	100	nA	$V_{CE} = 10.0\text{ V}, I_F = 0$	
			10	100	$\mu\text{A}$	$V_{CE} = 10.0\text{ V}, I_F = 0, T_A = 100^\circ\text{C}$	
<b>Coupled</b>							
$I_{C(ON)}$	On-State Collector Current <sup>(4)</sup>						
	Parameter A	OPB870	500		$\mu\text{A}$	$V_{CE} = 10.0\text{ V}, I_F = 20.0\text{ mA}$	
		OPB870	200		$\mu\text{A}$	$V_{CE} = 10.0\text{ V}, I_F = 20.0\text{ mA}, T_A = -55^\circ\text{C}$	
		OPB870	200		$\mu\text{A}$	$V_{CE} = 10.0\text{ V}, I_F = 20.0\text{ mA}, T_A = 100^\circ\text{C}$	
	Parameter B	OPB871	1000		$\mu\text{A}$	$V_{CE} = 5.0\text{ V}, I_F = 10.0\text{ mA}$	
		OPB871	400		$\mu\text{A}$	$V_{CE} = 5.0\text{ V}, I_F = 10.0\text{ mA}, T_A = -55^\circ\text{C}$	
		OPB871	400		$\mu\text{A}$	$V_{CE} = 5.0\text{ V}, I_F = 10.0\text{ mA}, T_A = 100^\circ\text{C}$	
	Parameter C	OPB872	1800		$\mu\text{A}$	$V_{CE} = 0.4\text{ V}, I_F = 20.0\text{ mA}$	
		OPB872	800		$\mu\text{A}$	$V_{CE} = 0.4\text{ V}, I_F = 20.0\text{ mA}, T_A = -55^\circ\text{C}$	
		OPB872	800		$\mu\text{A}$	$V_{CE} = 0.4\text{ V}, I_F = 20.0\text{ mA}, T_A = 100^\circ\text{C}$	
$V_{CE(SAT)}$	Collector-Emitter Saturation Voltage	OPB870		0.20	0.30	V	$I_C = 400\ \mu\text{A}, I_F = 20.0\text{ mA}$
		OPB871		0.20	0.30	V	$I_C = 800\ \mu\text{A}, I_F = 10.0\text{ mA}$
		OPB872		0.20	0.30	V	$I_C = 1800\ \mu\text{A}, I_F = 20.0\text{ mA}$
$t_r$	Output Rise Time	OPB870		8.0	15.0	$\mu\text{s}$	$V_{CC} = 10.0\text{ V}, I_F = 20.0\text{ mA}, R_L = 1000\ \Omega$
		OPB871		12.0	20.0	$\mu\text{s}$	
		OPB872		12.0	20.0	$\mu\text{s}$	
$t_f$	Output Fall Time	OPB870		8.0	15.0	$\mu\text{s}$	$V_{CC} = 10.0\text{ V}, I_F = 20.0\text{ mA}, R_L = 1000\ \Omega$
		OPB871		12.0	20.0	$\mu\text{s}$	
		OPB872		12.0	20.0	$\mu\text{s}$	

(4) Measurement is taken during the last 500  $\mu\text{s}$  of a single 1.0 ms test pulse. Heating due to increased pulse rate or pulse width can cause change in measurement results.

Optek reserves the right to make changes at any time in order to improve design and to supply the best product possible.  
 Optek Technology, Inc. 1215 W. Crosby Road Carrollton, Texas 75006 (972)323-2200 Fax (972)323-2396

# Type OPB870 Series

## Package Configuration T

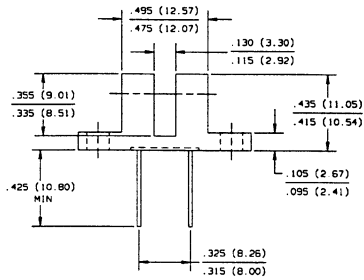
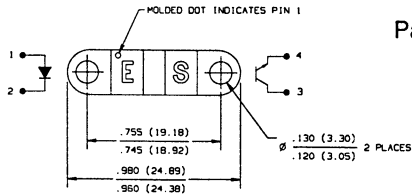

DIMENSIONS ARE IN INCHES (MILLIMETERS)

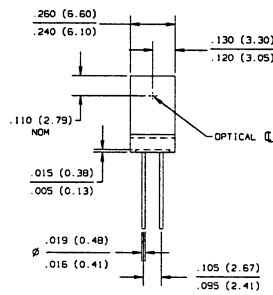

## Package Configuration N

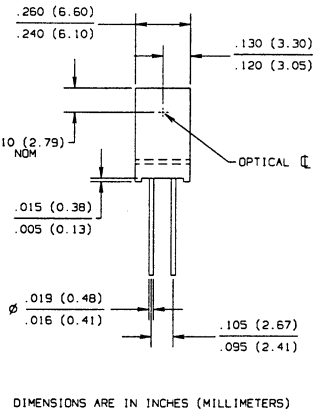
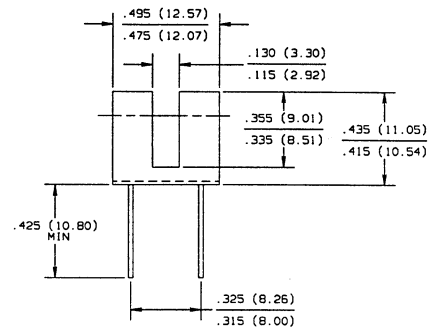
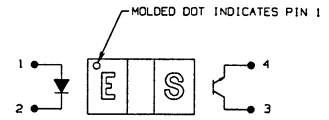

## Package Configuration P

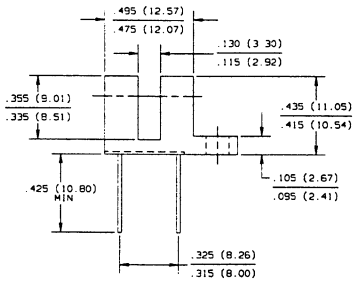
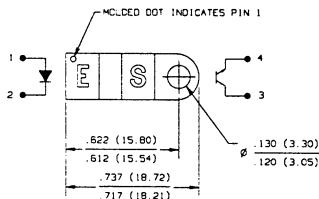

DIMENSIONS ARE IN INCHES (MILLIMETERS)

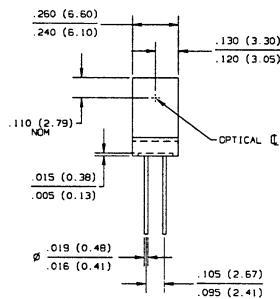

## Package Configuration L

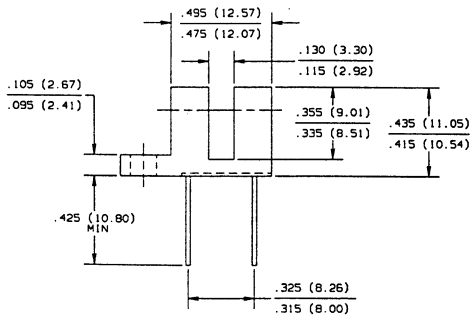
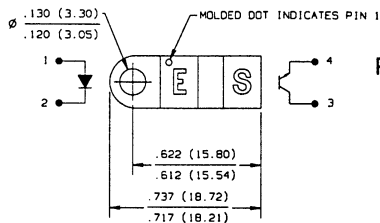

DIMENSIONS ARE IN INCHES (MILLIMETERS)

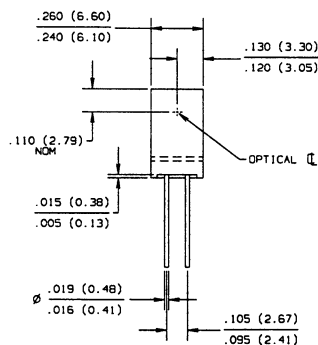

# Type OPB870 Series

## Typical Performance Curves

**Relative Output Current vs Time**

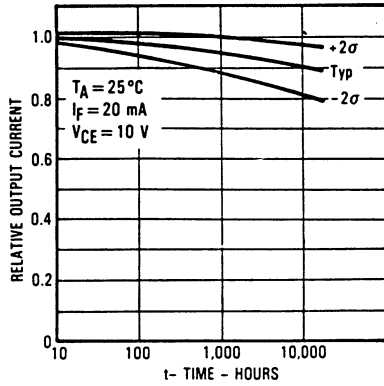

**Normalized Output Current vs Ambient Temperature**

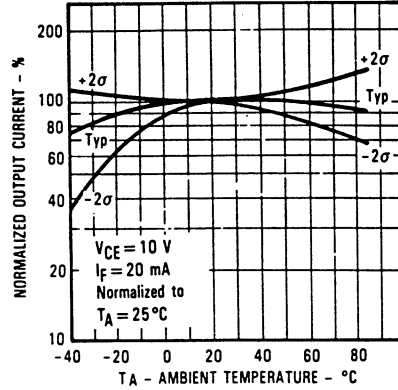

**Reduction in Output Current Due to LED Heating vs Forward Current**

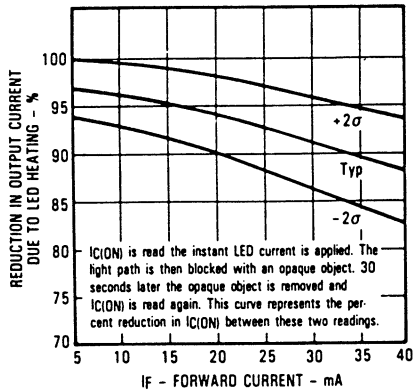

**Normalized Output Current vs Input Current**

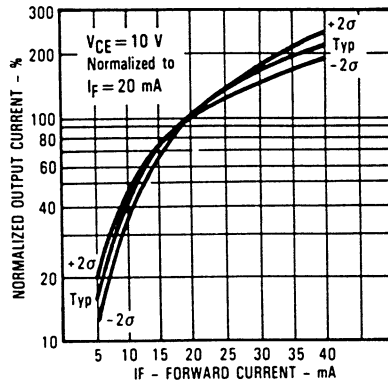

**Rise and Fall Time vs Load Resistance**

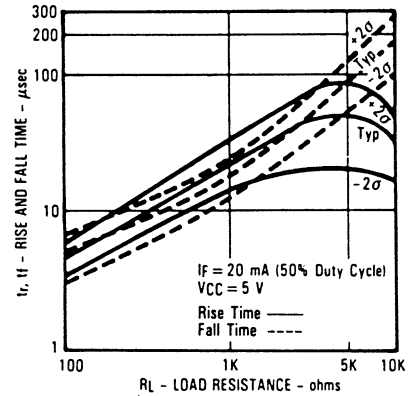

HI-RELIABLE OPTO COMPONENTS